

Rittal – The System.

Faster – better – everywhere.



VX25.
**SYSTEM
PERFECTION.**

ENCLOSURES

POWER DISTRIBUTION

CLIMATE CONTROL

IT INFRASTRUCTURE

SOFTWARE & SERVICES

FRIEDHELM LOH GROUP



Rittal – The System.

Faster – better – everywhere.



ENCLOSURES

POWER DISTRIBUTION

CLIMATE CONTROL

FRIEDHELM LOH GROUP

VX25. SYSTEM PERFECTION.



CONTENTS

System benefits	from page	20
Frames/punched sections	from page	26
Doors/walls	from page	32
Base/plinths	from page	38
Baying	from page	42
Mounting plate	from page	46
Ordering information		
– Baying enclosure system VX25	from page	52
– System accessories	from page	82
Technical details	from page	216



IT INFRASTRUCTURE

SOFTWARE & SERVICES





ENCLOSURES

POWER DISTRIBUTION

CLIMATE CONTROL

VX25.
SYSTEM
PERFECTION.



THE ONE-STOP SUPPLIERS

One partner for everything – Rittal serves the entire value creation chain for enclosure manufacturing. This unrivalled pervasiveness helps to boost efficiency and maintain consistently high standards.

The entire value chain from a single source – Comprehensive digitisation and automation steps are also required in panel building and switchgear manufacturing in order to meet the requirements of smart factories and Industry 4.0. Rittal facilitates the seamless integration of engineering, systems and automation with a perfect blend of planning aids, system products and machining solutions. Experience the optimum value chain live at the Rittal Innovation Center in Haiger.

IT INFRASTRUCTURE

SOFTWARE & SERVICES





Engineering

With Rittal and Eplan engineering tools, you can be sure that the data you need is always available at the right time, in the right place, and in the required quality and depth. This enables you to create a virtual prototype.

Benefit: Unrivalled efficiency.

ENCLOSURES

POWER DISTRIBUTION

CLIMATE CONTROL

VX25.
SYSTEM
PERFECTION.



THE WORKFLOW PARTNERS



System

Rittal's comprehensive modular system accommodates every requirement, however individual, and includes enclosure, power distribution, climate control and IT infrastructure systems.

Benefit: Maximum flexibility.

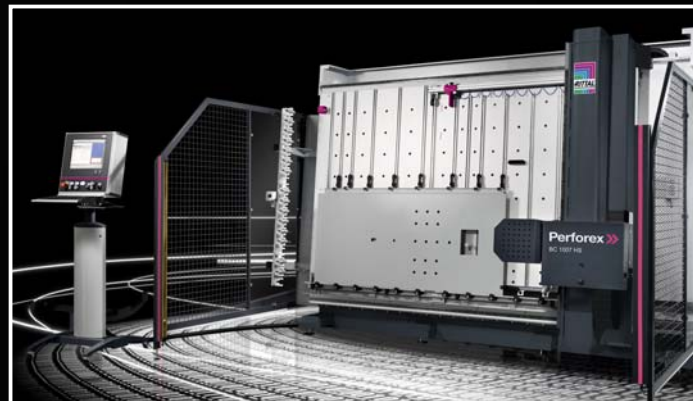

Automation

Boosting efficiency through automation – Rittal Automation Systems supplies all the machines and equipment for this.

Benefit: Exceptional competitiveness.

IT INFRASTRUCTURE

SOFTWARE & SERVICES





ENCLOSURES

POWER DISTRIBUTION

CLIMATE CONTROL

VX25.
SYSTEM
PERFECTION.



THE INVENTORS

Ideas to boost efficiency – It all began with the first standardised enclosure, which led to immediate time and money savings for Rittal's customers. It revolutionised the industry. Even today, improving efficiency for users is still our primary objective. Rittal pursues this goal with passion and inventiveness, as evidenced by our approx. 2,000 patents. The latest example is our VX25 large enclosure system.

Innovations for improved workflows – Rittal develops new solutions to keep its customers at the cutting edge of technology. The VX25 is a new platform which can be integrated seamlessly into fully automated switchgear and controlgear manufacturing. Workflows become more transparent, faster, and more efficient. The digital twin becomes a reality.

IT INFRASTRUCTURE

SOFTWARE & SERVICES



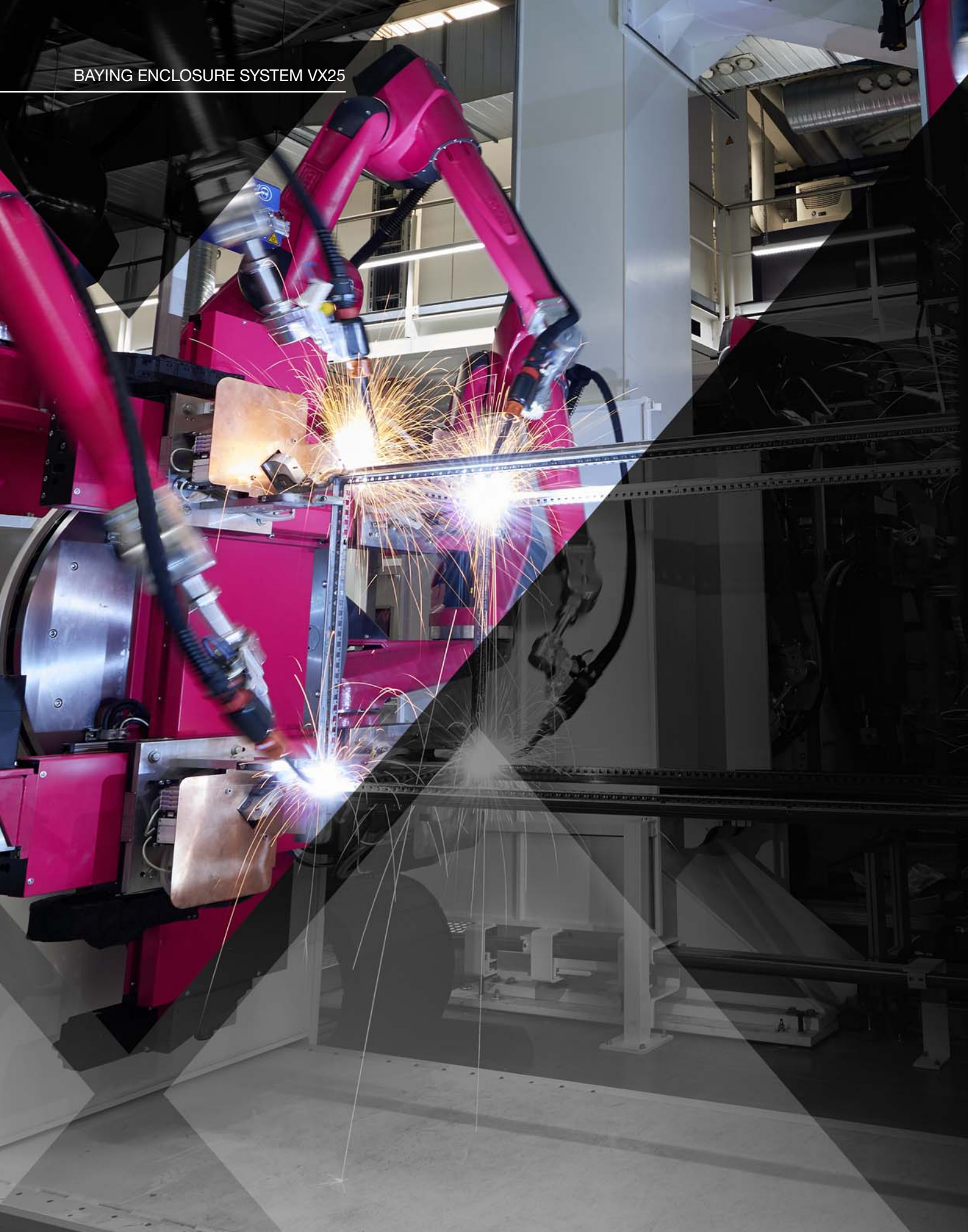

ENCLOSURES

POWER DISTRIBUTION

CLIMATE CONTROL

VX25.
SYSTEM
PERFECTION.



THE MOVERS AND SHAKERS

Manufactured to Industry 4.0 – Made in Germany. The VX25 was developed in Germany, and is also manufactured there to 4.0 standards, using world-class, digitally networked technology. Each day, we produce 15,000 enclosures at 8 production sites on 3 continents, in a consistently high quality and offering unparalleled flexibility and availability.

World-renowned quality –The VX25, with its internationally recognised approvals and certifications, is ideal for global use and meets the highest quality benchmarks. Compliance with global standards is ensured by stringent testing to international regulations, plus regular production inspections by external test institutes.

IT INFRASTRUCTURE

SOFTWARE & SERVICES





Materialflussgruppe
Partnerschaft gewinnt

Materialflussgruppe
Partnerschaft gewinnt

ENCLOSURES

POWER DISTRIBUTION

CLIMATE CONTROL

VX25.
SYSTEM
PERFECTION.



THE PROBLEM SOLVERS

Fast delivery off the shelf – Rittal's products, including the VX25, are generally available within 24 hours in Europe, and within 48 hours worldwide. To this end, Rittal operates 8 production sites, 64 subsidiaries and approx. 80 sales and logistics centres worldwide. The benefits for Rittal customers include greater flexibility in terms of planning, scheduling and production, less storage space requirements, and reduced capital tie-up.

Fast global service – If you opt for the VX25, you can rely on Rittal's global service operation, dedicated to ensuring plant availability, identifying potential savings, and resolving technical problems in an uncomplicated fashion. The Rittal service network is implemented and maintained by 4 international service hubs, more than 1,000 service specialists and a round-the-clock Rittal service hotline.

IT INFRASTRUCTURE

SOFTWARE & SERVICES





ENCLOSURES

POWER DISTRIBUTION

CLIMATE CONTROL

VX25.
SYSTEM
PERFECTION.



THE GLOBAL MARKET LEADERS

Industry insider – The VX25 is revolutionary when it comes to flexibility and adaptability. And there's a good reason for this: Rittal has an in-depth understanding of the requirements of the various markets, and boasts decades of experience as a partner to all sectors of industry, from automotive, to food, to the aerospace industry.

One-stop supplier – The VX25 is part of the comprehensive Rittal system, available worldwide. It provides everything you need from a modern enclosure manufacturer, from engineering tools, to enclosures, power distribution and climate control, as well as the full range of accessories for assembling and configuring enclosures.

IT INFRASTRUCTURE

SOFTWARE & SERVICES



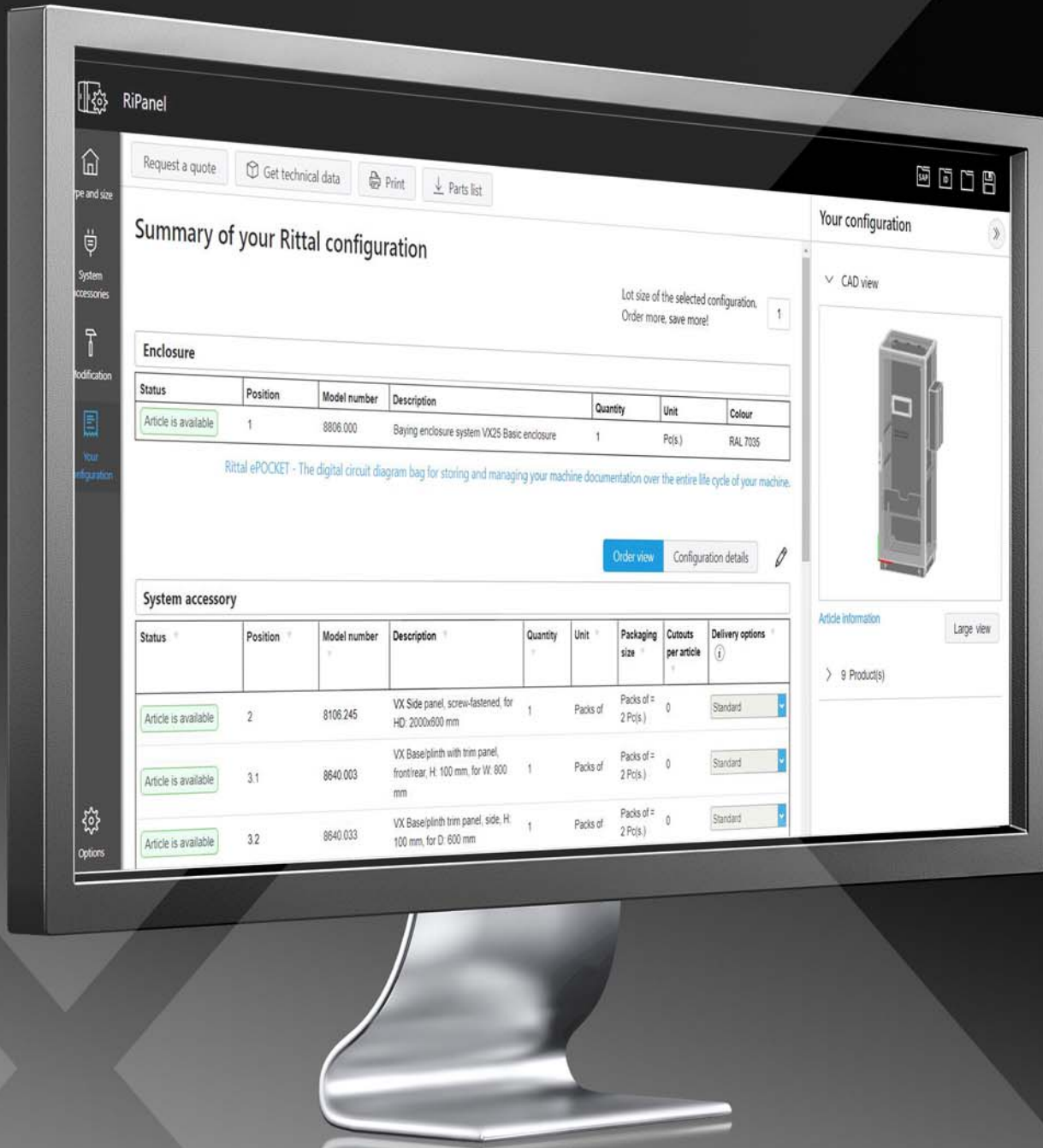

ENCLOSURES

POWER DISTRIBUTION

CLIMATE CONTROL

VX25.
SYSTEM
PERFECTION.



THE TIME SAVERS

Intuitive configuration translates into time savings of up to 95% – To this end, Rittal has devised an online tool, RiPanel. Once you have selected your enclosure, it allows you to precisely position your custom-fit accessories.

Define cut-outs and drilled holes automatically – Even at the configuration stage, the cut-outs required in the panels may be defined with millimetre accuracy and transferred into the plans.

The benefits for you – Finally, the system generates CAD files. Alongside the fully configured design, these files also contain all the data needed to control the Perforex machining centre, making NC-controlled machining of enclosure panels viable even with small batch sizes.

IT INFRASTRUCTURE

SOFTWARE & SERVICES





ENCLOSURES

POWER DISTRIBUTION

CLIMATE CONTROL



THE BENEFIT PROVIDERS

More digitisation

The QR code on all machinable enclosure panels permits fully automated incorporation into the production workflow, for seamless digital monitoring at every stage, from the incoming merchandise through to completion.

More labour-saving

The new hinge is designed for simple, tool-free installation and removal of the doors, eliminating the need to separately unlock and lock the hinge bolts.

More reduction of parts

The frame section, which is identical both horizontally and vertically, allows uniform punched sections and rails to be used throughout, reducing the number of part variants by up to 40%.

More installation security

The stable base frame enables the direct, secure attachment of the enclosure from the inside. The large opening makes it simple to install cables with large bending radii from the mounting plate to the base.

More assembly-friendly

The frame section enables completely unhindered assembly, even from the outside, so that punched sections can be retro-fitted in areas that are no longer accessible from the inside.

IT INFRASTRUCTURE

SOFTWARE & SERVICES





SYSTEM ADVANTAGES – ADDED **SYSTEM BENEFITS**

Rittal standards deliver more overarching system advantages that are anything but standard.

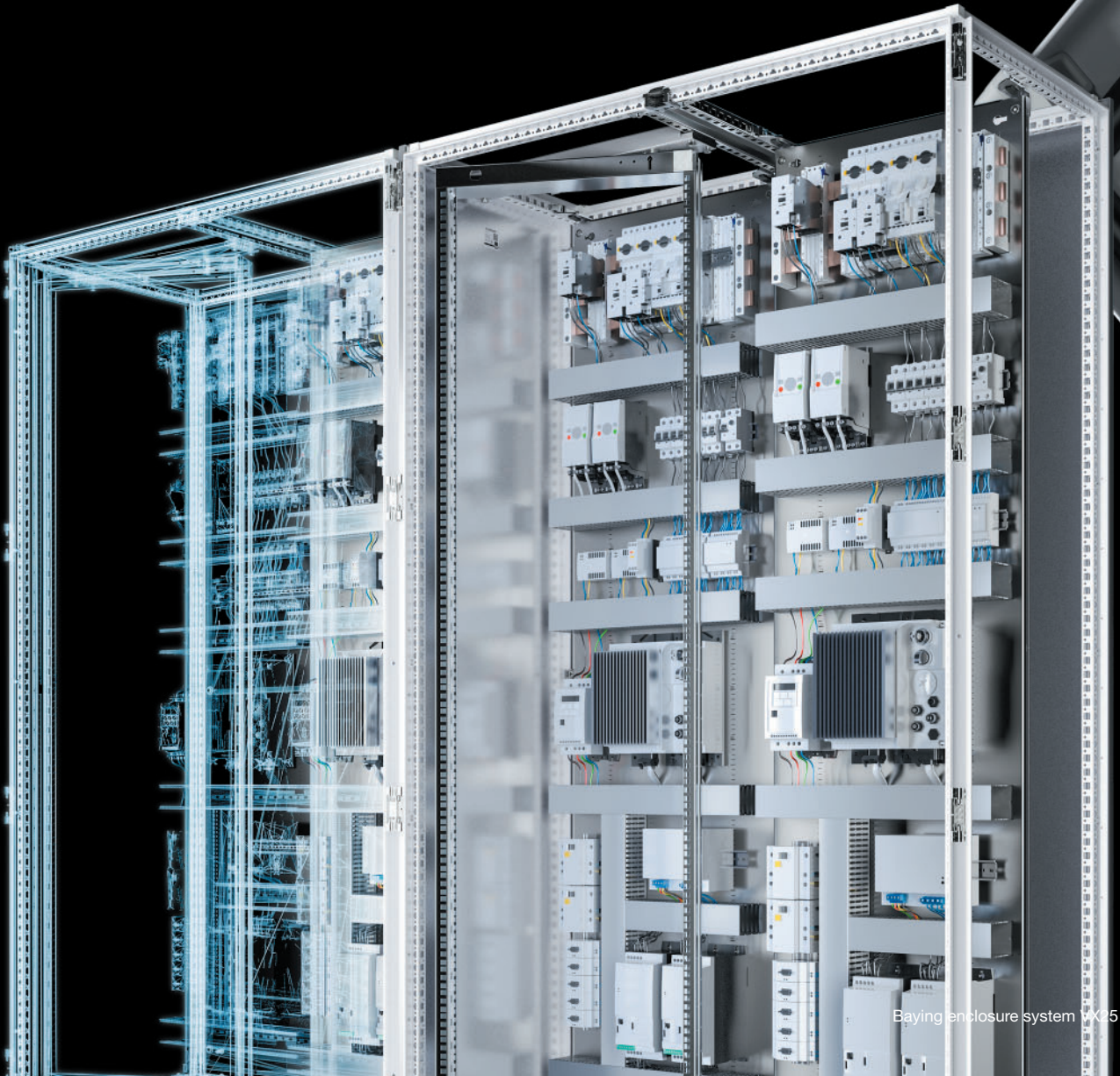



Digitisation

The QR code on all machinable enclosure panels permits fully automated incorporation into the production workflow, for seamless digital monitoring from the incoming goods right through to the finished product.



Time savings

Precise hole counting offers an easy point of orientation at all levels of the enclosure frame when fixing rails and punched sections in place.

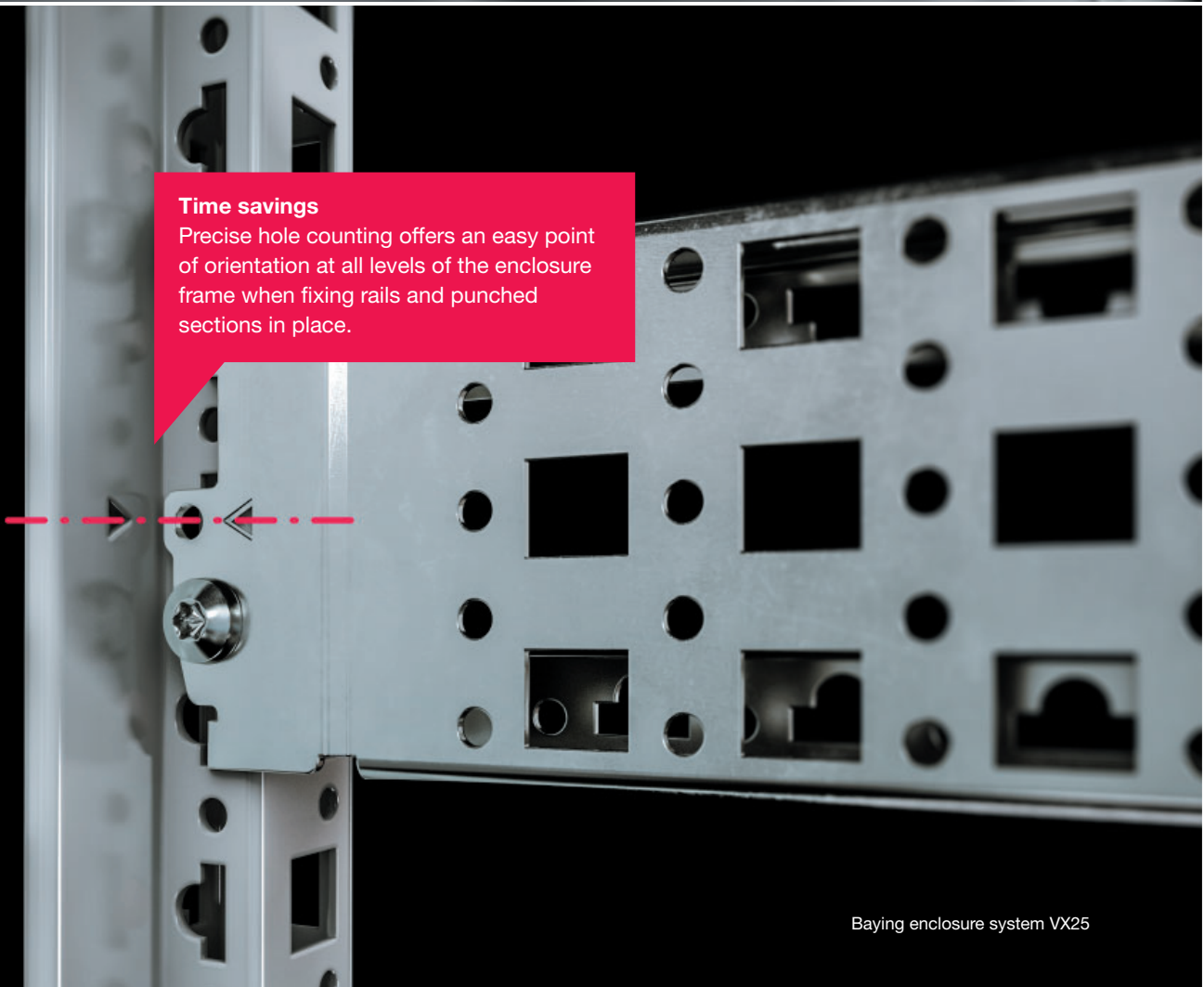



Labour-saving

For one-man assembly, the positioning aid for the side and rear panels allows labour-saving pre-fixing for the ideal fit, which you can screw-fasten later on when you have both hands free.



Material savings

As standard, potential equalisation of the enclosure panels occurs during screw-fastening, which saves up to seven earth straps per enclosure and also improves work safety by eliminating sharp-edged protruding parts.



Corrosion protection

The three-stage surface treatment process guarantees maximum protection against corrosion and is resistant to mineral oils, lubricants, machining emulsions and most solvents.

- 1 Nanoceramic treatment
- 2 Electrophoretic dipcoat priming
- 3 Powder coating



Safety
The seamless, foamed-in PU seal offers long-term elasticity and can be painted over as required without posing any problems.



System
Automatic potential equalisation of the roof, rear panel and sides acts as earthing when Rittal climate control devices and Rittal fan-and-filter units are installed.



Health and safety at work

Rounded edges ensure optimum work safety standards when populating the enclosure.

Stability

The seamlessly laser-welded, roll-formed enclosure profile ensures optimum force transmission on installed equipment.



Reliable engineering

Rittal's customers are supported by a wealth of conversion and planning tools in the automated production process and when working with a virtual prototype.

- Configurators
- Parts list converter
- EPLAN Pro Panel
- 2D/3D CAD data
- ecl@ss Advanced
- Technical documentation
- Planning data
- Assembly videos



FRAME AND PUNCHED SECTION – ADDED SYSTEM **BENEFITS**

Now with added assembly-friendliness plus efficient engineering thanks to a symmetrical frame section on a 25 mm pitch pattern across all levels, accessible from all sides.

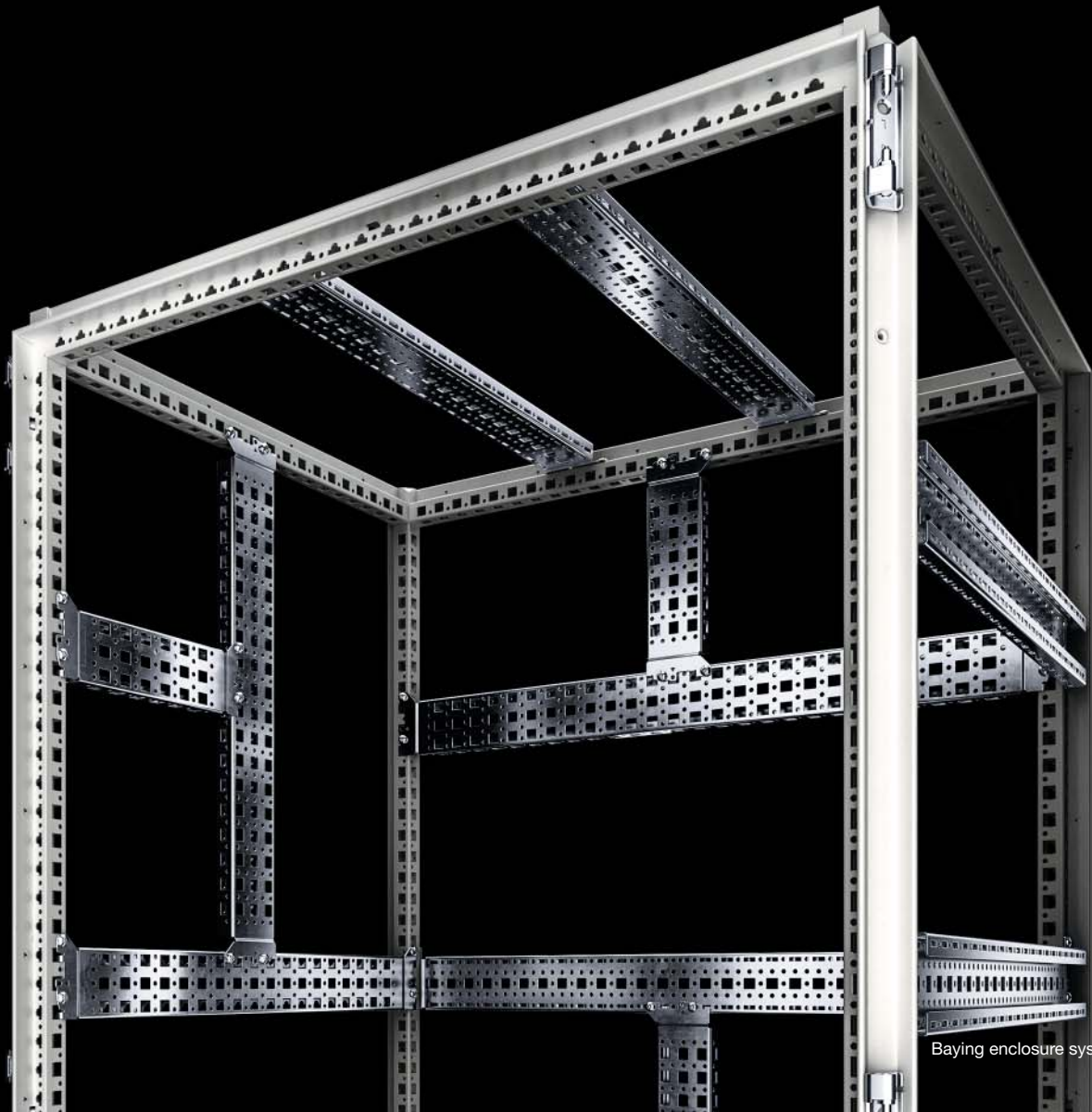

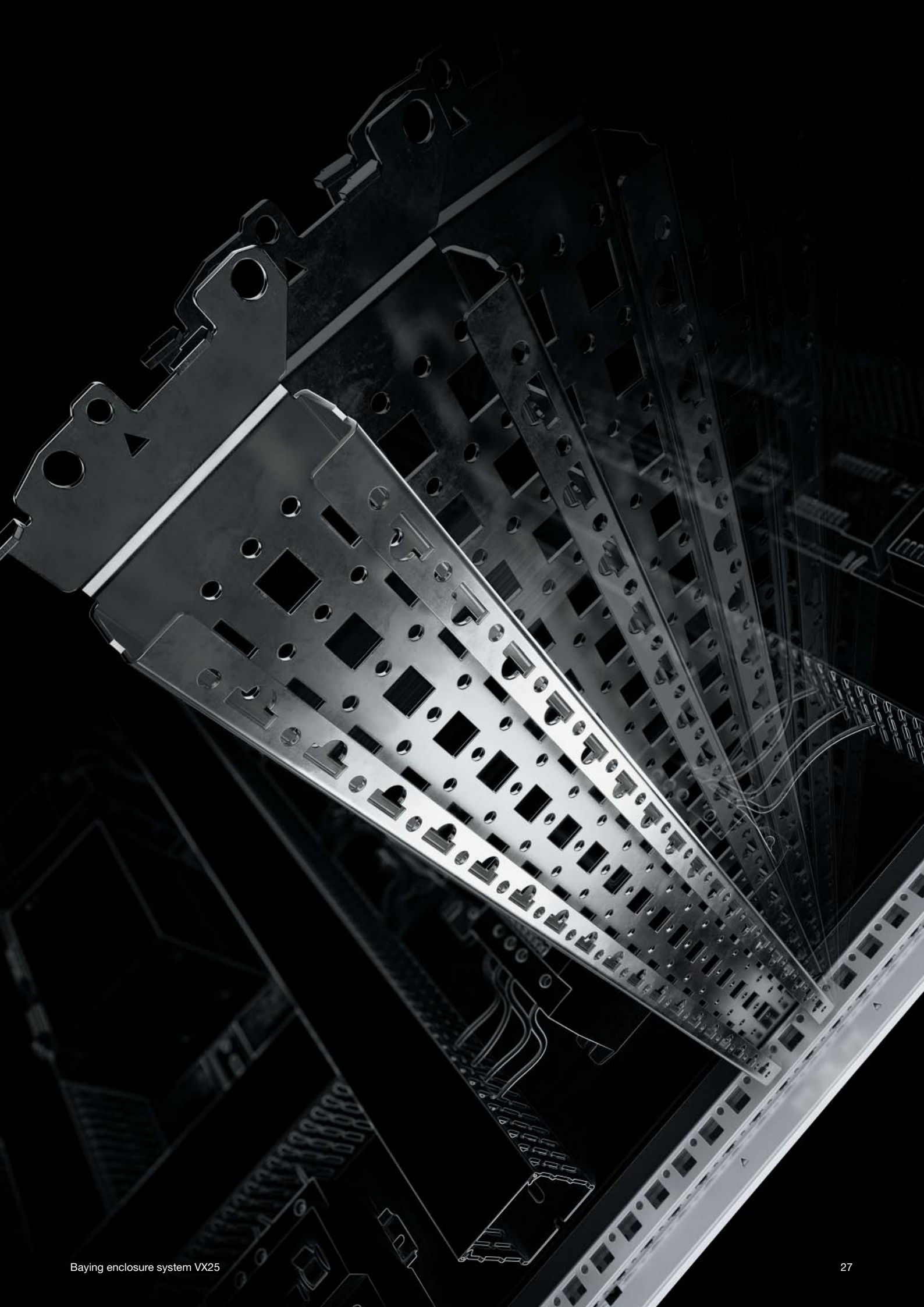



Accessibility

The system offers an outer mounting level in addition to the inner level, making the enclosure readily accessible and configurable from the outside.

A: Static Structural
Equivalent Stress
Type: Equivalent (von-Mises) Stress
Unit: MPa
Time: 1
07.03.2018 14:25

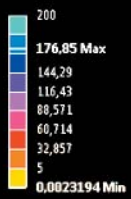

Stability

Thanks to its ingenious geometry, the patented special profile ensures excellent stability and torsional rigidity.

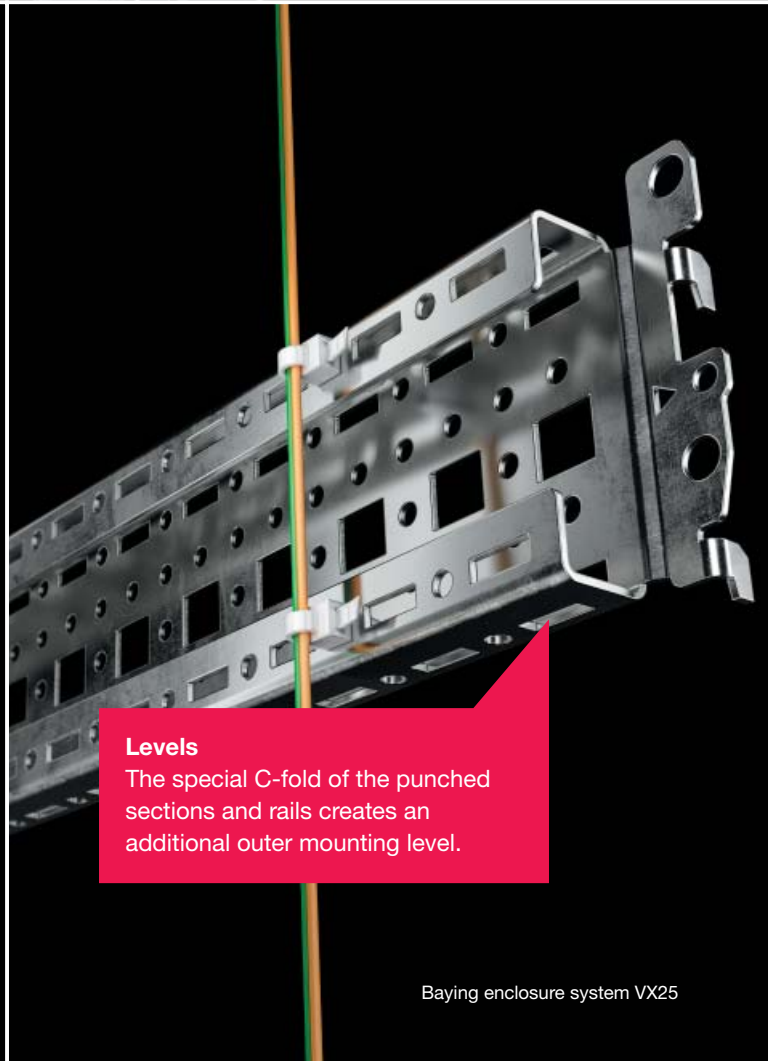

Levels

The special C-fold of the punched sections and rails creates an additional outer mounting level.

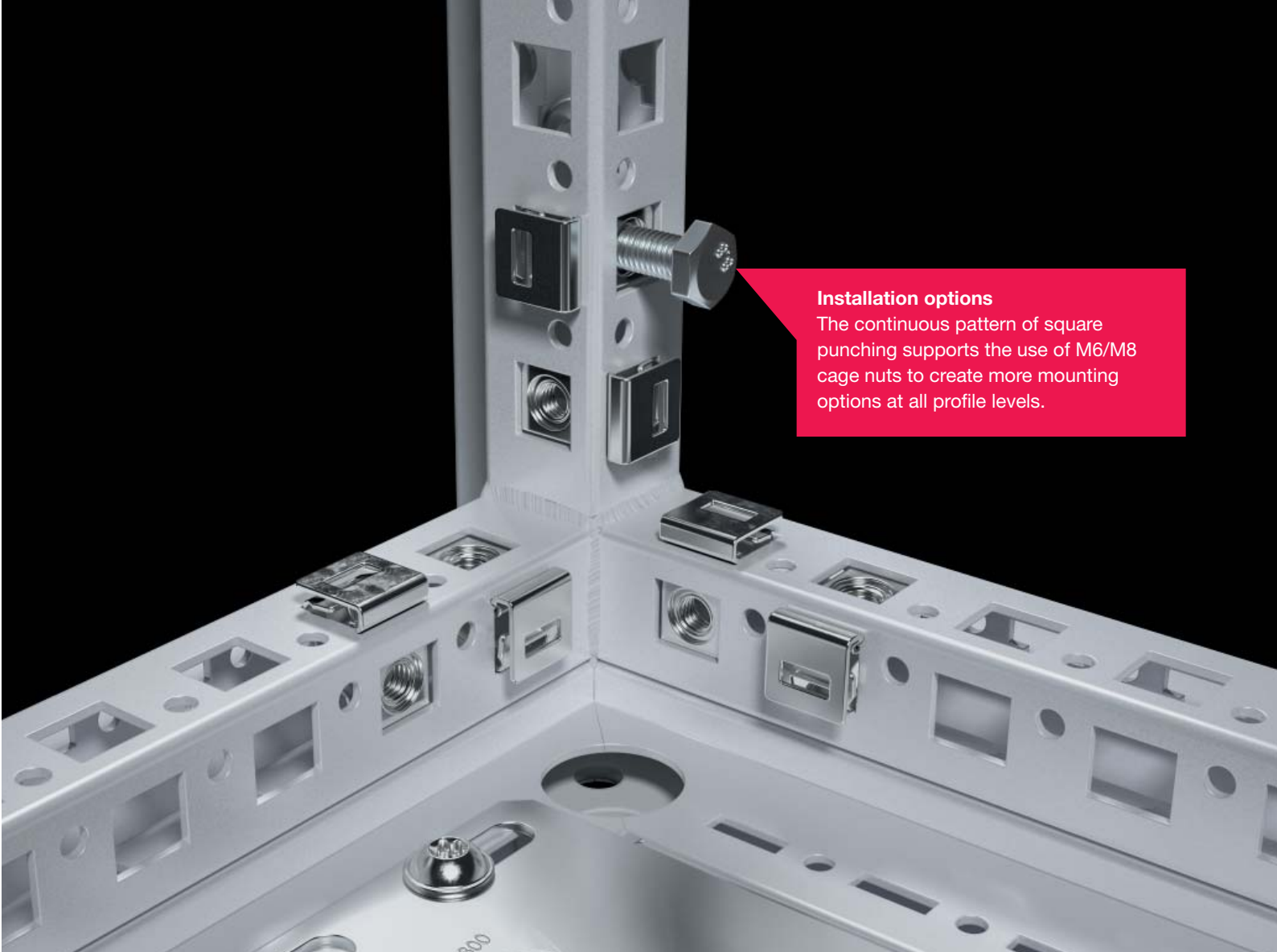

Installation options

The continuous pattern of square punching supports the use of M6/M8 cage nuts to create more mounting options at all profile levels.

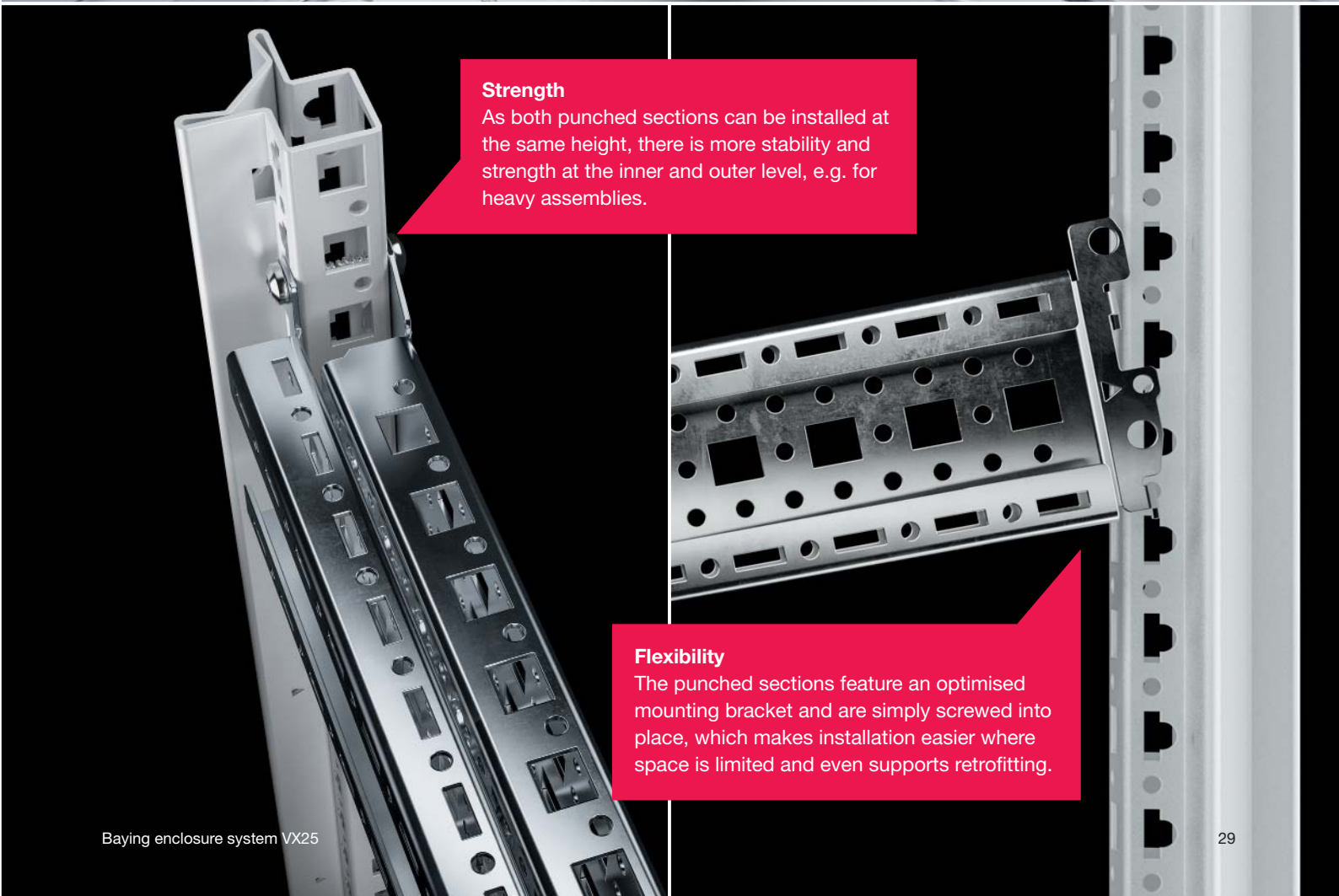

Strength

As both punched sections can be installed at the same height, there is more stability and strength at the inner and outer level, e.g. for heavy assemblies.

Flexibility

The punched sections feature an optimised mounting bracket and are simply screwed into place, which makes installation easier where space is limited and even supports retrofitting.



Ease of assembly

The frame profile allows users to install elements working through the profile from the outside, making it much easier to retrofit punched sections in places that can no longer be reached from the inside.

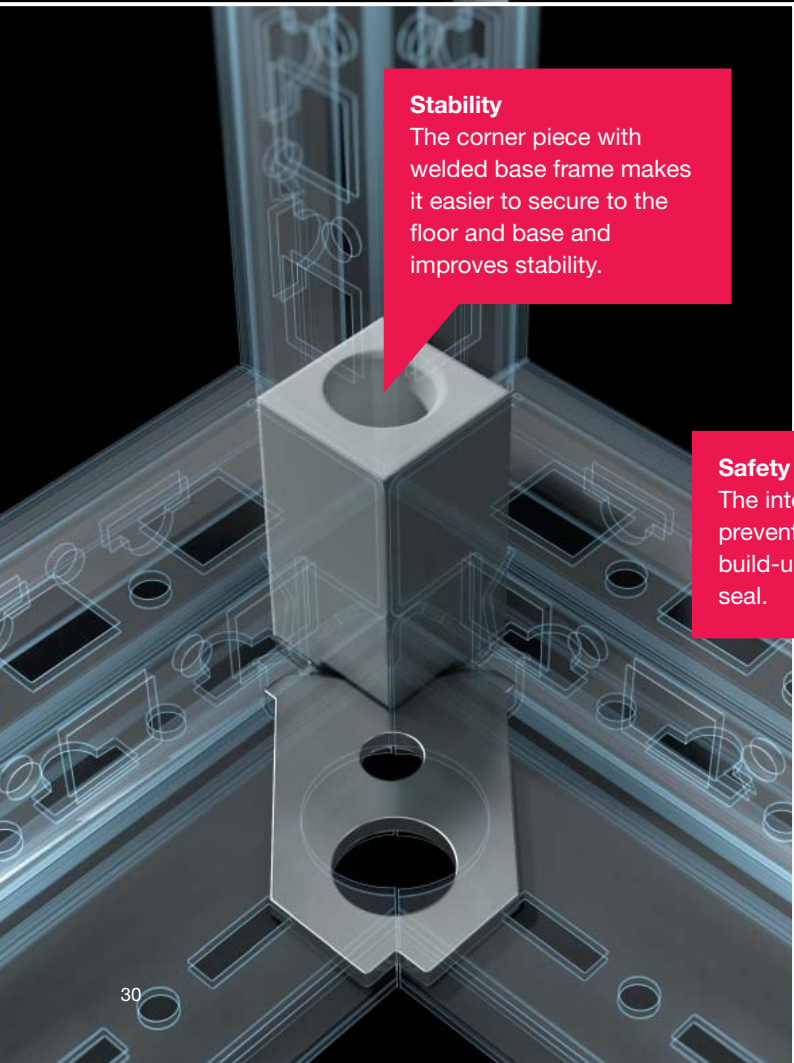

Stability

The corner piece with welded base frame makes it easier to secure to the floor and base and improves stability.



Safety

The integral rain channel prevents the long-term build-up of moisture at the seal.



Mounting options

Using the standard punched section, including to support the roof and side panels, simplifies engineering and assembly, and relieves pressure on the parts warehouse.



Cost-efficiency

The frame profile, which is identical horizontally and vertically, enables consistent use of standardised punched sections and rails, which reduces the number of part variants by up to 40 per cent without losing any functionality.

Mounting plates

The system divider designed for installation in the enclosure depth divides wide enclosures into two halves, increasing the flexibility of interior installation.



DOORS AND WALLS – ADDED **TIME SAVINGS**

More flexible, assembly-friendly and economical, thanks to an ingenious hinge system, a quick-fit and readily replaceable lock system, and the elimination of avoidable machining processes.





Labour-saving

The new hinge allows doors to be fitted and removed incredibly easily without any tools, and separately locking and unlocking the hinge bolts is a thing of the past.

Time savings

There is no need to machine the door when installing the 180° hinge, which reduces the installation time during retrofitting by up to 30 minutes per door.



Time savings

The simple, tool-free exchangeability of lock systems, such as the comfort handle reduces the necessary installation time by up to 50 per cent.



Labour-saving

For one-man assembly, the positioning aid for the side and rear panels allows labour-saving pre-fixing for the ideal fit, which you can screw-fasten later on when you have both hands free.



Safety

The adjacent door latch mechanism is operated from outside for extra convenience and safety because users don't have to reach inside the enclosure.

Easy assembly

The innovative clip mechanism of the panel holders speeds up the installation of side panels.

Access

The panel holders can also be easily retrofitted and are clipped into place from the outside without having to first remove previously installed rear panels.

Expansion options

Thanks to its ingenious geometry, the special profile ensures excellent stability, torsional rigidity and flexibility for door installations.

Processability

The QR code on all machinable enclosure panels permits fully automated incorporation into the production workflow, for seamless digital monitoring from the incoming goods right through to the finished product.





Flexibility

The opportunity to change the opening direction of main and adjacent doors on double-door enclosures according to needs, creates added flexibility when installing cooling units in enclosure doors and prevents collisions between equipment and doors.



Accelerator

The series-standard T-head punching in the tubular door frame speeds up the process of laying cables in the door. Cables can be fixed to the door extremely quickly, even when using conventional commercial cable ties.

Usable height

The flat centre seal does not obstruct the movement of the swing frame or other components.





BASE AND FLOOR – **ADDED** SPACE

Make better use of space, simplify work and save time thanks to the outstanding compatibility of the enclosure and base – even when buying enclosures and fitting accessories.

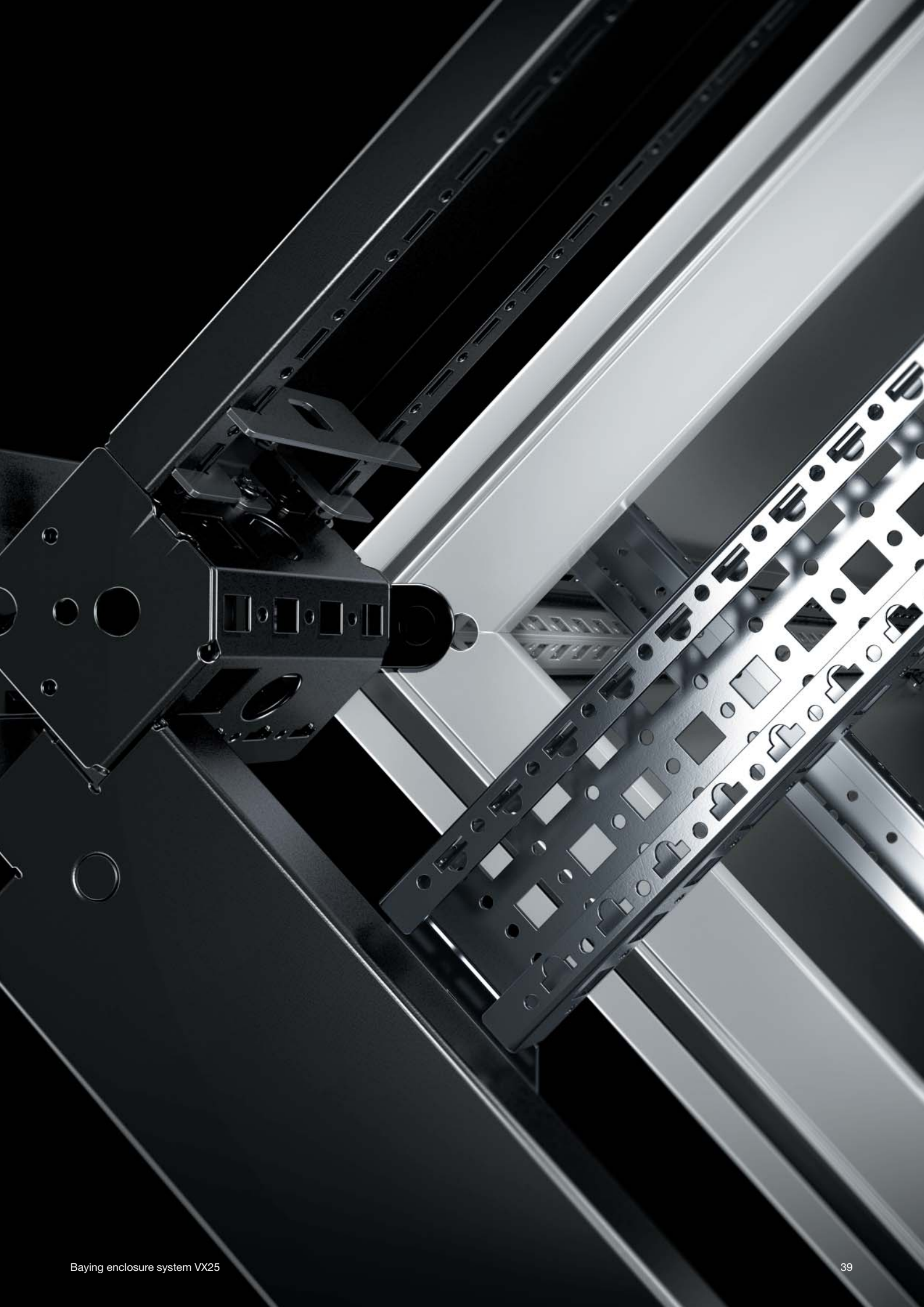

Variability

The enclosure is secured to the base/plinth or subsurface either via the M12 thread in the corner piece or via the stable base structure.

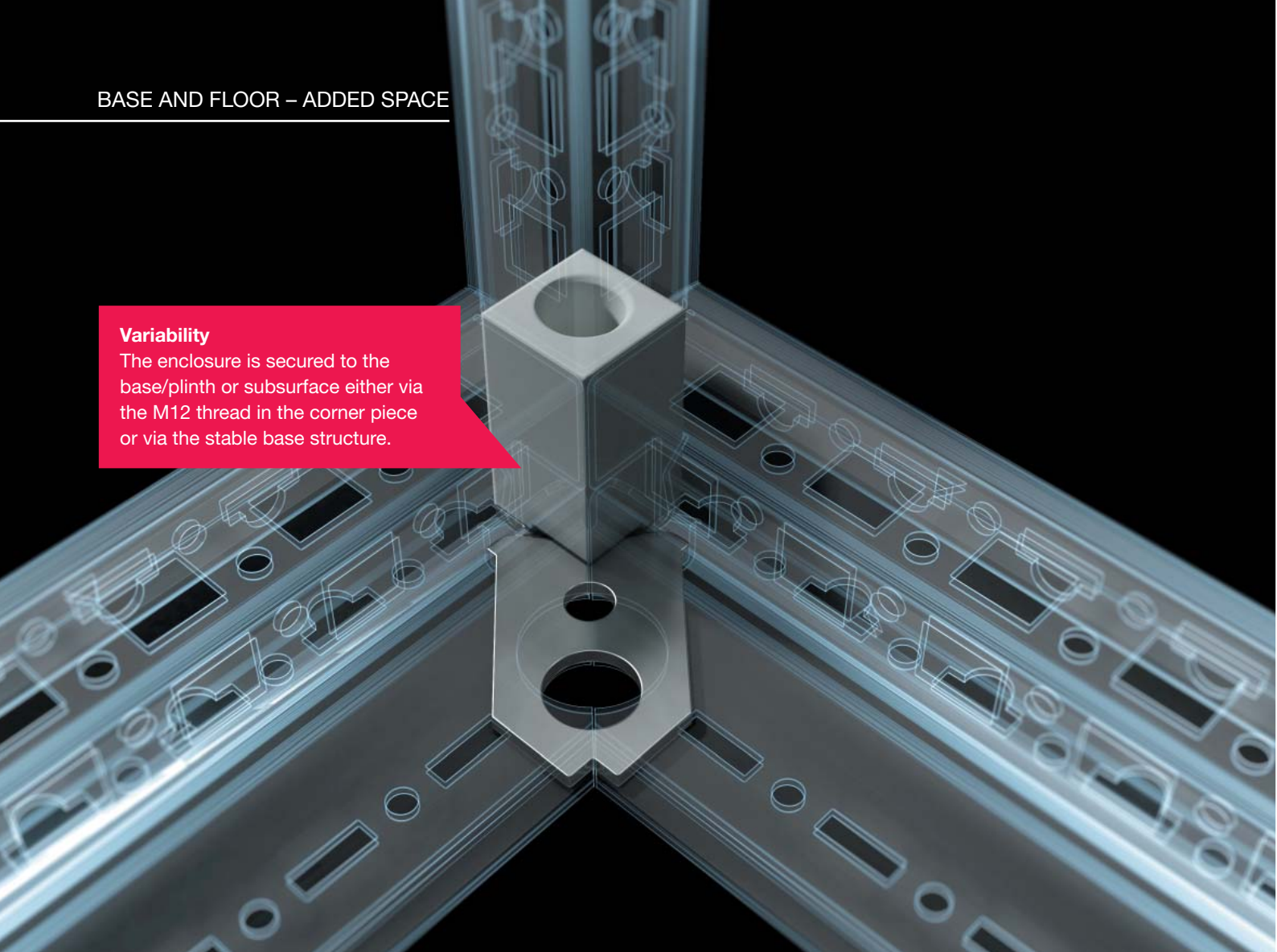

Ease of use

A direct screw connection between the base/plinth components and the enclosure automatically creates potential equalisation without having to incorporate any earth straps.



Precision

The centring aid for base/plinth mounting on the enclosure frame ensures the enclosure is positioned precisely on the base/plinth and also safeguards the IP protection category and frame protection when used without a base/plinth.

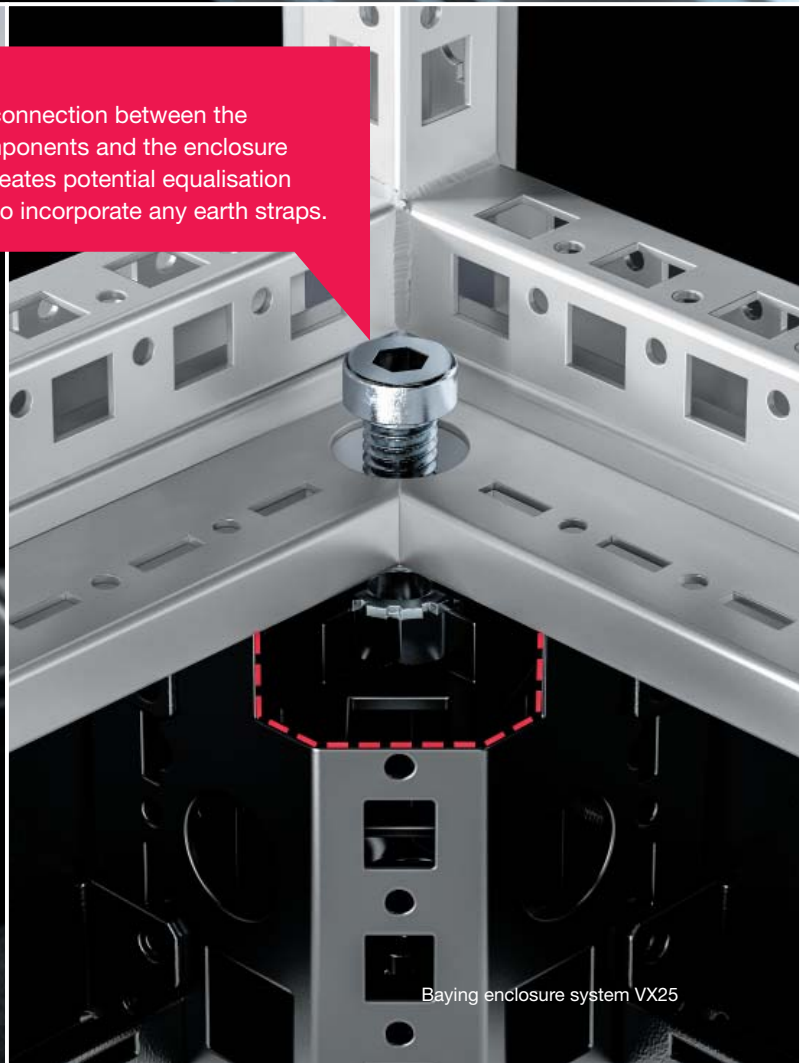



Time savings

Simple screw fastening of the gland plates is fast, and automatically creates potential equalisation in a single step.

Transparency

The identifying dimensions stamped into the gland plates make it easier to allocate gland plates the matching enclosure.

Space for cables

The large opening in the stable base frame makes it much easier to install cables.



Labour-saving

The earthing points with standardised markings provide helpful assists, enabling quicker work flow.

Cable-friendly

Rounded edges prevent cables routed under the enclosure from being damaged.

Rigidity

The double edge fold on the gland plates prevents bending even under heavy loads and guarantees the required high degree of protection.



BAYING – ADDED **SIMPLIFICATION**

Complexity is further reduced thanks to a simplified, more consistent baying system for all applications.



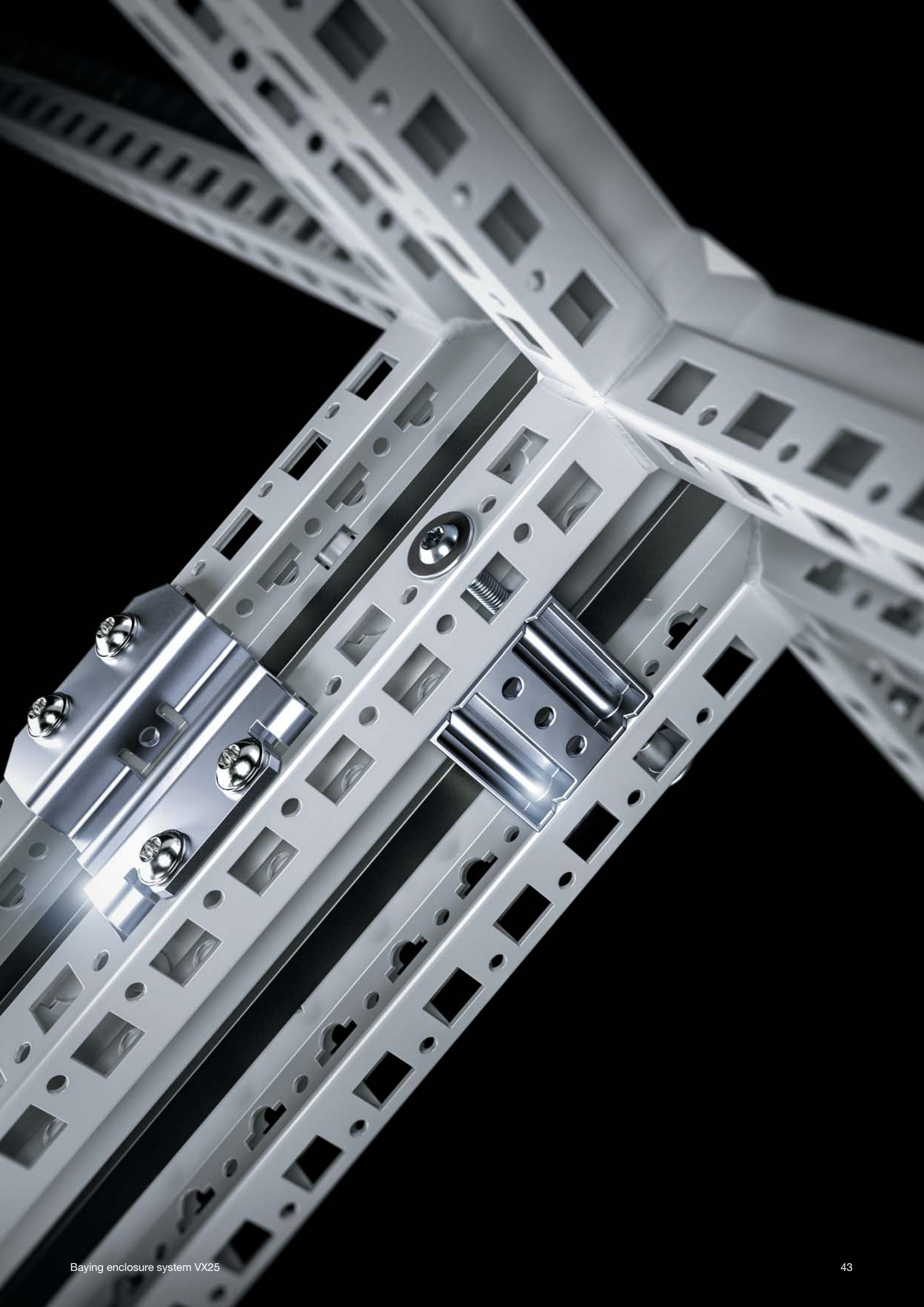

Overview

The baying connectors are designed so that all the baying scenarios that crop up in enclosure engineering can be covered with a maximum of just three different baying solutions. That means it is easier to make decisions and takes some of the hard work out of engineering.

Location flexibility

The option of baying from all four sides allows an individual response to every space situation.



Sealing efficiency

The seal, which can be inserted in a flash, allows precise positioning and can be removed at any time.

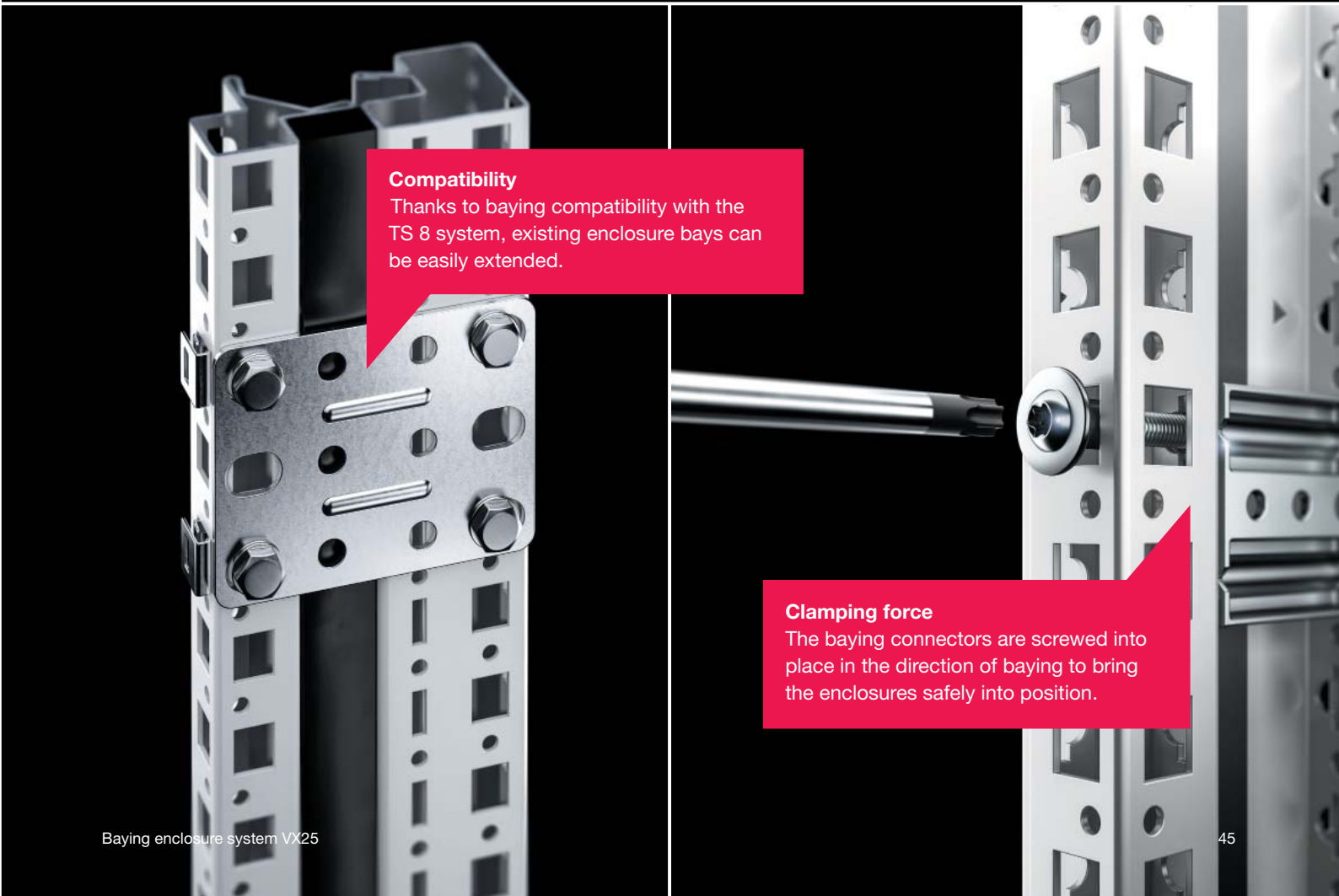

Compatibility

Thanks to baying compatibility with the TS 8 system, existing enclosure bays can be easily extended.

Clamping force

The baying connectors are screwed into place in the direction of baying to bring the enclosures safely into position.



MOUNTING PLATE – ADDED **ASSEMBLY-FRIENDLINESS**

More time gains, installation options and assembly-friendliness thanks to improved installation kits – also suitable for dynamic loads.





Additional benefits

The practical mounting plate slide rail can be removed once the mounting plate has been inserted and used elsewhere in the enclosure as a fully functional punched section.

Digitisation

The QR code on all machinable enclosure panels permits fully automated incorporation into the production workflow, for seamless digital monitoring from the incoming goods right through to the finished product.

Process efficiency

The integral clip means that the mounting plate slide block can be dismantled with no need for tools and easily refitted. This helps to streamline the fully automated machining process in every respect.





Space gain

The option of fitting the mounting plate 20 mm deeper in the enclosure with a special installation kit creates additional space in the enclosure depth.

Ease of placement

The printed scale ensures components can be easily and quickly positioned on the mounting plate – without having to carry out separate measurements.



Flexibility

Thanks to the potential for depth adjustment in the 25 mm pitch pattern, the mounting plate can be installed at the optimum position for the application.



Convenient fixing

The clip at the top of the mounting plate holds it in place during one-person assembly until the plate can be screwed into position.

FIND WHAT YOU NEED EASILY – WITH BONUS INFORMATION

Product overview

Here you will find all the dimensions and designs at a glance.

Page 52/53



Height x depth mm	Width mm	Doors	Basic enclosure		Basic enclosure with glazed door ¹⁾	Electronic enclosure ²⁾	IP66/NEMA 4
			Model No.	Model No.	Model No.	Model No.	Model No.
1200 x 500	600	1	Sheet steel	Stainless steel	Sheet steel	Sheet steel	Sheet steel
	800	1	8615.000	–	–	–	–
	1200	2	8215.000	–	–	–	–
1400 x 500	600	1	8645.000	–	–	–	–
	800	1	8645.000	–	–	–	–
	1200	2	8245.000	–	–	–	–
1600 x 500	600	1	8665.000	–	–	–	–
	800	1	8665.000	–	–	–	–
	1200	2	8265.000	–	–	–	–
1600 x 600	600	1	–	–	–	8410.000	–
	800	1	–	–	–	8418.000	–
1800 x 400	600	1	8684.000	8454.000	–	–	–
	800	1	8684.000	8454.000	–	–	–
	1000	1	8084.000	–	–	–	–
	1000	2	8080.000	–	–	–	–

Benefits

The VX25 is packed full of interesting innovations. Read here if you would like to understand how they benefit you.

Page 19 – 49



Ordering information for the buying enclosure system VX25

Once you have chosen a suitable enclosure, in the column below you will find the Model Numbers for those all-important matching accessories. Details of these accessory components are easily referenced using the page numbers in the right-hand column.

Page 54 – 76

System accessories Page 82 **482.6 mm (19") installation accessories** Page 206

Material and surface finish:
– Enclosure frame: Sheet steel, 1.5 mm, zinc-plated
– Roof: Sheet steel, 1.5 mm, dipcoat-primed, powder-coated on the outside, textured paint
– Front frame: Extruded aluminium section, powder-coated
– Rear door: Sheet steel, 2 mm, dipcoat-primed, powder-coated on the outside, textured paint

– Gland plates: Sheet steel, 1.5 mm, zinc-plated
– 482.6 mm (19") adaptor sections: Sheet steel, zinc-plated

Colour:
– RAL 7035

Supply includes:
– Enclosure frame
– Front frame (r/h hinge, held on the left via mechanical snap fasteners)
– Rear door (r/h hinge, may be swapped to opposite side)
– Roof plate
– Gland plates
– Adaptor sections, 482.6 mm (19"), front

Approvals:
– Bureau Veritas

Electronic enclosure

Height units U	Packs of	33	33	42	42	Page
Width mm		600	600	600	600	
Height mm		1600	1600	2000	2000	
Depth mm		600	800	600	800	
Model No.	1 pcs(s)	8410.000	8418.000	8430.000	8438.000	
Weight, approx. kg		58.0	53.2	57.8	72.2	

Accessories

Accessories	2 pcs(s)	8640.002	8640.002	8640.002	8640.002	89
Base/plinth corner pieces with base/plinth trim panels, front and rear, 100 mm	2 pcs(s)	8640.033	8640.034	8640.033	8640.034	90
Base/plinth corner pieces with base/plinth trim panels, front and rear, 200 mm	2 pcs(s)	8640.022	8640.022	8640.022	8640.022	89
Base/plinth trim panels, side, 100 mm	2 pcs(s)	8640.043	8640.044	8640.043	8640.044	90
Base/plinth trim panels, side, 200 mm	4 pcs(s)	4612.000	4612.000	4612.000	4612.000	96
Leveling feet	2 pcs(s)	8166.245	8166.245	8108.245	8108.245	102
Side panels, screw-fastened, sheet steel	1 pcs(s)	8618.200	8618.200	8618.200	8618.200	128
Comfort handle VX for lock inserts	1 pcs(s)	8618.230	8618.230	8618.230	8618.230	128

Knowledge is about knowing where to find the right information. It may sound banal, but there is a serious message here. This brochure contains a wealth of information for all relevant target groups within your company, and it is well worth looking at this page. You will find valuable information to help you find the right solution quickly and easily.



Important information on the use of accessories
 To enable you to fully appreciate the benefits of our accessory range, each chapter highlights the principal applications. Allow us to inspire you, and explore the vast range of opportunities.
 From page 82

Enclosure frame
 The patented profile is completely symmetrical across all levels and equipped with 25 mm system punchings that are consistently retained even across multiple enclosures.

Two mounting levels
 The two mounting levels, spaced 25 mm apart, allow optimum flexibility and maximise the space available for interior installation.

1 Outer mounting level
 2 Inner mounting level

Punched section with mounting flange for the inner mounting level
 The punched section with mounting flange supports system configuration on a 25 mm pitch pattern across all levels of the VX25, even beyond enclosure boundaries. With the system punchings, cage nuts up to M8 can be used across three levels. This allows you to securely fasten your own components with metric screws. Direct mounting on the horizontal enclosure section is also supported.

Punched section with mounting flange for the outer mounting level
 The punched section is easily retro-fitted, even with the side panel already installed, because the rounded edges allow it to be screwed in. The additional C-fold may be used to support heavy installed equipment on the side panel or roof, or for attaching...

Ordering information for accessories
 All accessory components are described and presented in depth. The detailed information on each product ensures that nothing is forgotten, and any special features can be incorporated into your planning.
 From page 82

Interior installation

Rail systems

Punched section with mounting flange, 23 x 89 mm
 For versatile, individual interior installation of the enclosure frame on the inner mounting level. Simply locate into punchings and screw-fasten. System punchings on all four sides. With slots at the top and bottom for cage nuts, for attaching your own components via metric screws. Especially for cable routing in the base/plinth system VX, stainless steel and for the installation of busbar supports (non-magnetic stainless steel).

For enclosure width/depth mm	P. of	Model No.
400	2 pcs(s)	8100.730
500	2 pcs(s)	8100.731
600	2 pcs(s)	8100.732
800	2 pcs(s)	8100.733

Accessories:
 - Screws, see page 158
 - Cable ties 2597.000, see page 188
 - Cage nuts, see page 157
 - Base/plinth installation bracket, see page 89

Installation options:
 ■ On the inner mounting level, on the enclosure section
 ■ On identical punched sections with mounting flanges
 ■ Base/plinth system VX, stainless steel, in the width and depth, combined with a base/plinth installation bracket

Material:
 - Stainless steel

Supply includes:
 - Assembly parts

Technical details
 All the main dimensions of the VX25 are shown here in a compact, clear format, without electronic aids. Should you require more detailed information, this can be found at www.rittal.com
 Page 215 – 228

Note:
 - With fitted side panels, the overall width (B1) is increased by 13 mm.
 - Between bayed enclosures, allow 1 mm for the seal.

Baying enclosure system VX25 – Product overview



			Basic enclosure		Basic enclosure with glazed door ¹⁾	Electronic enclosure ²⁾	IP66/NEMA 4	
Height x depth mm	Width mm	Doors	Model No.	Model No.	Model No.	Model No.	Model No.	
Material			Sheet steel	Stainless steel	Sheet steel	Sheet steel	Sheet steel	
1200 x 500	600	1	8615.000	-	-	-	-	
	800	1	8815.000	-	-	-	-	
	1200	2	8215.000	-	-	-	-	
1400 x 500	600	1	8645.000	-	-	-	-	
	800	1	8845.000	-	-	-	-	
	1200	2	8245.000	-	-	-	-	
1600 x 500	600	1	8665.000	-	-	-	-	
	800	1	8865.000	-	-	-	-	
	1200	2	8265.000	-	-	-	-	
1600 x 600	600	1	-	-	-	8410.000	-	
1600 x 800	600	1	-	-	-	8418.000	-	
1800 x 400	600	1	8684.000	-	-	-	-	
	800	1	8884.000	8454.000	-	-	-	
	1000	1	8084.000	-	-	-	-	
	1000	2	8080.000	-	-	-	-	
	1200	2	8284.000	8456.000	-	-	-	
1800 x 500	400	1	8485.000	-	-	-	-	
	600	1	8685.000	8457.000	-	-	-	
	800	1	8885.000	8455.000	-	-	-	
	800	2	8880.000	-	-	-	-	
	1200	2	8285.000	8453.000	-	-	-	
1800 x 600	400	1	8486.000	-	-	-	-	
	600	1	8686.000	-	-	-	-	
	800	1	8886.000	-	-	-	-	
	800	2	8881.000	-	-	-	-	
	1200	2	8286.000	-	-	-	-	
2000 x 400	400	1	-	-	-	-	-	
	600	1	8604.000	-	-	-	-	
	800	1	8804.000	-	-	-	-	
	850	1	-	-	-	-	-	
	1000	2	8004.000	-	-	-	-	
	1100	2	-	-	-	-	-	
2000 x 500	400	1	8405.000	-	-	-	-	
	600	1	8605.000	-	-	-	-	
	800	1	8805.000	-	-	-	-	
	1000	2	8005.000	-	-	-	-	
	1200	2	8205.000	-	-	-	-	
2000 x 600	400	1	8406.000	-	-	-	-	
	600	1	8606.000	8452.000	8840.120	8430.000	-	
	800	1	8806.000	8450.000	8840.100	-	8807.000	
	850	1	-	-	-	-	-	
	1000	2	8006.000	-	-	-	-	
	1100	2	-	-	-	-	-	
	1200	2	8206.000	8451.000	-	-	-	
2000 x 800	400	1	-	-	-	-	-	
	600	1	8608.000	-	8840.130	8438.000	-	
	800	1	8808.000	-	8840.110	-	-	
	1200	2	8208.000	-	-	-	-	
2200 x 600	400	1	-	-	-	-	-	
	600	1	8626.000	-	-	-	-	
	800	1	8826.000	-	-	-	-	
	1000	1	-	-	-	-	-	
	1200	2	8226.000	-	-	-	-	
2200 x 800	400	1	-	-	-	-	-	
	600	1	-	-	-	-	-	
	800	1	-	-	-	-	-	
	1200	1	-	-	-	-	-	
from page			54	75	67	68	69	

¹⁾ Glazed door at the front, rear door ²⁾ Rear door

Baying enclosure system VX25 – Product overview



			IP66/NEMA 4X	Distribution enclosure	Modular enclosure ³⁾	Fuse-switch-disconnector enclosure	EMC enclosure	
	Width mm	Doors	Model No.	Model No.	Model No.	Model No.	Model No.	Model No.
			Stainless steel	Sheet steel	Sheet steel	Sheet steel	Sheet steel ⁴⁾	
	600	1	-	-	-	-	-	-
	800	1	-	-	-	-	-	-
	1200	2	-	-	-	-	-	-
	600	1	-	-	-	-	-	-
	800	1	-	-	-	-	-	-
	1200	2	-	-	-	-	-	-
	600	1	-	-	-	-	-	-
	800	1	-	-	-	-	-	-
	1200	2	-	-	-	-	-	-
	600	1	-	-	-	-	-	-
	600	1	-	-	-	-	-	-
	600	1	-	-	-	-	-	-
	800	1	-	-	-	-	-	-
	1000	1	-	-	-	-	-	-
	1000	2	-	-	-	-	-	-
	1200	2	-	-	-	-	-	-
	400	1	-	-	-	-	-	-
	600	1	-	-	-	-	-	-
	800	1	-	-	-	-	-	-
	800	2	-	-	-	-	-	-
	1200	2	-	-	-	-	-	-
	400	1	-	-	-	-	-	-
	600	1	-	-	-	-	-	-
	800	1	-	-	-	-	-	-
	800	2	-	-	-	-	-	-
	1200	2	-	-	-	-	-	-
	400	1	-	-	-	-	-	-
	600	1	-	-	-	-	-	-
	800	1	-	-	-	-	-	-
	800	2	-	-	-	-	-	-
	1200	2	-	-	-	-	-	-
	400	1	-	-	-	-	-	-
	600	1	-	-	-	-	-	-
	800	1	-	-	-	-	-	-
	800	2	-	-	-	-	-	-
	1200	2	-	-	-	-	-	-
	400	1	-	-	-	-	-	-
	600	1	-	-	-	-	-	-
	800	1	-	-	-	-	-	-
	850	1	-	9666.956	-	-	-	-
	1000	2	-	-	-	-	-	-
	1100	2	-	9666.966	-	-	-	-
	1200	2	-	-	-	-	-	-
	400	1	-	-	-	-	-	-
	600	1	-	-	-	-	-	-
	800	1	-	-	-	-	-	-
	1000	2	-	-	-	-	-	-
	1200	2	-	-	-	-	-	-
	400	1	-	-	9680.406	-	-	-
	600	1	-	-	9680.606	-	-	-
	800	1	8458.000	-	9680.806	-	-	8807.010
	850	1	-	9666.916	-	-	-	-
	1000	1	-	-	-	9680.005	-	-
	1100	2	-	9666.926	-	-	-	-
	1200	2	-	-	-	-	-	-
	400	1	-	-	9680.408	-	-	-
	600	1	-	-	9680.608	-	-	-
	800	1	-	-	9680.808	-	-	8807.020
	1200	1	-	-	-	9680.207	-	-
	400	1	-	-	9680.426	-	-	-
	600	1	-	-	9680.626	-	-	-
	800	1	-	-	9680.826	-	-	-
	1000	1	-	-	-	9680.025	-	-
	1200	2	-	-	-	-	-	-
	400	1	-	-	9680.428	-	-	-
	600	1	-	-	9680.628	-	-	-
	800	1	-	-	9680.828	-	-	-
	1200	1	-	-	-	9680.227	-	-
			79	70	71	73	74	

³⁾ Without door ⁴⁾ Sheet steel with magnesium zinc coating

Baying enclosure system VX25



System accessories Page 82 VX25 basic enclosure with glazed door Page 66 VX25, stainless steel Page 75 VX25 EMC-shielded Page 74

Material and surface finish:

- Enclosure frame: Sheet steel, 1.5 mm, dipcoat-primed
- Roof: Sheet steel, 1.5 mm, dipcoat-primed, powder-coated on the outside, textured paint
- Door: Sheet steel, 2 mm, dipcoat-primed, powder-coated on the outside, textured paint
- Rear panel: Sheet steel, 1.5 mm, dipcoat-primed, powder-coated on the outside, textured paint
- Gland plates: Sheet steel, 1.5 mm, zinc-plated
- Mounting plate: Sheet steel, 3 mm, zinc-plated

Supply includes:

- Enclosure frame
- Door(s) (r/h hinge, may be swapped to opposite side)
- Roof plate
- Rear panel
- Gland plates
- Mounting plate
- 2 punched rails 18 x 39 mm
- Lock: 3 mm double-bit

Approvals:

- UL
 - cUL
 - Bureau Veritas
 - DNV-GL
 - Lloyds Register of Shipping
- Further approvals can be found on the Internet.

Colour:

- RAL 7035

Protection category IP to IEC 60 529:

- IP55

Protection category NEMA:

- NEMA 1, 12

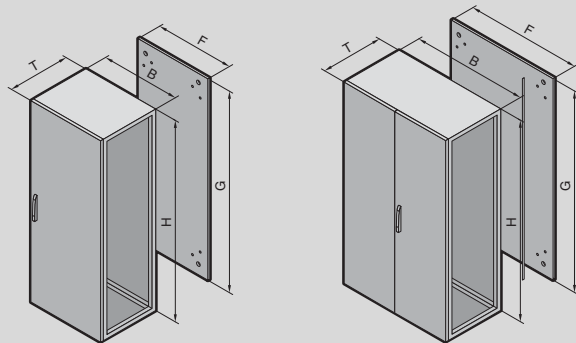

Baying enclosure system VX25

Basic enclosure, height 1200 mm, depth 500 mm

Width (B) mm	Packs of	600	800	1200	Page
Height (H) mm		1200	1200	1200	
Depth (T) mm		500	500	500	
Mounting plate width (F) mm		499	699	1099	
Mounting plate height (G) mm		1096	1096	1096	
Model No.	1 pc(s).	8615.000	8815.000	8215.000	
Weight, approx. kg		66.0	82.4	126.0	
Product-specific scope of supply					
Door(s)		1	1	2	
Accessories					
Base/plinth corner pieces with base/plinth trim panels, front and rear, 100 mm	2 pc(s).	8640.002	8640.003	8640.007	89
Base/plinth trim panels, sides, 100 mm	2 pc(s).	8640.032	8640.032	8640.032	90
Base/plinth corner pieces with base/plinth trim panels, front and rear, 200 mm	2 pc(s).	8640.022	8640.023	8640.025	89
Base/plinth trim panels, sides, 200 mm	2 pc(s).	8640.042	8640.042	8640.042	90
Levelling feet	4 pc(s).	4612.000	4612.000	4612.000	96
Side panels, screw-fastened, sheet steel	2 pc(s).	8115.245	8115.245	8115.245	102
Divider panel	1 pc(s).	–	–	–	
Divider panel for module plates	1 pc(s).	–	–	–	
Baying bracket, internal	6 pc(s).	8617.500	8617.500	8617.500	112
Baying block, internal	6 pc(s).	8617.501	8617.501	8617.501	112
Baying connector, external	6 pc(s).	8617.502	8617.502	8617.502	112
Glazed door	1 pc(s).	–	–	–	
Comfort handle VX for lock inserts	1 pc(s).	8618.200	8618.200	8618.200	128
Comfort handle VX for lock inserts and padlock	1 pc(s).	8618.230	8618.230	8618.230	128
Comfort handle VX for profile half-cylinders	1 pc(s).	8618.250	8618.250	8618.250	128
Comfort handle VX with security lock insert, lock E1	1 pc(s).	8618.240	8618.240	8618.240	128
Comfort handle VX for ASSA lock system	1 pc(s).	8618.270	8618.270	8618.270	128
Lock inserts		see page	see page	see page	129
180° hinges	4 pc(s).	8618.330	8618.330	8618.330	119
Punched section with mounting flange, 14 x 39 mm, for tubular door frame	4 pc(s).	8619.720	8619.730	8619.720	134
Wiring plan pocket, sheet steel, depth 35 mm	1 pc(s).	4116.500	4118.500	4116.500	135
Wiring plan pocket, sheet steel, depth 90 mm	1 pc(s).	4116.000	4118.000	4116.000	135
Door stay for escape routes	1 pc(s).	8618.400	8618.400	8618.400	136
Ride-up roller	10 pc(s).	8618.420	8618.420	8618.420	136
Mounting plate infill	1 pc(s).	–	–	–	
Punched section with mounting flange 18 x 64 mm for the outer level, in the width	4 pc(s).	8617.030	8617.040	8617.060	164
Punched section with mounting flange 18 x 64 mm for the outer level, in the depth	4 pc(s).	8617.020	8617.020	8617.020	164
Punched section with mounting flange 23 x 64 mm for the inner level, in the width	4 pc(s).	8617.130	8617.140	8617.160	164
Punched section with mounting flange 23 x 64 mm for the inner level, in the depth	4 pc(s).	8617.120	8617.120	8617.120	164
Punched rail 18 x 39 mm for the enclosure depth	4 pc(s).	8617.710	8617.710	8617.710	166
Support strip for the enclosure depth	20 pc(s).	4695.000	4695.000	4695.000	166
C rail 30/15, for the enclosure width	6 pc(s).	4944.000	4945.000	4947.000	167
Support rail 48 x 26 mm, for the enclosure width	2 pc(s).	8617.800	8617.810	8617.830	167
LED system light		see page	see page	see page	177
Earth straps		see page	see page	see page	186
Cable entry plates		8619.800	8619.801	8619.803	198
	Packs of	2 pc(s).	2 pc(s).	4 pc(s).	
Cable entry grommets	8 cables, max. Ø 13 mm	25 pc(s).	4316.000	4316.000	198
	3 cables, max. Ø 21 mm	25 pc(s).	4317.000	4317.000	198
	1 cable, max. Ø 47 mm	25 pc(s).	4318.000	4318.000	198
Connector grommets	10 pc(s).	4311.000	4311.000	4311.000	198
Section for cable entry, centre		8618.800	8618.801	8618.803	199
	Packs of	2 pc(s).	2 pc(s).	4 pc(s).	
Section for cable entry, rear		8618.810	8618.811	8618.813	199
	Packs of	2 pc(s).	2 pc(s).	4 pc(s).	
Cable duct		see page	see page	see page	203
Cable clamp rail, right angle section	2 pc(s).	8619.410	8619.420	8619.440	204

Baying enclosure system VX25

Basic enclosure, height 1400 mm, depth 500 mm

Width (B) mm	Packs of	600	800	1200	Page
Height (H) mm		1400	1400	1400	
Depth (T) mm		500	500	500	
Mounting plate width (F) mm		499	699	1099	
Mounting plate height (G) mm		1296	1296	1296	
Model No.	1 pc(s).	8645.000	8845.000	8245.000	
Weight, approx. kg		73.8	92.2	141.0	
Product-specific scope of supply					
Door(s)		1	1	2	
Accessories					
Base/plinth corner pieces with base/plinth trim panels, front and rear, 100 mm	2 pc(s).	8640.002	8640.003	8640.007	89
Base/plinth trim panels, sides, 100 mm	2 pc(s).	8640.032	8640.032	8640.032	90
Base/plinth corner pieces with base/plinth trim panels, front and rear, 200 mm	2 pc(s).	8640.022	8640.023	8640.025	89
Base/plinth trim panels, sides, 200 mm	2 pc(s).	8640.042	8640.042	8640.042	90
Levelling feet	4 pc(s).	4612.000	4612.000	4612.000	96
Side panels, screw-fastened, sheet steel	2 pc(s).	8145.245	8145.245	8145.245	102
Divider panel	1 pc(s).	–	–	–	
Divider panel for module plates	1 pc(s).	–	–	–	
Baying bracket, internal	6 pc(s).	8617.500	8617.500	8617.500	112
Baying block, internal	6 pc(s).	8617.501	8617.501	8617.501	112
Baying connector, external	6 pc(s).	8617.502	8617.502	8617.502	112
Glazed door	1 pc(s).	–	–	–	
Comfort handle VX for lock inserts	1 pc(s).	8618.200	8618.200	8618.200	128
Comfort handle VX for lock inserts and padlock	1 pc(s).	8618.230	8618.230	8618.230	128
Comfort handle VX for profile half-cylinders	1 pc(s).	8618.250	8618.250	8618.250	128
Comfort handle VX with security lock insert, lock E1	1 pc(s).	8618.240	8618.240	8618.240	128
Comfort handle VX for ASSA lock system	1 pc(s).	8618.270	8618.270	8618.270	128
Lock inserts		see page	see page	see page	129
180° hinges	4 pc(s).	8618.330	8618.330	8618.330	119
Punched section with mounting flange, 14 x 39 mm, for tubular door frame	4 pc(s).	8619.720	8619.730	8619.720	134
Wiring plan pocket, sheet steel, depth 35 mm	1 pc(s).	4116.500	4118.500	4116.500	135
Wiring plan pocket, sheet steel, depth 90 mm	1 pc(s).	4116.000	4118.000	4116.000	135
Door stay for escape routes	1 pc(s).	8618.400	8618.400	8618.400	136
Ride-up roller	10 pc(s).	8618.420	8618.420	8618.420	136
Mounting plate infill	1 pc(s).	–	–	–	
Punched section with mounting flange 18 x 64 mm for the outer level, in the width	4 pc(s).	8617.030	8617.040	8617.060	164
Punched section with mounting flange 18 x 64 mm for the outer level, in the depth	4 pc(s).	8617.020	8617.020	8617.020	164
Punched section with mounting flange 23 x 64 mm for the inner level, in the width	4 pc(s).	8617.130	8617.140	8617.160	164
Punched section with mounting flange 23 x 64 mm for the inner level, in the depth	4 pc(s).	8617.120	8617.120	8617.120	164
Punched rail 18 x 39 mm for the enclosure depth	4 pc(s).	8617.710	8617.710	8617.710	166
Support strip for the enclosure depth	20 pc(s).	4695.000	4695.000	4695.000	166
C rail 30/15, for the enclosure width	6 pc(s).	4944.000	4945.000	4947.000	167
Support rail 48 x 26 mm, for the enclosure width	2 pc(s).	8617.800	8617.810	8617.830	167
LED system light		see page	see page	see page	177
Earth straps		see page	see page	see page	186
Cable entry plates		8619.800	8619.801	8619.803	198
	Packs of	2 pc(s).	2 pc(s).	4 pc(s).	
Cable entry grommets	8 cables, max. Ø 13 mm	25 pc(s).	4316.000	4316.000	198
	3 cables, max. Ø 21 mm	25 pc(s).	4317.000	4317.000	198
	1 cable, max. Ø 47 mm	25 pc(s).	4318.000	4318.000	198
Connector grommets	10 pc(s).	4311.000	4311.000	4311.000	198
Section for cable entry, centre		8618.800	8618.801	8618.803	199
	Packs of	2 pc(s).	2 pc(s).	4 pc(s).	
Section for cable entry, rear		8618.810	8618.811	8618.813	199
	Packs of	2 pc(s).	2 pc(s).	4 pc(s).	
Cable duct		see page	see page	see page	203
Cable clamp rail, right angle section	2 pc(s).	8619.410	8619.420	8619.440	204

Baying enclosure system VX25

Basic enclosure, height 1600 mm, depth 500 mm

Width (B) mm	Packs of	600	800	1200	Page
Height (H) mm		1600	1600	1600	
Depth (T) mm		500	500	500	
Mounting plate width (F) mm		499	699	1099	
Mounting plate height (G) mm		1496	1496	1496	
Model No.	1 pc(s).	8665.000	8865.000	8265.000	
Weight, approx. kg		81.9	102.0	156.0	
Product-specific scope of supply					
Door(s)		1	1	2	
Accessories					
Base/plinth corner pieces with base/plinth trim panels, front and rear, 100 mm	2 pc(s).	8640.002	8640.003	8640.007	89
Base/plinth trim panels, sides, 100 mm	2 pc(s).	8640.032	8640.032	8640.032	90
Base/plinth corner pieces with base/plinth trim panels, front and rear, 200 mm	2 pc(s).	8640.022	8640.023	8640.025	89
Base/plinth trim panels, sides, 200 mm	2 pc(s).	8640.042	8640.042	8640.042	90
Levelling feet	4 pc(s).	4612.000	4612.000	4612.000	96
Side panels, screw-fastened, sheet steel	2 pc(s).	8165.245	8165.245	8165.245	102
Divider panel	1 pc(s).	–	–	–	
Divider panel for module plates	1 pc(s).	–	–	–	
Baying bracket, internal	6 pc(s).	8617.500	8617.500	8617.500	112
Baying block, internal	6 pc(s).	8617.501	8617.501	8617.501	112
Baying connector, external	6 pc(s).	8617.502	8617.502	8617.502	112
Glazed door	1 pc(s).	–	–	–	
Comfort handle VX for lock inserts	1 pc(s).	8618.200	8618.200	8618.200	128
Comfort handle VX for lock inserts and padlock	1 pc(s).	8618.230	8618.230	8618.230	128
Comfort handle VX for profile half-cylinders	1 pc(s).	8618.250	8618.250	8618.250	128
Comfort handle VX with security lock insert, lock E1	1 pc(s).	8618.240	8618.240	8618.240	128
Comfort handle VX for ASSA lock system	1 pc(s).	8618.270	8618.270	8618.270	128
Lock inserts		see page	see page	see page	129
180° hinges	4 pc(s).	8618.330	8618.330	8618.330	119
Punched section with mounting flange, 14 x 39 mm, for tubular door frame	4 pc(s).	8619.720	8619.730	8619.720	134
Wiring plan pocket, sheet steel, depth 35 mm	1 pc(s).	4116.500	4118.500	4116.500	135
Wiring plan pocket, sheet steel, depth 90 mm	1 pc(s).	4116.000	4118.000	4116.000	135
Door stay for escape routes	1 pc(s).	8618.400	8618.400	8618.400	136
Ride-up roller	10 pc(s).	8618.420	8618.420	8618.420	136
Mounting plate infill	1 pc(s).	–	–	–	
Punched section with mounting flange 18 x 64 mm for the outer level, in the width	4 pc(s).	8617.030	8617.040	8617.060	164
Punched section with mounting flange 18 x 64 mm for the outer level, in the depth	4 pc(s).	8617.020	8617.020	8617.020	164
Punched section with mounting flange 23 x 64 mm for the inner level, in the width	4 pc(s).	8617.130	8617.140	8617.160	164
Punched section with mounting flange 23 x 64 mm for the inner level, in the depth	4 pc(s).	8617.120	8617.120	8617.120	164
Punched rail 18 x 39 mm for the enclosure depth	4 pc(s).	8617.710	8617.710	8617.710	166
Support strip for the enclosure depth	20 pc(s).	4695.000	4695.000	4695.000	166
C rail 30/15, for the enclosure width	6 pc(s).	4944.000	4945.000	4947.000	167
Support rail 48 x 26 mm, for the enclosure width	2 pc(s).	8617.800	8617.810	8617.830	167
LED system light		see page	see page	see page	177
Earth straps		see page	see page	see page	186
Cable entry plates		8619.800	8619.801	8619.803	198
	Packs of	2 pc(s).	2 pc(s).	4 pc(s).	
Cable entry grommets	8 cables, max. Ø 13 mm	25 pc(s).	4316.000	4316.000	198
	3 cables, max. Ø 21 mm	25 pc(s).	4317.000	4317.000	198
	1 cable, max. Ø 47 mm	25 pc(s).	4318.000	4318.000	198
Connector grommets	10 pc(s).	4311.000	4311.000	4311.000	198
Section for cable entry, centre		8618.800	8618.801	8618.803	199
	Packs of	2 pc(s).	2 pc(s).	4 pc(s).	
Section for cable entry, rear		8618.810	8618.811	8618.813	199
	Packs of	2 pc(s).	2 pc(s).	4 pc(s).	
Cable duct		see page	see page	see page	203
Cable clamp rail, right angle section	2 pc(s).	8619.410	8619.420	8619.440	204

Baying enclosure system VX25

Basic enclosure, height 1800 mm, depth 400 mm

Width (B) mm	Packs of	600	800	1000	1000	1200	Page
Height (H) mm		1800	1800	1800	1800	1800	
Depth (T) mm		400	400	400	400	400	
Mounting plate width (F) mm		499	699	899	899	1099	
Mounting plate height (G) mm		1696	1696	1696	1696	1696	
Model No.	1 pc(s).	8684.000	8884.000	8080.000	8084.000	8284.000	
Weight, approx. kg		86.9	109.0	138.0	133.0	166.0	
Product-specific scope of supply							
Door(s)		1	1	2	1	2	
Accessories							
Base/plinth corner pieces with base/plinth trim panels, front and rear, 100 mm	2 pc(s).	8640.002	8640.003	8640.005	8640.005	8640.007	89
Base/plinth trim panels, sides, 100 mm	2 pc(s).	8640.031	8640.031	8640.031	8640.031	8640.031	90
Base/plinth corner pieces with base/plinth trim panels, front and rear, 200 mm	2 pc(s).	8640.022	8640.023	8640.024	8640.024	8640.025	89
Base/plinth trim panels, sides, 200 mm	2 pc(s).	8640.041	8640.041	8640.041	8640.041	8640.041	90
Levelling feet	4 pc(s).	4612.000	4612.000	4612.000	4612.000	4612.000	96
Side panels, screw-fastened, sheet steel	2 pc(s).	8184.245	8184.245	8184.245	8184.245	8184.245	102
Divider panel	1 pc(s).	8609.200	8609.200	8609.200	8609.200	8609.200	104
Divider panel for module plates	1 pc(s).	–	–	–	–	–	
Baying bracket, internal	6 pc(s).	8617.500	8617.500	8617.500	8617.500	8617.500	112
Baying block, internal	6 pc(s).	8617.501	8617.501	8617.501	8617.501	8617.501	112
Baying connector, external	6 pc(s).	8617.502	8617.502	8617.502	8617.502	8617.502	112
Glazed door	1 pc(s).	8618.000	8618.010	–	–	–	118
Comfort handle VX for lock inserts	1 pc(s).	8618.200	8618.200	8618.200	8618.200	8618.200	128
Comfort handle VX for lock inserts and padlock	1 pc(s).	8618.230	8618.230	8618.230	8618.230	8618.230	128
Comfort handle VX for profile half-cylinders	1 pc(s).	8618.250	8618.250	8618.250	8618.250	8618.250	128
Comfort handle VX with security lock insert, lock E1	1 pc(s).	8618.240	8618.240	8618.240	8618.240	8618.240	128
Comfort handle VX for ASSA lock system	1 pc(s).	8618.270	8618.270	8618.270	8618.270	8618.270	128
Lock inserts		see page	see page	see page	see page	see page	129
180° hinges	4 pc(s).	8618.330	8618.330	8618.330	8618.330	8618.330	119
Punched section with mounting flange, 14 x 39 mm, for tubular door frame	4 pc(s).	8619.720	8619.730	8619.710	8619.750	8619.720	134
Wiring plan pocket, sheet steel, depth 35 mm	1 pc(s).	4116.500	4118.500	4115.500	–	4116.500	135
Wiring plan pocket, sheet steel, depth 90 mm	1 pc(s).	4116.000	4118.000	4115.000	4124.000	4116.000	135
Door stay for escape routes	1 pc(s).	8618.400	8618.400	8618.400	8618.400	8618.400	136
Ride-up roller	10 pc(s).	8618.420	8618.420	8618.420	8618.420	8618.420	136
Mounting plate infill	1 pc(s).	4590.700	4590.700	4590.700	4590.700	4590.700	151
Punched section with mounting flange 18 x 64 mm for the outer level, in the width	4 pc(s).	8617.030	8617.040	8617.050	8617.050	8617.060	164
Punched section with mounting flange 18 x 64 mm for the outer level, in the depth	4 pc(s).	8617.010	8617.010	8617.010	8617.010	8617.010	164
Punched section with mounting flange 23 x 64 mm for the inner level, in the width	4 pc(s).	8617.130	8617.140	8617.150	8617.150	8617.160	164
Punched section with mounting flange 23 x 64 mm for the inner level, in the depth	4 pc(s).	8617.110	8617.110	8617.110	8617.110	8617.110	164
Punched rail 18 x 39 mm for the enclosure depth	4 pc(s).	8617.700	8617.700	8617.700	8617.700	8617.700	166
Support strip for the enclosure depth	20 pc(s).	4694.000	4694.000	4694.000	4694.000	4694.000	166
C rail 30/15, for the enclosure width	6 pc(s).	4944.000	4945.000	4946.000	4946.000	4947.000	167
Support rail 48 x 26 mm, for the enclosure width	2 pc(s).	8617.800	8617.810	8617.820	8617.820	8617.830	167
LED system light		see page	see page	see page	see page	see page	177
Earth straps		see page	see page	see page	see page	see page	186
Cable entry plates		8619.800	8619.801	8619.802	8619.802	8619.803	198
	Packs of	2 pc(s).	2 pc(s).	4 pc(s).	4 pc(s).	4 pc(s).	
Cable entry grommets	8 cables, max. Ø 13 mm	25 pc(s).	4316.000	4316.000	4316.000	4316.000	198
	3 cables, max. Ø 21 mm	25 pc(s).	4317.000	4317.000	4317.000	4317.000	198
	1 cable, max. Ø 47 mm	25 pc(s).	4318.000	4318.000	4318.000	4318.000	198
Connector grommets	10 pc(s).	4311.000	4311.000	4311.000	4311.000	4311.000	198
Section for cable entry, centre		8618.800	8618.801	8618.802	8618.802	8618.803	199
	Packs of	2 pc(s).	2 pc(s).	4 pc(s).	4 pc(s).	4 pc(s).	
Section for cable entry, rear		8618.810	8618.811	8618.812	8618.812	8618.813	199
	Packs of	2 pc(s).	2 pc(s).	4 pc(s).	4 pc(s).	4 pc(s).	
Cable duct		see page	see page	see page	see page	see page	203
Cable clamp rail, right angle section	2 pc(s).	8619.410	8619.420	8619.430	8619.430	8619.440	204

Baying enclosure system VX25

Basic enclosure, height 1800 mm, depth 500 mm

Width (B) mm	Packs of	400	600	800	800	1200	Page
Height (H) mm		1800	1800	1800	1800	1800	
Depth (T) mm		500	500	500	500	500	
Mounting plate width (F) mm		299	499	699	699	1099	
Mounting plate height (G) mm		1696	1696	1696	1696	1696	
Model No.	1 pc(s).	8485.000	8685.000	8880.000	8885.000	8285.000	
Weight, approx. kg		66.4	90.0	119.0	113.5	173.0	
Product-specific scope of supply							
Door(s)		1	1	2	1	2	
Accessories							
Base/plinth corner pieces with base/plinth trim panels, front and rear, 100 mm	2 pc(s).	8640.001	8640.002	8640.003	8640.003	8640.007	89
Base/plinth trim panels, sides, 100 mm	2 pc(s).	8640.032	8640.032	8640.032	8640.032	8640.032	90
Base/plinth corner pieces with base/plinth trim panels, front and rear, 200 mm	2 pc(s).	8640.021	8640.022	8640.023	8640.023	8640.025	89
Base/plinth trim panels, sides, 200 mm	2 pc(s).	8640.042	8640.042	8640.042	8640.042	8640.042	90
Levelling feet	4 pc(s).	4612.000	4612.000	4612.000	4612.000	4612.000	96
Side panels, screw-fastened, sheet steel	2 pc(s).	8185.245	8185.245	8185.245	8185.245	8185.245	102
Divider panel	1 pc(s).	8609.201	8609.201	8609.201	8609.201	8609.201	104
Divider panel for module plates	1 pc(s).	8609.210	8609.210	8609.210	8609.210	8609.210	105
Baying bracket, internal	6 pc(s).	8617.500	8617.500	8617.500	8617.500	8617.500	112
Baying block, internal	6 pc(s).	8617.501	8617.501	8617.501	8617.501	8617.501	112
Baying connector, external	6 pc(s).	8617.502	8617.502	8617.502	8617.502	8617.502	112
Glazed door	1 pc(s).	–	8618.000	–	8618.010	–	118
Comfort handle VX for lock inserts	1 pc(s).	8618.200	8618.200	8618.200	8618.200	8618.200	128
Comfort handle VX for lock inserts and padlock	1 pc(s).	8618.230	8618.230	8618.230	8618.230	8618.230	128
Comfort handle VX for profile half-cylinders	1 pc(s).	8618.250	8618.250	8618.250	8618.250	8618.250	128
Comfort handle VX with security lock insert, lock E1	1 pc(s).	8618.240	8618.240	8618.240	8618.240	8618.240	128
Comfort handle VX for ASSA lock system	1 pc(s).	8618.270	8618.270	8618.270	8618.270	8618.270	128
Lock inserts		see page	see page	see page	see page	see page	129
180° hinges	4 pc(s).	8618.330	8618.330	8618.330	8618.330	8618.330	119
Punched section with mounting flange, 14 x 39 mm, for tubular door frame	4 pc(s).	8619.700	8619.720	8619.700	8619.730	8619.720	134
Wiring plan pocket, sheet steel, depth 35 mm	1 pc(s).	–	4116.500	–	4118.500	4116.500	135
Wiring plan pocket, sheet steel, depth 90 mm	1 pc(s).	4114.000	4116.000	4114.000	4118.000	4116.000	135
Door stay for escape routes	1 pc(s).	8618.400	8618.400	8618.400	8618.400	8618.400	136
Ride-up roller	10 pc(s).	8618.420	8618.420	8618.420	8618.420	8618.420	136
Mounting plate infill	1 pc(s).	4590.700	4590.700	4590.700	4590.700	4590.700	151
Punched section with mounting flange 18 x 64 mm for the outer level, in the width	4 pc(s).	8617.010	8617.030	8617.040	8617.040	8617.060	164
Punched section with mounting flange 18 x 64 mm for the outer level, in the depth	4 pc(s).	8617.020	8617.020	8617.020	8617.020	8617.020	164
Punched section with mounting flange 23 x 64 mm for the inner level, in the width	4 pc(s).	8617.110	8617.130	8617.140	8617.140	8617.160	164
Punched section with mounting flange 23 x 64 mm for the inner level, in the depth	4 pc(s).	8617.120	8617.120	8617.120	8617.120	8617.120	164
Punched rail 18 x 39 mm for the enclosure depth	4 pc(s).	8617.710	8617.710	8617.710	8617.710	8617.710	166
Support strip for the enclosure depth	20 pc(s).	4695.000	4695.000	4695.000	4695.000	4695.000	166
C rail 30/15, for the enclosure width	6 pc(s).	–	4944.000	4945.000	4945.000	4947.000	167
Support rail 48 x 26 mm, for the enclosure width	2 pc(s).	–	8617.800	8617.810	8617.810	8617.830	167
LED system light		see page	see page	see page	see page	see page	177
Earth straps		see page	see page	see page	see page	see page	186
Cable entry plates		–	8619.800	8619.801	8619.801	8619.803	198
	Packs of	–	2 pc(s).	2 pc(s).	2 pc(s).	4 pc(s).	
Cable entry grommets	8 cables, max. Ø 13 mm	25 pc(s).	4316.000	4316.000	4316.000	4316.000	198
	3 cables, max. Ø 21 mm	25 pc(s).	4317.000	4317.000	4317.000	4317.000	198
	1 cable, max. Ø 47 mm	25 pc(s).	4318.000	4318.000	4318.000	4318.000	198
Connector grommets	10 pc(s).	4311.000	4311.000	4311.000	4311.000	4311.000	198
Section for cable entry, centre		–	8618.800	8618.801	8618.801	8618.803	199
	Packs of	–	2 pc(s).	2 pc(s).	2 pc(s).	4 pc(s).	
Section for cable entry, rear		–	8618.810	8618.811	8618.811	8618.813	199
	Packs of	–	2 pc(s).	2 pc(s).	2 pc(s).	4 pc(s).	
Cable duct		see page	see page	see page	see page	see page	203
Cable clamp rail, right angle section	2 pc(s).	8619.400	8619.410	8619.420	8619.420	8619.440	204

Baying enclosure system VX25

Basic enclosure, height 1800 mm, depth 600 mm

Width (B) mm	Packs of	400	600	800	800	1200	Page
Height (H) mm		1800	1800	1800	1800	1800	
Depth (T) mm		600	600	600	600	600	
Mounting plate width (F) mm		299	499	699	699	1099	
Mounting plate height (G) mm		1696	1696	1696	1696	1696	
Model No.	1 pc(s).	8486.000	8686.000	8881.000	8886.000	8286.000	
Weight, approx. kg		69.6	92.3	121.0	116.0	174.0	
Product-specific scope of supply							
Door(s)		1	1	2	1	2	
Accessories							
Base/plinth corner pieces with base/plinth trim panels, front and rear, 100 mm	2 pc(s).	8640.001	8640.002	8640.003	8640.003	8640.007	89
Base/plinth trim panels, sides, 100 mm	2 pc(s).	8640.033	8640.033	8640.033	8640.033	8640.033	90
Base/plinth corner pieces with base/plinth trim panels, front and rear, 200 mm	2 pc(s).	8640.021	8640.022	8640.023	8640.023	8640.025	89
Base/plinth trim panels, sides, 200 mm	2 pc(s).	8640.043	8640.043	8640.043	8640.043	8640.043	90
Levelling feet	4 pc(s).	4612.000	4612.000	4612.000	4612.000	4612.000	96
Side panels, screw-fastened, sheet steel	2 pc(s).	8186.245	8186.245	8186.245	8186.245	8186.245	102
Divider panel	1 pc(s).	8609.202	8609.202	8609.202	8609.202	8609.202	104
Divider panel for module plates	1 pc(s).	8609.211	8609.211	8609.211	8609.211	8609.211	105
Baying bracket, internal	6 pc(s).	8617.500	8617.500	8617.500	8617.500	8617.500	112
Baying block, internal	6 pc(s).	8617.501	8617.501	8617.501	8617.501	8617.501	112
Baying connector, external	6 pc(s).	8617.502	8617.502	8617.502	8617.502	8617.502	112
Glazed door	1 pc(s).	–	8618.000	–	8618.010	–	118
Comfort handle VX for lock inserts	1 pc(s).	8618.200	8618.200	8618.200	8618.200	8618.200	128
Comfort handle VX for lock inserts and padlock	1 pc(s).	8618.230	8618.230	8618.230	8618.230	8618.230	128
Comfort handle VX for profile half-cylinders	1 pc(s).	8618.250	8618.250	8618.250	8618.250	8618.250	128
Comfort handle VX with security lock insert, lock E1	1 pc(s).	8618.240	8618.240	8618.240	8618.240	8618.240	128
Comfort handle VX for ASSA lock system	1 pc(s).	8618.270	8618.270	8618.270	8618.270	8618.270	128
Lock inserts		see page	see page	see page	see page	see page	129
180° hinges	4 pc(s).	8618.330	8618.330	8618.330	8618.330	8618.330	119
Punched section with mounting flange, 14 x 39 mm, for tubular door frame	4 pc(s).	8619.700	8619.720	8619.700	8619.730	8619.720	134
Wiring plan pocket, sheet steel, depth 35 mm	1 pc(s).	–	4116.500	–	4118.500	4116.500	135
Wiring plan pocket, sheet steel, depth 90 mm	1 pc(s).	4114.000	4116.000	4114.000	4118.000	4116.000	135
Door stay for escape routes	1 pc(s).	8618.400	8618.400	8618.400	8618.400	8618.400	136
Ride-up roller	10 pc(s).	8618.420	8618.420	8618.420	8618.420	8618.420	136
Mounting plate infill	1 pc(s).	4590.700	4590.700	4590.700	4590.700	4590.700	151
Punched section with mounting flange 18 x 64 mm for the outer level, in the width	4 pc(s).	8617.010	8617.030	8617.040	8617.040	8617.060	164
Punched section with mounting flange 18 x 64 mm for the outer level, in the depth	4 pc(s).	8617.030	8617.030	8617.030	8617.030	8617.030	164
Punched section with mounting flange 23 x 64 mm for the inner level, in the width	4 pc(s).	8617.110	8617.130	8617.140	8617.140	8617.160	164
Punched section with mounting flange 23 x 64 mm for the inner level, in the depth	4 pc(s).	8617.130	8617.130	8617.130	8617.130	8617.130	164
Punched rail 18 x 39 mm for the enclosure depth	4 pc(s).	8617.720	8617.720	8617.720	8617.720	8617.720	166
Support strip for the enclosure depth	20 pc(s).	4696.000	4696.000	4696.000	4696.000	4696.000	166
C rail 30/15, for the enclosure width	6 pc(s).	–	4944.000	4945.000	4945.000	4947.000	167
Support rail 48 x 26 mm, for the enclosure width	2 pc(s).	–	8617.800	8617.810	8617.810	8617.830	167
LED system light		see page	see page	see page	see page	see page	177
Earth straps		see page	see page	see page	see page	see page	186
Cable entry plates		–	8619.800	8619.801	8619.801	8619.803	198
	Packs of	–	2 pc(s).	2 pc(s).	2 pc(s).	4 pc(s).	
Cable entry grommets	8 cables, max. Ø 13 mm	25 pc(s).	4316.000	4316.000	4316.000	4316.000	198
	3 cables, max. Ø 21 mm	25 pc(s).	4317.000	4317.000	4317.000	4317.000	198
	1 cable, max. Ø 47 mm	25 pc(s).	4318.000	4318.000	4318.000	4318.000	198
Connector grommets	10 pc(s).	4311.000	4311.000	4311.000	4311.000	4311.000	198
Section for cable entry, centre		–	8618.800	8618.801	8618.801	8618.803	199
	Packs of	–	2 pc(s).	2 pc(s).	2 pc(s).	4 pc(s).	
Section for cable entry, rear		–	8618.810	8618.811	8618.811	8618.813	199
	Packs of	–	2 pc(s).	2 pc(s).	2 pc(s).	4 pc(s).	
Cable duct		see page	see page	see page	see page	see page	203
Cable clamp rail, right angle section	2 pc(s).	8619.400	8619.410	8619.420	8619.420	8619.440	204

Baying enclosure system VX25

Basic enclosure, height 2000 mm, depth 400 mm

Width (B) mm	Packs of	600	800	1000	1200	Page
Height (H) mm		2000	2000	2000	2000	
Depth (T) mm		400	400	400	400	
Mounting plate width (F) mm		499	699	899	1099	
Mounting plate height (G) mm		1896	1896	1896	1896	
Model No.	1 pc(s).	8604.000	8804.000	8004.000	8204.000	
Weight, approx. kg		95.4	120.0	152.0	183.0	
Product-specific scope of supply						
Door(s)		1	1	2	2	
Accessories						
Base/plinth corner pieces with base/plinth trim panels, front and rear, 100 mm	2 pc(s).	8640.002	8640.003	8640.005	8640.007	89
Base/plinth trim panels, sides, 100 mm	2 pc(s).	8640.031	8640.031	8640.031	8640.031	90
Base/plinth corner pieces with base/plinth trim panels, front and rear, 200 mm	2 pc(s).	8640.022	8640.023	8640.024	8640.025	89
Base/plinth trim panels, sides, 200 mm	2 pc(s).	8640.041	8640.041	8640.041	8640.041	90
Levelling feet	4 pc(s).	4612.000	4612.000	4612.000	4612.000	96
Side panels, screw-fastened, sheet steel	2 pc(s).	8104.245	8104.245	8104.245	8104.245	102
Divider panel	1 pc(s).	8609.203	8609.203	8609.203	8609.203	104
Divider panel for module plates	1 pc(s).	–	–	–	–	
Baying bracket, internal	6 pc(s).	8617.500	8617.500	8617.500	8617.500	112
Baying block, internal	6 pc(s).	8617.501	8617.501	8617.501	8617.501	112
Baying connector, external	6 pc(s).	8617.502	8617.502	8617.502	8617.502	112
Glazed door	1 pc(s).	8618.020	8618.030	–	–	118
Comfort handle VX for lock inserts	1 pc(s).	8618.200	8618.200	8618.200	8618.200	128
Comfort handle VX for lock inserts and padlock	1 pc(s).	8618.230	8618.230	8618.230	8618.230	128
Comfort handle VX for profile half-cylinders	1 pc(s).	8618.250	8618.250	8618.250	8618.250	128
Comfort handle VX with security lock insert, lock E1	1 pc(s).	8618.240	8618.240	8618.240	8618.240	128
Comfort handle VX for ASSA lock system	1 pc(s).	8618.270	8618.270	8618.270	8618.270	128
Lock inserts		see page	see page	see page	see page	129
180° hinges	4 pc(s).	8618.330	8618.330	8618.330	8618.330	119
Punched section with mounting flange, 14 x 39 mm, for tubular door frame	4 pc(s).	8619.720	8619.730	8619.710	8619.720	134
Wiring plan pocket, sheet steel, depth 35 mm	1 pc(s).	4116.500	4118.500	4115.500	4116.500	135
Wiring plan pocket, sheet steel, depth 90 mm	1 pc(s).	4116.000	4118.000	4115.000	4116.000	135
Door stay for escape routes	1 pc(s).	8618.400	8618.400	8618.400	8618.400	136
Ride-up roller	10 pc(s).	8618.420	8618.420	8618.420	8618.420	136
Mounting plate infill	1 pc(s).	4591.700	4591.700	4591.700	4591.700	151
Punched section with mounting flange 18 x 64 mm for the outer level, in the width	4 pc(s).	8617.030	8617.040	8617.050	8617.060	164
Punched section with mounting flange 18 x 64 mm for the outer level, in the depth	4 pc(s).	8617.010	8617.010	8617.010	8617.010	164
Punched section with mounting flange 23 x 64 mm for the inner level, in the width	4 pc(s).	8617.130	8617.140	8617.150	8617.160	164
Punched section with mounting flange 23 x 64 mm for the inner level, in the depth	4 pc(s).	8617.110	8617.110	8617.110	8617.110	164
Punched rail 18 x 39 mm for the enclosure depth	4 pc(s).	8617.700	8617.700	8617.700	8617.700	166
Support strip for the enclosure depth	20 pc(s).	4694.000	4694.000	4694.000	4694.000	166
C rail 30/15, for the enclosure width	6 pc(s).	4944.000	4945.000	4946.000	4947.000	167
Support rail 48 x 26 mm, for the enclosure width	2 pc(s).	8617.800	8617.810	8617.820	8617.830	167
LED system light		see page	see page	see page	see page	177
Earth straps		see page	see page	see page	see page	186
Cable entry plates		8619.800	8619.801	8619.802	8619.803	198
	Packs of	2 pc(s).	2 pc(s).	4 pc(s).	4 pc(s).	
Cable entry grommets	8 cables, max. Ø 13 mm	25 pc(s).	4316.000	4316.000	4316.000	198
	3 cables, max. Ø 21 mm	25 pc(s).	4317.000	4317.000	4317.000	198
	1 cable, max. Ø 47 mm	25 pc(s).	4318.000	4318.000	4318.000	198
Connector grommets	10 pc(s).	4311.000	4311.000	4311.000	4311.000	198
Section for cable entry, centre		8618.800	8618.801	8618.802	8618.803	199
	Packs of	2 pc(s).	2 pc(s).	4 pc(s).	4 pc(s).	
Section for cable entry, rear		8618.810	8618.811	8618.812	8618.813	199
	Packs of	2 pc(s).	2 pc(s).	4 pc(s).	4 pc(s).	
Cable duct		see page	see page	see page	see page	203
Cable clamp rail, right angle section	2 pc(s).	8619.410	8619.420	8619.430	8619.440	204

Baying enclosure system VX25

Basic enclosure, height 2000 mm, depth 500 mm

Width (B) mm	Packs of	400	600	800	1000	1200	Page
Height (H) mm		2000	2000	2000	2000	2000	
Depth (T) mm		500	500	500	500	500	
Mounting plate width (F) mm		299	499	699	899	1099	
Mounting plate height (G) mm		1896	1896	1896	1896	1896	
Model No.	1 pc(s).	8405.000	8605.000	8805.000	8005.000	8205.000	
Weight, approx. kg		73.0	98.0	122.0	156.0	187.0	
Product-specific scope of supply							
Door(s)		1	1	1	2	2	
Accessories							
Base/plinth corner pieces with base/plinth trim panels, front and rear, 100 mm	2 pc(s).	8640.001	8640.002	8640.003	8640.005	8640.007	89
Base/plinth trim panels, sides, 100 mm	2 pc(s).	8640.032	8640.032	8640.032	8640.032	8640.032	90
Base/plinth corner pieces with base/plinth trim panels, front and rear, 200 mm	2 pc(s).	8640.021	8640.022	8640.023	8640.024	8640.025	89
Base/plinth trim panels, sides, 200 mm	2 pc(s).	8640.042	8640.042	8640.042	8640.042	8640.042	90
Levelling feet	4 pc(s).	4612.000	4612.000	4612.000	4612.000	4612.000	96
Side panels, screw-fastened, sheet steel	2 pc(s).	8105.245	8105.245	8105.245	8105.245	8105.245	102
Divider panel	1 pc(s).	8609.204	8609.204	8609.204	8609.204	8609.204	104
Divider panel for module plates	1 pc(s).	8609.212	8609.212	8609.212	8609.212	8609.212	105
Baying bracket, internal	6 pc(s).	8617.500	8617.500	8617.500	8617.500	8617.500	112
Baying block, internal	6 pc(s).	8617.501	8617.501	8617.501	8617.501	8617.501	112
Baying connector, external	6 pc(s).	8617.502	8617.502	8617.502	8617.502	8617.502	112
Glazed door	1 pc(s).	–	8618.020	8618.030	–	–	118
Comfort handle VX for lock inserts	1 pc(s).	8618.200	8618.200	8618.200	8618.200	8618.200	128
Comfort handle VX for lock inserts and padlock	1 pc(s).	8618.230	8618.230	8618.230	8618.230	8618.230	128
Comfort handle VX for profile half-cylinders	1 pc(s).	8618.250	8618.250	8618.250	8618.250	8618.250	128
Comfort handle VX with security lock insert, lock E1	1 pc(s).	8618.240	8618.240	8618.240	8618.240	8618.240	128
Comfort handle VX for ASSA lock system	1 pc(s).	8618.270	8618.270	8618.270	8618.270	8618.270	128
Lock inserts		see page	see page	see page	see page	see page	129
180° hinges	4 pc(s).	8618.330	8618.330	8618.330	8618.330	8618.330	119
Punched section with mounting flange, 14 x 39 mm, for tubular door frame	4 pc(s).	8619.700	8619.720	8619.730	8619.710	8619.720	134
Wiring plan pocket, sheet steel, depth 35 mm	1 pc(s).	–	4116.500	4118.500	4115.500	4116.500	135
Wiring plan pocket, sheet steel, depth 90 mm	1 pc(s).	4114.000	4116.000	4118.000	4115.000	4116.000	135
Door stay for escape routes	1 pc(s).	8618.400	8618.400	8618.400	8618.400	8618.400	136
Ride-up roller	10 pc(s).	8618.420	8618.420	8618.420	8618.420	8618.420	136
Mounting plate infill	1 pc(s).	4591.700	4591.700	4591.700	4591.700	4591.700	151
Punched section with mounting flange 18 x 64 mm for the outer level, in the width	4 pc(s).	8617.010	8617.030	8617.040	8617.050	8617.060	164
Punched section with mounting flange 18 x 64 mm for the outer level, in the depth	4 pc(s).	8617.020	8617.020	8617.020	8617.020	8617.020	164
Punched section with mounting flange 23 x 64 mm for the inner level, in the width	4 pc(s).	8617.110	8617.130	8617.140	8617.150	8617.160	164
Punched section with mounting flange 23 x 64 mm for the inner level, in the depth	4 pc(s).	8617.120	8617.120	8617.120	8617.120	8617.120	164
Punched rail 18 x 39 mm for the enclosure depth	4 pc(s).	8617.710	8617.710	8617.710	8617.710	8617.710	166
Support strip for the enclosure depth	20 pc(s).	4695.000	4695.000	4695.000	4695.000	4695.000	166
C rail 30/15, for the enclosure width	6 pc(s).	–	4944.000	4945.000	4946.000	4947.000	167
Support rail 48 x 26 mm, for the enclosure width	2 pc(s).	–	8617.800	8617.810	8617.820	8617.830	167
LED system light		see page	see page	see page	see page	see page	177
Earth straps		see page	see page	see page	see page	see page	186
Cable entry plates		–	8619.800	8619.801	8619.802	8619.803	198
	Packs of	–	2 pc(s).	2 pc(s).	4 pc(s).	4 pc(s).	
Cable entry grommets	8 cables, max. Ø 13 mm	25 pc(s).	4316.000	4316.000	4316.000	4316.000	198
	3 cables, max. Ø 21 mm	25 pc(s).	4317.000	4317.000	4317.000	4317.000	198
	1 cable, max. Ø 47 mm	25 pc(s).	4318.000	4318.000	4318.000	4318.000	198
Connector grommets	10 pc(s).	4311.000	4311.000	4311.000	4311.000	4311.000	198
Section for cable entry, centre		–	8618.800	8618.801	8618.802	8618.803	199
	Packs of	–	2 pc(s).	2 pc(s).	4 pc(s).	4 pc(s).	
Section for cable entry, rear		–	8618.810	8618.811	8618.812	8618.813	199
	Packs of	–	2 pc(s).	2 pc(s).	4 pc(s).	4 pc(s).	
Cable duct		see page	see page	see page	see page	see page	203
Cable clamp rail, right angle section	2 pc(s).	8619.400	8619.410	8619.420	8619.430	8619.440	204

Baying enclosure system VX25

Basic enclosure, height 2000 mm, depth 600 mm

Width (B) mm	Packs of	400	600	800	1000	1200	Page
Height (H) mm		2000	2000	2000	2000	2000	
Depth (T) mm		600	600	600	600	600	
Mounting plate width (F) mm		299	499	699	899	1099	
Mounting plate height (G) mm		1896	1896	1896	1896	1896	
Model No.	1 pc(s).	8406.000	8606.000	8806.000	8006.000	8206.000	
Weight, approx. kg		75.2	101.0	126.0	160.0	191.0	
Product-specific scope of supply							
Door(s)		1	1	1	2	2	
Accessories							
Base/plinth corner pieces with base/plinth trim panels, front and rear, 100 mm	2 pc(s).	8640.001	8640.002	8640.003	8640.005	8640.007	89
Base/plinth trim panels, sides, 100 mm	2 pc(s).	8640.033	8640.033	8640.033	8640.033	8640.033	90
Base/plinth corner pieces with base/plinth trim panels, front and rear, 200 mm	2 pc(s).	8640.021	8640.022	8640.023	8640.024	8640.025	89
Base/plinth trim panels, sides, 200 mm	2 pc(s).	8640.043	8640.043	8640.043	8640.043	8640.043	90
Levelling feet	4 pc(s).	4612.000	4612.000	4612.000	4612.000	4612.000	96
Side panels, screw-fastened, sheet steel	2 pc(s).	8106.245	8106.245	8106.245	8106.245	8106.245	102
Divider panel	1 pc(s).	8609.205	8609.205	8609.205	8609.205	8609.205	104
Divider panel for module plates	1 pc(s).	8609.213	8609.213	8609.213	8609.213	8609.213	105
Baying bracket, internal	6 pc(s).	8617.500	8617.500	8617.500	8617.500	8617.500	112
Baying block, internal	6 pc(s).	8617.501	8617.501	8617.501	8617.501	8617.501	112
Baying connector, external	6 pc(s).	8617.502	8617.502	8617.502	8617.502	8617.502	112
Glazed door	1 pc(s).	–	8618.020	8618.030	–	–	118
Comfort handle VX for lock inserts	1 pc(s).	8618.200	8618.200	8618.200	8618.200	8618.200	128
Comfort handle VX for lock inserts and padlock	1 pc(s).	8618.230	8618.230	8618.230	8618.230	8618.230	128
Comfort handle VX for profile half-cylinders	1 pc(s).	8618.250	8618.250	8618.250	8618.250	8618.250	128
Comfort handle VX with security lock insert, lock E1	1 pc(s).	8618.240	8618.240	8618.240	8618.240	8618.240	128
Comfort handle VX for ASSA lock system	1 pc(s).	8618.270	8618.270	8618.270	8618.270	8618.270	128
Lock inserts		see page	see page	see page	see page	see page	129
180° hinges	4 pc(s).	8618.330	8618.330	8618.330	8618.330	8618.330	119
Punched section with mounting flange, 14 x 39 mm, for tubular door frame	4 pc(s).	8619.700	8619.720	8619.730	8619.710	8619.720	134
Wiring plan pocket, sheet steel, depth 35 mm	1 pc(s).	–	4116.500	4118.500	4115.500	4116.500	135
Wiring plan pocket, sheet steel, depth 90 mm	1 pc(s).	4114.000	4116.000	4118.000	4115.000	4116.000	135
Door stay for escape routes	1 pc(s).	8618.400	8618.400	8618.400	8618.400	8618.400	136
Ride-up roller	10 pc(s).	8618.420	8618.420	8618.420	8618.420	8618.420	136
Mounting plate infill	1 pc(s).	4591.700	4591.700	4591.700	4591.700	4591.700	151
Punched section with mounting flange 18 x 64 mm for the outer level, in the width	4 pc(s).	8617.010	8617.030	8617.040	8617.050	8617.060	164
Punched section with mounting flange 18 x 64 mm for the outer level, in the depth	4 pc(s).	8617.030	8617.030	8617.030	8617.030	8617.030	164
Punched section with mounting flange 23 x 64 mm for the inner level, in the width	4 pc(s).	8617.110	8617.130	8617.140	8617.150	8617.160	164
Punched section with mounting flange 23 x 64 mm for the inner level, in the depth	4 pc(s).	8617.130	8617.130	8617.130	8617.130	8617.130	164
Punched rail 18 x 39 mm for the enclosure depth	4 pc(s).	8617.720	8617.720	8617.720	8617.720	8617.720	166
Support strip for the enclosure depth	20 pc(s).	4696.000	4696.000	4696.000	4696.000	4696.000	166
C rail 30/15, for the enclosure width	6 pc(s).	–	4944.000	4945.000	4946.000	4947.000	167
Support rail 48 x 26 mm, for the enclosure width	2 pc(s).	–	8617.800	8617.810	8617.820	8617.830	167
LED system light		see page	see page	see page	see page	see page	177
Earth straps		see page	see page	see page	see page	see page	186
Cable entry plates		–	8619.800	8619.801	8619.802	8619.803	198
	Packs of	–	2 pc(s).	2 pc(s).	4 pc(s).	4 pc(s).	
Cable entry grommets	8 cables, max. Ø 13 mm	25 pc(s).	4316.000	4316.000	4316.000	4316.000	198
	3 cables, max. Ø 21 mm	25 pc(s).	4317.000	4317.000	4317.000	4317.000	198
	1 cable, max. Ø 47 mm	25 pc(s).	4318.000	4318.000	4318.000	4318.000	198
Connector grommets	10 pc(s).	4311.000	4311.000	4311.000	4311.000	4311.000	198
Section for cable entry, centre		–	8618.800	8618.801	8618.802	8618.803	199
	Packs of	–	2 pc(s).	2 pc(s).	4 pc(s).	4 pc(s).	
Section for cable entry, rear		–	8618.810	8618.811	8618.812	8618.813	199
	Packs of	–	2 pc(s).	2 pc(s).	4 pc(s).	4 pc(s).	
Cable duct		see page	see page	see page	see page	see page	203
Cable clamp rail, right angle section	2 pc(s).	8619.400	8619.410	8619.420	8619.430	8619.440	204

Baying enclosure system VX25

Basic enclosure, height 2000 mm, depth 800 mm

Width (B) mm	Packs of	600	800	1200	Page
Height (H) mm		2000	2000	2000	
Depth (T) mm		800	800	800	
Mounting plate width (F) mm		499	699	1099	
Mounting plate height (G) mm		1896	1896	1896	
Model No.	1 pc(s).	8608.000	8808.000	8208.000	
Weight, approx. kg		106.0	138.0	201.0	
Product-specific scope of supply					
Door(s)		1	1	2	
Accessories					
Base/plinth corner pieces with base/plinth trim panels, front and rear, 100 mm	2 pc(s).	8640.002	8640.003	8640.007	89
Base/plinth trim panels, sides, 100 mm	2 pc(s).	8640.034	8640.034	8640.034	90
Base/plinth corner pieces with base/plinth trim panels, front and rear, 200 mm	2 pc(s).	8640.022	8640.023	8640.025	89
Base/plinth trim panels, sides, 200 mm	2 pc(s).	8640.044	8640.044	8640.044	90
Levelling feet	4 pc(s).	4612.000	4612.000	4612.000	96
Side panels, screw-fastened, sheet steel	2 pc(s).	8108.245	8108.245	8108.245	102
Divider panel	1 pc(s).	8609.206	8609.206	8609.206	104
Divider panel for module plates	1 pc(s).	-	-	-	
Baying bracket, internal	6 pc(s).	8617.500	8617.500	8617.500	112
Baying block, internal	6 pc(s).	8617.501	8617.501	8617.501	112
Baying connector, external	6 pc(s).	8617.502	8617.502	8617.502	112
Glazed door	1 pc(s).	8618.020	8618.030	-	118
Comfort handle VX for lock inserts	1 pc(s).	8618.200	8618.200	8618.200	128
Comfort handle VX for lock inserts and padlock	1 pc(s).	8618.230	8618.230	8618.230	128
Comfort handle VX for profile half-cylinders	1 pc(s).	8618.250	8618.250	8618.250	128
Comfort handle VX with security lock insert, lock E1	1 pc(s).	8618.240	8618.240	8618.240	128
Comfort handle VX for ASSA lock system	1 pc(s).	8618.270	8618.270	8618.270	128
Lock inserts		see page	see page	see page	129
180° hinges	4 pc(s).	8618.330	8618.330	8618.330	119
Punched section with mounting flange, 14 x 39 mm, for tubular door frame	4 pc(s).	8619.720	8619.730	8619.720	134
Wiring plan pocket, sheet steel, depth 35 mm	1 pc(s).	4116.500	4118.500	4116.500	135
Wiring plan pocket, sheet steel, depth 90 mm	1 pc(s).	4116.000	4118.000	4116.000	135
Door stay for escape routes	1 pc(s).	8618.400	8618.400	8618.400	136
Ride-up roller	10 pc(s).	8618.420	8618.420	8618.420	136
Mounting plate infill	1 pc(s).	4591.700	4591.700	4591.700	151
Punched section with mounting flange 18 x 64 mm for the outer level, in the width	4 pc(s).	8617.030	8617.040	8617.060	164
Punched section with mounting flange 18 x 64 mm for the outer level, in the depth	4 pc(s).	8617.040	8617.040	8617.040	164
Punched section with mounting flange 23 x 64 mm for the inner level, in the width	4 pc(s).	8617.130	8617.140	8617.160	164
Punched section with mounting flange 23 x 64 mm for the inner level, in the depth	4 pc(s).	8617.140	8617.140	8617.140	164
Punched rail 18 x 39 mm for the enclosure depth	4 pc(s).	8617.730	8617.730	8617.730	166
Support strip for the enclosure depth	20 pc(s).	4697.000	4697.000	4697.000	166
C rail 30/15, for the enclosure width	6 pc(s).	4944.000	4945.000	4947.000	167
Support rail 48 x 26 mm, for the enclosure width	2 pc(s).	8617.800	8617.810	8617.830	167
LED system light		see page	see page	see page	177
Earth straps		see page	see page	see page	186
Cable entry plates		8619.800	8619.801	8619.803	198
	Packs of	2 pc(s).	2 pc(s).	4 pc(s).	
Cable entry grommets	8 cables, max. Ø 13 mm	25 pc(s).	4316.000	4316.000	198
	3 cables, max. Ø 21 mm	25 pc(s).	4317.000	4317.000	198
	1 cable, max. Ø 47 mm	25 pc(s).	4318.000	4318.000	198
Connector grommets	10 pc(s).	4311.000	4311.000	4311.000	198
Section for cable entry, centre		8618.800	8618.801	8618.803	199
	Packs of	2 pc(s).	2 pc(s).	4 pc(s).	
Section for cable entry, rear		8618.810	8618.811	8618.813	199
	Packs of	2 pc(s).	2 pc(s).	4 pc(s).	
Cable duct		see page	see page	see page	203
Cable clamp rail, right angle section	2 pc(s).	8619.410	8619.420	8619.440	204

Baying enclosure system VX25

Basic enclosure, height 2200 mm, depth 600 mm

Width (B) mm	Packs of	600	800	1200	Page
Height (H) mm		2200	2200	2200	
Depth (T) mm		600	600	600	
Mounting plate width (F) mm		499	699	1099	
Mounting plate height (G) mm		2096	2096	2096	
Model No.	1 pc(s).	8626.000	8826.000	8226.000	
Weight, approx. kg		106.0	136.0	204.0	
Product-specific scope of supply					
Door(s)		1	1	2	
Accessories					
Base/plinth corner pieces with base/plinth trim panels, front and rear, 100 mm	2 pc(s).	8640.002	8640.003	8640.007	89
Base/plinth trim panels, sides, 100 mm	2 pc(s).	8640.033	8640.033	8640.033	90
Base/plinth corner pieces with base/plinth trim panels, front and rear, 200 mm	2 pc(s).	8640.022	8640.023	8640.025	89
Base/plinth trim panels, sides, 200 mm	2 pc(s).	8640.043	8640.043	8640.043	90
Levelling feet	4 pc(s).	4612.000	4612.000	4612.000	96
Side panels, screw-fastened, sheet steel	2 pc(s).	8126.245	8126.245	8126.245	102
Divider panel	1 pc(s).	8609.207	8609.207	8609.207	104
Divider panel for module plates	1 pc(s).	–	–	–	
Baying bracket, internal	6 pc(s).	8617.500	8617.500	8617.500	112
Baying block, internal	6 pc(s).	8617.501	8617.501	8617.501	112
Baying connector, external	6 pc(s).	8617.502	8617.502	8617.502	112
Glazed door	1 pc(s).	8618.040	8618.050	–	118
Comfort handle VX for lock inserts	1 pc(s).	8618.200	8618.200	8618.200	128
Comfort handle VX for lock inserts and padlock	1 pc(s).	8618.230	8618.230	8618.230	128
Comfort handle VX for profile half-cylinders	1 pc(s).	8618.250	8618.250	8618.250	128
Comfort handle VX with security lock insert, lock E1	1 pc(s).	8618.240	8618.240	8618.240	128
Comfort handle VX for ASSA lock system	1 pc(s).	8618.270	8618.270	8618.270	128
Lock inserts		see page	see page	see page	129
180° hinges	4 pc(s).	8618.330	8618.330	8618.330	119
Punched section with mounting flange, 14 x 39 mm, for tubular door frame	4 pc(s).	8619.720	8619.730	8619.720	134
Wiring plan pocket, sheet steel, depth 35 mm	1 pc(s).	4116.500	4118.500	4116.500	135
Wiring plan pocket, sheet steel, depth 90 mm	1 pc(s).	4116.000	4118.000	4116.000	135
Door stay for escape routes	1 pc(s).	8618.400	8618.400	8618.400	136
Ride-up roller	10 pc(s).	8618.420	8618.420	8618.420	136
Mounting plate infill	1 pc(s).	4592.700	4592.700	4592.700	151
Punched section with mounting flange 18 x 64 mm for the outer level, in the width	4 pc(s).	8617.030	8617.040	8617.060	164
Punched section with mounting flange 18 x 64 mm for the outer level, in the depth	4 pc(s).	8617.030	8617.030	8617.030	164
Punched section with mounting flange 23 x 64 mm for the inner level, in the width	4 pc(s).	8617.130	8617.140	8617.160	164
Punched section with mounting flange 23 x 64 mm for the inner level, in the depth	4 pc(s).	8617.130	8617.130	8617.130	164
Punched rail 18 x 39 mm for the enclosure depth	4 pc(s).	8617.720	8617.720	8617.720	166
Support strip for the enclosure depth	20 pc(s).	4696.000	4696.000	4696.000	166
C rail 30/15, for the enclosure width	6 pc(s).	4944.000	4945.000	4947.000	167
Support rail 48 x 26 mm, for the enclosure width	2 pc(s).	8617.800	8617.810	8617.830	167
LED system light		see page	see page	see page	177
Earth straps		see page	see page	see page	186
Cable entry plates		8619.800	8619.801	8619.803	198
	Packs of	2 pc(s).	2 pc(s).	4 pc(s).	
Cable entry grommets	8 cables, max. Ø 13 mm	25 pc(s).	4316.000	4316.000	198
	3 cables, max. Ø 21 mm	25 pc(s).	4317.000	4317.000	198
	1 cable, max. Ø 47 mm	25 pc(s).	4318.000	4318.000	198
Connector grommets	10 pc(s).	4311.000	4311.000	4311.000	198
Section for cable entry, centre		8618.800	8618.801	8618.803	199
	Packs of	2 pc(s).	2 pc(s).	4 pc(s).	
Section for cable entry, rear		8618.810	8618.811	8618.813	199
	Packs of	2 pc(s).	2 pc(s).	4 pc(s).	
Cable duct		see page	see page	see page	203
Cable clamp rail, right angle section	2 pc(s).	8619.410	8619.420	8619.440	204

Baying enclosure system VX25



System accessories Page 82 VX25 basic enclosure Page 54 VX25 stainless steel Page 75 VX25 EMC-shielded Page 74

Material and surface finish:

- Enclosure frame: Sheet steel, 1.5 mm, dipcoat-primed
- Roof: Sheet steel, 1.5 mm, dipcoat-primed, powder-coated on the outside, textured paint
- Glazed door: Extruded aluminium section, powder-coated, single-pane safety glass, 3 mm
- Rear door: Sheet steel, 2 mm, dipcoat-primed, powder-coated on the outside, textured paint
- Gland plates: Sheet steel, 1.5 mm, zinc-plated

Colour:

- Enclosure frame, door frame, corner pieces, panels: RAL 7035
- Viewing window (printed mask on the inside): RAL 9005

Protection category IP to IEC 60 529:

- IP55

Protection category NEMA:

- NEMA 12

Supply includes:

- Enclosure frame
- Door(s) (r/h hinge, may be swapped to opposite side)
- Roof plate
- Glazed door at front
- Rear door
- Gland plates
- Lock: 3 mm double-bit

Approvals:

- UL
- cUL
- CSA

Further approvals can be found on the Internet.

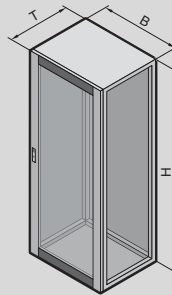

Baying enclosure system VX25

Basic enclosure with glazed door

Width (B) mm	Packs of	600	600	800	800	Page
Height (H) mm		2000	2000	2000	2000	
Depth (T) mm		600	800	600	800	
Model No.	1 pc(s).	8840.120	8840.130	8840.100	8840.110	
Weight kg		71.0	75.4	84.2	90.0	
Accessories						
Base/plinth corner pieces with base/plinth trim panels, front and rear, 100 mm	2 pc(s).	8640.002	8640.002	8640.003	8640.003	89
Base/plinth trim panels, sides, 100 mm	2 pc(s).	8640.033	8640.034	8640.033	8640.034	90
Base/plinth corner pieces with base/plinth trim panels, front and rear, 200 mm	2 pc(s).	8640.022	8640.022	8640.023	8640.023	89
Base/plinth trim panels, sides, 200 mm	2 pc(s).	8640.043	8640.044	8640.043	8640.044	90
Levelling feet	4 pc(s).	4612.000	4612.000	4612.000	4612.000	96
Side panels, screw-fastened, sheet steel	2 pc(s).	8106.245	8108.245	8106.245	8108.245	102
Divider panel	1 pc(s).	8609.205	8609.206	8609.205	8609.206	104
Divider panel for module plates	1 pc(s).	8609.213	–	8609.213	–	105
Baying bracket, internal	6 pc(s).	8617.500	8617.500	8617.500	8617.500	112
Baying block, internal	6 pc(s).	8617.501	8617.501	8617.501	8617.501	112
Baying connector, external	6 pc(s).	8617.502	8617.502	8617.502	8617.502	112
Comfort handle VX for lock inserts	1 pc(s).	8618.200	8618.200	8618.200	8618.200	128
Comfort handle VX for lock inserts and padlock	1 pc(s).	8618.230	8618.230	8618.230	8618.230	128
Comfort handle VX for profile half-cylinders	1 pc(s).	8618.250	8618.250	8618.250	8618.250	128
Comfort handle VX with security lock insert, lock E1	1 pc(s).	8618.240	8618.240	8618.240	8618.240	128
Comfort handle VX for ASSA lock system	1 pc(s).	8618.270	8618.270	8618.270	8618.270	128
Lock inserts		see page	see page	see page	see page	129
180° hinges	4 pc(s).	8618.330	8618.330	8618.330	8618.330	119
Punched section with mounting flange, 14 x 39 mm, for tubular door frame	4 pc(s).	8619.720	8619.720	8619.730	8619.730	134
Wiring plan pocket, sheet steel, depth 35 mm	1 pc(s).	4116.500	4116.500	4118.500	4118.500	135
Wiring plan pocket, sheet steel, depth 90 mm	1 pc(s).	4116.000	4116.000	4118.000	4118.000	135
Door stay	1 pc(s).	8618.430	8618.430	8618.430	8618.430	136
Door stay for escape routes	1 pc(s).	8618.425	8618.425	8618.425	8618.425	136
Ride-up roller	10 pc(s).	8618.420	8618.420	8618.420	8618.420	136
Punched section with mounting flange 18 x 64 mm for the outer level, in the width	4 pc(s).	8617.030	8617.030	8617.040	8617.040	164
Punched section with mounting flange 18 x 64 mm for the outer level, in the depth	4 pc(s).	8617.030	8617.040	8617.030	8617.040	164
Punched section with mounting flange 23 x 64 mm for the inner level, in the width	4 pc(s).	8617.130	8617.130	8617.140	8617.140	164
Punched section with mounting flange 23 x 64 mm for the inner level, in the depth	4 pc(s).	8617.130	8617.140	8617.130	8617.140	164
Punched rail 18 x 39 mm for the enclosure depth	4 pc(s).	8617.720	8617.730	8617.720	8617.730	166
Support strip for the enclosure depth	20 pc(s).	4696.000	4697.000	4696.000	4697.000	166
C rail 30/15, for the enclosure width	6 pc(s).	4944.000	4944.000	4945.000	4945.000	167
Support rail 48 x 26 mm, for the enclosure width	2 pc(s).	8617.800	8617.800	8617.810	8617.810	167
LED system light		see page	see page	see page	see page	177
Earth straps		see page	see page	see page	see page	186
Cable entry plates		8619.800	8619.800	8619.801	8619.801	198
	Packs of	2 pc(s).	2 pc(s).	2 pc(s).	2 pc(s).	
Cable entry grommets	8 cables, max. Ø 13 mm	25 pc(s).	4316.000	4316.000	4316.000	198
	3 cables, max. Ø 21 mm	25 pc(s).	4317.000	4317.000	4317.000	198
	1 cable, max. Ø 47 mm	25 pc(s).	4318.000	4318.000	4318.000	198
Connector grommets	10 pc(s).	4311.000	4311.000	4311.000	4311.000	198
Section for cable entry, centre		8618.800	8618.800	8618.801	8618.801	199
	Packs of	2 pc(s).	2 pc(s).	2 pc(s).	2 pc(s).	
Section for cable entry, rear		8618.810	8618.810	8618.811	8618.811	199
	Packs of	2 pc(s).	2 pc(s).	2 pc(s).	2 pc(s).	
Cable clamp rail, right angle section	2 pc(s).	8619.410	8619.410	8619.420	8619.420	204

Baying enclosure system VX25



System accessories Page 82 482.6 mm (19") installation accessories Page 208

Material and surface finish:

- Enclosure frame: Sheet steel, 1.5 mm, dipcoat-primed
- Roof: Sheet steel, 1.5 mm, dipcoat-primed, powder-coated on the outside, textured paint
- Front frame: Extruded aluminium section, powder-coated
- Rear door: Sheet steel, 2 mm, dipcoat-primed, powder-coated on the outside, textured paint

- Gland plates: Sheet steel, 1.5 mm, zinc-plated
- 482.6 mm (19") adaptor sections: Sheet steel, zinc-plated

Colour:

- RAL 7035

Supply includes:

- Enclosure frame
- Front frame (r/h hinge, held on the left via mechanical snap fasteners)
- Rear door (r/h hinge, may be swapped to opposite side)
- Roof plate
- Gland plates
- Adaptor sections, 482.6 mm (19"), front

Approvals:

- Bureau Veritas

Electronic enclosure

Height units U	Packs of	33	33	42	42	Page
Width mm		600	600	600	600	
Height mm		1600	1600	2000	2000	
Depth mm		600	800	600	800	
Model No.	1 pc(s).	8410.000	8418.000	8430.000	8438.000	
Weight, approx. kg		58.0	63.2	67.8	72.2	

Accessories

Base/plinth corner pieces with base/plinth trim panels, front and rear, 100 mm	2 pc(s).	8640.002	8640.002	8640.002	8640.002	89
Base/plinth trim panels, side, 100 mm	2 pc(s).	8640.033	8640.034	8640.033	8640.034	90
Base/plinth corner pieces with base/plinth trim panels, front and rear, 200 mm	2 pc(s).	8640.022	8640.022	8640.022	8640.022	89
Base/plinth trim panels, side, 200 mm	2 pc(s).	8640.043	8640.044	8640.043	8640.044	90
Levelling feet	4 pc(s).	4612.000	4612.000	4612.000	4612.000	96
Side panels, screw-fastened, sheet steel	2 pc(s).	8166.245	8168.245	8106.245	8108.245	102
Comfort handle VX for lock inserts	1 pc(s).	8618.200	8618.200	8618.200	8618.200	128
Comfort handle VX for lock inserts and padlock	1 pc(s).	8618.230	8618.230	8618.230	8618.230	128
Comfort handle VX for profile half-cylinders	1 pc(s).	8618.250	8618.250	8618.250	8618.250	128
Lock inserts		see page	see page	see page	see page	129
Punched section with mounting flange 18 x 64 mm for the outer level, in the depth	4 pc(s).	8617.030	8617.040	8617.030	8617.040	164
LED system light		see page	see page	see page	see page	177
Section for cable entry, centre	2 pc(s).	8618.800	8618.800	8618.800	8618.800	199
Section for cable entry, rear	2 pc(s).	8618.810	8618.810	8618.810	8618.810	199
Cable clamp rail, right angle section	2 pc(s).	8619.410	8619.410	8619.410	8619.410	204
Adaptor section, 482.6 mm (19")	2 pc(s).	8619.300	8619.300	8619.320	8619.320	211
Adaptor piece, 482.6 mm (19")	4 pc(s).	8619.330	8619.330	8619.330	8619.330	211
Slide rail with attachment on both sides	10 pc(s).	8613.161	8613.181	8613.161	8613.181	212
Slide rail with attachment on one side	10 pc(s).	4531.001	4531.001	4531.001	4531.001	212
482.6 mm (19") fastener, 1 U	24 pc(s).	2090.000	2090.000	2090.000	2090.000	212

Baying enclosure system VX25



System accessories Page 82

Material and surface finish:

- Enclosure frame: Sheet steel, 1.5 mm, dipcoat-primed and powder-coated, textured paint
- Roof: Sheet steel, 1.5 mm, dipcoat-primed and powder-coated, textured paint
- Door: Sheet steel, 2 mm, dipcoat-primed and powder-coated, textured paint
- Rear panel: Sheet steel, 1.5 mm, dipcoat-primed and powder-coated, textured paint
- Gland plate: Sheet steel, 1.5 mm, dipcoat-primed and powder-coated, textured paint
- Mounting plate: Sheet steel, 3 mm, zinc-plated

Colour:

- RAL 7035

Protection category IP to IEC 60 529:

- IP66

Protection category NEMA:

- NEMA 1, 3R, 4, 12

Supply includes:

- Enclosure frame
- Door (r/h hinge, may be swapped to opposite side)
- Roof plate
- Base
- Rear panel
- Mounting plate
- Lock: 3 mm double-bit
- 2 punched rails 18 x 39 mm

Approvals:

- UL
- cUL
- Bureau Veritas

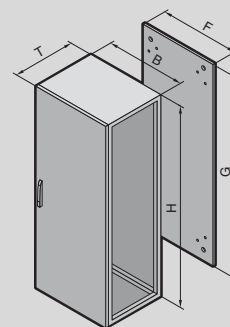

IP66/NEMA 4

Width (B) mm	Packs of	800	Page
Height (H) mm		2000	
Depth (T) mm		600	
Mounting plate width (F) mm		699	
Mounting plate height (G) mm		1896	
Model No.	1 pc(s).	8807.000	
Weight, approx. kg		140.0	

Accessories			
Base/plinth corner pieces with base/plinth trim panels, front and rear, 100 mm	2 pc(s).	8640.003	89
Base/plinth trim panels, sides, 100 mm	2 pc(s).	8640.033	90
Base/plinth corner pieces with base/plinth trim panels, front and rear, 200 mm	2 pc(s).	8640.023	89
Base/plinth trim panels, sides, 200 mm	2 pc(s).	8640.043	90
Levelling feet	4 pc(s).	4612.000	96
Side panels, screw-fastened, sheet steel	2 pc(s).	8106.245	102
Baying bracket, internal	6 pc(s).	8617.500	112
Baying block, internal	6 pc(s).	8617.501	112
Baying connector, external	6 pc(s).	8617.502	112
Comfort handle VX for lock inserts	1 pc(s).	8618.200	128
Comfort handle VX for profile half-cylinders	1 pc(s).	8618.250	128
Wiring plan pocket, sheet steel, depth 35 mm	1 pc(s).	4118.500	135
Wiring plan pocket, sheet steel, depth 90 mm	1 pc(s).	4118.000	135
LED system light		see page	177
Cable duct		see page	203
Cable clamp rail, right angle section	2 pc(s).	8619.420	204

Baying enclosure system VX25



System accessories Page 82 ISV installation modules Page 189 Lock systems Page 126

Material and surface finish:

- Enclosure frame: Sheet steel, 1.5 mm, dipcoat-primed
- Roof: Sheet steel, 1.5 mm, dipcoat-primed, powder-coated on the outside, textured paint
- Door: Sheet steel, 2 mm, dipcoat-primed, powder-coated on the outside, textured paint
- Rear panel: Sheet steel, 1.5 mm, dipcoat-primed, powder-coated on the outside, textured paint
- Gland plates: Sheet steel, 1.5 mm, zinc-plated

Colour:

- RAL 7035

Basis of test:

- IEC 61 439-1/-2

Protection category IP to IEC 60 529:

- IP55

Protection category NEMA:

- NEMA 12

Supply includes:

- Enclosure frame
- Door(s) (r/h hinge, may be swapped to opposite side)
- Gland plates
- Roof plate
- Rear panel
- Lock: 3 mm double-bit

Note:

- For 600 mm wide distribution enclosures, please use basic enclosures, see page 54 onwards
- For a base/plinth height of 200 mm, 2 packs each of plinth corner pieces, 100 mm and base/plinth trim panels, 100 mm are required

Distribution enclosure

Width mm	Packs of	850	1100	850	1100	Page
Height mm		2000	2000	2000	2000	
Depth mm		400	400	600	600	
Model No.	1 pc(s).	9666.956	9666.966	9666.916	9666.926	
Weight, approx. kg		111.0	146.0	117.0	156.0	
Door(s)		1	2	1	2	

Also required

ISV installation kit	1 pc(s).	9666.912	9666.922	9666.912	9666.922	188
Mounting angle	2 pc(s).	9666.712	9666.712	9666.712	9666.712	195
Depth stay for installation kit ISV	2 pc(s).	-	9666.732	-	9666.732	195

Accessories

Base/plinth corner pieces with base/plinth trim panels, front and rear, 100 mm	2 pc(s).	8640.004	8640.006	8640.004	8640.006	89	
Base/plinth trim panels, sides, 100 mm	2 pc(s).	8640.031	8640.031	8640.033	8640.033	90	
Base/plinth corner pieces with base/plinth trim panels, front and rear, 200 mm	2 pc(s).	2 x 8640.004	2 x 8640.006	2 x 8640.004	2 x 8640.006	89	
Base/plinth trim panels, sides, 200 mm	2 pc(s).	2 x 8640.031	2 x 8640.031	2 x 8640.033	2 x 8640.033	90	
Side panels, screw-fastened, sheet steel	2 pc(s).	8104.245	8104.245	8106.245	8106.245	102	
Baying bracket, internal	6 pc(s).	8617.500	8617.500	8617.500	8617.500	112	
Baying block, internal	6 pc(s).	8617.501	8617.501	8617.501	8617.501	112	
Baying connector, external	6 pc(s).	8617.502	8617.502	8617.502	8617.502	112	
Roof plate for cable entry glands	1 pc(s).	9681.594	9681.514	9681.596	9681.516	146	
Cable entry glands	14 x M25/32	1 pc(s).	9665.750	9665.750	9665.750	147	
	2 x M25/32/40, 1 x M32/40/50, 2 x M40/50/63	1 pc(s).	9665.760	9665.760	9665.760	147	
	With sealing membranes 32 x Ø 7 – 16 mm, 4 x Ø 10 – 20 mm, 3 x Ø 14 – 26 mm	1 pc(s).	9665.770	9665.770	9665.770	9665.770	147
	With entry fittings up to Ø 66 mm	1 pc(s).	9665.780	9665.780	9665.780	9665.780	147
	Solid	4 pc(s).	9665.785	9665.785	9665.785	9665.785	147

Baying enclosure system VX25



System accessories Page 82 Installation accessories for modular front design Page 122

Material and surface finish:

- Enclosure frame: Sheet steel, 1.5 mm, dipcoat-primed
- Rear panel: Sheet steel, 1.5 mm, dipcoat-primed, powder-coated on the outside, textured paint
- Gland plates: Sheet steel, 1.5 mm, zinc-plated

Colour:

- RAL 7035

Basis of test:

- IEC 61 439-1/-2
- IEC 61 641

Protection category IP to

IEC 60 529:

- Up to IP54, depending on the panels

Supply includes:

- Enclosure frame
- Rear panel
- Gland plates

Modular enclosure, height 2000 mm

Width mm	Packs of	400	600	800	400	600	800	Page
Height mm		2000	2000	2000	2000	2000	2000	
Depth mm		600	600	600	800	800	800	
Model No.	1 pc(s).	9680.406	9680.606	9680.806	9680.408	9680.608	9680.808	
Weight, approx. kg		43.8	51.0	61.0	46.0	53.7	64.2	
Accessories								
Base/plinth corner pieces with base/plinth trim panels, front and rear, 100 mm	2 pc(s).	8640.001	8640.002	8640.003	8640.001	8640.002	8640.003	89
Base/plinth trim panels, sides, 100 mm	2 pc(s).	8640.033	8640.033	8640.033	8640.034	8640.034	8640.034	90
Base/plinth corner pieces with base/plinth trim panels, front and rear, 200 mm	2 pc(s).	8640.021	8640.022	8640.023	8640.021	8640.022	8640.023	89
Base/plinth trim panels, sides, 200 mm	2 pc(s).	8640.043	8640.043	8640.043	8640.044	8640.044	8640.044	90
Side panels, screw-fastened, sheet steel	2 pc(s).	8106.245	8106.245	8106.245	8108.245	8108.245	8108.245	102
Baying bracket, internal	6 pc(s).	8617.500	8617.500	8617.500	8617.500	8617.500	8617.500	112
Baying block, internal	6 pc(s).	8617.501	8617.501	8617.501	8617.501	8617.501	8617.501	112
Baying connector, external	6 pc(s).	8617.502	8617.502	8617.502	8617.502	8617.502	8617.502	112
Partial doors		see page	see page	see page	see page	see page	see page	123
Front trim panels, top, solid		see page	see page	see page	see page	see page	see page	124
Front trim panels, bottom, solid		see page	see page	see page	see page	see page	see page	124
Front trim panels, bottom, vented	1 pc(s).	9682.354	9682.356	9682.358	9682.354	9682.356	9682.358	124
Roof plate IP55, solid	1 pc(s).	9681.646	9681.666	9681.686	9681.648	9681.668	9681.688	146
Roof plate IP2X with ventilation hole	1 pc(s).	9681.846	9681.866	9681.886	9681.848	9681.868	9681.888	146
Roof plate for cable entry glands	1 pc(s).	9681.546	9681.566	9681.586	9681.548	9681.568	9681.588	146
Cable entry gland		see page	see page	see page	see page	see page	see page	147

Baying enclosure system VX25

Modular enclosure, height 2200 mm

Width mm	Packs of	400	600	800	400	600	800	Page
Height mm		2200	2200	2200	2200	2200	2200	
Depth mm		600	600	600	800	800	800	
Model No.	1 pc(s).	9680.426	9680.626	9680.826	9680.428	9680.628	9680.828	
Weight, approx. kg		43.2	54.0	59.4	46.1	55.8	66.0	
Accessories								
Base/plinth corner pieces with base/plinth trim panels, front and rear, 100 mm	2 pc(s).	8640.001	8640.002	8640.003	8640.001	8640.002	8640.003	89
Base/plinth trim panels, sides, 100 mm	2 pc(s).	8640.033	8640.033	8640.033	8640.034	8640.034	8640.034	90
Base/plinth corner pieces with base/plinth trim panels, front and rear, 200 mm	2 pc(s).	8640.021	8640.022	8640.023	8640.021	8640.022	8640.023	89
Base/plinth trim panels, sides, 200 mm	2 pc(s).	8640.043	8640.043	8640.043	8640.044	8640.044	8640.044	90
Side panels, screw-fastened, sheet steel	2 pc(s).	8126.245	8126.245	8126.245	8128.245	8128.245	8128.245	102
Baying bracket, internal	6 pc(s).	8617.500	8617.500	8617.500	8617.500	8617.500	8617.500	112
Baying block, internal	6 pc(s).	8617.501	8617.501	8617.501	8617.501	8617.501	8617.501	112
Baying connector, external	6 pc(s).	8617.502	8617.502	8617.502	8617.502	8617.502	8617.502	112
Partial doors		see page	see page	see page	see page	see page	see page	123
Front trim panels, top, solid		see page	see page	see page	see page	see page	see page	124
Front trim panels, bottom, solid		see page	see page	see page	see page	see page	see page	124
Front trim panels, bottom, vented	1 pc(s).	9682.354	9682.356	9682.358	9682.354	9682.356	9682.358	124
Roof plate IP55, solid	1 pc(s).	9681.646	9681.666	9681.686	9681.648	9681.668	9681.688	146
Roof plate IP2X with ventilation hole	1 pc(s).	9681.846	9681.866	9681.886	9681.848	9681.868	9681.888	146
Roof plate for cable entry glands	1 pc(s).	9681.546	9681.566	9681.586	9681.548	9681.568	9681.588	146
Cable entry gland		see page	see page	see page	see page	see page	see page	147

Baying enclosure system VX25

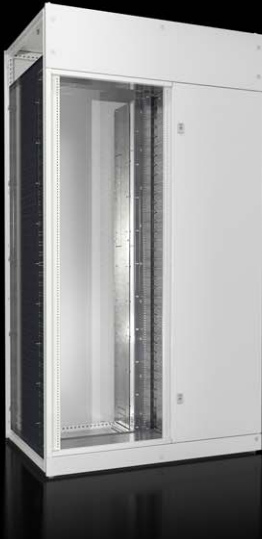

System accessories Page 82 **Compartment configuration** Cat. 36, page 410 **Fuse-switch disconnecter section** Cat.36, page 415

Material and surface finish:

- Enclosure frame: Sheet steel, 1.5 mm, dipcoat-primed
- Roof: Sheet steel, 1.5 mm, dipcoat-primed, powder-coated on the outside, textured paint
- Door: Sheet steel, 2 mm, dipcoat-primed, powder-coated on the outside, textured paint
- Rear panel: Sheet steel, 1.5 mm, dipcoat-primed, powder-coated on the outside, textured paint
- Gland plate: Sheet steel, 1.5 mm, zinc-plated
- Front trim panel: Sheet steel, 1.5 mm, dipcoat-primed, powder-coated on the outside, textured paint
- Compartment side panel: Sheet steel, 1.5 mm, zinc-plated

Colour:

- RAL 7035

Basis of test:

- IEC 61 439-1/-2
- IEC 61 641

Protection category IP to IEC 60 529:

- Up to IP3X, depending on the panels

Supply includes:

- Enclosure frame
- Door
- Roof plate
- Rear panel
- Gland plates
- Front trim panels
- Lock: 3 mm double-bit
- Compartment side panels
- Locating frame for disconnectors with fuses (brands ABB SlimLine/Jean Müller SASIL)

Fuse-switch-disconnector enclosure, height 2000 – 2200 mm

Width mm	Packs of	1000	1200	1000	1200	Page
Height mm		2000	2000	2200	2200	
Depth mm		600	800	600	800	
Model No.	1 pc(s).	9680.005	9680.207	9680.025	9680.227	
Weight kg		125.3	149.6	135.2	158.9	

Accessories

Base/plinth corner pieces with base/plinth trim panels, front and rear, 100 mm	2 pc(s).	8640.005	8640.007	8640.005	8640.007	89
Base/plinth trim panels, sides, 100 mm	2 pc(s).	8640.033	8640.034	8640.033	8640.034	90
Base/plinth corner pieces with base/plinth trim panels, front and rear, 200 mm	2 pc(s).	8640.024	8640.025	8640.024	8640.025	89
Base/plinth trim panels, sides, 200 mm	2 pc(s).	8640.043	8640.044	8640.043	8640.044	90
Side panels, screw-fastened, sheet steel	2 pc(s).	8106.245	8108.245	8126.245	8128.245	102
Baying bracket, internal	6 pc(s).	8617.500	8617.500	8617.500	8617.500	112
Baying block, internal	6 pc(s).	8617.501	8617.501	8617.501	8617.501	112
Baying connector, external	6 pc(s).	8617.502	8617.502	8617.502	8617.502	112
Roof plate IP2X with ventilation hole	1 pc(s).	9681.806	9681.828	9681.806	9681.828	146

Baying enclosure system VX25



System accessories Page 877 **VX25 Basic enclosure** Page 116 **VX25 stainless steel** Page 242

The large enclosures in the VX25 series offer a good level of shielding across a broad frequency range, even in the standard version. For increased EMC requirements, Rittal's VX25 enclosure is also available in a high RF attenuation version.

Material and surface finish:

- Enclosure frame: Sheet steel, 1.5 mm, with magnesium zinc coating
- Roof: Sheet steel, 1.5 mm, with magnesium zinc coating, spray-finished on the outside and paint-free on the inside

- Door: Sheet steel, 2 mm, with magnesium zinc coating, spray-finished on the outside and paint-free on the inside
- Rear panel: Sheet steel, 1.5 mm, with magnesium zinc coating, spray-finished on the outside and paint-free on the inside
- Gland plates: Sheet steel, 1.5 mm, zinc-plated
- Mounting plate: Sheet steel, 3 mm, zinc-plated

Colour:

- RAL 7035

Protection category IP to IEC 60 529:

- IP55

Protection category NEMA:

- NEMA 12

Supply includes:

- Enclosure frame
- Door(s) (door hinge on the right, may be swapped to the left)
- Rear panel
- Roof plate
- Gland plates
- Mounting plate
- Lock: 3 mm double-bit
- 2 punched rails 18 x 39 mm

Note:

- For bayed enclosures, the EMC shielding seal is required

Approvals:

- UL
- cUL

Further approvals can be found on the Internet.

EMC enclosure

Width mm	Packs of	800	800	Page
Height mm		2000	2000	
Depth mm		600	800	
Model No.	1 pc(s).	8807.010	8807.020	
Weight kg		130.0	135.0	

Accessories				
Base/plinth corner pieces with base/plinth trim panels, front and rear, 100 mm	2 pc(s).	8640.003	8640.003	89
Base/plinth trim panels, sides, 100 mm	2 pc(s).	8640.033	8640.034	90
Base/plinth corner pieces with base/plinth trim panels, front and rear, 200 mm	2 pc(s).	8640.023	8640.023	89
Base/plinth trim panels, sides, 200 mm	2 pc(s).	8640.043	8640.044	90
EMC side panels	2 pc(s).	8106.760	8108.760	181
EMC shielding seal	1 pc(s).	8800.695	8800.695	181
Divider panel	1 pc(s).	8609.205	8609.206	104
EMC divider panel seal	1 pc(s).	4348.500	4348.500	181
Rail for EMC shielding bracket	1 pc(s).	2388.850	2388.850	182
EMC shielding bracket		see page	see page	182
EMC shield bus		see page	see page	183
EMC gland plates	1 pc(s).	8618.821	8618.821	182
EMC earth clamps		see page	see page	183
EMC cable glands		see page	see page	183
Cable duct		see page	see page	203
LED system light		see page	see page	177
Earth strap		see page	see page	186
Earthing braid		see page	see page	186
Comfort handle VX		see page	see page	128

Baying enclosure system VX25, stainless steel



Lock systems Page 128 VX25, sheet steel Page 54

Material and surface finish:

- Enclosure frame: Stainless steel 1.4301 (AISI 304), 1.5 mm
- Roof: Stainless steel 1.4301 (AISI 304), 1.5 mm, exterior brushed, grain size 400
- Door: Stainless steel 1.4301 (AISI 304), 2 mm, exterior brushed, grain size 400
- Rear panel: Stainless steel 1.4301 (AISI 304), 1.5 mm, exterior brushed, grain size 400
- Gland plates: Stainless steel 1.4301 (AISI 304), 1.5 mm
- Mounting plate: Sheet steel, 3 mm, zinc-plated

Protection category IP to IEC 60 529:

- IP55

Protection category NEMA:

- NEMA 1, 12

Supply includes:

- Enclosure frame
- Door(s) (r/h hinge, may be swapped to opposite side)
- Roof plate
- Gland plates
- Rear panel
- Mounting plate
- Lock: 3 mm double-bit
- 2 punched rails 18 x 39 mm

Note:

- Due to the hardness of the material, we recommend using metal multi-tooth screw 2486.400 for the interior installation

Approvals:

- UL
- cUL
- DNV-GL

Further approvals can be found on the Internet.

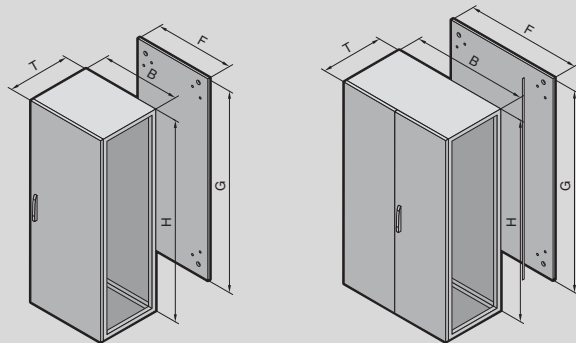

Baying enclosure system VX25, stainless steel

Basic enclosure, height 1800 mm, depth 400 mm

Width (B) mm	Packs of	800	1200	Page
Height (H) mm		1800	1800	
Depth (T) mm		400	400	
Mounting plate width (F) mm		699	1099	
Mounting plate height (G) mm		1696	1696	
Model No.	1 pc(s).	8454.000	8456.000	
Weight, approx. kg		110.0	167.0	
Product-specific scope of supply				
Door(s)		1	2	
Accessories				
Base/plinth corner pieces with base/plinth trim panels, front and rear, 100 mm	2 pc(s).	8620.051	8620.053	91
Base/plinth trim panels, sides, 100 mm	2 pc(s).	8620.070	8620.070	92
Base/plinth corner pieces with base/plinth trim panels, front and rear, 200 mm	2 pc(s).	8620.061	8620.063	91
Base/plinth trim panels, sides, 200 mm	2 pc(s).	8620.080	8620.080	92
Levelling feet	4 pc(s).	8100.780	8100.780	96
Punched section with mounting flange 23 x 89 mm, stainless steel, in the depth	4 pc(s).	8100.730	8100.730	165
Side panels, screw-fastened, stainless steel	2 pc(s).	8700.030	8700.030	102
Divider panel	1 pc(s).	8609.200	8609.200	104
Divider panel for module plates	1 pc(s).	-	-	
Baying bracket, internal	6 pc(s).	8617.500	8617.500	112
Baying block, internal	6 pc(s).	8617.501	8617.501	112
Baying connector, external, stainless steel	6 pc(s).	8617.503	8617.503	112
Comfort handle VX for lock inserts	1 pc(s).	8618.220	8618.220	128
Comfort handle VX for profile half-cylinders	1 pc(s).	8618.280	8618.280	128
Lock inserts		see page	see page	129
180° hinges, stainless steel	4 pc(s).	8618.340	8618.340	119
Punched section with mounting flange, 14 x 39 mm, for tubular door frame	4 pc(s).	8619.730	8619.720	134
Wiring plan pocket, sheet steel, depth 35 mm	1 pc(s).	4118.500	4116.500	135
Wiring plan pocket, sheet steel, depth 90 mm	1 pc(s).	4118.000	4116.000	135
Door stay for escape routes	1 pc(s).	8618.400	8618.400	136
Ride-up roller	10 pc(s).	8618.420	8618.420	136
Mounting plate infill	1 pc(s).	4590.700	4590.700	151
Punched section with mounting flange 18 x 64 mm for the outer level, in the width	4 pc(s).	8617.040	8617.060	164
Punched section with mounting flange 18 x 64 mm for the outer level, in the depth	4 pc(s).	8617.010	8617.010	164
Punched section with mounting flange 23 x 64 mm for the inner level, in the width	4 pc(s).	8617.140	8617.160	164
Punched section with mounting flange 23 x 64 mm for the inner level, in the depth	4 pc(s).	8617.110	8617.110	164
Punched rail 18 x 39 mm for the enclosure depth	4 pc(s).	8617.700	8617.700	166
Support strip for the enclosure depth	20 pc(s).	4694.000	4694.000	166
C rail 30/15, for the enclosure width	6 pc(s).	4945.000	4947.000	167
Support rail 48 x 26 mm, for the enclosure width	2 pc(s).	8617.810	8617.830	167
LED system light		see page	see page	177
Earth straps		see page	see page	186
Section for cable entry, centre		8618.801	8618.803	199
	Packs of	2 pc(s).	4 pc(s).	
Section for cable entry, rear		8618.811	8618.813	199
	Packs of	2 pc(s).	4 pc(s).	
Cable duct		see page	see page	203
Metal multi-tooth screws	300 pc(s).	2486.400	2486.400	172
Cable clamp rail, right angle section	2 pc(s).	8619.420	8619.440	204

Baying enclosure system VX25, stainless steel

Basic enclosure, height 1800 mm, depth 500 mm

Width (B) mm	Packs of	600	800	1200	Page
Height (H) mm		1800	1800	1800	
Depth (T) mm		500	500	500	
Mounting plate width (F) mm		499	699	1099	
Mounting plate height (G) mm		1696	1696	1696	
Model No.	1 pc(s).	8457.000	8455.000	8453.000	
Weight, approx. kg		91.8	113.0	172.0	
Product-specific scope of supply					
Door(s)		1	1	2	
Accessories					
Base/plinth corner pieces with base/plinth trim panels, front and rear, 100 mm	2 pc(s).	8620.050	8620.051	8620.053	91
Base/plinth trim panels, sides, 100 mm	2 pc(s).	8620.071	8620.071	8620.071	92
Base/plinth corner pieces with base/plinth trim panels, front and rear, 200 mm	2 pc(s).	8620.060	8620.061	8620.063	91
Base/plinth trim panels, sides, 200 mm	2 pc(s).	8620.081	8620.081	8620.081	92
Levelling feet	4 pc(s).	8100.780	8100.780	8100.780	96
Punched section with mounting flange 23 x 89 mm, stainless steel, in the depth	4 pc(s).	8100.731	8100.731	8100.731	165
Side panels, screw-fastened, stainless steel	2 pc(s).	8700.040	8700.040	8700.040	102
Divider panel	1 pc(s).	8609.201	8609.201	8609.201	104
Divider panel for module plates	1 pc(s).	8609.210	8609.210	8609.210	105
Baying bracket, internal	6 pc(s).	8617.500	8617.500	8617.500	112
Baying block, internal	6 pc(s).	8617.501	8617.501	8617.501	112
Baying connector, external, stainless steel	6 pc(s).	8617.503	8617.503	8617.503	112
Comfort handle VX for lock inserts	1 pc(s).	8618.220	8618.220	8618.220	128
Comfort handle VX for profile half-cylinders	1 pc(s).	8618.280	8618.280	8618.280	128
Lock inserts		see page	see page	see page	129
180° hinges, stainless steel	4 pc(s).	8618.340	8618.340	8618.340	119
Punched section with mounting flange, 14 x 39 mm, for tubular door frame	4 pc(s).	8619.720	8619.730	8619.720	134
Wiring plan pocket, sheet steel, depth 35 mm	1 pc(s).	4116.500	4118.500	4116.500	135
Wiring plan pocket, sheet steel, depth 90 mm	1 pc(s).	4116.000	4118.000	4116.000	135
Door stay for escape routes	1 pc(s).	8618.400	8618.400	8618.400	136
Ride-up roller	10 pc(s).	8618.420	8618.420	8618.420	136
Mounting plate infill	1 pc(s).	4590.700	4590.700	4590.700	151
Punched section with mounting flange 18 x 64 mm for the outer level, in the width	4 pc(s).	8617.030	8617.040	8617.060	164
Punched section with mounting flange 18 x 64 mm for the outer level, in the depth	4 pc(s).	8617.020	8617.020	8617.020	164
Punched section with mounting flange 23 x 64 mm for the inner level, in the width	4 pc(s).	8617.130	8617.140	8617.160	164
Punched section with mounting flange 23 x 64 mm for the inner level, in the depth	4 pc(s).	8617.120	8617.120	8617.120	164
Punched rail 18 x 39 mm for the enclosure depth	4 pc(s).	8617.710	8617.710	8617.710	166
Support strip for the enclosure depth	20 pc(s).	4695.000	4695.000	4695.000	166
C rail 30/15, for the enclosure width	6 pc(s).	4944.000	4945.000	4947.000	167
Support rail 48 x 26 mm, for the enclosure width	2 pc(s).	8617.800	8617.810	8617.830	167
LED system light		see page	see page	see page	177
Earth straps		see page	see page	see page	186
Section for cable entry, centre		8618.800	8618.801	8618.803	199
	Packs of	2 pc(s).	2 pc(s).	4 pc(s).	
Section for cable entry, rear		8618.810	8618.811	8618.813	199
	Packs of	2 pc(s).	2 pc(s).	4 pc(s).	
Cable duct		see page	see page	see page	203
Metal multi-tooth screws	300 pc(s).	2486.400	2486.400	2486.400	172
Cable clamp rail, right angle section	2 pc(s).	8619.410	8619.420	8619.440	204

Baying enclosure system VX25, stainless steel

Basic enclosure, height 2000 mm, depth 600 mm

Width (B) mm	Packs of	600	800	1200	Page
Height (H) mm		2000	2000	2000	
Depth (T) mm		600	600	600	
Mounting plate width (F) mm		499	699	1099	
Mounting plate height (G) mm		1896	1896	1896	
Model No.	1 pc(s).	8452.000	8450.000	8451.000	
Weight, approx. kg		101.0	126.0	191.0	
Product-specific scope of supply					
Door(s)		1	1	2	
Accessories					
Base/plinth corner pieces with base/plinth trim panel, front and rear, 100 mm	2 pc(s).	8620.050	8620.051	8620.053	91
Base/plinth trim panels, sides, 100 mm	2 pc(s).	8620.072	8620.072	8620.072	92
Base/plinth corner pieces with base/plinth trim panel, front and rear, 200 mm	2 pc(s).	8620.060	8620.061	8620.063	91
Base/plinth trim panels, sides, 200 mm	2 pc(s).	8620.082	8620.082	8620.082	92
Levelling feet	4 pc(s).	8100.780	8100.780	8100.780	96
Punched section with mounting flange 23 x 89 mm, stainless steel, in the depth	4 pc(s).	8100.732	8100.732	8100.732	165
Side panels, screw-fastened, stainless steel	2 pc(s).	8700.050	8700.050	8700.050	102
Divider panel	1 pc(s).	8609.205	8609.205	8609.205	104
Divider panel for module plates	1 pc(s).	8609.213	8609.213	8609.213	105
Baying bracket, internal	6 pc(s).	8617.500	8617.500	8617.500	112
Baying block, internal	6 pc(s).	8617.501	8617.501	8617.501	112
Baying connector, external, stainless steel	6 pc(s).	8617.503	8617.503	8617.503	112
Comfort handle VX for lock inserts	1 pc(s).	8618.220	8618.220	8618.220	128
Comfort handle VX for profile half-cylinders	1 pc(s).	8618.280	8618.280	8618.280	128
Lock inserts		see page	see page	see page	129
180° hinges, stainless steel	4 pc(s).	8618.340	8618.340	8618.340	119
Punched section with mounting flange, 14 x 39 mm, for tubular door frame	4 pc(s).	8619.720	8619.730	8619.720	134
Wiring plan pocket, sheet steel, depth 35 mm	1 pc(s).	4116.500	4118.500	4116.500	135
Wiring plan pocket, sheet steel, depth 90 mm	1 pc(s).	4116.000	4118.000	4116.000	135
Door stay for escape routes	1 pc(s).	8618.400	8618.400	8618.400	136
Ride-up roller	10 pc(s).	8618.420	8618.420	8618.420	136
Mounting plate infill	1 pc(s).	4591.700	4591.700	4591.700	151
Punched section with mounting flange 18 x 64 mm for the outer level, in the width	4 pc(s).	8617.030	8617.040	8617.060	164
Punched section with mounting flange 18 x 64 mm for the outer level, in the depth	4 pc(s).	8617.030	8617.030	8617.030	164
Punched section with mounting flange 23 x 64 mm for the inner level, in the width	4 pc(s).	8617.130	8617.140	8617.160	164
Punched section with mounting flange 23 x 64 mm for the inner level, in the depth	4 pc(s).	8617.130	8617.130	8617.130	164
Punched rail 18 x 39 mm for the enclosure depth	4 pc(s).	8617.720	8617.720	8617.720	166
Support strip for the enclosure depth	20 pc(s).	4696.000	4696.000	4696.000	166
C rail 30/15, for the enclosure width	6 pc(s).	4944.000	4945.000	4947.000	167
Support rail 48 x 26 mm, for the enclosure width	2 pc(s).	8617.800	8617.810	8617.830	167
LED system light		see page	see page	see page	177
Earth straps		see page	see page	see page	186
Section for cable entry, centre		8618.800	8618.801	8618.803	199
	Packs of	2 pc(s).	2 pc(s).	4 pc(s).	
Section for cable entry, rear		8618.810	8618.811	8618.813	199
	Packs of	2 pc(s).	2 pc(s).	4 pc(s).	
Cable duct		see page	see page	see page	203
Metal multi-tooth screws	300 pc(s).	2486.400	2486.400	2486.400	172
Cable clamp rail, right angle section	2 pc(s).	8619.410	8619.420	8619.440	204

Baying enclosure system VX25, stainless steel



System accessories Page 82 Cable entry Page 198

Material and surface finish:

- Enclosure frame: Stainless steel 1.4301 (AISI 304), 1.5 mm
- Roof: Stainless steel 1.4301 (AISI 304), 1.5 mm, exterior brushed, grain size 400
- Door: Stainless steel 1.4301 (AISI 304), 2 mm, exterior brushed, grain size 400
- Rear panel: Stainless steel 1.4301 (AISI 304), 1.5 mm, exterior brushed, grain size 400
- Gland plates: Stainless steel 1.4301 (AISI 304), 1.5 mm
- Mounting plate: Sheet steel, 3 mm, zinc-plated

Supply includes:

- Enclosure frame
- Door(s) (r/h hinge, may be swapped to opposite side)
- Roof
- Gland plate
- Rear panel
- Mounting plate
- Lock: 3 mm double-bit
- 2 punched rails 18 x 39 mm

Note:

- Due to the hardness of the material, we recommend using metal multi-tooth screw 2486.400 for the interior installation

Approvals:

- UL
- cUL

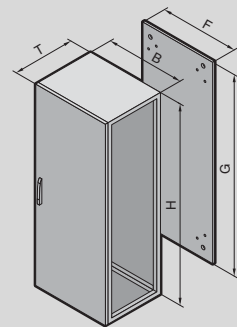

Protection category IP to IEC 60 529:

- IP66

Protection category NEMA:

- NEMA 1, 3R, 4, 4X, 12

IP66/NEMA 4X

Width (B) mm	Packs of	800	Page
Height (H) mm		2000	
Depth (T) mm		600	
Mounting plate width (F) mm		699	
Mounting plate height (G) mm		1896	
Model No.	1 pc(s).	8458.000	
Weight, approx. kg		129.0	
Accessories			
Base/plinth corner pieces with base/plinth trim panels, front and rear, 100 mm	2 pc(s).	8620.051	91
Base/plinth trim panels, sides, 100 mm	2 pc(s).	8620.072	92
Base/plinth corner pieces with base/plinth trim panels, front and rear, 200 mm	2 pc(s).	8620.061	91
Base/plinth trim panels, sides, 200 mm	2 pc(s).	8620.082	92
Punched section with mounting flange 23 x 89 mm, stainless steel, in the depth	4 pc(s).	8100.732	165
Side panels, screw-fastened, stainless steel	2 pc(s).	8700.050	102
Baying bracket, internal	6 pc(s).	8617.500	112
Baying block, internal	6 pc(s).	8617.501	112
Comfort handle VX for lock inserts	1 pc(s).	8618.220	128
Comfort handle VX for profile half-cylinders	1 pc(s).	8618.280	128
Lock inserts		see page	129
Wiring plan pocket, sheet steel, depth 35 mm	1 pc(s).	4118.500	135
Wiring plan pocket, sheet steel, depth 90 mm	1 pc(s).	4118.000	135
LED system light		see page	177
Cable duct		see page	203
Cable clamp rail, right angle section	2 pc(s).	8619.420	204

Perfect integration into bayed enclosure suites

VX25 TopTherm chillers

VX25 TopTherm chillers are compact in design and cover a diversity of applications. They integrate perfectly with the enclosure – as series products promising a minimised footprint, increased efficiency and fast availability.

The benefits for you:



- Up to 35% smaller CO₂ footprint
- Microchannel technology reduces the volume of refrigerant required
- Integral safety functions create enhanced safety
- Minimum footprint
- A single housing size for four output categories
- Convenient servicing



40%



less **refrigerant**

Up to

35%



smaller **CO₂ footprint**

34%



smaller **footprint**

Less complexity

- Fast parameterisation, data reading as well as plain-text system and error messages on the smart, multilingual, industry-grade touch display
- Simple configuration with the chiller configurator
- Predefined options shorten delivery times
- Suitable for global use with a dual-frequency connection voltage

Sustainable technology

- Proven energy savings; the carbon footprint is reduced by up to 35%
- Microchannel technology uses 40% less refrigerant
- Eliminates the requirement for an annual leak test, for significantly reduced maintenance costs

Perfect integration

- Integrated into the VX25 baying system and therefore perfect for baying in an enclosure suite
- 20 kW output category on a footprint of just 0.48 m²
- One enclosure system for four output categories (8 to 20 kW)
- Compatible VX25 system accessories for assembly, baying and attachment

Enhanced safety

- Integrated safety functions (overflow valve, flow monitor and fill level and phase rotation monitoring)
- Pre-installed external NTC sensor for ambient temperature-led differential control
- Prolonged component life and high levels of machining accuracy with precise temperature control (± 1 K)
- Smart interfaces support remote monitoring

High availability

- Fast delivery off the shelf
- Qualified service technicians help to minimise downtime and boost efficiency
- Excellent availability of original spare parts and 24-hour contactability
- Modular design for optimum accessibility





SYSTEM ACCESSORIES – ADDED INSTALLATION OPTIONS

CONTENTS

Base/plinths.....	from page 84
Walls.....	from page 100
Baying system.....	from page 110
Door variants.....	from page 116
Lock systems.....	from page 126
Door installation.....	from page 132
Roof.....	from page 142
Mounting plates.....	from page 148
Rail systems.....	from page 162
Interior installation.....	from page 174
Cable management.....	from page 196
482.6 mm (19") installation system.....	from page 206
Technical information.....	from page 213
Technical details.....	from page 216



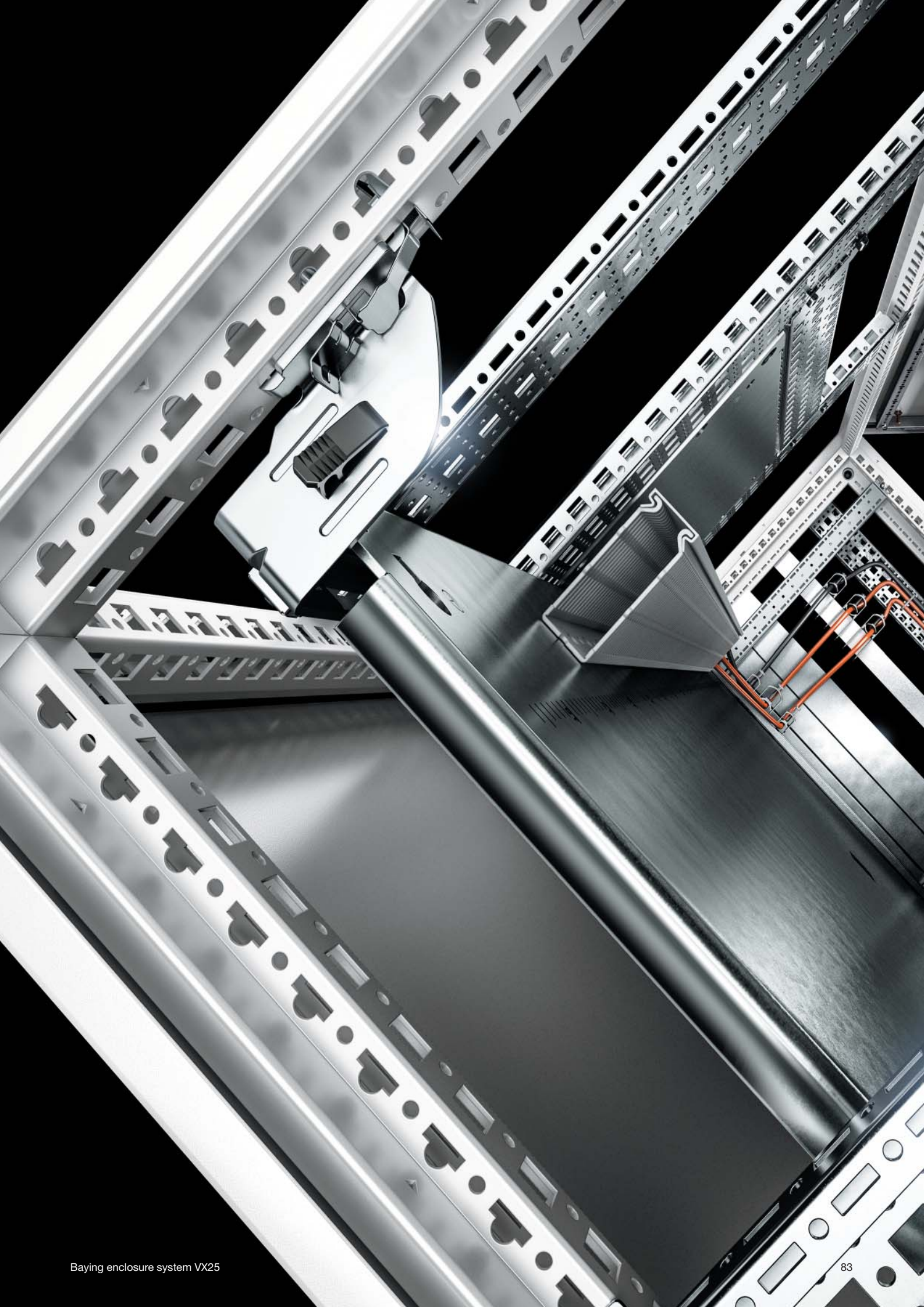

Base/plinth system VX



Integral centring aid
The centring aid for base/plinth mounting on the enclosure frame ensures precise positioning of the enclosure on the base/plinth.

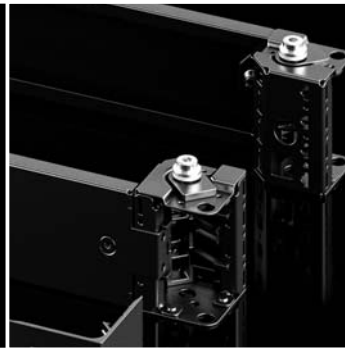

Separate trim panels
Screw-fastened trim panels from the front ensure high stability and easy access to the cable management level behind.



Enclosure attachment
The nuts integrated into the base/plinth corner piece allow screw-fastening directly from above, through the stable base frame, or from below, into the enclosure corner piece. The reinforcement brackets on the base/plinth corner ensure greater stability.



Simple cable management
Secure cable attachment and cable routing via the punched section with mounting flange in the base/plinth.



Additional cable chamber
Gain space with simple integration of the cable clamping rail and C rail for secure, user-friendly cable routing.

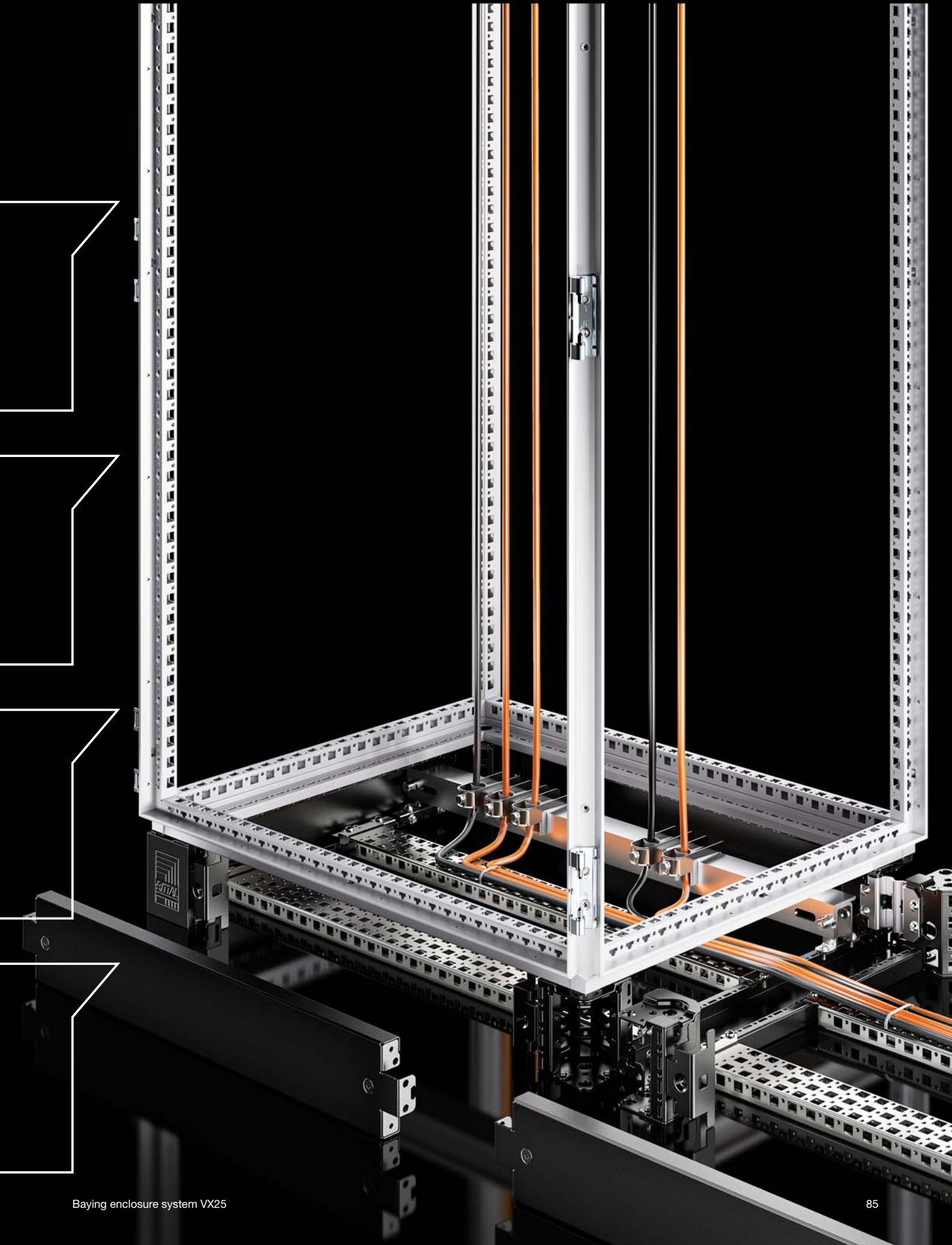

Base/plinth system VX

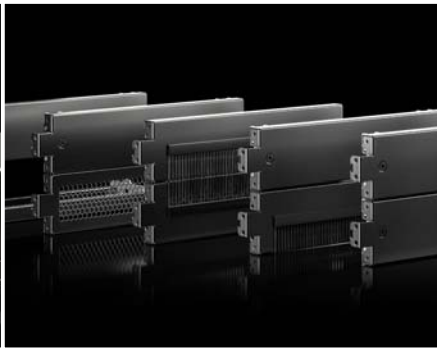

Base/plinth system VX

All trim panels may optionally be clipped into the corner piece, or securely screw-fastened. Depending on the application, users can dispense with the trim panels between bayed enclosure suites, or a 100 mm high trim panel may be used to stabilise the base/plinth corner pieces.



Trim panels

The solid trim panels supplied as standard are easily replaced with vented trim panels or trim panels with brush strips. Two 100 mm high trim panels may also be used in a 200 mm high base/plinth.



Twin castors

The twin castors may be screw-fastened directly to the enclosure corner piece from the outside. Mounting on the VX base/plinth system is also supported via an adaptor.



Transportation

Easily transported by forklift or lifting truck with the front trim panel dismantled, even with bayed enclosures.



Base mounting plate

With the base mounting plate, the base/plinth is easily and securely attached to its final position on the floor, even retrospectively with the enclosure already fitted. Assembly occurs via the large base opening in the enclosure.



Levelling component

The levelling component may be used for retrospective levelling on uneven floors. Unevenness of up to 15 mm can be compensated in this way.

Base/plinth system VX



Base/plinth

Base/plinth system VX

Modular base/plinth diversity

The new, innovative base/plinth system VX offers an unprecedented diversity of functions and applications. It combines all existing base/plinth functions in a single solution, as well as opening up many new applications. As if that wasn't enough, it is also compatible with existing enclosure solutions VX, VX IT, VX SE, TX, PC, TopConsole and IW. In short, it is a base/plinth system.

The base/plinth system VX comprises the following components:

- Base/plinth corner pieces with base/plinth trim panels, front and rear
- Base/plinth trim panels, sides

Thanks to fully symmetrical corner pieces, and by using the same base/plinth trim panels in the width and depth, the system opens up many new applications. For example, the vented trim panels and trim panels with brush strips available as accessories may now optionally be attached at the sides, or exchanged for the front/rear trim panels.

All trim panels may optionally be clipped into the corner piece, or securely screw-fastened. Depending on the application, for example, users can dispense with the trim panels between bayed enclosure suites, or a 100 mm high trim panel may be used to stabilise the base/plinth corner pieces. In combination with its extensive range of accessories, and thanks to its compatibility with enclosure accessories, the base/plinth system VX offers almost infinite possibilities in terms of siting, transportation, cable routing, cable attachment and base/plinth configuration.



One Model No. for the **base/plinth corner pieces with base/plinth trim panels, front and rear**

One Model No. for the **base/plinth trim panels, sides**

One complete **base/plinth VX**

Base/plinth	Basic form	Cable entry options				Stabilisation of bayed base/plinths
100 mm						
200 mm						

Configuration examples

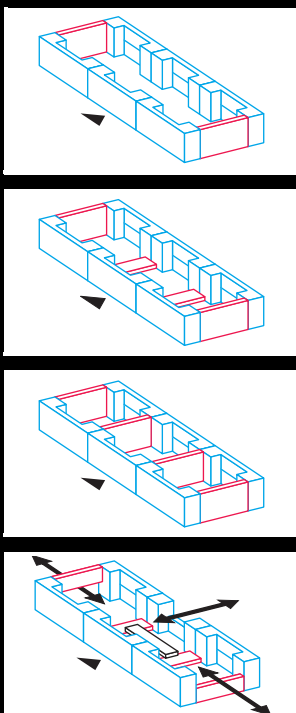

Order includes	Functional benefits
3 packs of Base/plinth corner pieces with base/plinth trim panels 1 pack of Base/plinth trim panels, sides, 200 mm high	Continuous cable chamber
3 packs of Base/plinth corner pieces with base/plinth trim panels 1 pack of Base/plinth trim panels, sides, 200 mm high 1 pack of Base/plinth trim panels, sides, 100 mm high 1 pack of with inlaying brackets (8617.500, packs of 6) 4 pieces are required for this solution	Additional stability during transportation with base/plinth trim panels rotated through 90°
3 packs of Base/plinth corner pieces with base/plinth trim panels 2 packs of Base/plinth trim panels, side, 200 mm high	Shielding of the base/plinths from one another

Other options:

- Cable entry at the side by fitting a 100 mm base/plinth trim panel with brush strip
- Cable entry from the rear by dismantling one or more trim panels from the base/plinth corner pieces and replacing them with trim panels with brush strips
- Cable routing in the base/plinth by using punched sections with mounting flanges on the base/plinth trim panels

Base/plinth

Base/plinth system VX

Base/plinth corner pieces with base/plinth trim panels, front and rear

Sheet steel

High-load capacity base/plinth corner pieces with moulded self-positioning to the enclosure, may be used with or without trim panels depending on the application. Large openings in the base/plinth corner piece for optimum access to the screw-fastening point, may be concealed with a plastic corner and baying cover.

Material:

- Base/plinth corner piece: Sheet steel
- Base/plinth trim panel front/rear: Sheet steel
- Corner and baying cover: Plastic

Colour:

- RAL 9005

100 mm high supply includes:

- 4 base/plinth corner pieces, 100 mm high
- 4 corner covers
- 1 baying cover
- 2 base/plinth trim panels, front/rear, 100 mm high
- Assembly parts

200 mm high supply includes:

- 4 base/plinth corner pieces, 200 mm high
- 4 corner covers
- 1 baying cover
- 1 base/plinth trim panel, front/rear, 200 mm high
- 2 base/plinth trim panels, front/rear, 100 mm high
- Assembly parts

100 mm high

For enclosure width mm	Model No.
300	8640.000
400	8640.001
600	8640.002
800	8640.003
850	8640.004
1000	8640.005
1100	8640.006
1200	8640.007
1600	8640.008
1800	8640.009

200 mm high

For enclosure width mm	Model No.
300	8640.020
400	8640.021
600	8640.022
800	8640.023
1000	8640.024
1200	8640.025
1600	8640.026
1800	8640.027



Also required:

- Base/plinth trim panels, sides, to finish off a unit, for additional stabilisation between base/plinths, or for interior configuration, see page 90



Accessories:

- Base/plinth trim panels with brush strip, see page 90
- Base/plinth trim panels, vented, see page 91
- Base/plinth installation bracket, see page 93
- Levelling component for base/plinth, see page 93
- Base mounting plate, see page 92
- Base/plinth adaptor for twin castors and levelling feet, see page 97
- Baying bracket, internal, see page 112
- Transport castors for base/plinth VX, see page 92
- C rail 30/15, see page 167

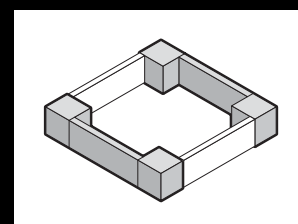

Base/plinth

Base/plinth system VX

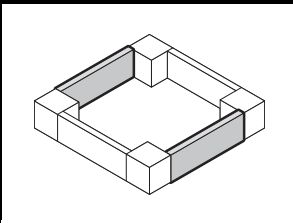
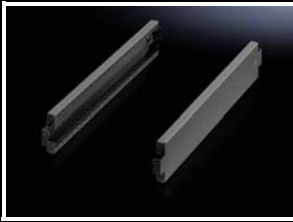

Base/plinth trim panels, sides

Sheet steel

To finish off a base/plinth unit at the sides and for additional stability or interior configuration of bayed base/plinths. One 200 mm high or two 100 mm high trim panels may optionally be fitted on 200 mm high base/plinths.

Material:

- Sheet steel

Colour:

- RAL 9005

Supply includes:

- 2 base/plinth trim panels
- Assembly parts

100 mm high

For enclosure depth mm	Model No.
300	8640.030
400	8640.031
500	8640.032
600	8640.033
800	8640.034
1000	8640.035
1200	8640.036

200 mm high

For enclosure depth mm	Model No.
300	8640.040
400	8640.041
500	8640.042
600	8640.043
800	8640.044
1000	8640.045
1200	8640.046



Accessories:

- Base/plinth installation bracket, see page 93



Possible alternative:

- Base/plinth trim panels with brush strip, see page 90
- Base/plinth trim panels, vented, see page 91

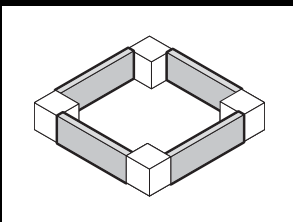

Base/plinth trim panels with brush strip

Sheet steel

For cable entry in the base/plinth. With a base/plinth height of 200 mm, one or two trim panels with brush strips may optionally be used. Thanks to the complete symmetry of the base/plinth system VX, the trim panels with brush strip may either be fitted at the front, rear or side on the base/plinth corner piece.

Material:

- Base/plinth trim panels: Sheet steel
- Brush strip: Plastic, self-extinguishing

Colour:

- RAL 9005

Supply includes:

- 2 base/plinth trim panels with brush strip
- Assembly parts

For enclosure width/depth mm	Model No.
600	8620.092
800	8620.093
1000	8620.094
1200	8620.095

Base/plinth

Base/plinth system VX

Base/plinth trim panels, vented

Sheet steel

For venting the enclosure via the base/plinth. Specifically in applications such as power distribution where the enclosure gland plates are not used, this can be used to achieve a higher air throughput inside the enclosure. Various solutions to raise the roof and special roof plates with vent openings are also available for enclosure venting. With a 200 mm base/plinth height, one or two vented trim panels may optionally be used. Thanks to the complete symmetry of the base/plinth system VX, the vented trim panels may either be fitted at the front, rear or side on the base/plinth corner piece.

Material:

- Sheet steel

Colour:

- RAL 9005

Supply includes:

- 2 base/plinth trim panels, vented
- Assembly parts for mounting on the base/plinth corner piece

For enclosure width/depth mm	Model No.
600	8620.090
800	8620.091

+ Accessories:

- Base/plinth installation bracket, see page 93
- Spacers for lifting the roof, see page 145
- Roof plate with vent holes, see page 146

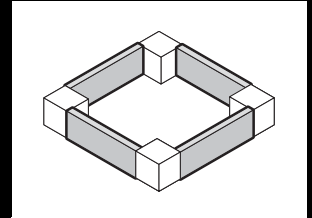

Base/plinth corner pieces with base/plinth trim panels, front and rear

Stainless steel

High-load capacity base/plinth corner pieces with moulded self-positioning to the enclosure, may be used with or without trim panels depending on the application. Large openings in the base/plinth corner piece for optimum access to the screw-fastening point, may be concealed with a plastic corner and baying cover.

Material:

- Base/plinth corner piece: Stainless steel 1.4301 (AISI 304)
- Base/plinth trim panel front/rear: Stainless steel 1.4301 (AISI 304 steel)
- Corner and baying cover: Plastic

Surface finish

- Trim panel: Grain size 400

100 mm high supply includes:

- 4 base/plinth corner pieces, 100 mm high
- 4 corner covers
- 1 baying cover
- 2 base/plinth trim panels, front/rear, 100 mm high
- Assembly parts

200 mm high supply includes:

- 4 base/plinth corner pieces, 200 mm high
- 4 corner covers
- 1 baying cover
- 1 base/plinth trim panel, front/rear, 200 mm high
- 2 base/plinth trim panels, front/rear, 100 mm high
- Assembly parts

For enclosure width mm	Height mm	Model No.
600	100	8620.050
800	100	8620.051
1000	100	8620.052
1200	100	8620.053
600	200	8620.060
800	200	8620.061
1000	200	8620.062
1200	200	8620.063

! Also required:

- Base/plinth trim panels, sides, to finish off a unit, for additional stabilisation between base/plinths, or for interior configuration, see page 92

+ Accessories:

- Base/plinth installation bracket, see page 93
- Levelling component for base/plinth, see page 93
- Base mounting plate, see page 92
- Base/plinth adaptor for twin castors and levelling feet, see page 97
- Transport castors for base/plinth, see page 92
- C rail 30/15, see page 167

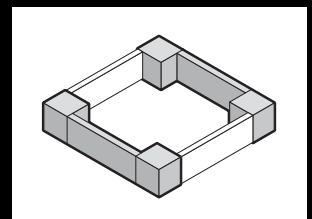

Base/plinth

Base/plinth system VX

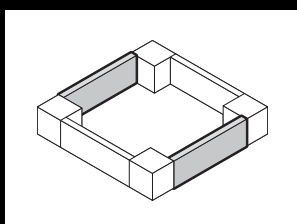

Base/plinth trim panel, sides

Stainless steel

To finish off a base/plinth unit at the sides and for additional stability or interior configuration of bayed base/plinths. One 200 mm high or two 100 mm high trim panels may optionally be fitted on 200 mm high base/plinths.

Material:

- Stainless steel 1.4301 (AISI 304)

Surface finish:

- Brushed, grain size 400

Supply includes:

- 2 base/plinth trim panels
- Assembly parts

For enclosure depth mm	Height mm	Model No.
400	100	8620.070
500	100	8620.071
600	100	8620.072
400	200	8620.080
500	200	8620.081
600	200	8620.082



Accessories:

- Base/plinth installation bracket, see page 93

Transport castors

For locating onto the base/plinth corner piece, 100 or 200 mm high.

Load capacity:

- Maximum permissible load per twin castor: 1000 N

Colour:

- RAL 9005

Supply includes:

- 4 twin castors, 2 x with, 2 x without locks

Floor clearance mm	Model No.
100	8100.700



Accessories:

- Base/plinth trim panels, sides, for stabilisation, see page 90

Base mounting plate

For attaching the base/plinth to the floor. For assembly screws up to 12 mm Ø.

Material:

- Sheet steel

Surface finish:

- Zinc-plated

Packs of	Model No.
10 pc(s).	2817.000

Base/plinth

Base/plinth system VX

Base/plinth installation bracket

For configuring the base/plinth with punched sections with mounting flanges or cable clamp rails.
To fit 100 and 200 mm high base/plinth trim panels in sheet steel and stainless steel.

Material:

- Stainless steel 1.4301 (AISI 304)

Supply includes:

- 2 installation brackets
- 2 mounting brackets for cable clamp rail
- Assembly parts

Note:

- For interior installation on upright base/plinth trim panels
- For base/plinth trim panels rotated through 90°, the installation bracket is not needed, because in this position, the system punchings of the base/plinth trim panels may be used directly.

- 1 Installation bracket with mounting bracket for cable clamp rail
- 2 Cable clamp rail
- 3 Installation bracket
- 4 Punched section with mounting flange, 23 x 89 mm
- 5 Base/plinth trim panel, rotated through 90°

For base/plinth trim panel height mm	Packs of	Model No.
100	2 pc(s).	8620.400
200	2 pc(s).	



Accessories:

- Punched section with mounting flange, 23 x 64 mm, see page 164
- Punched section with mounting flange, 23 x 89 mm, see page 165
- Cable clamp rail, see page 204

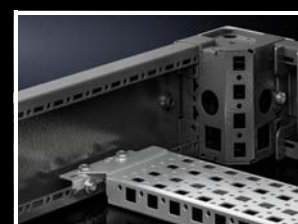
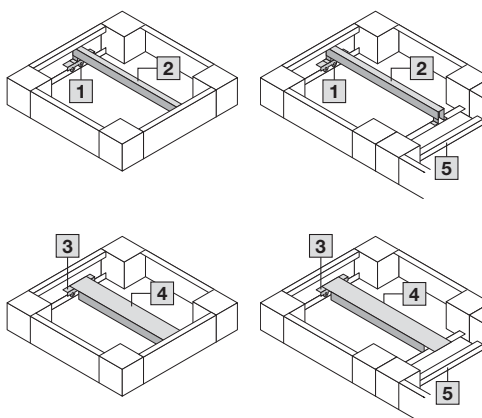

Levelling component

For retrospective levelling on uneven floors at the installation site up to a maximum of 15 mm.
Installed through the base/plinth corner piece.
Adjusted using a hex spanner, width across flats 19 mm.

Benefits:

- A door offset caused by uneven flooring can be corrected
- Installed on the assembled enclosure, i.e. no need to plan levelling in advance

Load capacity:

- Max. admissible load: 2500 N per levelling component (check the load capacity of the floor)

Supply includes:

- Assembly parts

For base/plinth height mm	Packs of	Model No.
100	4 pc(s).	8100.710
200	4 pc(s).	8100.711



Base/plinth

Base/plinth system VX



Cross member

adjustable

- To increase stability
- Height 70 mm
- Adjustable to the enclosure depth

To increase stability, the cross member is positioned below the base frame of the enclosure and protrudes 138 mm at the front and rear. For deeper enclosures, the rear part may be extended and screw-fastened again. For screw-fastening to the floor and enclosure with mounting hole at the sides, front and rear. The castors and levelling feet may be secured to the welded nuts M12.

Material:

- Sheet steel

Surface finish:

- Spray-finished

Colour:

- RAL 7015

For enclosure depth mm	Model No.
400	8601.450
500	
600	8601.680
800	

+ Accessories:

- Twin castors 6148.000, 7495.000, see page 96
- Levelling feet 4612.000, see page 96

Assembly

- Ensure sufficient stability to prevent the enclosure from tipping over

Filter mat

for base/plinth trim panel, vented

The filter mat is simply inserted into the trim panel from the rear.

Supply includes:

- 1 pack = 2 rolls, length 2 m each, may be shortened to required length

Packs of	Model No.
1 pc(s).	8620.100

Baying cover

To neatly close the gap between two bayed base/plinths and it is required to close the gap at the rear when baying three or more base/plinths.

Material:

- Plastic ABS, halogen-free

Colour:

- RAL 9005

Note:

- A baying cover is already included as standard with the supply of base/plinth corner pieces with base/plinth trim panels, front and rear.

Height mm	Packs of	Model No.
100	10 pc(s).	8620.010
200	10 pc(s).	8620.011

Base/plinth

Base/plinth system VX

Cable chamber

With integral system punchings for individual system accessories.

Height: 200 mm

Material:

- Sheet steel

Colour:

- RAL 7035

Supply includes:

- 1 frame
- 2 trim panels front/rear
- Assembly parts for mounting on the enclosure

For enclosures		Packs of	Model No.
Width mm	Depth mm		
400	500	1 pc(s).	8600.455
400	600	1 pc(s).	8600.465
600	500	1 pc(s).	8600.655
600	600	1 pc(s).	8600.665
800	500	1 pc(s).	8600.855
800	600	1 pc(s).	8600.865
1200	500	1 pc(s).	8600.255
1200	600	1 pc(s).	8600.265



Accessories:

- Side panels for cable chamber, see page 95



Side panel for cable chamber

Height: 200 mm

Material:

- Sheet steel

Colour:

- RAL 7035

Supply includes:

- 2 side panels
- Assembly parts

For enclosure depth mm	Packs of	Model No.
500	2 pc(s).	8600.510
600	2 pc(s).	8600.520



Paint

For touching up and repairing powder-coated and wet-painted surfaces, air-drying.

	Colour	Model No.
Spray can 150 ml	RAL 9005	2440.905



Base



Levelling feet

To compensate for height differences with floor irregularities. Mounting thread M12.

Load capacity:

- Max. admissible load: approx. 3000 N per levelling foot

Material	Levelling range mm	Packs of	Model No.
Sheet steel	18 – 43	4 pc(s).	4612.000
Stainless steel	30 – 110	4 pc(s).	8100.780



Also required:

- For mounting on the base/plinth: Base/plinth adaptor, see page 97



Levelling feet

85 – 115 mm high

For mounting on enclosures, for easier floor cleaning and to compensate for floor irregularities ±15 mm.

Load capacity:

- Max. admissible load: 3,500 N per levelling foot

Material:

- Stainless steel 1.4301 (AISI 304)

Supply includes:

- Assembly parts

Packs of	Model No.
4 pc(s).	2859.000



Twin castors

For mobile use, for mounting directly on the enclosure. Mounting thread M12 x 20.

Supply includes:

- Packs of 4 twin castors, 2 x with, 2 x without locks
- Assembly parts

	Maximum admissible load (per castor)	750 N
	Floor clearance	85 mm
1	Lock	2 with, 2 without
	Packs of	4 pc(s).
	Colour	Black with grey running surface
	Model No.	6148.000



	Maximum admissible load (per castor)	1200 N
	Floor clearance	125 mm
2	Lock	2 with, 2 without
	Packs of	4 pc(s).
	Colour	Black
	Model No.	7495.000



Also required:

- For mounting on the base/plinth: Base/plinth adaptor, see page 97

Base/plinth adaptor

for twin castors and levelling feet

For mounting twin castors and levelling feet to the base/plinth.

Material	Packs of	Model No.
Sheet steel	4 pc(s).	8100.770
Stainless steel	4 pc(s).	8100.771



Also required:

- When fitting twin castors, side trim panels, see page 90, are required.

Note:

- Combined with twin castors, the admissible overall weight load is 3000 N



System divider

Divides the enclosure width into two zones. For example, this allows mounting plates, cable clamp rails or swing frames from 600 mm wide enclosures to be fitted in 1200 mm wide enclosures.

Material:

- Sheet steel

Surface finish:

- Zinc-plated

Supply includes:

- Assembly parts

Depth	Packs of	Model No.
600	2 pc(s).	8620.901



Accessories:

- Swing frame mounting kit, see page 210
- Cable clamp rail, see page 204
- Support rails 48 x 26 mm, see page 167



Base

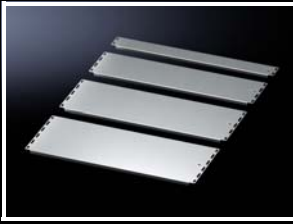

Gland plates

For individual configuration of the floor space. Potential equalisation is provided via assembly components and earthing points.

Material:

- Sheet steel

Surface finish:

- Zinc-plated

Supply includes:

- Assembly parts

Note:

- At least one sliding plate is required to fully seal a base opening.
- For two-door enclosures, one pack is sufficient for one half of the enclosure

Example with enclosure depth 600 mm

T1 (600 mm) - 148 = T2 (452 mm)

- 1 Sliding plate

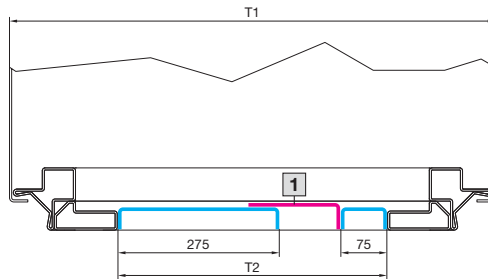

+ Accessories:

- Sliding plate, see page 98

For enclosure width 600 mm

Depth mm	Packs of	Model No.
75	1 pc(s).	8001.210
175	1 pc(s).	8001.214
237.5	1 pc(s).	8001.218
275	1 pc(s).	8001.222

For enclosure width 800 mm

Depth mm	Packs of	Model No.
75	1 pc(s).	8001.211
175	1 pc(s).	8001.215
237.5	1 pc(s).	8001.219
275	1 pc(s).	8001.223

For enclosure width 1000 mm

Depth mm	Packs of	Model No.
75	1 pc(s).	8001.212
175	1 pc(s).	8001.216
237.5	1 pc(s).	8001.220
275	1 pc(s).	8001.224

For enclosure width 1200 mm

Depth mm	Packs of	Model No.
75	1 pc(s).	8001.213
175	1 pc(s).	8001.217
237.5	1 pc(s).	8001.221
275	1 pc(s).	8001.225



Sliding plate

For variable compensation as well as a flexible opening in the base area. May be combined with gland plates.

Gland plate depth:

- 65 - 115 mm

Material:

- Sheet steel

Surface finish:

- Zinc-plated

Supply includes:

- Assembly parts

For enclosure width mm	Packs of	Model No.
600	1 pc(s).	8001.239
800	1 pc(s).	8001.241
1000	1 pc(s).	8001.242
1200	1 pc(s).	8001.243

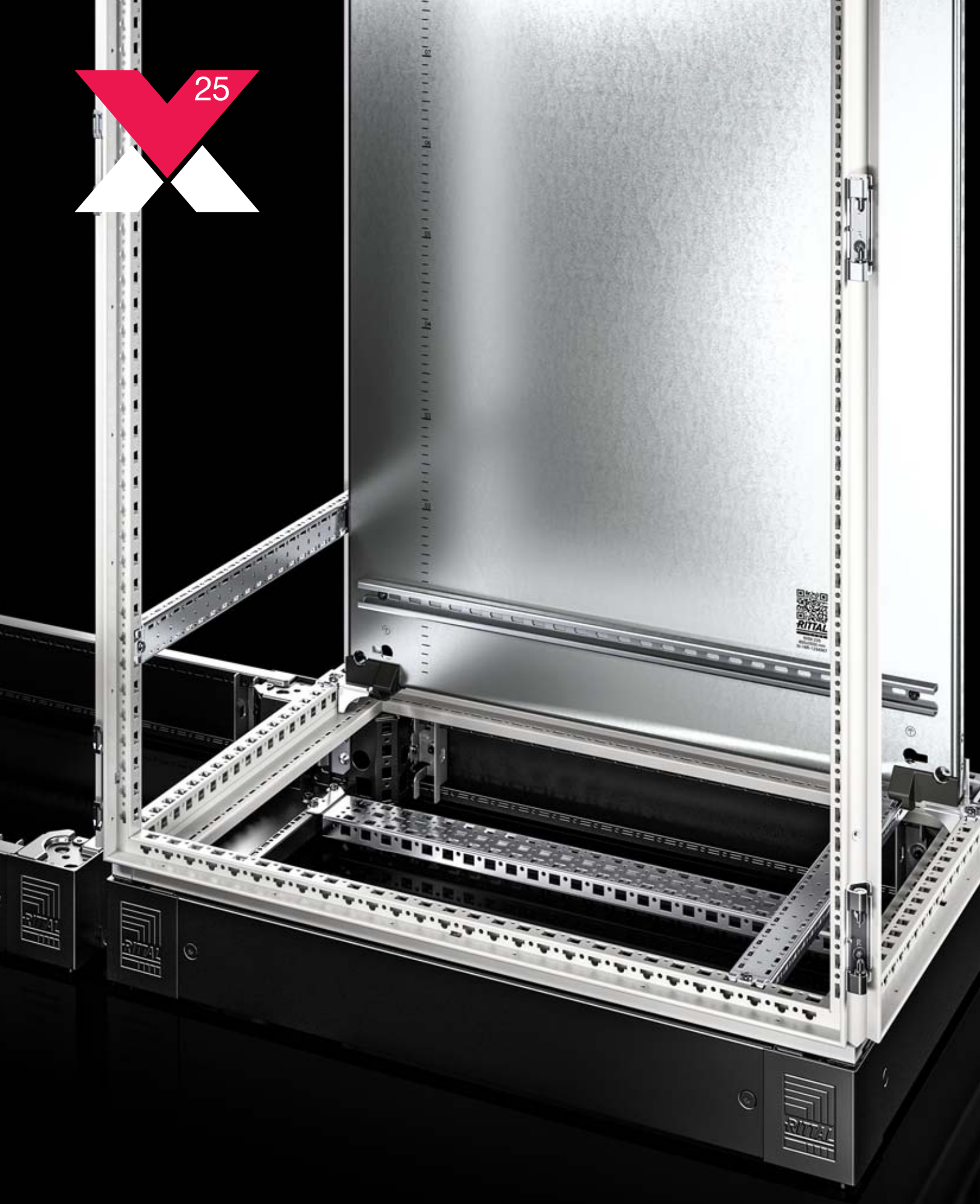



Side panels
Simple one-man installation with the positioning aid provided as standard.

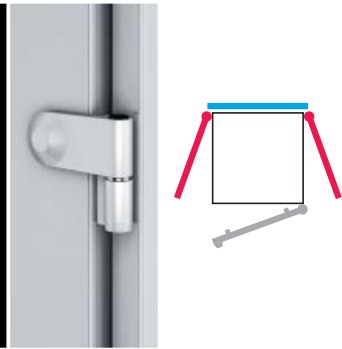

Hinge
The hinge for side panels provides unhindered access from the side at any time, so the side panel can be opened at an angle of 180°.

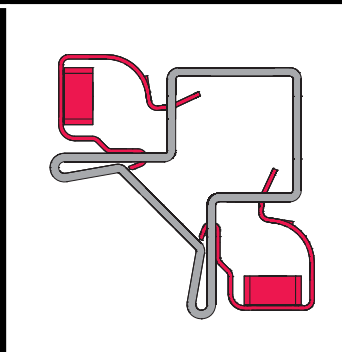

Side panel holder
The side panel holders are easily retro-fitted and removed at any time because they simply clip into position from the outside, even with the rear panel fitted. Internal earthing inserts ensure automatic potential equalisation, while at the same time guaranteeing enhanced EMC protection.

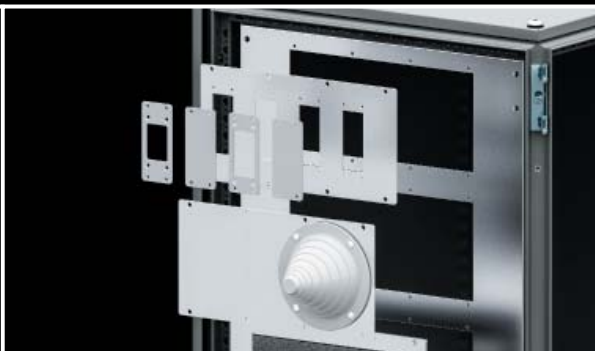

Divider panel for module plates
A complete system comprised of a divider panel, module plates and adaptors, and even a cover with a door, is available for mounting heavy connectors. It goes without saying that the door can also be integrated into the complete lock system, with all its variants.



Right

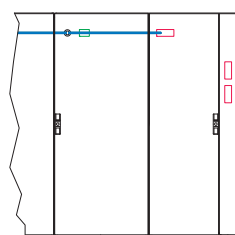

Left

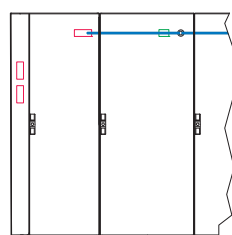

Isolator door cover
The solution for all switchgear subject to the requirements of UL 508 A for bayed enclosure suites. The Isolator door cover can be used on the left or right, and is finished off with the standard side panel.

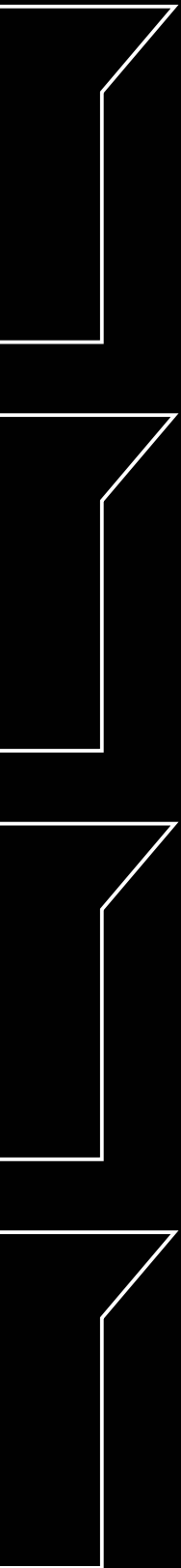

Walls

Side panels



Side panel, screw-fastened, sheet steel

- Time-saving assembly thanks to clip-in side panel holders
- Automatic potential equalisation and higher EMC protection, thanks to enclosure panel holders with earthing inserts located on the inside
- Easy positioning in the height and depth with the location aid
- One-person assembly
- Earthing bolts with large, paint-free contact surface for optimum contact

Material:

- Sheet steel, 1.5 mm

Surface finish:

- Dipcoat-primed, powder-coated on the outside

Colour:

- RAL 7035

Protection category IP to IEC 60 529:

- IP55 (in conjunction with enclosures from the VX series)

Supply includes:

- Assembly parts

For enclosures		Packs of	Model No.
Height mm	Depth mm		
1200	500	2 pc(s).	8115.245
1400	500	2 pc(s).	8145.245
1600	500	2 pc(s).	8165.245
1600	600	2 pc(s).	8166.245
1600	800	2 pc(s).	8168.245
1800	400	2 pc(s).	8184.245
1800	500	2 pc(s).	8185.245
1800	600	2 pc(s).	8186.245
2000	400	2 pc(s).	8104.245
2000	500	2 pc(s).	8105.245
2000	600	2 pc(s).	8106.245
2000	800	2 pc(s).	8108.245
2200	600	2 pc(s).	8126.245
2200	800	2 pc(s).	8128.245



Accessories:

- Hinge for side panel, screw-fastened, sheet steel, see page 103



Side panel, screw-fastened, stainless steel

- Time-saving assembly thanks to clip-in side panel holders
- Automatic potential equalisation and higher EMC protection, thanks to enclosure panel holders with earthing inserts located on the inside
- Easy positioning in the height and depth with the location aid
- One-person assembly
- Earthing bolts with large, paint-free contact surface for optimum contact

Material:

- Stainless steel 1.4301 (AISI 304), 1.5 mm

Surface finish:

- Brushed, grain size 400

Protection category IP to IEC 60 529:

- IP55 (in conjunction with enclosures from the VX series)

Supply includes:

- Assembly parts

For enclosures		Packs of	Model No.
Height mm	Depth mm		
1800	400	2 pc(s).	8700.030
1800	500	2 pc(s).	8700.040
2000	600	2 pc(s).	8700.050

Hinge

for side panel, screw-fastened, sheet steel

The 180° opening angle allows unhindered access from the side.

Material:

- Die-cast zinc

Colour:

- RAL 7035

Protection category IP to IEC 60 529:

- IP55

Supply includes:

- Assembly parts

Packs of	Model No.
6 pc(s).	8106.260

Note:

- Hinge mounting (red) is only possible in the vicinity of the rear panel (blue)
- Only for use with a side panel depth of 800 mm or less

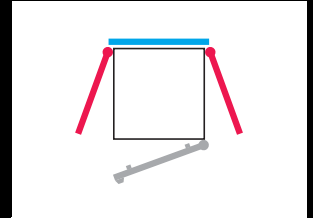

Walls

Divider panels/partitions

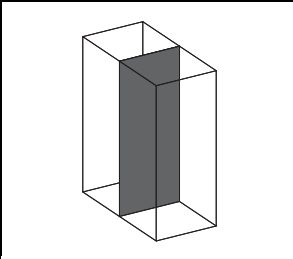

Divider panel

For shielding individual enclosure cells. Thanks to the symmetry of the frame system, the divider panel can also be used at the rear. All-round, double fold for stability and to hold the seal.

Material:

- Sheet steel, 1.5 mm

Surface finish:

- Zinc-plated

Protection category IP to IEC 60 529:

- IP54

Supply includes:

- Assembly parts



Also required:

- When buying in conjunction with a divider panel:
Baying bracket, internal 8617.500, see page 112
or baying connector, external 8617.502, see page 112



Accessories:

- Cover with door, see page 107

For enclosures		Model No.
Height mm	Depth mm	
1800	400	8609.200
1800	500	8609.201
1800	600	8609.202
2000	400	8609.203
2000	500	8609.204
2000	600	8609.205
2000	800	8609.206
2200	600	8609.207

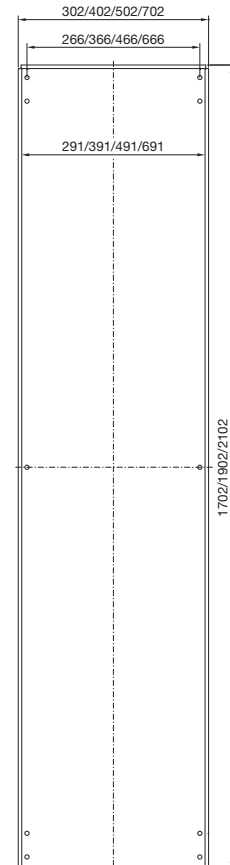

Divider panels/partitions

Divider panel

for module plates

With cut-outs for the installation of module plates for connectors or for cable entry, and also for the entry of busbar systems and other installed equipment. All-round, double fold for stability and to hold the seal. The symmetry of the enclosure frame means that divider panels may also be fitted at the rear, dimensions permitting.

Material:

- Sheet steel, 2 mm

Surface finish:

- Zinc-plated

Supply includes:

- Assembly parts



Also required:

- When buying in conjunction with a divider panel:
Baying bracket, internal 8617.500, see page 112
or baying connector, external 8617.502,
see page 112



Accessories:

- Module plates, see page 106
- Cover with door, see page 107
- Baying bracket, internal, see page 112

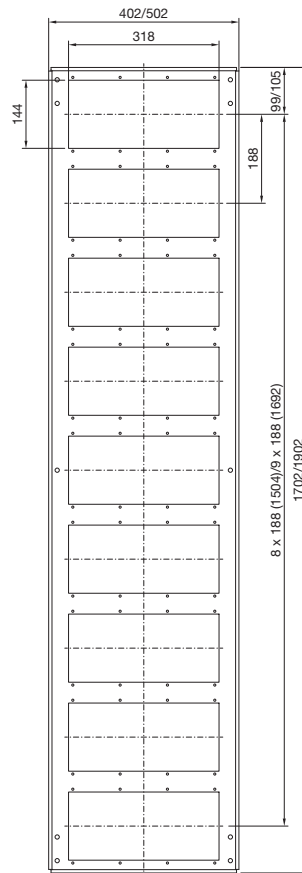

For enclosures		Number of cut-outs	Model No.
Height mm	Depth mm		
1800	500	9	8609.210
1800	600	9	8609.211
2000	500	10	8609.212
2000	600	10	8609.213

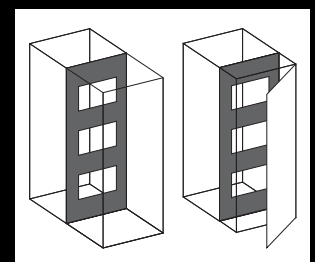
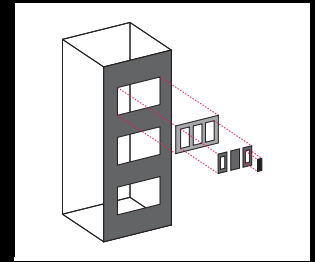

Walls

Divider panels/partitions

Module plates

Material:

- Sheet steel, 2 mm

Surface finish:

- Zinc-plated

Supply includes:

- Including seal

Design	Cut-outs	Packs of	Model No.
Solid	-	1 pc(s).	8609.160
For 16-pole connectors	4	1 pc(s).	8609.150
For 24-pole connectors	4	1 pc(s).	8609.140
For cable entry	1	1 pc(s).	8609.170
With cable sleeve	1	1 pc(s).	8609.390



Solid

For sealing unused cut-outs.
Easily machined for individual cut-outs.



For 16/24-pole connectors

With cut-outs to accommodate connectors.



Accessories:

- Adaptor, cover plate, see page 107
- Connector gland for connector cut-outs, see page 107
- Sealing frame, modular, see page 201



For cable entry

For inserting pre-assembled cables. Sealed, secure routing is achieved via adjustable angle brackets with inserted foam cable clamp strip. Fixed bracket, punched, for cable clamping.



Accessories:

- Cable tie for fast assembly 2597.000, see page 205



With cable sleeve

For cable diameters from 10 to 65 mm. The flexible grommet adapts to the cable's bending radius

Divider panels/partitions

Adaptor

for connector cut-outs

For using connectors with varying numbers of poles.

Material:

– Sheet steel

Surface finish:

– Zinc-plated

Supply includes:

– Seal and assembly parts

For reduction	Packs of	Model No.
From 24 to 16 poles	5 pc(s).	2479.000
From 24 to 10 poles	5 pc(s).	2480.000
From 24 to 6 poles	5 pc(s).	2481.000
From 16 to 10 poles	5 pc(s).	2401.000
From 16 to 6 poles	5 pc(s).	2402.000



Cover plate

for connector cut-outs

For unused cut-outs.

Material:

– Sheet steel

Surface finish:

– Zinc-plated

Supply includes:

– Seal and assembly parts

For	Packs of	Model No.
24-pole cut-outs	20 pc(s).	2477.000
16-pole cut-outs	20 pc(s).	2478.000



Connector gland

for connector cut-outs (24-pole)

For inserting 2 pre-assembled cables through the connector cut-out, without dismantling the cable connector.

Cable diameters : 8 – 36 mm

Material:

– Enclosure: Plastic
– Clamp terminal plate: Sheet steel

Surface finish:

– Clamps: Zinc-plated

Supply includes:

– Assembly parts

Packs of	Model No.
1 pc(s).	2400.000

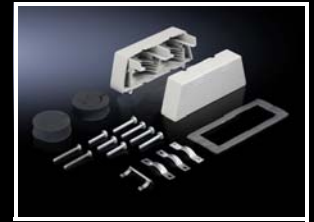

Cover with door

– To protect and finish off connectors or other installed equipment.
– Optional cable entry from above or below

Material:

– Cover with door: Sheet steel, 1.5 mm
– Door: Sheet steel, 2.0 mm

Surface finish:

– Spray-finished

Colour:

– RAL 7035

Protection category IP to IEC 60 529:

– IP55

Protection category to NEMA:

– NEMA 12

Supply includes:

– Cover
– Door with locking rod and double-bit lock insert
– 2 trim panels for top and bottom

For enclosures		Model No.
Height mm	Depth mm	
2000	500	8609.220
2000	600	8609.230

Accessories:

– Lock inserts, type G, see page 129
– Comfort handle, see page 128
– 180° hinge, see page 119



Walls

Isolator door locking



Isolator door cover

Including main door latch for safety locking of enclosures and bayed enclosure suites in accordance with UL regulations. Tested in conjunction with actuator lever for master switch from the following companies:

- Allen Bradley
- Square D
- General Electric
- Eaton
- Siemens

A detailed overview of types can be found on the Internet, together with the product description.

Benefits:

- Meets the requirements of UL 508 A
- In conjunction with the operating mechanism, adjacent door lock and interconnecting rods, these requirements are also met for bayed combinations
- Optional mounting on the left or right of the enclosure. With this cover, all single-door bayed enclosures may be configured as isolator door enclosures. The complete installation surface of the enclosure is retained.
- In conjunction with the integrated mounting plate infill, the mounting surface of the main enclosure can be enlarged by up to 14%.
- Two cut-outs for actuator levers on the front, for internal mounting at varying heights

Material:

- Sheet steel, 1.5 mm

Surface finish:

- Powder-coated

Colour:

- RAL 7035

Protection category IP to IEC 60 529:

- IP55

Protection category to NEMA:

- NEMA 12

Supply includes:

- Main door lock, cover plate and assembly parts

Note:

- Cover may only be mounted on a single-door enclosure with tubular door frame



Also required:

- Operating mechanism 4912.000, for enclosure with isolator door cover and additionally in every fourth adjacent enclosure, see page 109
- Adjacent door latch 4911.000, 4911.100, for every adjacent enclosure, see page 109
- Interconnecting rods, for every adjacent enclosure in the appropriate enclosure width, see page 109
- Side panel, screw-fastened, see page 102



Accessories:

- Mounting plate infill, see page 151

Isolator door locking

- 1 Operating mechanism
- 2 Adjacent door latch (single-door)
- 3 Interconnecting rod
- 4 Connection component
- 5 Main door latch
- 6 Adjacent door latch (two-door)
- 7 Side panel, screw-fastened

Installation to the right of the enclosure

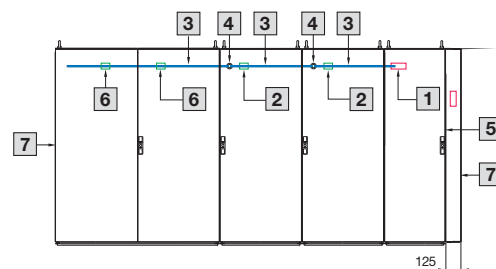

Width mm	Height mm	Depth mm	Material thickness mm	Surface finish	Colour	Model No.	
						Sheet steel	Stainless steel 1.4301 (AISI 304)
103	1800	400	1.5	Powder-coated	RAL 7035	8951.020	-
103	1800	400	1.5	Brushed, grain size 400	-	-	8952.020
103	1800	500	1.5	Powder-coated	RAL 7035	8951.030	-
103	1800	500	1.5	Brushed, grain size 400	-	-	8952.030
103	2000	500	1.5	Powder-coated	RAL 7035	8951.000	-
103	2000	600	1.5	Powder-coated	RAL 7035	8951.010	-
103	2000	600	1.5	Brushed, grain size 400	-	-	8952.010

Isolator door locking

Door latch for bayed enclosure suites

In conjunction with the isolator door cover, the requirements of UL 508 A are also met for bayed enclosure suites. Depending on the baying combination, different components will be required; refer to the assembly sketch on page 108.

Note:

- The door latch for bayed enclosure suites can also be used without the isolator door cover and in combination with commercially available master switches. In this way, adjacent doors cannot be opened until the main door has been opened.

- 1** Operating mechanism
Fitted in the enclosure with main switch and additionally in every fourth adjacent enclosure

	Packs of	Model No.
Operating mechanism	1 pc(s).	4912.000

- 2** Adjacent door latch
Installation in adjacent enclosure

Adjacent door latch for	Packs of	Model No.
Single-door enclosures	1 pc(s).	4911.000
Two-door enclosures	1 pc(s).	4911.100

- 3** Interconnecting rod
To extend locking from the main enclosure to the adjacent enclosures of a bayed suite. One interconnecting rod corresponding to the width of the enclosure is required for each adjacent enclosure.

For enclosure width mm	Packs of	Model No.
600	10 pc(s).	4916.000
800	10 pc(s).	4918.000
1200	10 pc(s).	4920.000

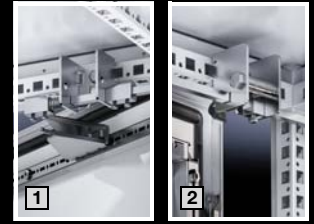

Baying system



Baying connector, external
Simple baying on the vertical sections, even retrospectively, if installed equipment makes it difficult or impossible to bay from the inside.



Baying block, internal
Flexible positioning at the baying point, flush with the enclosure section on a 25 mm pitch pattern. Top-mounting of the baying block is easily achieved. Enclosures are easily pushed together.



Baying cover, top
Reliably protects the baying point at the top to prevent the accumulation of dirt and liquids.



Baying seal
Fast, secure-fit, all-round attachment of the baying seal onto the section edge; easily removed at any time without leaving any residues. Lends itself readily to reuse.



Baying bracket, internal

For flexible positioning at the baying point on a 25 mm pitch pattern, thereby avoiding collisions with equipment installed across multiple enclosures. The option of screw-fastening the baying bracket from the side makes it easy to push enclosures together.

Combination angle

The combination angle can be exchanged for the roof mounting screw, to ensure optimum load distribution among the enclosure corner points when bayed enclosure suites are transported by crane.

Baying base/plinth corner pieces

The internal baying bracket can also be used for stable baying of base/plinth corner pieces in the base/plinth system VX.

Baying kit, VX25 to TS 8

Ensures the secure baying of a VX25 when extending existing TS 8 enclosure suites.



Baying system

Baying



Baying bracket, internal

- Fast, secure installation either from the front or from the side.
- For all-round installation on the baying point
- May be flexibly positioned to avoid collisions with installed equipment
- Also suitable for baying base/plinth components

Material:

- Sheet steel

Surface finish:

- Zinc-plated

Supply includes:

- Baying bracket, internal
- Baying seal
- Assembly parts

Packs of	Model No.
6 pc(s).	8617.500

Note:

- 1 pack is sufficient for one baying joint

Possible alternative:

- Baying block, internal, see page 112
- Baying connector, external 8617.502, see page 112

Baying block, internal

- Side mounting creates a flush surface to the extrusion, suitable for top mounting, thus avoiding collisions with installed equipment
- For all-round installation on the baying point

Material:

- Die-cast zinc

Supply includes:

- Baying block, internal
- Baying seal
- Assembly parts

Packs of	Model No.
6 pc(s).	8617.501

Note:

- 1 pack is sufficient for one baying joint

Possible alternative:

- Baying bracket, internal, see page 112
- Baying connector, external 8617.502, see page 112

Baying connector, external

For mounting on the vertical enclosure sections from the outside.

Supply includes:

- Baying connector, external
- Baying seal
- Assembly parts

Material	Packs of	Model No.
Sheet steel, zinc-plated	6 pc(s).	8617.502
Stainless steel 1.4301 (AISI 304)	6 pc(s).	8617.503

Note:

- 1 pack is sufficient for one baying joint

Possible alternative:

- Baying bracket, internal, see page 112
- Baying block, internal, see page 112

Baying system

Baying

Quick-fit baying clamps

- For all-round installation on the baying point
- May be flexibly positioned to avoid collisions with installed equipment
- Simply tighten the screws, tap in the quick-fit baying clamp, pull the enclosures together and secure
- Additional mounting level between bayed enclosures, e.g. for mounting cable ducts

Material:

- Sheet steel

Surface finish:

- Zinc-plated

Supply includes:

- Assembly parts

Packs of	Model No.
6 pc(s).	8617.506

Note:

- 1 pack is sufficient for one baying joint

**Accessories:**

- gasket-fit baying clamps 8617.507, see page 113

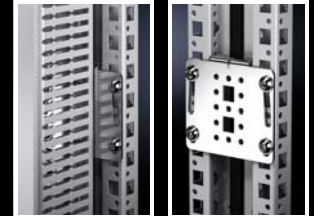

Angular baying bracket

For stable connection in the corners of bayed enclosures. Perfectly suited for aligning enclosures with one another on uneven floors.

Material:

- Sheet steel

Surface finish:

- Zinc-plated

Supply includes:

- Assembly parts

Packs of	Model No.
4 pc(s).	8617.508

Note:

- 1 pack is sufficient for one baying joint
- To achieve the required protection category and transportation stability, further baying connectors should be used halfway up the enclosure



Baying seal

May be used individually for baying on all existing enclosure sizes. The seal sits securely around the section edge, and is easily removed at any time without leaving any residues. It is also reusable.

Packs of	Model No.
1 pc(s).	8617.507

Material:

- EPDM

Supply includes:

- 8 m



Baying system

Baying



Combination angle

For optimum distribution of tensile forces during transportation of bayed enclosures by crane.

Supply includes:

- Assembly parts

Material	Packs of	Model No.
Sheet steel	4 pc(s).	4540.000
Stainless steel	2 pc(s).	4540.500

+ **Accessories:**

- Baying cover, top, see page 114



Baying cover, top

A cover with two end caps may additionally be clipped over the seal between the two enclosures. This prevents dirt and liquid from accumulating on the baying seal.

Supply includes:

- Assembly parts

Note:

- May also be fitted in the width with enclosure suites bayed back-to-back
- May also be used in conjunction with dust guard trim, see page 144

For enclosure depth mm	Packs of	Plastic RAL 7035	Stainless steel 1.4301 (AISI 304)	Model No.
400	1 pc(s).	■	-	8800.845
500	1 pc(s).	■	-	8800.855
600	1 pc(s).	■	-	8800.865
800	1 pc(s).	■	-	8800.885
400	1 pc(s).	-	■	8700.140
500	1 pc(s).	-	■	8700.150
600	1 pc(s).	-	■	8700.160

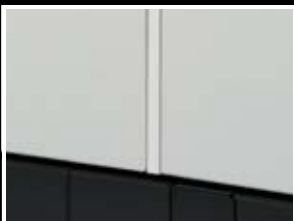

Baying cover, vertical

To balance out the gap between the side panels when baying back-to-back. For enclosure height 2200 mm, or may be cut to length individually for lower heights.

Material:

- Cover section: Plastic

Colour:

- RAL 7035

Supply includes:

- Assembly parts

Packs of	Model No.
2 pc(s).	8800.875

! **Also required:**

- Baying connector, external, 8617.502, see page 112



Baying kit, VX25 to TS 8

For extending existing TS 8 bayed enclosure suites with VX25 enclosures.

Material:

- Baying connector: Sheet steel

Supply includes:

- 8 baying connectors
- 1 seal
- Assembly parts

Packs of	Model No.
1 pc(s).	8617.505





Glazed door

The glazed door is an easy replacement for a sheet steel door, without the need for machining. The single-pane safety glass features a designer grid pattern print at the top and bottom. The glazed door is pre-fitted as standard with 180° hinges.

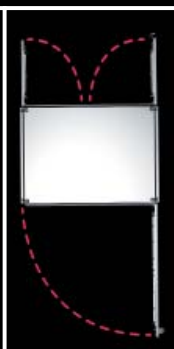
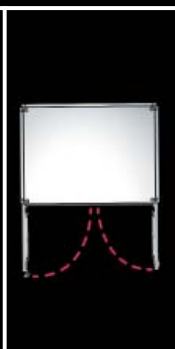

Lockable and adjacent door

In 800 mm wide enclosures, the one-piece standard door may be replaced for a two-piece lockable and adjacent door, so that mandatory escape routes can still be observed in confined spaces. The lockable and adjacent door may also be fitted instead of the rear panel.



Protective bar

In open control systems, the protective bar prevents people from falling into the switchgear. In combination with the hinged trim panel, top, this allows the safe accommodation of display and control components despite the open switchgear.



Modular climate control concept

The modular climate control concept allows cooling unit components up to 2500 W to be integrated into the enclosure door, without the need for machining. The standard door is easily replaced for the modular climate control door. In two-door enclosures, either the lockable door or the adjacent door may be exchanged for a modular climate control door.



Partial doors

Partial doors allow individual configuration of the enclosure front. Sheet steel variants and variants with a viewing window are available.



Transport and mounting handle

The transport and mounting handle is an ergonomic tool to make the fitting and removal of doors easier. It is simply suspended from the tubular door frame.



Doors/locks

Door variants



Glazed door

Instead of a sheet steel door or rear panel.

Material:

- Frame: Extruded aluminium section
- Viewing window: Single-pane safety glass, 3 mm

Surface finish:

- Powder-coated

Colour:

- Frame and corner pieces: RAL 7035
- Viewing window (printed mask on the inside): RAL 9005

Protection category IP to IEC 60 529:

- IP55

Supply includes:

- Glazed door
- Locking rod with double-bit lock insert
- 180° hinges, 4 pc(s)

For enclosures		Model No.
Width mm	Height mm	
600	1800	8618.000
800	1800	8618.010
600	2000	8618.020
800	2000	8618.030
600	2200	8618.040
800	2200	8618.050



Also required:

- When mounting instead of the rear panel or double door: Lock components for frame 8618.110, see page 118



Accessories:

- Lock system, see page 128

Lock components

For retrofitting a glazed door or sheet steel door in place of a rear panel.

Material:

- Die-cast zinc

Supply includes:

- Assembly parts

Packs of	Model No.
4 pc(s).	8618.110

Lockable and adjacent door

For example, if two 400 mm doors are used instead of one 800 mm wide door in order to comply with escape routes. May also be fitted instead of an 800 mm wide rear panel.

Material:

- Sheet steel

Surface finish:

- Dipcoat-primed, powder-coated on the outside

Colour:

- RAL 7035

Protection category IP to IEC 60 529:

- IP55

Supply includes:

- 2 doors, including tubular door frame, hinges and lock components.

For enclosures		Model No.
Width mm	Height mm	
800	2000	8618.120



Accessories:

- Lock system, see page 128

Doors/locks

Door variants

Protective bar

As an alternative to a door, e.g. in sealed switch rooms. Prevents people from falling into the open enclosure frame. Easily removable for maintenance purposes. For 1200 mm enclosure width; may be shortened or divided for other sizes.

Material:

- Wood, spray-finished, RAL 3000

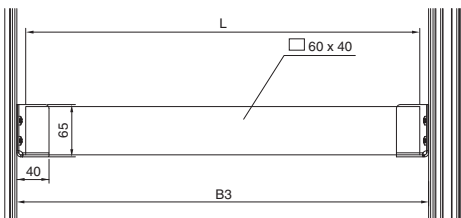

For enclosure width mm	Length mm	Packs of	Model No.
1200	1090	1 pc(s).	8801.010

Enclosure width mm	Clearance between the enclosure frame (B3) mm	Length of protective bar (L) mm
400	311	290 ¹⁾
600	511	490 ¹⁾
800	711	690 ¹⁾
1000	911	890 ¹⁾
1200	1111	1090

¹⁾ The protective bar 8801.010 (1090 mm) will need to be shortened



Also required:

- Holder 8801.000, see page 119



Holder

for protective bar

For mounting on the vertical section. The protective bar is simply inserted.

Material:

- Sheet steel

Surface finish:

- Zinc-plated

Supply includes:

- Assembly screws

Packs of	Model No.
2 pc(s).	8801.000



180° hinges

- For extending the door opening angle to 180°.
- May be mounted without machining the door
- Suitable for door installations up to 900 N

Supply includes:

- Assembly parts

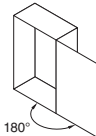
Material	Colour	Packs of	 Model No.
Steel/precision-cast	RAL 7035	4 pc(s).	8618.330
Steel/precision-cast	RAL 9005	4 pc(s).	8618.335
Stainless steel/precision-cast	-	4 pc(s).	8618.340



Modular climate control concept – Cooling module "Blue e"



VX25 enclosures Page 54 Base/plinth VX Page 89

All cooling modules may be individually combined with any climate control door. The cooling modules are equipped with energy-efficient Blue e technology, with integral e-Comfort controller, RiNano coating on the condenser and electric condensate evaporation as standard.

Benefits:

- May be linked to the IoT interface via the Blue e IoT adaptor

Temperature control:

- e-Comfort controller (factory setting +35 °C)

Material:

- Sheet steel

Colour:

- RAL 7035

Protection category IP to IEC 60 529:

- External circuit IP34
- Internal circuit IP54

Supply includes:

- Cooling module prepared for installation in climate control door
- Nano-coated condenser
- Integral electric condensate evaporation
- Fully wired ready for connection (plug-in terminal strip)

Note:

- A base/plinth with a height of 100 or 200 mm is required for efficient operation

Approvals:

Available on the Internet

Performance diagrams:

Available on the Internet

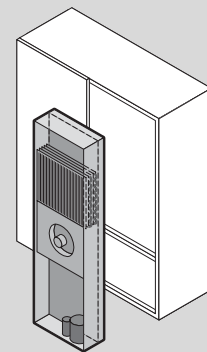

Output class 1500 – 2500 W

Model No.	Packs of	3307.700	3307.740	3310.700	3310.740	Page
Rated operating voltage V, ~, Hz		230, 1~, 50/60	400, 3~, 50 460, 3~, 60	230, 1~, 50/60	400, 3~, 50 460, 3~, 60	
Total cooling output 50/60 Hz L35 L35 kW		1.5 / 1.55	1.5 / 1.55	2.5 / 2.52	2.5 / 2.5	
Total cooling output 50/60 Hz L35 L50 kW		0.85 / 0.9	0.93 / 0.95	1.62 / 1.76	1.76 / 1.8	
Rated max. current A		6 / 6.1	2.5 / 2.7	7.6 / 9.4	3.5 / 3.7	
Start-up current A		22 / 24	8.5 / 9.2	22 / 24	13 / 14	
Power consumption P _{el} 50/60 Hz L35 L35 kW		0.85 / 1.05	0.79 / 1	1.31 / 1.52	1.13 / 1.48	
Operating temperature range		+10 °C...+55 °C	+10 °C...+55 °C	+10 °C...+55 °C	+10 °C...+55 °C	
Setting range		+20 °C...+55 °C	+20 °C...+55 °C	+20 °C...+55 °C	+20 °C...+55 °C	
Energy efficiency ratio (EER) 50/60 Hz L35 L35		1.76 / 1.48	1.9 / 1.55	1.91 / 1.66	2.21 / 1.69	
Refrigerant g		R134a, 700	R134a, 700	R134a, 1000	R134a, 1000	
Weight kg		68.0	68.0	73.0	72.0	

Also required

Modular climate control concept – climate control door VX25		see page	see page	see page	see page	121
---	--	----------	----------	----------	----------	-----

Accessories

IoT interface	1 pc(s).	3124.300	3124.300	3124.300	3124.300	Cat. 36, p. 554
Blue e IoT adaptor	1 pc(s).	3124.310	3124.310	3124.310	3124.310	Cat. 36, p. 555
Master-slave cable	1 pc(s).	3124.100	3124.100	3124.100	3124.100	Cat. 36, p. 550
Door-operated switch	1 pc(s).	4127.010	4127.010	4127.010	4127.010	178

Modular climate control concept – climate control door VX25

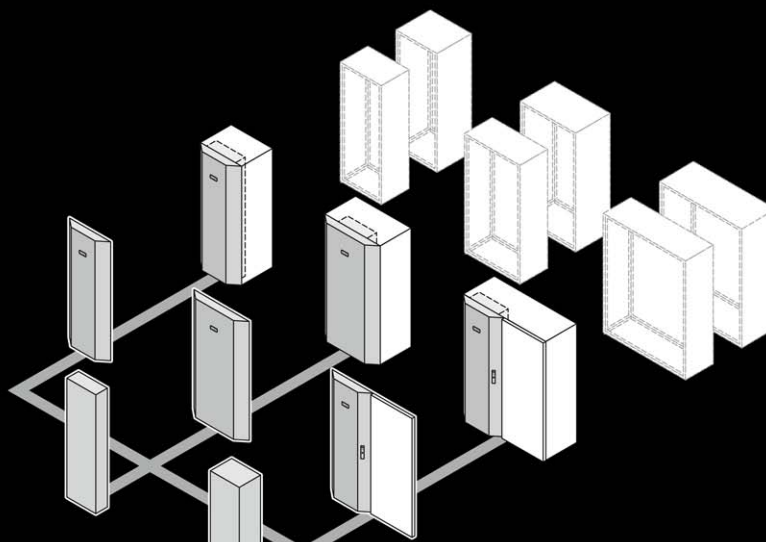

VX25 enclosures Page 54

Sheet steel climate control doors for the installation of climate control module types SK 3307.7XX to 3310.7XX. The climate control doors fit perfectly with the overall design of the enclosure.

Material:

- Sheet steel

Colour:

- RAL 7035

Supply includes:

- Climate control door without preconfigured cooling module
- 180° hinges, door opening angle approx. 130°

Note:

- To fit VX enclosures
- For 1200 mm wide VX enclosures, the existing hinged door may be used, irrespective of the device position (left or right)

Approvals:

Available on the Internet

For the installation of cooling modules

Model No.	Packs of	3201.800	3201.810	3201.820	3201.830	3201.840	3201.850	Page
Dimensions to fit enclosure type		VX	VX	VX	VX	VX	VX	
With height mm		1800	2000	1800	2000	1800	2000	
With width mm		600 1200	600 1200	800	800	600 1200	600 1200	
Unit positioned on the left		-	-	-	-	■	■	
Note on Model No.		R/h door hinge	R/h door hinge	R/h door hinge	R/h door hinge	L/h door hinge	L/h door hinge	
Weight kg		19.0	20.0	27.0	31.0	19.0	22.0	
Also required								
Modular climate control concept – Cooling module Blue e		see page	see page	see page	see page	see page	see page	120
Accessories								
Metal filter	1 pc(s).	3284.210	3284.210	3284.210	3284.210	3284.210	3284.210	Cat. 36, p. 534
Comfort handle VX	1 pc(s).	8618.250	8618.250	8618.250	8618.250	8618.250	8618.250	128
Ride-up roller	10 pc(s).	-	8618.420	-	8618.420	-	8618.420	136

Doors/locks

Installation accessories for modular front design

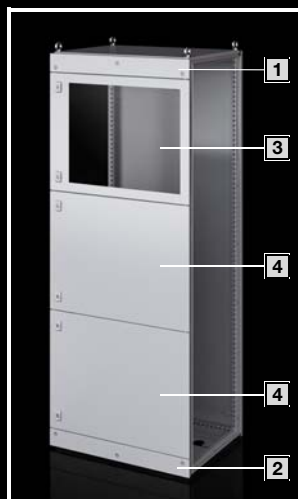

Modular front design

Suitable for 400 to 1200 mm wide enclosures instead of a door or rear panel. The partial doors with and without viewing panels, including cross members, may be combined with one another as required. A trim panel is required at the top and bottom in each case. The requirements for your individual front design and the considerations which must be taken into account are illustrated on the sample configuration opposite.

- 1 Front trim panel, top
- 2 Front trim panel, bottom
- 3 Partial door with viewing window
- 4 Partial door

Installation accessories for modular front design

Partial door

The door may be optionally hinged on the right or left. The partial door is attached to the enclosure with no drilling required. Standard double-bit lock insert may be exchanged for lock inserts, type A.

Material:

- Partial door: Sheet steel, 2 mm
- Viewing window: 3 mm single-pane safety glass

Surface finish:

- Textured paint

Colour:

- RAL 7035

Protection category IP to IEC 60 529:

- IP54 up to enclosure width 800 mm

Supply includes:

- Cross member, hinges and lock components
- Assembly parts

Note:

- Opening angle of partial doors max. 130°



Also required:

- Front trim panel, top, see page 124 or top-hinged trim panel, see page 125
- Front trim panel, bottom, see page 124



Accessories:

- Mini comfort handle (from AE enclosure height 380 mm, from AE enclosure width 200 mm)
- Lock inserts, type A, see page 123
- Perforated mounting strips, see page 124

For enclosure width 400 mm

Height mm	With viewing window	Number of locks	Packs of	Model No.
200	–	1	1 pc(s).	9682.142
300	–	1	1 pc(s).	9682.143
400	–	2	1 pc(s).	9682.144
600	–	2	1 pc(s).	9682.146
800	–	2	1 pc(s).	9682.148
1000	–	3	1 pc(s).	9682.140
1200	–	3	1 pc(s).	9682.152
1400	–	3	1 pc(s).	9682.154
1600	–	4	1 pc(s).	9682.156
1800	–	4	1 pc(s).	9682.158
2000	–	4	1 pc(s).	9682.150

For enclosure width 600 mm

Height mm	With viewing window	Number of locks	Packs of	Model No.
150	–	1	1 pc(s).	9682.161
200	–	1	1 pc(s).	9682.162
300	–	1	1 pc(s).	9682.163
400	–	2	1 pc(s).	9682.164
600	–	2	1 pc(s).	9682.166
600	■	2	1 pc(s).	9682.167
800	–	2	1 pc(s).	9682.168
800	■	2	1 pc(s).	9682.169
1000	–	3	1 pc(s).	9682.160
1200	–	3	1 pc(s).	9682.172
1400	–	3	1 pc(s).	9682.174
1600	–	4	1 pc(s).	9682.176
1800	–	4	1 pc(s).	9682.178
2000	–	4	1 pc(s).	9682.170

For enclosure width 800 mm

Height mm	With viewing window	Number of locks	Packs of	Model No.
150	–	1	1 pc(s).	9682.181
200	–	1	1 pc(s).	9682.182
300	–	1	1 pc(s).	9682.183
400	–	2	1 pc(s).	9682.184
600	–	2	1 pc(s).	9682.186
600	■	2	1 pc(s).	9682.187
800	–	2	1 pc(s).	9682.188
1000	–	3	1 pc(s).	9682.180
1200	–	3	1 pc(s).	9682.192
1400	–	3	1 pc(s).	9682.194
1600	–	4	1 pc(s).	9682.196
1800	–	4	1 pc(s).	9682.198
2000	–	4	1 pc(s).	9682.190

For enclosure width 1000 mm

Height mm	With viewing window	Number of locks	Packs of	Model No.
400	–	2	1 pc(s).	9682.104
600	–	2	1 pc(s).	9682.106
800	–	2	1 pc(s).	9682.108

For enclosure width 1200 mm

Height mm	With viewing window	Number of locks	Packs of	Model No.
400	–	2	1 pc(s).	9682.124
600	–	2	1 pc(s).	9682.126
800	–	2	1 pc(s).	9682.128



Doors/locks

Installation accessories for modular front design



Perforated mounting strips

for partial doors

For retrospective external mounting. The perforated mounting strips have a 25 mm pitch pattern of holes and may be used for mounting individual accessories such as cable ducts, hose holders etc. on the rear of the door.

Hole diameter of perforated mounting strip: 4.5 mm

Material:

- Sheet steel, 1 mm

Surface finish:

- Zinc-plated

Supply includes:

- Assembly parts

For enclosure width mm	Length mm	For partial door height mm	Packs of	Model No.
400	198	200 – 800	10 pc(s).	9681.204
600	398	150 – 800	10 pc(s).	9681.206
800	598	150 – 800	10 pc(s).	9681.208

Note:

- For enclosure width 1000 mm you will need: 1 x 9681.204 and 1 x 9681.206
- For enclosure width 1200 mm you will need: 2 x 9681.206



Front trim panels, top

To finish off the modular front design at the top when using partial doors. The front trim panels may be removed from the outside by unscrewing. The cross member required for mounting is included with the supply of the mounted partial door.

Material:

- Sheet steel, 1.5 mm

Surface finish:

- Textured paint

Colour:

- RAL 7035

Supply includes:

- Assembly parts

Solid, protection category IP54

For enclosure width mm	Height mm	Packs of	Model No.
400	100	1 pc(s).	9682.314
400	300	1 pc(s).	9682.324
600	100	1 pc(s).	9682.316
600	300	1 pc(s).	9682.326
800	100	1 pc(s).	9682.318
800	300	1 pc(s).	9682.328
1000	300	1 pc(s).	9682.320
1200	300	1 pc(s).	9682.322

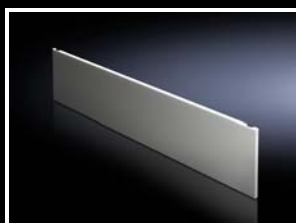

Front trim panels, bottom

To finish off the modular front design at the bottom when using partial doors. If version IP2X is chosen, a roof plate with protection category IP2X should be selected for top ventilation. The front trim panels may be removed from the outside by unscrewing.

Material:

- Sheet steel, 1.5 mm

Surface finish:

- Textured paint

Colour:

- RAL 7035

Supply includes:

- Front trim panel including cross member
- Assembly parts

Solid, protection category IP54

For enclosure width mm	Height mm	Packs of	Model No.
400	100	1 pc(s).	9682.334
400	300	1 pc(s).	9682.344
600	100	1 pc(s).	9682.336
600	300	1 pc(s).	9682.346
800	100	1 pc(s).	9682.338
800	300	1 pc(s).	9682.348
1000	100	1 pc(s).	9682.330
1000	300	1 pc(s).	9682.340
1200	100	1 pc(s).	9682.332
1200	300	1 pc(s).	9682.342

Vented, protection category IP2X

For enclosure width mm	Height mm	Packs of	Model No.
400	300	1 pc(s).	9682.354
600	300	1 pc(s).	9682.356
800	300	1 pc(s).	9682.358
1000	300	1 pc(s).	9682.350
1200	300	1 pc(s).	9682.352

Also required:

Roof plate IP2X, see page 146

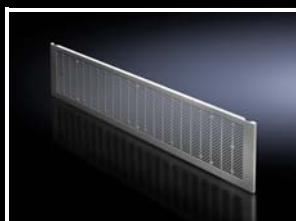

Installation accessories for modular front design

Trim panel, hinged at the top

For the installation of control and display components, in conjunction with

- Modular front design
- Protective bar

Material:

- Sheet steel, 2 mm

Surface finish:

- Textured paint

Colour:

- RAL 7035

Supply includes:

- Hinges, cam locks with double-bit insert and assembly parts

Width mm	Height mm	Packs of	Model No.
600	300	1 pc(s).	8620.500
800	300	1 pc(s).	8620.501
1200	300	1 pc(s).	8620.502



Accessories:

- Stay for trim panel, hinged at the top, see page 125
- Lock inserts, type A, see page 131



Drawer

For mouse and keyboard with a maximum width of 500/700 mm. A high level of protection is retained, even with the flap open.

Material:

- Sheet steel

Colour:

- RAL 7035

Supply includes:

- Flap and assembly parts
- Cross member

Height mm	Width mm	Model No.
200	600	8620.520
200	800	8620.521



Accessories:

- Lock inserts 27 mm, type A, see page 131



Support stay

for trim panel, hinged at the top

5 pitch pattern positions up to a maximum opening angle of approx. 85°.

Material:

- Sheet steel

Surface finish:

- Zinc-plated

Packs of	Model No.
2 pc(s).	8801.260





Electronic lock systems
When using electronic lock systems that require additional cabling, punchings are provided as standard in the door so that they can be fitted retrospectively without the need for machining.



Multiple lock
Up to six padlocks may be attached to the multiple lock, providing individual access rights for different individuals or groups of individuals.



Standard lock

The standard lock allows convenient, tool-free installation and removal. Simply unlatch the locking pin with the door opened. Replacing the lock insert or exchanging it for a comfort handle couldn't be simpler.

Comfort handle

Installation of the comfort handle is completely tool-free, and with its ingenious fold-down system, it does not require any swing space or door surface area. The comfort handle is available in all standard versions and lock inserts.

Seamless lock system

Because a full range of standard lock inserts is available for all the locks used, a seamless lock system can be created.







Doors/locks

Lock system



Comfort handle VX

As the handle does not take up any swing space, due to its folding action, the door surface area available for installed equipment is maximised. Simple assembly, thanks to the snap-mounted handle system. Prepared for the installation of lock inserts, lock and push-button inserts or for the installation of standard commercially available 40 or 45 mm profile half-cylinders.

					
	For lock inserts	For padlock and lock inserts	With security lock insert E1 ¹⁾	For profile half-cylinders	Prepared for ASSA lock system
	Model No.				
Die-cast zinc RAL 7035	8618.200	8618.230	8618.240	8618.250	8618.270
Precision-cast stainless steel	8618.220	-	-	8618.280	-
Lock inserts, type G					
7 mm square	8618.300	8618.300	-	-	-
8 mm square	8618.301	8618.301	-	-	-
7 mm triangular	8618.302	8618.302	-	-	-
8 mm triangular	8618.303	8618.303	-	-	-
Screwdriver	8618.304	8618.304	-	-	-
Daimler insert	8618.305	8618.305	-	-	-
3 mm double-bit	8618.306	8618.306	-	-	-
Fiat	8618.307	8618.307	-	-	-
6.5 mm triangular (CNOMO)	8618.308	8618.308	-	-	-
Lock and push-button inserts					
Lock insert, lock no. 3524 E ²⁾	8611.180	8611.180	-	2467.000	-
Push-button insert	8611.190	8611.190	-	2468.000	-
Push-button and lock insert ²⁾	8611.200 ³⁾	8611.200 ³⁾	-	2469.000 ⁴⁾	-
Profile half-cylinders					
to DIN 18 252 ⁵⁾	-	-	-	9785.040 ⁷⁾	-
	-	-	-	9785.042 ⁶⁾	-

¹⁾ Only for use with VW, Audi, SEAT, SkodaAuto, supplied without key

²⁾ With two keys

³⁾ Lock no. 12321; no other lock is possible

⁴⁾ Lock no. 2123; no other lock is possible

⁵⁾ With 3 keys for each lock insert

⁶⁾ Packs of two, simultaneous locking within the same pack, no simultaneous locking for different packs

⁷⁾ Different closures



Locking bar latch to CNOMO¹⁾

To fit all locking bars in doors and glazed doors with standard lock or comfort handle VX

The latch prevents the locking bars from moving when the door is open.

¹⁾ CNOMO is a French automobile industry standard. For safety reasons, it must not be possible to lock the handle whilst the door is open.



Packs of	Model No.
10 pc(s).	8618.460

Also required:

- For CNOMO¹⁾ lock inserts, type G, 6.5 mm triangular insert 8618.308, see page 129

Lock insert

for installation in comfort handle VX,
Ergoform-S standard

Installation in			
	Lock and push-button inserts		Profile half-cylinders
	Comfort handle ⁶⁾	Comfort handle ⁷⁾ Ergoform-S standard	Comfort handle ⁷⁾ Ergoform-S standard
Model No.			
Security lock insert Lock no. 3524 E ¹⁾	8611.180	2467.000	-
Push-button insert	8611.190	2468.000	-
Push-button and lock insert ¹⁾	8611.200²⁾	2469.000³⁾	-
to DIN 18 252 ⁴⁾	-	-	9785.040⁸⁾
	-	-	9785.042⁵⁾

¹⁾ With two keys

²⁾ Lock no. 12321; no other lock is possible

³⁾ Lock no. 2123; no other lock is possible

⁴⁾ With 3 keys for each lock insert

⁵⁾ Packs of two, simultaneous locking within the same pack, no simultaneous locking for different packs

⁶⁾ For lock inserts

⁷⁾ For profile half-cylinders

⁸⁾ Different closures



Lock insert

Design		G
		
Material	Packs of	Die-cast zinc
Model No.		
7 mm square	1 pc(s).	8618.300
8 mm square	1 pc(s).	8618.301
7 mm triangular	1 pc(s).	8618.302
8 mm triangular	1 pc(s).	8618.303
Screwdriver	1 pc(s).	8618.304
Daimler insert	1 pc(s).	8618.305
3 mm double-bit	1 pc(s).	8618.306
Fiat	1 pc(s).	8618.307
6.5 mm triangular (CNOMO)	1 pc(s).	8618.308



Doors/locks

Lock system



Multiple lock for 6 padlocks

The ideal solution in cases where several people need individual access for maintenance and repair purposes.

Material:

- Sheet steel

Surface finish:

- Zinc-plated

Packs of	Model No.
2 pc(s).	2493.500



Safety lock

Fitted to doors, to protect against contact with live electrical equipment whilst the master switch is ON.

Function:

- Locks the door when the master switch is ON.
- Mains power (voltage) is only enabled whilst the door is closed.
- Monitoring of the lock magnet via an additional closing contact.

Supply includes:

- Lock
- Actuator
- Angle bracket
- Assembly parts

Connection voltage for lock magnet	Model No.
230 V AC 11 VA	2416.000
24 V DC 8 W	2418.000
120 V AC 8 VA	2419.000







! Also required:

- For twin-door enclosures (for the overlapping door, to indicate "enclosure door closed*"): Door-operated switch 4127.010



Enclosure key

				
	Model No.			
	-	-	2549.000	2549.500²⁾
Double-bit no. 5	2531.000	-	■	■
Security lock no. 3524 E	-	2532.000¹⁾	-	-
7 mm triangular	2545.000	-	-	■
8 mm triangular	2546.000	-	■	■
7 mm square	2547.000	-	-	■
8 mm square	2548.000	-	■	■
For Daimler	2521.000	-	-	-
For Fiat	2308.000	-	-	-

¹⁾ Packs of 2

²⁾ With bit adaptor and reversible bit for: Multi-tooth size 25 and 30

Comfort handle AX

for swing frame, large

The unlatched handle folds out forwards, and swivels to open the lock. Prepared for the installation of lock inserts or for the installation of standard commercially available 40 or 45 mm profile half-cylinders, as well as lock and push-button inserts. Other variants prepared for ASSA, oval profile half-cylinder up to a maximum overall length of 26.9 mm and KESO/KABA profile half-cylinder up to a maximum overall length of 42.5 mm and a \varnothing of 22 mm.

					
	For lock inserts or profile half-cylinders	With security lock insert E1 ¹⁾	For padlocks and lock inserts or profile half-cylinders	Prepared for ASSA lock system	Prepared for KESO/KABA lock system
	Model No.				
Die-cast zinc RAL 7035	2435.100	2435.200	2435.400	2435.500	2435.600
Lock inserts, type A					
7 mm square	2460.000	–	2460.000	–	–
8 mm square	2461.000	–	2461.000	–	–
7 mm triangular	2462.000	–	2462.000	–	–
8 mm triangular	2463.000	–	2463.000	–	–
Screwdriver	2464.000	–	2464.000	–	–
Daimler insert	2465.000	–	2465.000	–	–
3 mm double-bit	2466.000	–	2466.000	–	–
Fiat	2307.000	–	2307.000	–	–
6.5 mm triangular	2460.650	–	2460.650	–	–
Lock and push-button inserts					
Lock insert, lock no. 3524 E ¹⁾	2467.000	–	2467.000	–	–
Push-button insert	2468.000	–	2468.000	–	–
Push-button and lock insert ¹⁾	2469.000 ²⁾	–	2469.000 ²⁾	–	–
Profile half-cylinders					
to DIN 18 252 ³⁾	9785.040 ⁵⁾	–	9785.040 ⁵⁾	–	–
	9785.042 ⁴⁾	–	9785.042 ⁴⁾	–	–

¹⁾ With two keys

²⁾ Lock no. 2123; no other lock is possible

³⁾ With 3 keys for each lock insert

⁴⁾ Packs of two, simultaneous locking within the same pack, no simultaneous locking for different packs

⁵⁾ Different closures





Punched section with mounting flange, 14 x 39 mm

The punched section with mounting flange, 14 x 39 mm, allows completely flexible door installation on the tubular door frame, no machining required.



Spacers

Spacer bolts allow a mounting level to be quickly and easily created at the correct distance, onto which a top hat rail or a contact hazard protection cover for built-in components can be easily installed in the door.



Ride-up roller

Even the heaviest populated door is easily opened and closed with the ride-up roller.



Door stay

The door stay for escape routes guarantees convenience and safety. The enclosure door is securely locked into position for assembly work. In dangerous situations, the stay is released automatically under pressure, and by using 180° hinges, escape routes can be kept clear in both directions.

Wiring plan lectern

During maintenance work, the wiring plan lectern folds out easily to hold circuit diagrams and documents. The integral punchings provide temporary accommodation for tools.

Partial mounting plate

With partial mounting plates, even preconfigured assemblies are readily fitted to the tubular door frame.

Tubular door frame

The all-round T-head punchings allow simple, fast attachment of cables with standard commercially available cable ties.



Doors/locks

Door, internal



Punched section with mounting flange, 14 x 39 mm

Secure location and fast mounting on the tubular door frame.

For attaching

- Cable ducts
- Cable conduit holders
- Equipment installed on the door, etc.

Material:

- Sheet steel

Surface finish:

- Zinc-plated

Supply includes:

- Assembly parts

For door width mm	Packs of	Model No.
400	4 pc(s).	8619.700
500	4 pc(s).	8619.710
600	4 pc(s).	8619.720
800	4 pc(s).	8619.730
900	4 pc(s).	8619.740
1000	4 pc(s).	8619.750

+ Accessories:

- Screws and self-tapping screws M5 for configuring the customer's own components on the punched section with mounting flange, see page 172

Spacers

The universal assembly component for all situations where a distance from the mounting level is required. With self-tapping thread for 4.5 mm diameter holes. The following components may be attached to the rear using 5.5 x 13 mm screws:

- Top-hat / cross rails
- Contact hazard protection covers
- Master switch trim panels
- Cable clamp rails
- etc.

Material:

- Hexagonal steel (SW8)

Surface finish:

- Zinc-plated

+ Accessories:

- Screws 5.5 x 13 mm, see page 172

Length mm	Packs of	Model No.
25	12 pc(s).	2311.225
50	12 pc(s).	2311.250

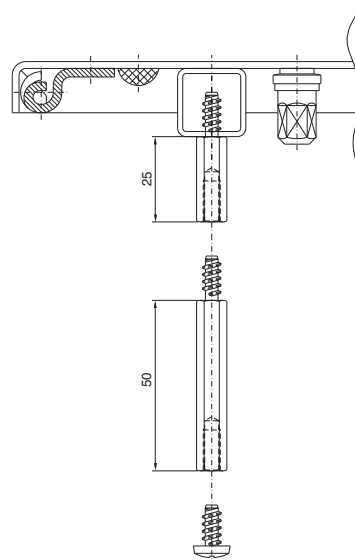

Utility lectern

For programming units etc., prepared for mounting on the tubular door frame or on any sufficiently large surface. When required for servicing, it folds out quickly with a maximum support area, and after use is lowered between the tubular door frames in a space-saving design.

Load capacity:

- Max. 300 N

Material:

- Sheet steel

Colour:

- RAL 7035

Support area		For door width mm	Model No.
Width mm	Depth mm		
413	400	600	4638.600
613	400	800	4638.800

Doors/locks

Door, internal

Wiring plan lectern

Holds wiring plans during fault-finding and maintenance work. Wiring plan lecterns may be bayed in line with the door width. For mounting on the tubular door frame.

Material:

- Utility lectern:
- Mounting bracket: Die-cast zinc

Colour:

- Similar to RAL 7035

Supply includes:

- Wiring plan lectern (width 210 mm)
- Assembly parts

For door width mm	Required/possible number of wiring plan lecterns	
	min.	max.
400	1	1
500	1	1
600	2	2
800	2	3
1000	3	3

Packs of	Model No.
1 pc(s).	4120.000



Storage box

For fixing to all flat, clean surfaces with double-sided adhesive tape. Secure storage of CDs/DVDs, small parts such as fuses etc.

Capacity:

- Max. 10 CDs/DVDs

Material:

- Polyamide

Packs of	Model No.
1 pc(s).	2446.000



Wiring plan pocket, sheet steel

For fastening to tubular door frames at any height.

Colour:

- RAL 7035

Supply includes:

- Assembly parts

D = 90 mm

To fit door width mm	Clearance openings mm		Model No.
	W	H	
400	255	210	4114.000
500	355	210	4115.000
600	455	210	4116.000
800	655	210	4118.000
900	755	210	4123.000
1000	855	210	4124.000

D = 35 mm

To fit door width mm	Clearance openings mm		Model No.
	W	H	
500	355	210	4115.500
600	455	210	4116.500
800	655	210	4118.500



Wiring plan pocket, plastic

For adhering to surfaces.

Material:

- Polystyrene with self-adhesive fastening strips

Colour:

- Similar to RAL 7035

For format	Clearance openings mm			Model No.
	W	H	T	
A3 landscape	438	286	45	2513.000
A4 portrait	228	254	17	2514.000
A5 landscape	228	174	17	2515.000



Doors/locks

Door, internal



Wiring plan pocket with transparent pouch

With welded-on transparent pouch and self-adhesive backing.

For format	Model No.
A4	2510.000
A3	2512.000

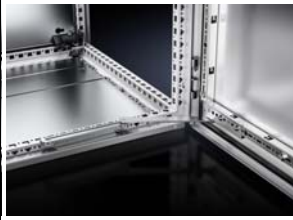

Door stay

To secure the door in the open position. May be fitted without machining the enclosure/housing.

Supply includes:
– Assembly parts

Assembly	Packs of	Model No.
bottom	1 pc(s).	8618.430



Door stay for escape routes

In an emergency situation, conventional door stays could block the escape route. The stay is activated automatically by pressure, releasing the door in both directions. In conjunction with 180° hinges, this ensures that no escape routes are blocked by open doors in the event of an emergency. The space-saving design does not obstruct the installed equipment in the door.

Supply includes:
– Assembly parts

Packs of	Model No.
1 pc(s).	8618.425

+ Accessories:

- 180° hinge, see page 119

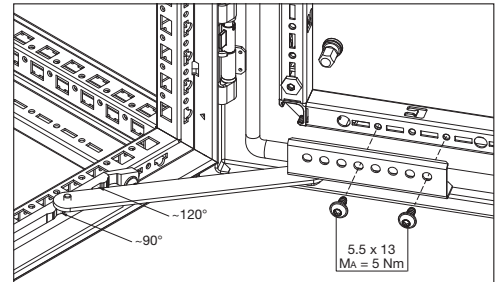

Ride-up roller for door

Lifts up the door when there is heavy installed equipment (e.g. cooling unit) as a closing aid. For attaching to the tubular door frame.

Packs of	Model No.
10 pc(s).	8618.420

Transport and mounting handle

For safe installation and removal of the door and during relocation in the workshop.

Packs of	Model No.
1 pc(s).	2415.100



Shipping brace

To stabilise the door when transporting from an additional weight load of 15 kg.

Material:

- Plastic

Colour:

- RAL 7035

Supply includes:

- Assembly parts

Packs of	Model No.
10 pc(s).	8618.410



Doors/locks

Viewing window



System window

To cover display and operating elements or cut-outs, and to protect against dirt and liquids as well as unauthorised access.

Consisting of the following 2 components:

1. Base frame:

- Easily screw-fastened to the door thanks to modified dimensions (tubular door frame may be used as a drilling template)
- Readily height-adjustable
- Stabilises the door cut-out
- Conceals the cut edge
- The rain canopy
 - prevents dirt from landing on the seal
 - protects the glass from being lifted out
 - prevents the ingress of dirt, and prevents moisture from running behind the window when opened
- Frame section height 30 mm or 60 mm

2. Viewing window:

- Made from single-pane safety glass:
 - High level of resistance to solvents and scratches
 - Anti-static
 - Reduced risk of injury if broken
- Cam lock with double-bit insert, may be exchanged for lock inserts, type A, and semi-cylinders in the Ergoform-S lock system (not for 2735.500 and .560)
- Hinge with 180° opening angle, easily inserted

Material:

- Extruded aluminium sections with die-cast zinc corner pieces and single-pane safety glass

Surface finish:

- Base frame: Powder-coated in RAL 7035
- Hinge and lock section: Natural-anodised

Protection category IP to IEC 60 529:

- IP54

Note:

- Not suitable for outdoor siting

30 section

To fit enclosure width mm	Window size, exterior mm		Model No.
	W	H	
600	500	270	2735.500
		370	2735.510
		470	2735.520
		570	2735.530
800	700	670	2735.540
		270	2735.560
		370	2735.570
		470	2735.580
		570	2735.590
		670	2735.250

60 section

To fit enclosure width mm	Window size, exterior mm		Model No.
	W	H	
600	500	370	2736.510
		470	2736.520
		570	2736.530
		670	2736.540
800	700	670	2736.500

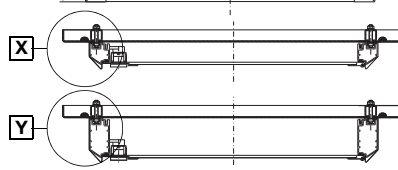
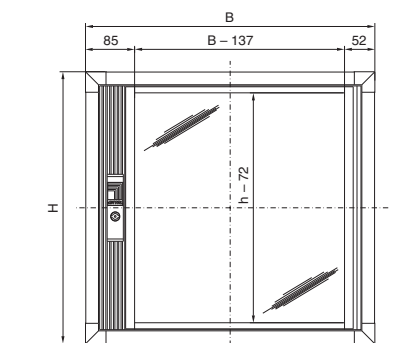

Viewing area (B - 137) offset by 16.5 mm towards the hinge side

B = W

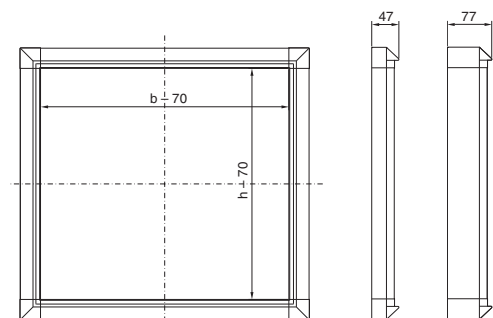

View X
for profile height 30

View Y
for profile height 60

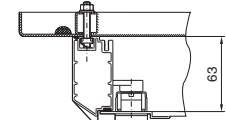
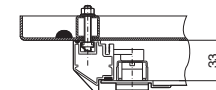

Doors/locks

Viewing window

Viewing window

Stainless steel

Fitted as standard with internal 130° hinges and all-round seal. The double-bit lock insert may be exchanged for 27 mm lock inserts, type A.

Material:

- Stainless steel 1.4301 (AISI 304)
- Single-pane safety glass

Protection category IP to IEC 60 529:

- IP54

Supply includes:

- Assembly parts

Width mm	Height mm	Depth mm	Model No.
522	600	38	2793.560



Accessories:

- Lock inserts 27 mm, type A, see page 131

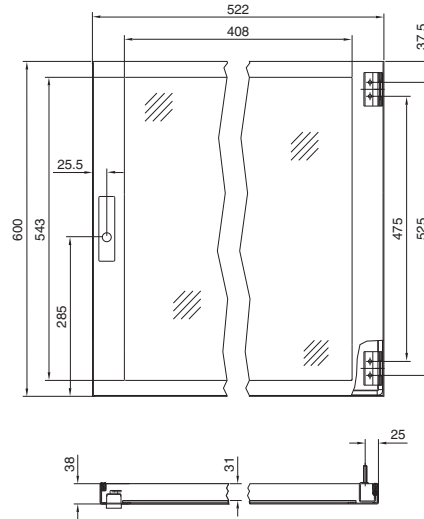

Identification strip

For individual field identifiers on the door, including transparent cover and assembly parts.

For labels:

Width -150 mm

Height: 29 mm

Thickness: ± 0.75 mm

Colour:

- RAL 7035

For enclosure width mm	Model No.
600	8618.450
800	8618.451



Keyboards, supports and drawers



Fold-out tray

for keyboard and mouse

- For installation in
- 600 and 800 mm wide doors
 - 482.6 mm (19") swing frames and enclosures

Standard double-bit lock insert may be exchanged for 27 mm lock inserts, type A, and for lock cylinder 2571.000.

Material:

- Flap: Sheet steel
- Side parts: Cast aluminium
- Tray: Extruded aluminium section

Surface finish:

- Flap, side parts: Textured paint
- Tray: Natural anodised

Colour:

- Flap, side parts: RAL 7035

Protection category to IEC 60 529:

- IP55

Protection category NEMA:

- NEMA 12



Accessories:

- Mousepad support, pull-out, see page 140

Mounting cut-out

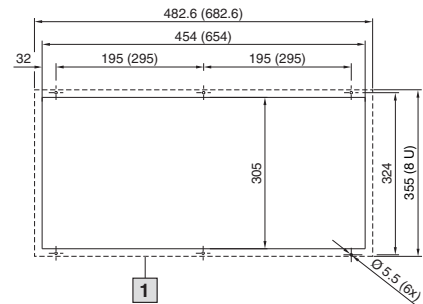

1 Support surface

For door width mm	External dimensions W x H x D mm	Installation depth mm	Max. keyboard size W x H x D mm	Model No.
600	482.6 (19") x 355 (8 U) x 126	93	405 x 45 x 245 405 x 45 x 190 ¹⁾	2379.600
800	682.6 x 355 (8 U) x 126	93	605 x 45 x 245 605 x 45 x 190 ¹⁾ 475 ¹⁾ x 45 x 245	2379.800

¹⁾ Maximum keyboard size with holder for mouse

Support for mousepad, pull-out

with mouse holder

For screw-fastening into the fold-out tray 2379.600/2379.800, see page 140.

To fit all standard mousepads up to 250 x 205 mm.

Colour:

- RAL 7035

Supply includes:

- Assembly parts

Packs of	Model No.
1 pc(s).	2379.900



010101011101010010110101
10100110100101010110101
010101011101010010110101
110101010111010010110100
010100110100101010110101

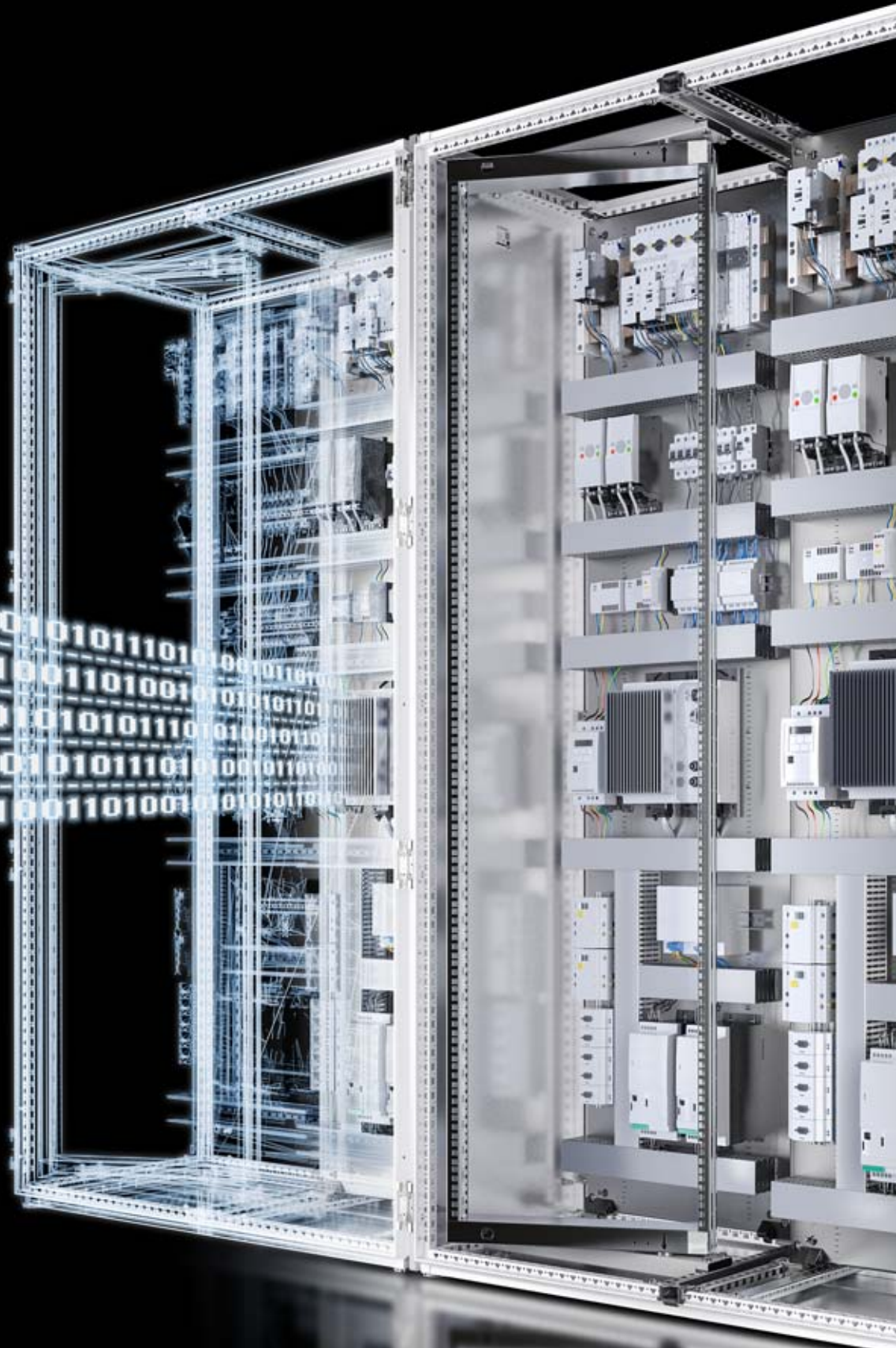



Eyebolts

For transporting by crane, the standard roof fixing screw is easily exchanged for eyebolts, or in the case of bayed enclosure suites, combined with the combination angle. With both variants, the automatic potential equalisation is retained.



Spacer

Spacers are available in three different heights, so that the roof can easily be raised for ventilation purposes.



Dust guard trim

The dust guard trim prevents dust from depositing on the upper edge of the door and in the gap between the door and the horizontal enclosure section. The integral transparent plastic is a simple way of adding individual labelling or branding to the enclosure module.



Wall bracket

For enclosures with a low depth or heavy equipment in the door or swing frame, the wall brackets provide stability.



Pressure stopper

The pressure stopper allows retrospective fitting of a pressure relief function to comply with health and safety regulations for arc-proofing to IEC/TR 61 641.



Punched section with mounting flange

Standard punched sections may also be used to support the roof and side panels. This simplifies engineering and assembly, and relieves pressure on the parts warehouse.



Top-mounting module

The top-mounting module quickly and easily creates 200 mm extra space in the height for busbar systems across enclosures, or for a cable chamber in the roof space. The base/plinth system VX can also be used for simple cable routing and panelling.



Roof

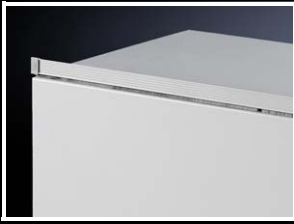

Dust guard trim

To protect against dust deposits on the upper edge of the door and between the door and upper horizontal enclosure section. The dust guard trim provides space for texts or company logos.

Colour:
– RAL 7035

Supply includes:

- Clear plastic strip for text labels (height 29.5 mm)
- Assembly parts

Length mm	Packs of	Model No.
600	1 pc(s).	2424.100
800	1 pc(s).	2425.100
1000	1 pc(s).	2427.100
1200	1 pc(s).	2426.100

Note:

- Also suitable for use in conjunction with top baying cover, see page 114



Top-mounting module

As a cable chamber for cable infeed from above, or for power distribution with busbar systems across bayed enclosures. The cover plate supplied as standard is used to finish off at the top. The enclosure height is increased by 200 mm with the top-mounting module fitted. Installation accessories for top and bottom, see diagram and explanations below.

Material:
– Sheet steel, 1.5 mm

Surface finish:
– Spray-finished, textured paint

Colour:
– RAL 7035

Protection category IP to IEC 60 529:
– IP55

Protection category NEMA:
– NEMA 12

For enclosures		Packs of	Model No.
Width (B) mm	Depth mm		
600	600	1 pc(s).	8618.501
800	600	1 pc(s).	8618.511
1000	600	1 pc(s).	8618.521
1200	600	1 pc(s).	8618.531

Supply includes:

- 1 frame module
- 2 trim panels (front and rear)
- 8 retainers with automatic potential equalisation
- Assembly parts



Also required:

- Side panel for top-mounting module 8618.540, see page 145

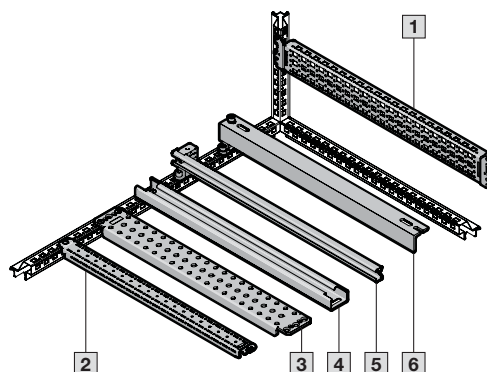
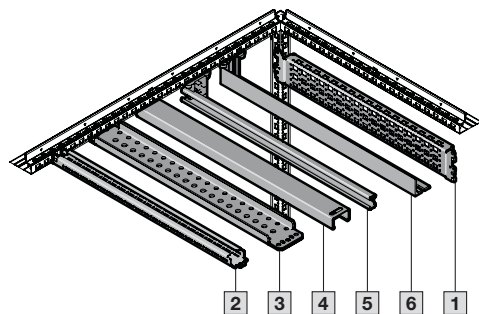
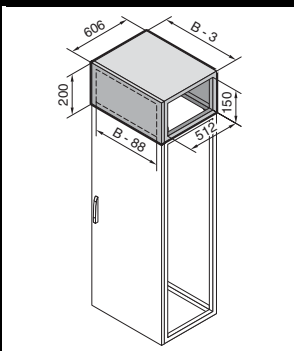

Accessories:

Description	Page
1 Punched section with mounting flange 23 x 64 mm (for the inner level)	164
2 Punched rail 18 x 39 mm	166
3 Support rail 75 x 20 mm	168
4 Support rail 48 x 26 mm	167
5 C rail 30/15	167
6 Cable clamp rail	204

Side panel

for top-mounting module

To finish off the side of a top-mounting module or bayed suite.

Material:

- Sheet steel, 1.5 mm

Surface finish:

- Spray-finished, textured paint

Colour:

- RAL 7035

Supply includes:

- Assembly parts

Packs of	Model No.
2 pc(s).	8618.541



Spacers

for roof plate

To raise the roof for ventilation purposes, in three different heights.

Thread: M12

Material:

- Hexagonal sectional steel

Surface finish:

- Zinc-plated

Supply includes:

- Assembly parts

Height mm	Packs of	Model No.
10	4 pc(s).	2422.000
20	4 pc(s).	2423.000
50	4 pc(s).	7967.000



Eyebolts

For transporting enclosures by crane.

Thread: M12

Supply includes:

- 4 eyebolts M12
- 4 serrated sealing washers A 12.5

Material	Packs of	Model No.
Sheet steel, zinc-plated, C 15E	4 pc(s).	4568.000
Stainless steel 1.4301 (AISI 304)	4 pc(s).	4568.500



Wall bracket

For attaching enclosures with a shallow depth and e.g. heavy components on the door or a built-in swing frame, to a wall at the top.

Material:

- Sheet steel

Surface finish:

- Zinc-plated

Packs of	Model No.
4 pc(s).	4595.000



Roof

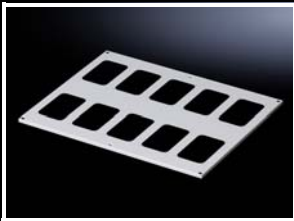

Roof plate

For enclosures without roof plate and in exchange for the standard roof.

Material:

- Sheet steel, 1.5 mm

Surface finish:

- Textured paint

Colour:

- RAL 7035

Supply includes:

- Assembly parts

Protection category IP55, solid

For enclosures		Packs of	Model No.
Width mm	Depth mm		
400	600	1 pc(s).	9681.646
600	600	1 pc(s).	9681.666
800	600	1 pc(s).	9681.686
400	800	1 pc(s).	9681.648
600	800	1 pc(s).	9681.668
800	800	1 pc(s).	9681.688
600	1000	1 pc(s).	9681.660
800	1000	1 pc(s).	9681.680
600	1200	1 pc(s).	9681.662
800	1200	1 pc(s).	9681.682

Accessories:

Pressure stoppers, see page 147

Eyebolt, see page 145

Protection category IP2X with ventilation hole, build height: 72 mm

For enclosures		Packs of	Model No.
Width mm	Depth mm		
400	600	1 pc(s).	9681.846
600	600	1 pc(s).	9681.866
800	600	1 pc(s).	9681.886
1000	600	1 pc(s).	9681.806
1200	600	1 pc(s).	9681.826
400	800	1 pc(s).	9681.848
600	800	1 pc(s).	9681.868
800	800	1 pc(s).	9681.888
1000	800	1 pc(s).	9681.808
1200	800	1 pc(s).	9681.828

For cable entry glands

For enclosures		Required no. of glands	Packs of	Model No.
Width mm	Depth mm			
600	400	2	1 pc(s).	9681.564
850	400	3	1 pc(s).	9681.594
1100	400	4	1 pc(s).	9681.514
400	600	3	1 pc(s).	9681.546
600	600	4	1 pc(s).	9681.566
800	600	8	1 pc(s).	9681.586
850	600	6	1 pc(s).	9681.596
1100	600	8	1 pc(s).	9681.516
400	800	4	1 pc(s).	9681.548
600	800	8	1 pc(s).	9681.568
800	800	8	1 pc(s).	9681.588

Also required:

Cable entry gland, see page 147

Accessories:

Eyebolt, see page 145

Pressure stoppers

for roof plate

For converting the IP55 roof plate into a roof plate with pressure relief function. The pressure relief function is essential for compliance with health and safety regulations for arc-proofing to IEC/TR 61 641. After fitting the pressure stopper, a protection category of IP54 is achieved.

Material:

- Polyamide

Supply includes:

- 4 warning stickers
- Including seal

Packs of	Model No.
4 pc(s).	9674.790

Note:

- 2 pressure stoppers and 1 warning sticker are required for one roof plate
- The arc-proofing compliance limits are dependent on the busbar system used
- The arc fault kits 9686.400 – 9686.430 are suitable for achieving arc flash class A (personal protection) and B (human safety and protection of equipment) to IEC/TR 61 641. Further information can be found on the Internet.



Cable entry gland

for roof plate

For simple, secure cable entry in the roof zone.

External dimensions: 250 x 160 mm

Colour:

- RAL 7035

Protection category IP to IEC 60 529:

- IP55

Supply includes:

- Including seal



Design	Material	Packs of	Model No.
1 14 x M25/32	Insulating material	1 pc(s).	9665.750
2 2 x M25/32/40, 1 x M32/40/50, 2 x M40/50/63	Insulating material	1 pc(s).	9665.760
3 With sealing membranes 32 x Ø 7 – 16 mm, 4 x Ø 10 – 20 mm, 3 x Ø 14 – 26 mm	Insulating material	1 pc(s).	9665.770
4 With entry fittings up to Ø 66 mm	Insulating material	1 pc(s).	9665.780
5 Solid	Sheet steel, spray-finished	4 pc(s).	9665.785

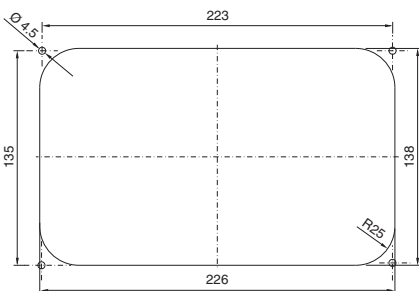

Cut-out dimensions for 9665.750 to 9665.785

Mounting plates



Earthing

The keyhole opening allows simple retrospective earthing of the mounting plate from the front while in an installed state, without having to hold a screw or nut behind the mounting plate.



Transportation

For transportation purposes, or with high dynamic loads, the mounting plate can easily be additionally secured at the top and bottom with a screw attachment.



Installation options

The mounting plate may be installed in the enclosure from all sides. Up to three mounting plates may be installed simultaneously in one enclosure; back-to-back mounting is also supported. For example, this allows an enclosure with a door instead of a rear panel to be populated from the front and rear in a space-saving solution.



Depth adjustment

The mounting plate supports straightforward depth adjustment on a 25 pitch pattern using slide blocks and the patented mounting plate attachment at the top. Using a special installation kit, the mounting plate may be offset by a further 20 mm in the depth, and populated mounting plates may also be installed from the rear.

System divider

Divides the enclosure width into two zones. For example, this allows mounting plates, cable clamp rails or swing frames from 600 mm wide enclosures to be fitted in 1200 mm wide enclosures.

Mounting surface

In the rearmost installation position, the mounting plate forms a continuous installation space with the enclosure frame. In a set forward position, a separate mounting plate infill performs this role.

Partial mounting plates

The partial mounting plates quickly and flexibly create additional mounting surfaces at all enclosure levels. They may be used as a component shelf, and can also be hinged to retain access to the mounting level behind. May even be used on the tubular door frame. The keyhole attachment ensures extremely fast, safe assembly by simply locating into position and securing.



Interior installation

Mounting plates



Mounting positions

The mounting plate included with the supply, together with the

- Mounting plate infills
- Partial mounting plates
- etc.

available as accessories, lend themselves to extremely flexible use inside the enclosure, enabling you to achieve the ideal mounting position for every application.

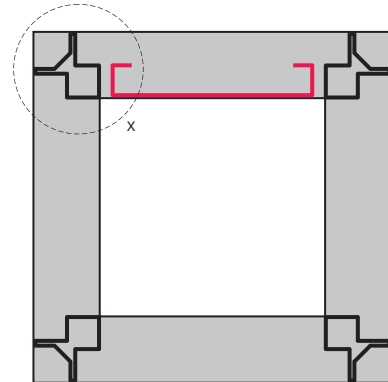

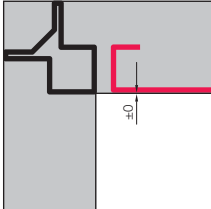
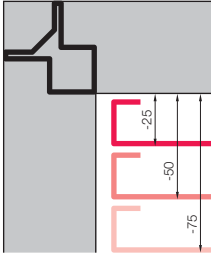
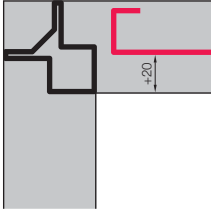
Detail X	Mounting position Mounting plate	Function	Benefits
	Flush with the enclosure frame Position: ±0 mm	Included for enclosures with mounting plate.	The mounting plate and enclosure frame create a continuous mounting surface at the same depth. Simple top-mounting of the enclosure frame is supported, and can be used for continuous enclosure-to-enclosure cable trunking, support rails etc. The usable mounting width is enlarged by up to 25%, depending on the enclosure selection.
	Set forward from the enclosure frame on a 25 mm pitch pattern Position: -25 mm -50 mm -75 mm etc.	Included for enclosures with mounting plate.	Creates space behind the mounting plate for the installation of components or for cable routing. Ideal for moving the centre of gravity of installed equipment closer to the centre of the enclosure, or when a short distance from the door is required, e.g. in order to fit a master switch. The distance between the mounting plate and the door is reduced on a 25 mm pitch pattern compared with the flush mounting position.
	Set back behind the enclosure frame Position: +20 mm	Via multi-functional installation kit for mounting plate 8617.370, see page 154	For maximising the installation depth in the enclosure. Particularly useful in situations where deep installations in a single enclosure, such as frequency converters, would increase the depth for the entire bayed enclosure suite. The installation depth in the enclosure is increased by 20 mm compared with the flush mounting position.

Interior installation

Mounting plates

Mounting plate infill

For a continuous mounting surface in bayed suites where the mounting plate is set forward.

Material:

- Sheet steel, 2 mm

Surface finish:

- Zinc-plated

Supply includes:

- Assembly parts

For enclosure height mm	Packs of	Model No.
1800	1 pc(s).	4590.700
2000	1 pc(s).	4591.700
2200	1 pc(s).	4592.700



Detail	Mounting position of mounting plate	Benefits
	Set forward from the enclosure frame on a 25 mm pitch pattern Position: -25 mm -50 mm -75 mm etc.	The usable mounting width is enlarged by up to 25%, depending on the enclosure selection.

Mounting plate attachment

Type A

For additional clamping and to reduce potential vibration of the mounting plate. Simple mounting directly on the enclosure frame. During installation, the mounting plate latches automatically into the mounting plate attachment. The mounting plate attachment type A keeps the front of the mounting plate completely free for unrestricted use. Populated mounting plates may be mounted from the front without dismantling the rear panel.

Packs of	Model No.
5 pc(s).	8617.353

Material:

- Spring steel

Supply includes:

- Safety clip
- Assembly parts



Detail	Mounting position of mounting plate	Installation option	Attachment to the mounting plate
	Flush with the enclosure frame Position: ±0 mm, fitted at the rear	Fitted on the left and right of the mounting plate	Latched home
	Flush with the enclosure frame Position: ±0 mm, fitted at the front	Fitted on the left and right of the mounting plate at half height	Latched home

Interior installation

Mounting plates



Mounting plate attachment

Type B

For additional clamping and to reduce potential vibration of the mounting plate.

Simple mounting directly on the enclosure frame or on the punched section with mounting flange 23 x 64 mm. The mounting plate may optionally be screw-fastened with the mounting plate attachment, or form-fit connected. Depending on the installation situation, the mounting plate attachment type B either minimally surrounds the mounting plate, or keeps the front of the mounting plate completely free for unrestricted use. May be mounted from the front or the rear, depending on the situation.

Packs of	Model No.
10 pc(s).	8617.351

Material:

- Sheet steel

Surface finish:

- Zinc-plated, passivated

Supply includes:

- Assembly parts



Accessories:

- Punched section with mounting flange 23 x 64 mm for the inner level, see page 164

Detail	Mounting position of mounting plate	Installation option	Attachment to the mounting plate
	Set forward from the enclosure frame Position: -50 mm	1 2 pc(s). per enclosure/mounting plate, at the side, half-way up the mounting plate	Screw-fastened
	Set forward from the enclosure frame Position: -50 mm	2 All-round between the enclosure and mounting plate in any quantity	Connected
	Set forward from the enclosure frame Position: -75 mm	1 2 pc(s). per enclosure/mounting plate, at the side, half-way up the mounting plate	Screw-fastened
	Set forward from the enclosure frame Position: -75 mm	2 All-round between the enclosure and mounting plate in any quantity	Connected
	Set forward from the enclosure frame 1 Position: -100 mm or larger	All-round between the enclosure and mounting plate in any quantity. One punched section with mounting flange 23 x 64 mm to match the enclosure depth is required for each mounting plate attachment.	Connected
	1 Position: -25 mm or larger		

Interior installation

Mounting plates

Mounting plate attachment

Type C

For additional clamping and to reduce potential vibration of the mounting plate. Simple mounting directly on the enclosure frame. The mounting plate may be form-fit connected and clamped with the mounting plate attachment. The mounting plate attachment type C keeps the front of the mounting plate completely free for unrestricted use. With the mounting plate installed and the rear panel dismantled, it can be fitted from the rear.

Packs of	Model No.
10 pc(s).	8617.352

- Material:**
– Sheet steel
- Surface finish:**
– Zinc-plated, passivated
- Supply includes:**
– Assembly parts

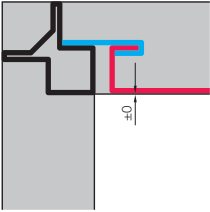
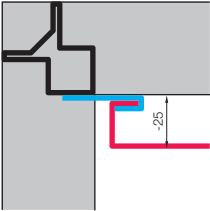
Detail	Mounting position of mounting plate	Installation option	Attachment to the mounting plate
	Flush with the enclosure frame Position: ±0 mm	All-round between the enclosure and mounting plate in any quantity	Connected, clamped
	Set forward from the enclosure frame Position: -25 mm	All-round between the enclosure and mounting plate in any quantity	Connected, clamped

Installation kit

for back-to-back mounting plates

The minimum spacing between the mounting plates facilitates maximum assemblies on both mounting plates.

- Material:**
– Sheet steel
- Surface finish:**
– Zinc-plated, passivated

Packs of	Model No.
1 pc(s).	8617.360

! Also required:

- Second mounting plate, to fit the enclosure dimensions, refer to Rittal list of spares at www.rittal.com.

+ Accessories:

- For enclosures with a rear panel, the following may be used for optimum access to the rear mounting plate: Glazed door instead of rear panel, see page 118
Lockable and adjacent door 8618.120, for enclosure dimensions W x H = 800 x 2000 mm, see page 118



Interior installation

Mounting plates

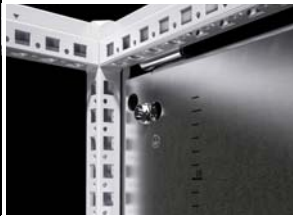

Multi-function mounting kit for mounting plate

For installing the mounting plate from the rear of the enclosure

- Mounting position flush with the enclosure frame, position ± 0
- The mounting plate is removable from the front and rear for servicing

For 20 mm more installation depth in the enclosure

- Mounting position set back behind the enclosure frame, position ± 20 mm

For additional screw-fastening of the mounting plate

- For all mounting positions

Packs of	Model No.
1 pc(s).	8617.370

Material:

- Sheet steel

Surface finish:

- Zinc-plated, passivated

Supply includes:

- Assembly parts



Slide rail

for mounting plate

For sliding the mounting plate in from the side. For mounting in a set-forward position.

Material:

- Sheet steel

Surface finish:

- Zinc-plated

Supply includes:

- Assembly parts

For enclosure width mm	Packs of	Model No.
600	2 pc(s).	8617.400
800	2 pc(s).	8617.401
1000	2 pc(s).	8617.403
1200	2 pc(s).	8617.402



Cross-brace

for mounting plates

Additional horizontal rigidity for vibration damping and/or retrospective stabilisation of wide mounting plates. This brace may also be used as an attachment aid for heavy components.

Material:

- Sheet steel

Surface finish:

- Zinc-plated

Supply includes:

- 2 sections

For enclosure width mm	Model No.
1200	4333.120
1600	4333.160
1800	4333.180

Interior installation

Mounting plates

Partial mounting plate

To accommodate additional components inside the enclosure. Partial mounting plates are extremely versatile, providing a platform for a diverse range of applications. For optional installation either upright as a vertical mounting surface, or flat as a horizontal base. For attachment either directly to the enclosure section or, with a set-forward construction, for example, to any mounting level in the enclosure using punched sections with mounting flanges. For multi-level installation one behind the other, partial mounting plates may be vertically hinged, via hinge attachment 8617.650, to allow rapid access to the levels behind.

Material:

- Sheet steel, 2.5 mm

Surface finish:

- Zinc-plated

Supply includes:

- Assembly parts

Note:

- Depending on the mounting situation, additional parts such as punched sections with mounting flanges may be required, see installation example on page 156



Accessories:

- Punched section with mounting flange for the inner and outer level, see page 164
- Hinge attachment 8617.650, see page 157

Installation examples:

See page 156



For installation in										Door width mm	Dimensions mm	Packs of	Model No.
Enclosure width mm					Enclosure depth (side) mm								
400	600	800	1000	1200	400	500	600	800					
■	■				■		■			600	500 x 300	1 pc(s).	8617.510
	■					■	■			600	500 x 400	1 pc(s).	8617.520
	■						■			600	500 x 500	1 pc(s).	8617.530
	■	■					■	■		600	500 x 700	1 pc(s).	8617.540
	■						■			600	500 x 775	1 pc(s).	8617.550
■		■			■			■		800	700 x 300	1 pc(s).	8617.560
		■				■		■		800	700 x 400	1 pc(s).	8617.570
		■						■		800	700 x 700	1 pc(s).	8617.580
■			■		■					1000	900 x 300	1 pc(s).	8617.590
			■			■				1000	900 x 400	1 pc(s).	8617.600
	■		■				■			1000	900 x 500	1 pc(s).	8617.610
■				■	■					-	1100 x 300	1 pc(s).	8617.620
				■		■				-	1100 x 400	1 pc(s).	8617.630
	■			■			■			-	1100 x 500	1 pc(s).	8617.640

Interior installation

Mounting plates

Installation examples

Full installation in the width/depth

Choose a partial mounting plate 100 mm smaller than the nominal size of the enclosure.
For example, a partial mounting plate with dimensions 500 x 700 mm can be installed in enclosures with nominal dimensions of 600 and 800 mm.

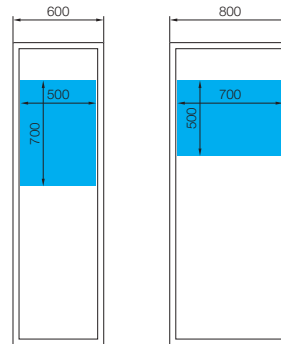

Full installation, set forward in the width/depth

For set-forward installation, punched sections with mounting flanges are required for the inner or outer mounting level, according to the enclosure depth.

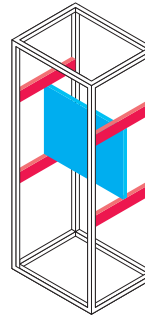

Full installation in the height

The sum total of partial mounting plates should be 100 mm smaller than the nominal size of the enclosure. For example, in a 2000 mm high enclosure, the sum total of partial mounting plates should not exceed 1900 mm.

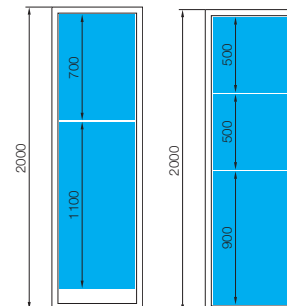

Partial installation



Also required:

- Punched section with mounting flange 23 x 64 mm (A) to match the enclosure width or depth, see page 164
- Punched section with mounting flange 23 x 64 mm (B) to match the enclosure height, see page 164

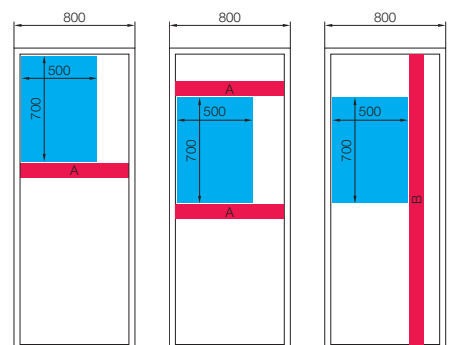

Door installation

Choose a partial mounting plate 100 mm smaller than the nominal size of the enclosure.
For example, a partial mounting plate with dimensions 500 x 700 mm can be installed on the tubular door frame of enclosures with a nominal size of 600 mm.

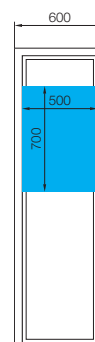

Interior installation

Mounting plates

Hinge attachment

for partial mounting plate

In conjunction with the mounting kit for swing frames, small, the partial mounting plate can be hinged to allow access to the components behind it for servicing.

Installation options:

- At the front, on the frame section
- Set back, in the enclosure depth
- At the side, in conjunction with the hinged side panel

Material:

- Steel

Surface finish:

- Zinc-plated

Supply includes:

- Assembly parts

Packs of	Model No.
1 pc(s).	8617.650

! Also required:

- Installation kit for swing frame, small, for enclosure width 600 mm (8619.600) or 800 mm (8619.610), see page 208
- Punched section with mounting flange 23 x 64 mm according to the enclosure depth, see page 164



Examples

In the highest or lowest position

Front

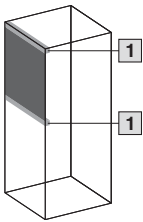

Set back

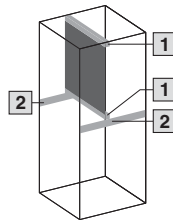

- 1 Installation kit for swing frame, small
- 2 Punched section with mounting flange 23 x 64 mm in accordance with the enclosure depth

In a central position

Front

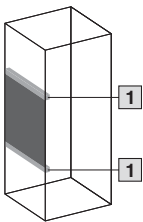

Set back

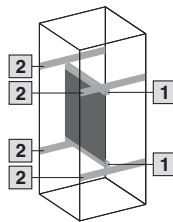

Interior installation

Mounting plates



Partial mounting plate holder for partial mounting plate VX

The partial mounting plate may be fitted set back by 20 mm behind the enclosure frame using the partial mounting plate holder, and also fastened directly to the frame from the outside. The partial mounting plate is also removable from the inside for servicing.

Material:

- Sheet steel

Surface finish:

- Zinc-plated, passivated

Supply includes:

- Assembly parts

Packs of	Model No.
4 pc(s).	8617.655

Transport handle for mounting plates

For use at any given position in the side C-fold.

Benefits include:

- Adapts to users of different heights
- Optimised force transmission
- Simple handling

Packs of	Model No.
2 pc(s).	2415.500

Partial assembly plate

Provides flexible and individual interior installation,
see page 160



Interior installation

Mounting plates



Partial assembly plate VX

To accommodate additional components inside the enclosure. Partial assembly plates are extremely versatile, providing a platform for a diverse range of applications. They are attached directly to the enclosure section. For individual interior installation, system punchings are additionally provided in the edge fold.

Material:
– Sheet steel, 1.5 mm

Surface finish:
– Zinc-plated

Supply includes:
– Assembly parts

Dimensions mm	Packs of	Model No.
500 x 400	1 pc(s).	8617.660
500 x 600	1 pc(s).	8617.661
600 x 400	1 pc(s).	8617.662
600 x 600	1 pc(s).	8617.663
800 x 400	1 pc(s).	8617.664
800 x 600	1 pc(s).	8617.665

Outer mounting level



Inner mounting level

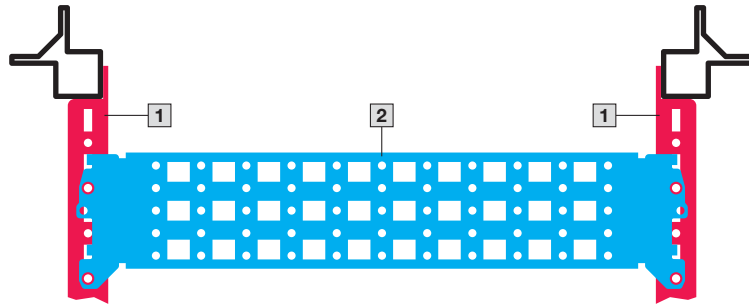

- 1 Partial assembly plate
- 2 Punched section with mounting flange, 23 x 64 mm





Enclosure frame

The patented profile is completely symmetrical across all levels and equipped with 25 mm system punchings that are consistently retained even across multiple enclosures.

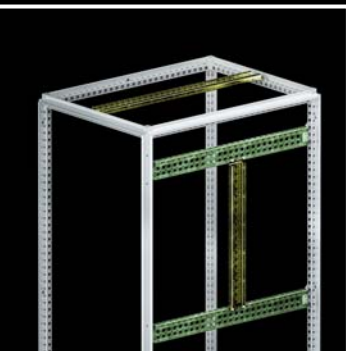
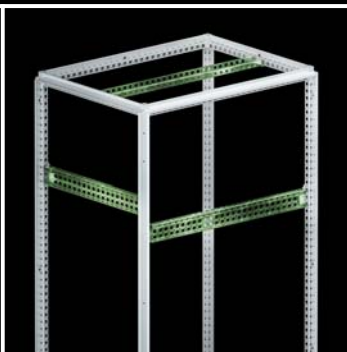
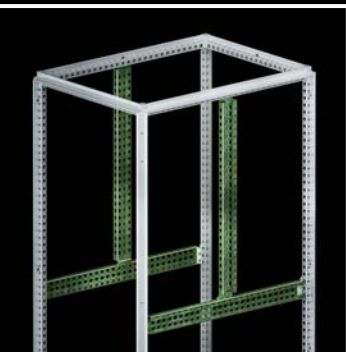
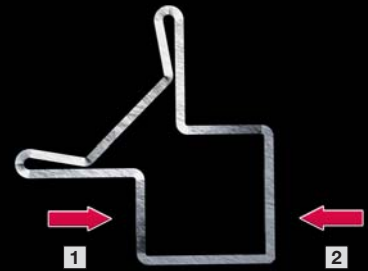

Punched section with mounting flange for the outer mounting level

The punched section may optionally be used directly on the enclosure section or in combination with the punched section with mounting flange of the inner mounting level.

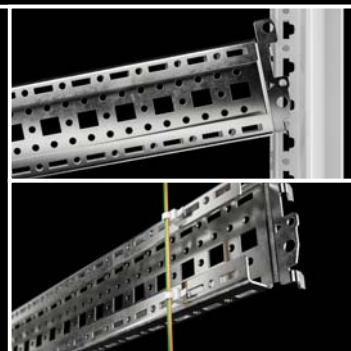

Cage nut

With their ergonomic form and integral automatic potential equalisation, the M6 or M8 cage nuts contribute to a high standard of work safety. They may be used on all levels of the VX25 enclosure system, as well as in all punched sections with 12.5 x 11 mm square punchings.



Two mounting levels

The two mounting levels, spaced 25 mm apart, allow optimum flexibility and maximise the space available for interior installation.

- 1 Outer mounting level
- 2 Inner mounting level

Punched section with mounting flange for the inner mounting level

The punched section with mounting flange supports system configuration on a 25 mm pitch pattern across all levels of the VX25, even beyond enclosure boundaries. With the system punchings, cage nuts up to M8 can be used across three levels. This allows you to securely fasten your own components with metric screws. Direct mounting on the horizontal enclosure section is also supported.

Punched section with mounting flange for the outer mounting level

The punched section is easily retro-fitted, even with the side panel already installed, because the rounded edges allow it to be screwed in. The additional C-fold may be used to support heavy installed equipment on the side panel or roof, or for attaching cable connectors.

Punched section with mounting flange, 14 x 39 mm

The punched section enables individual interior installation on the tubular door frame provided as standard.

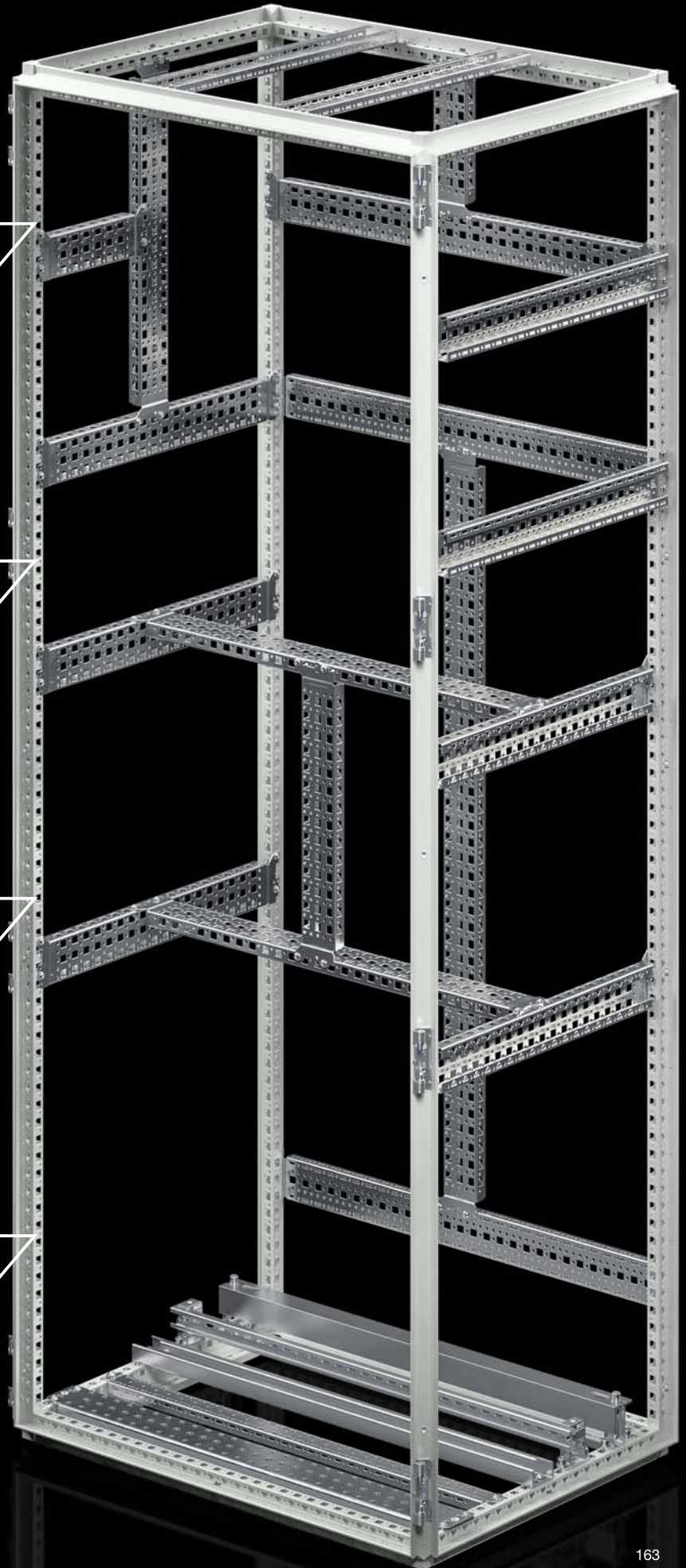

Interior installation

Rail systems

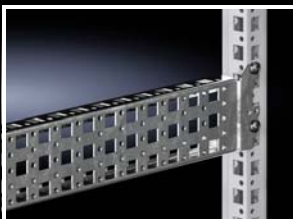
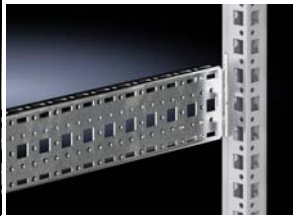

Punched section with mounting flange, 18 x 64 mm

For variable, individual interior installation of the enclosure frame on the outer mounting level. Simply locate into the system punchings from the outside and screw-fasten. System punchings on all four sides.

Installation options:

- On the outer mounting level, on the enclosure section
- On the outer mounting level, between two punched sections with mounting flanges 23 x 64 mm

Material:

- Sheet steel

Surface finish:

- Zinc-plated

Supply includes:

- Assembly parts

For enclosure width/height/depth mm	Packs of	Model No.
300	4 pc(s).	8617.000
400	4 pc(s).	8617.010
500	4 pc(s).	8617.020
600	4 pc(s).	8617.030
800	4 pc(s).	8617.040
1000	4 pc(s).	8617.050
1200	4 pc(s).	8617.060

+ Accessories:

- Screws, see page 172
- Cable ties 2597.000, see page 205

Punched section with mounting flange, 23 x 64 mm

For variable, individual interior installation of the enclosure frame on the inner mounting level. Simply locate into punchings and screw-fasten. System punchings on all four sides. With slots at the top and bottom for cage nuts, for attaching your own components via metric screws.

Installation options:

- On the inner mounting level, on the enclosure section
- On identical punched sections with mounting flanges
- Base/plinth system VX in the width and depth, combined with a base/plinth installation bracket

Material:

- Sheet steel

Surface finish:

- Zinc-plated

Supply includes:

- Assembly parts

For enclosure width/height/depth mm	Packs of	Model No.
300	4 pc(s).	8617.100
400	4 pc(s).	8617.110
500	4 pc(s).	8617.120
600	4 pc(s).	8617.130
800	4 pc(s).	8617.140
1000	4 pc(s).	8617.150
1200	4 pc(s).	8617.160
1400	4 pc(s).	8617.170
1600	4 pc(s).	8617.180
1800	4 pc(s).	8617.190
2000	4 pc(s).	8617.200
2200	4 pc(s).	8617.210

+ Accessories:

- Screws, see page 172
- Cable ties 2597.000, see page 205
- Cage nuts, see page 171
- Base/plinth installation bracket, see page 93

Interior installation

Rail systems

Punched section without mounting flange, 23 x 64 mm

For variable, individual interior installation of the enclosure frame on the inner mounting level. When mounted, the punched sections and rails sit flush to the enclosure frame. Thanks to the additional mounting bracket, they can be used with a pre-installed mounting plate and can also be cut to any required length. System punchings on all four sides. With slots at the top and bottom for cage nuts, for attaching your own components via metric screws.

Installation options:

- On the inner mounting level, on the enclosure section
- Upright or flat between two punched sections
- Between two punched sections on the inner mounting level

Material:

- Sheet steel

Surface finish:

- Zinc-plated

Supply includes:

- 1 pack =
2 punched sections without mounting flanges,
23 x 64 mm
- 4 mounting brackets

For enclosure width/height/depth mm	Packs of	Model No.
400	2 pc(s).	8100.740
500	2 pc(s).	8100.741
600	2 pc(s).	8100.742
800	2 pc(s).	8100.743
1200	2 pc(s).	8100.745

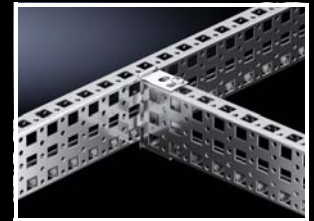
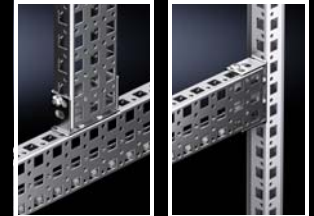

Punched section with mounting flange, 23 x 89 mm

For variable, individual interior installation of the enclosure frame on the inner mounting level. Simply locate into punchings and screw-fasten. System punchings on all four sides. With slots at the top and bottom for cage nuts, for attaching your own components via metric screws. Especially for cable routing in the base/plinth system VX, stainless steel and for the installation of busbar supports (non-magnetic stainless steel).

Installation options:

- On the inner mounting level, on the enclosure section
- On identical punched sections with mounting flanges
- In the base/plinth system VX, stainless steel, in the width and depth, combined with a base/plinth installation bracket

Material:

- Stainless steel

Supply includes:

- Assembly parts

For enclosure width/depth mm	Packs of	Model No.
400	2 pc(s).	8100.730
500	2 pc(s).	8100.731
600	2 pc(s).	8100.732
800	2 pc(s).	8100.733



Accessories:

- Screws, see page 172
- Cable ties 2597.000, see page 205
- Cage nuts, see page 171
- Base/plinth installation bracket, see page 93

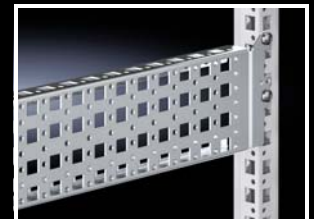

Interior installation

Rail systems



Punched rail 18 x 39 mm

For variable, individual interior installation of the enclosure frame on the inner mounting level, may also be used in conjunction with other punched sections. Prepared at the rear to accommodate cable clamps for optimum cable routing inside the enclosure

Installation options:

- On the inner mounting level, on the enclosure section

Material:

- Sheet steel

Surface finish:

- Zinc-plated

Supply includes:

- Assembly parts

For enclosure width/depth mm	Packs of	Model No.
400	4 pc(s).	8617.700
500	4 pc(s).	8617.710
600	4 pc(s).	8617.720
800	4 pc(s).	8617.730

Note:

- In enclosures with a mounting plate, two punched rails (as mounting plate slide rails) are already included with the supply



Accessories:

- Screws, see page 172
- Cable ties 2597.000, see page 205
- Cable clamps, see page 205

Support strip

For simple cable routing from the mounting plate to the door.

Installation options:

- On the inner and outer mounting level, on the enclosure section

Material:

- Sheet steel

Surface finish:

- Zinc-plated

Supply includes:

- Assembly parts

For enclosure width/depth mm	Length mm	Packs of	Model No.
400	340	20 pc(s).	4694.000
500	440	20 pc(s).	4695.000
600	540	20 pc(s).	4696.000
800	740	20 pc(s).	4697.000



Accessories:

- Screws, see page 172
- Cable ties 2597.000, see page 205

Interior installation

Rail systems

C rail 30/15 to EN 60 715

Installation options:

- On the inner mounting level, on the enclosure section
- VX base/plinth system

Material:

- Sheet steel

Surface finish:

- Zinc-plated

For enclosure width/depth mm	Length mm	Packs of	Model No.
500	455	6 pc(s).	4943.000
600	555	6 pc(s).	4944.000
800	755	6 pc(s).	4945.000
1000	955	6 pc(s).	4946.000
1200	1155	6 pc(s).	4947.000



Accessories:

- Cable clamps, see page 205
- Support bracket or spacer, see page 170
- Quick-assembly block, see page 170



Possible alternative:

- Rail for EMC shielding bracket and strain relief, see page 182



Support rail 48 x 26 mm

For heavy installed equipment such as transformers. T-head screw and slots in the support rail accommodate all mounting dimensions.

Installation options:

- On the inner mounting level, on the enclosure section

Material:

- Sheet steel

Surface finish:

- Zinc-plated

Supply includes:

- Assembly parts

For enclosure width mm	Packs of	Model No.
600	2 pc(s).	8617.800
800	2 pc(s).	8617.810
1000	2 pc(s).	8617.820
1200	2 pc(s).	8617.830



Accessories:

- Punched section with mounting flange 23 x 64 mm for height-offset installation, see page 164

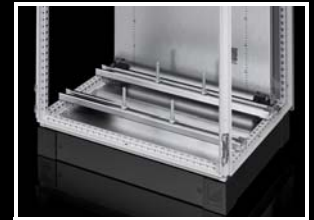

Support rail 75 x 20 mm

For heavy installed equipment such as base isolators or transformers.

Installation options:

- On the inner mounting level, on the enclosure section

Material:

- Sheet steel

Surface finish:

- Zinc-plated

Supply includes:

- Assembly parts

For enclosure width/depth mm	Packs of	Model No.	Model No.
		Slotted	Unslotted
400	4 pc(s).	4394.000	-
500	4 pc(s).	4395.000	-
600	4 pc(s).	4396.000	4396.500
800	4 pc(s).	4398.000	4398.500



Interior installation

Rail systems



Support rail 65 x 42 mm

For heavy installed equipment such as base isolators or transformers.

Installation options:

- On the inner mounting level, on the enclosure section

Material:

- Steel

Surface finish:

- Zinc-plated

Supply includes:

- Assembly parts

For enclosure width mm	Packs of	Model No.
600	2 pc(s).	8612.960
800	2 pc(s).	8612.980



Support rail TS 35/15

For snap-mounting terminals or other components with a snap-in system to EN 60 715.

For enclosure width/depth mm	Support rail length mm	Packs of	Model No.
500	455	6 pc(s).	4933.000
600	555	6 pc(s).	4934.000
800	755	6 pc(s).	4935.000
1200	1155	6 pc(s).	4937.000
-	2000	6 pc(s).	2313.150

Support rail TS 35/7.5

For snap-mounting terminals or other components with a snap-in system to EN 60 715.

For enclosure width/depth mm	Support rail length mm	Packs of	Model No.
-	2000	6 pc(s).	2313.750



Mounting clip

For fast, secure attachment of:

- Cable ducts
- Mounting plates
- Mounting angles

on support rail TS 35/7.5 and 35/15 to EN 60 715. Simply pre-assemble the mounting clip on the part to be installed, then snap into position on the support rail.

Packs of	Model No.
30 pc(s).	2309.000

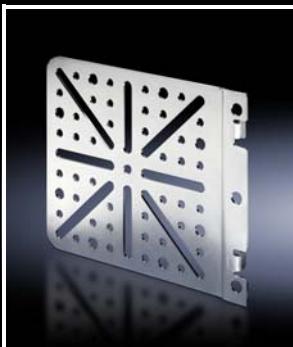

Mounting plate

Locatable

Installation options:

- On the inner and outer mounting level, on the enclosure section
- On punched sections with mounting flanges

Material:

- Sheet steel

Surface finish:

- Zinc-plated

Supply includes:

- Assembly screws

Packs of	Model No.
4 pc(s).	8612.400

+ **Accessories:**

- Screws, see page 172
- Cable ties 2597.000, see page 205

Interior installation

Rail systems

Mounting plate

Screw-fastened, large

Packs of	Model No.
4 pc(s).	8612.410

Installation options:

- On all enclosures and mounting parts with system punchings on a 25 mm pitch pattern

Material:

- Sheet steel

Surface finish:

- Zinc-plated

Supply includes:

- Assembly screws



Accessories:

- Screws, see page 172
- Cable ties 2597.000, see page 205

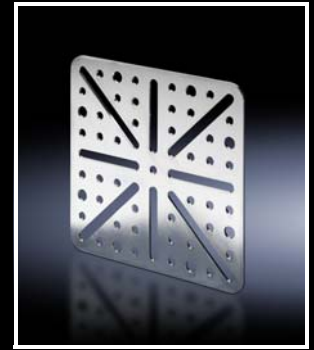

Mounting plate

Screw-fastened, small

Packs of	Model No.
4 pc(s).	4532.000

Installation options:

- On all enclosures and mounting parts with system punchings on a 25 mm pitch pattern

Material:

- Sheet steel

Surface finish:

- Zinc-plated

Supply includes:

- Assembly screws



Accessories:

- Screws, see page 172
- Cable ties 2597.000, see page 205

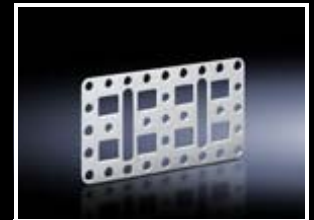

Mounting plate

with integral top-hat rail

For direct snap-mounting of components such as speed control, enclosure internal thermostat and hygrostat.

Packs of	Model No.
1 pc(s).	7526.964

Material:

- Sheet steel

Surface finish:

- Zinc-plated

Supply includes:

- Assembly parts



Mounting bracket

Installation options:

- On all enclosures and mounting parts with system punchings on a 25 mm pitch pattern

Material:

- Sheet steel

Surface finish:

- Zinc-plated

Supply includes:

- Assembly screws

Packs of	Model No.
4 pc(s).	4597.000



Accessories:

- Screws, see page 172
- Cable ties 2597.000, see page 205



Interior installation

Assembly components

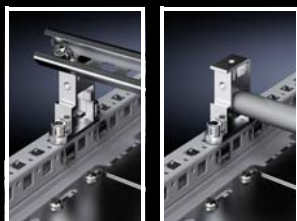

Bracket/spacer

For the attachment of C rails, punched rails or cable clamp rails (angle piece). On the sides, to accommodate square sections or tubes (\varnothing 20 mm). Attachment points with M8 thread.

Installation options:

- On the vertical and horizontal enclosure section
- On punched sections with mounting flanges for the inner mounting level

Material:

- Die-cast zinc

Supply includes:

- 1 pc(s). =
 - 1 bracket or spacer
 - 2 screws M8 x 16 mm
 - 2 spring lock washers,
 - 2 cage nuts M8
 - 2 screws

Packs of	Model No.
6 pc(s).	4199.000

Accessories:

- Angle piece 4134.000, see page 170

Quick-assembly block

For a variety of installation options.

Installation options:

- On the vertical and horizontal enclosure section
- On punched sections with mounting flanges for the inner mounting level

Material:

- Die-cast zinc

Supply includes:

- 12 quick-assembly blocks
- 12 threaded blocks M8
- 24 screws M8 x 12 mm
- 24 square nuts M8

Packs of	Model No.
12 pc(s).	4133.000

Accessories:

- Angle piece 4134.000, see page 170

Angle piece

For assembling mounting surfaces with a 45° incline.

With two mounting options as standard:

- Conductively connected to the subsurface
- Insulated from the mounting surface

Installation options:

- On the vertical and horizontal enclosure section
- On punched sections with mounting flanges for the inner mounting level
- On the bracket/spacer
- On the quick-assembly block

Material:

- Angle pieces: Die-cast zinc
- Cover section: Plastic

Supply includes:

- 1 pc(s).
 - 1 angle piece
 - 1 insulating piece
 - 1 insulating screw
 - 2 assembly screws
 - 1 threaded block M8

Packs of	Model No.
12 pc(s).	4134.000

Interior installation

Assembly components

Rail mounting bracket

For individual mounting of rails at a distance from the mounting surface.

Material:

- Sheet steel, zinc-plated

Rail mounting bracket	Packs of	Model No.
Flat	20 pc(s).	2365.000
Inclined	20 pc(s).	2366.000

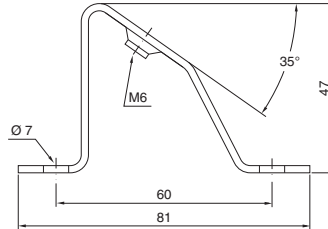
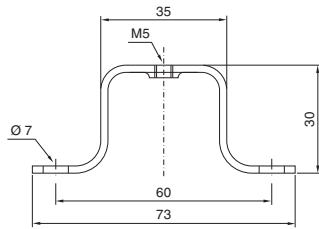

Cage nut

For all-round metric mounting on the enclosure section.

Benefits:

- For all-round mounting on the enclosure section
- The compression spring, designed as an insertion aid, ensures reliable mechanical and electrical connection in the system punchings.
- Simply slides in from the side
- Safely and easily released with a screwdriver

Installation options:

- On the vertical and horizontal enclosure section
- On punched sections with mounting flanges, 23 x 64 mm
- On punched sections with mounting flanges, 23 x 89 mm, stainless steel

Thread	Packs of	Model No.
M6	20 pc(s).	4164.500
M8	20 pc(s).	4165.500



Threaded block

For all-round metric mounting on the enclosure section. With snap-off insertion aid, made from die-cast zinc.

Installation options:

- On the vertical and horizontal enclosure section
- On punched sections with mounting flanges, 23 x 64 mm
- On punched sections with mounting flanges, 23 x 89 mm, stainless steel

Thread	Packs of	Model No.
M6	50 pc(s).	4162.000
M8	50 pc(s).	4163.000



Interior installation

Assembly components



Multi-tooth screw

- M6 x 12 to fit:
- Cage nuts 4164.500
 - U nuts 4179.000
 - Threaded blocks 4162.000

- M8 x 12 to fit:
- Cage nuts 4165.500
 - U nuts 4180.000
 - Threaded blocks 4163.000

Metal multi-tooth screw

For the round holes \varnothing 4.5 mm or 4.7 mm in the enclosure section, punched rails and punched sections without mounting flanges.



Self-tapping screw

For the round holes \varnothing 4.5 mm or 4.7 mm in the enclosure section, punched rails and punched sections without mounting flanges.



Self-tapping screw

Mark, drill and tighten in a single operation using electric or pneumatic tools.

- For metal thickness: 0.8 – 3 mm
Length: 16 mm
Usable length: \pm 9.5 mm
Width across flats: 8 mm



Multi-tooth drive for optimum transmission of torques, an extended tool life and increased safety and reliability when tightening and loosening screw connections.

Type of screw	Size mm	Packs of	ModelNo.
Multi-tooth screws	M6 x 12 M8 x 12	300 pc(s). 300 pc(s).	2504.500 2504.800
Metal multi-tooth screws	5.5 x 13	300 pc(s).	2486.600
Metal multi-tooth screws for stainless steel	5 x 13	300 pc(s).	2486.400
Self-tapping screws (hex screws)	M5 x 10	500 pc(s).	2504.000
Self-tapping screws	ST 4.8 x 16	300 pc(s).	2487.000





Component shelves

The component shelves for frame attachment enable the fast creation of support surfaces for devices; if necessary, they may also be equipped with telescopic slides. The shelves are slotted to support natural convection inside the enclosure. Additionally, the devices may be screw-fastened directly to these punchings to prevent slipping; no machining is required. The optional hinged cable support ensures secure cable routing into the enclosure.



EMC protection

The level of EMC protection in the VX25 bayed enclosure system is already high, but can be further significantly improved by adopting simple measures for cable entry. The rail for EMC shielding brackets provides strain relief as well as EMC contacting of inserted cables. The rail can be fitted on the horizontal or vertical enclosure section, as well as directly onto the mounting plate.



EMC cable glands

The EMC cable gland can be used for EMC-compatible insertion of individual cables. The lock nut creates a conductive connection with the enclosure. Cable glands can be used on all suitable surfaces on the enclosure.

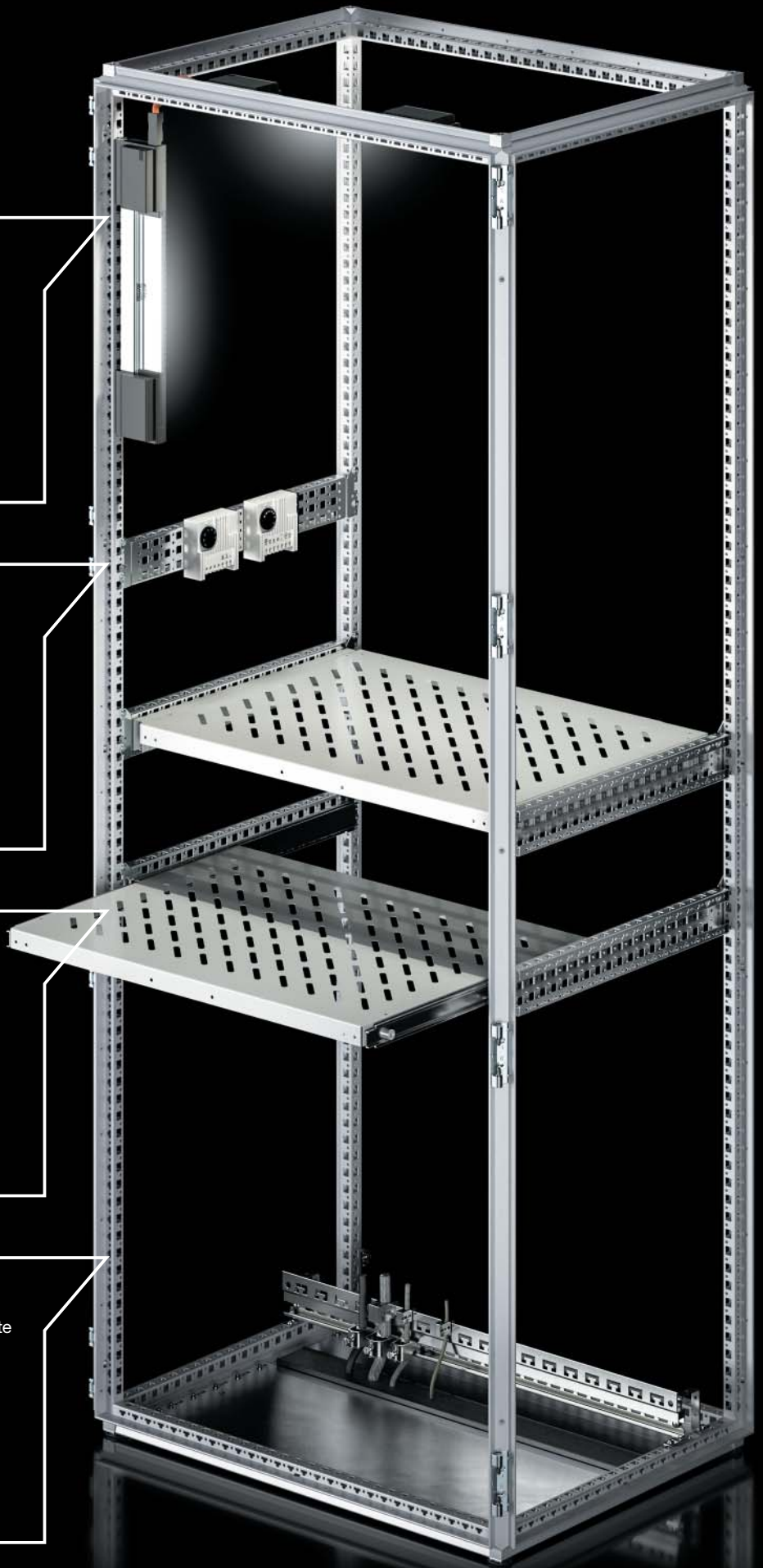

LED system light

The LED system light is specifically designed to provide optimum illumination of the entire enclosure, when fitted both horizontally and vertically. Two different Fresnel structures ensure that all the light remains inside the enclosure, illuminating every last corner. For tool-free mounting directly into the system punchings using a system of clip-in hooks.

Easy connection

Connection is just as straightforward as assembly. The rotating connectors allow user-friendly connection, even in tight spaces. The wide ranging power supply unit means that the light can be used anywhere in the world.

Thermostat/hygrostat

For optimum monitoring and adjustment of climate control.



Interior installation

Component shelves for frame attachment

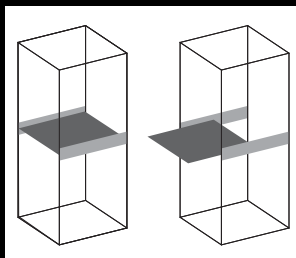

Component shelf for frame attachment

for enclosure width 600 and 800 mm

For installation in enclosures **without** 482.6 mm (19") accommodation.

Max. depth of component shelves = Enclosure depth - 100 mm.

Technical specifications:

- Mounting bolts or mounting rails may be installed on a 25 mm pitch pattern in the enclosure depth
- Mounting hole for handles provided.
- Component shelf, vented

Material:

- Sheet steel

Surface finish:

- Spray-finished

Colour:

- RAL 7035

Supply includes:

- Assembly parts

Enclosure width 600 mm

Load capacity N (static surface load)	500	500	500	500	1000	1000	1000	1000
Component shelf width mm	471	471	471	471	471	471	471	471
Component shelf depth mm	400	500	600	700	400	500	600	700
Component shelf height mm	29	29	29	29	45	45	45	45
Model No.	7164.035	7165.035	7166.035	7166.735	7464.035	7465.035	7466.035	7466.735

Enclosure width 800 mm

Load capacity N (static surface load)	500	500	500	500	1000	1000	1000	1000
Component shelf width mm	671	671	671	671	671	671	671	671
Component shelf depth mm	400	500	600	700	400	500	600	700
Component shelf height mm	29	29	29	29	45	45	45	45
Model No.	7184.035	7185.035	7186.035	7186.735	7484.035	7485.035	7486.035	7486.735

! Also required:

		Model No.
Punched section without mounting flange, 23 x 64 mm, as installation kit for enclosure depth, see page 164	500	8100.741
	600	8100.742
	800	8100.743
	1000/1200	8100.745

+ Accessories:

		Model No.							
Telescopic slides		7061.000	7081.000	7161.000	7161.700	7064.000	7065.000	7066.000	7066.700
Handles for component shelves		5501.730	5501.730	5501.730	5501.730	5501.730	5501.730	5501.730	5501.730
Cable support, hinged, with anti-kink device and clamp for enclosure depth mm	≤ 600	7163.560	7163.560	7163.560	7163.560	7163.560	7163.560	7163.560	7163.560
	> 600	7163.565	7163.565	7163.565	7163.565	7163.565	7163.565	7163.565	7163.565



Baying enclosure system VX25 Page 54 Connection accessories Page 178

Benefits:

- Optimum illumination of the entire enclosure
- Optionally with clip, screw or magnetic attachment
- Equipment to suit every application

Material:

- Plastic
- Aluminium

Colour:

- Enclosure: RAL 7016

Light colour:

- 4000 K (neutral white)

Supply includes:





- Assembly screws

Protection class:

- II (all-insulated)

Note:

- Connection accessories should be ordered separately
- Further information on country-specific versions can be found on the Internet
- Other system lights, e.g. with a lower luminosity and for compact enclosures, can be found on the Internet.

						
Model No.		2500.310	2500.300	2500.210	2500.200	2500.220
Output (lumens)		1200	1200	900	900	900
Length (mm)		437	437	437	437	437
Motion sensor		■	■	–	–	–
Rated operating voltage	100 – 240 V AC	■	■	■	■	–
	24 V DC	–	–	–	–	■
Equipment	Socket D, earthing-pin	■	–	■	–	–
	90° rotating connector	■	■	■	■	■
	Adjustable light direction	■	■	–	–	–
	Adjustable light distribution	■	■	■	■	■
Approvals	UL	–	■	–	■	■
	CSA	–	■	–	■	■
	cUL	–	■	–	■	■
	CCC	–	■	–	■	–
	ENEC	■	■	■	■	■
Installation type	Screw-fastening	■	■	■	■	■
	Clip attachment	■	■	■	■	■
	Magnetic attachment to surfaces (accessory)	–	■	–	■	■
Connection options	Infeed	3-pole	3-pole	3-pole	3-pole	2-pole
	Through-wiring	3-pole	3-pole	3-pole	3-pole	2-pole
	Door-operated switch (accessory)	–	–	■	■	■
Accessories						
Mounting kit magnet		–	2500.490	–	2500.490	2500.490
Door-operated switch		–	–	2500.460	2500.460	2500.460
Door-operated switch, UL		–	–	–	2500.470	2500.470
Also required: Connection accessories depending on application type						
Infeed, 2-pole, UL		–	–	–	–	2500.410
Infeed, 3-pole		2500.400	2500.400	2500.400	2500.400	–
Infeed, 3-pole, UL		–	2500.500	–	2500.500	–
Through-wiring, 2-pole, UL		–	–	–	–	2500.440
Through-wiring, 3-pole		2500.430	2500.430	2500.430	2500.430	–
Through-wiring, 3-pole, UL		–	2500.530	–	2500.530	–

Interior installation

LED system light

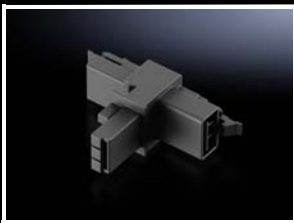
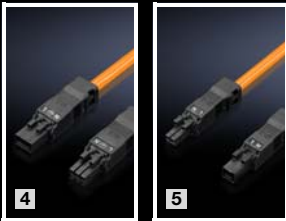
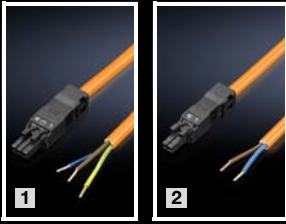

Connection accessories

for LED system light

The following components can be used for time-saving, easy installation of the lights:



Accessories:

- Cable tie 2597.000, see page 205

Connection cable for	ENEC	UL	Length mm	Packs of	Model No.	
					orange	black
[1] Infeed, 3-pole, 100 – 240 V AC	■	■	3000	1 pc(s).	2500.500	-
	■	-	3000	5 pc(s).	2500.400	-
[2] Infeed, 2-pole, 100 – 240 V AC	■	-	3000	5 pc(s).	2500.420	-
[3] Infeed, 2-pole, 24 V DC	■	■	3000	5 pc(s).	-	2500.410
[4] Through-wiring, 3-pole, 100 – 240 V AC	■	-	200	1 pc(s).	2500.435	-
	■	■	1000	1 pc(s).	2500.530	-
[5] Through-wiring, 3-pole, 100 – 240 V AC	■	-	1000	5 pc(s).	2500.430	-
	■	-	1000	5 pc(s).	2500.450	-
[6] Through-wiring, 2-pole, 24 V DC	■	■	1000	5 pc(s).	-	2500.440

- [A] Connection cable for infeed
- [W] Connection cable for through-wiring
- [C] Door-operated switch with connection cable (not required for LED system light with integral motion sensor)

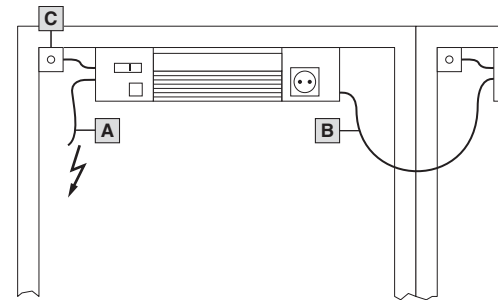

T distributor

with two sockets and one connector

For creating safe, shock-hazard-protected junctions when wiring LED system lights and socket boxes.

Packs of	Model No.
5 pc(s).	2500.680

Door-operated switch

for LED system light

Supply includes:

- Assembly parts

Protection category:

- IP40

Connection cable	ENEC	UL	Length mm	To fit	Packs of	Model No.
						black
Connection cable	■	-	800	230 V AC/24 V DC, 1 A	1 pc(s).	2500.460
	-	■	800		1 pc(s).	2500.470

Interior installation

LED system light

Mounting kit magnet for LED system light

For sticking onto the rear of lights without a socket.

Packs of	Model No.
2 pc(s).	2500.490

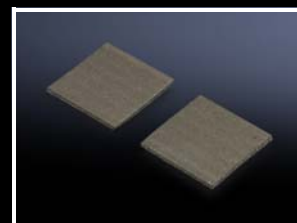

Socket box

for LED system light

In combination with the LED system light, the socket box creates a flexible modular system for international use.

Benefits:

- Identical connection accessories as for LED system light
- Cascadable with LED system light
- Supports flexible installation throughout the entire enclosure and on the tubular door frame
- No additional wiring required, thanks to simple connection technology and integration of the LED system light into the circuit

Material:

- Plastic

Colour:

- RAL 7016

Supply includes:

- Assembly parts

Configuration examples:

See from page 1020.

Socket	UL	Packs of	Model No.
	–	1 pc(s).	2500.710
	–	1 pc(s).	2500.711
	–	1 pc(s).	2500.712
	–	1 pc(s).	2500.713
	■	1 pc(s).	2500.714
	–	1 pc(s).	2500.715



Also required:

- Depending on the application, through-wiring or a 3-pole infeed may be required, see page 178



Accessories:

- T distributor, see page 178
- Through-wiring, 3-pole, see page 178
- Infeed, 3-pole, see page 178



- 1 Infeed
- 2 Socket box
- 3 Through-wiring
- 4 LED system light
- 5 T distributor

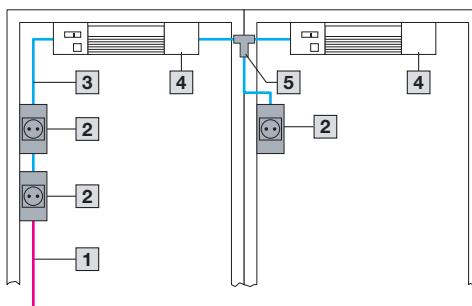

Interior installation

Climate control accessories



Thermostat

Enclosure internal thermostat

Particularly suitable for controlling fans, heaters and heat exchangers, this thermostat can also be used as a signal generator for monitoring the enclosure internal temperature.

Benefits:

- Time-saving connection technique using a terminal strip with a screw connection from the outside
- Flexible mounting on a vertical or horizontal 35 mm support rail to EN 50 022, and snap fastening in the enclosure section or on the mounting plate using the supplied adaptor

Technical specifications:

- Bi-metal controller as a temperature-sensitive element with thermal feedback
- Contact population: Single-pole change-over contact as a quick-break contact
- Permissible contact load:
Category 5 – 3 (heating):
AC 10 (4) A (inductive load at $\cos \phi = 0.6$)/
category 5 – 4 (cooling): AC 5 (4) A
(inductive load at $\cos \phi = 0.6$)/DC = max. 30 W
- Switching difference: approx. 1 K \pm 0.8 K

Colour:

- RAL 7035



Accessories:

- Bottom-mounted adaptor, see Cat. 36, page 548
- Mounting plate, see page 168

W x H x D mm	Rated operating voltage V, ~	Setting range	Packs of	Model No.
71 x 71 x 33.5	24 - 230, 1~ 24 - 60 (DC)	+5 °C...+60 °C	1 pc(s).	3110.000



Hygrostat

Activates the heater and/or fan when a preset relative humidity inside the enclosure is exceeded. This raises the relative humidity above the dew point and prevents condensation on assemblies and electronic components.

Benefits:

- Time-saving connection technique using a terminal strip with a screw connection from the outside
- Flexible mounting on a vertical or horizontal 35 mm support rail to EN 50 022, and snap fastening in the enclosure section or on the mounting plate using the supplied adaptor

Technical specifications:

- Contact population: Single-pole change-over contact as a quick-break contact
- Permissible contact load: AC ~ 5 (0.2) A
(inductive load at $\cos \phi = 0.6$)/DC = max. 20 W
- Setting range: 50 – 100% relative humidity
- Switching difference: approx. 4%

Colour:

- RAL 7035



Accessories:

- Bottom-mounted adaptor, see Cat. 36, page 548
- Mounting plate, see page 168

W x H x D mm	Rated operating voltage V, ~	Packs of	Model No.
71 x 71 x 33.5	24 - 250, 1~ 24 - 75 (DC)	1 pc(s).	3118.000

EMC side panel

Automatic potential equalisation via assembly components, and a high level of EMC protection thanks to a special EMC seal.

Material:

- Sheet steel, 1.5 mm

Surface finish:

- Magnesium zinc coated, powder-coated on the outside

Colour:

- RAL 7035

Protection category IP to IEC 60 529:

- IP55

Supply includes:

- Assembly parts

For enclosures		Packs of	Model No.
Height mm	Depth mm		
2000	600	2 pc(s).	8106.760
2000	800	2 pc(s).	8108.760



EMC shielding seal

For EMC-compliant shielding of the baying point in conjunction with external baying connector.

Protection category IP to IEC 60 529:

- IP55 in conjunction with external baying connector

Supply includes:

- 8 m

Packs of	Model No.
1 pc(s).	8800.695



Also required:

- Baying connector, external, page 112



EMC divider panel seal

With bayed EMC enclosure systems and when using a zinc-plated divider panel, this seal ensures optimum contact and shield attenuation.

Material:

- PU foam with electrically conductive sheathing

Supply includes:

- 6 m

Packs of	Model No.
1 pc(s).	4348.500



Interior installation

EMC

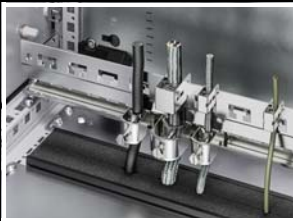

Rail

for EMC shielding bracket and strain relief

Combined rail for strain relief and EMC contacting of inserted cables.

Design:

- C rail to accommodate cable clamps
- T-head cut-outs on a 40 mm pitch pattern for cable clamping using cable ties

Benefits:

- Additional contacting on the left or right of the rail via existing holes (9 mm diameter)
- Prepared for tool-free mounting of EMC shielding brackets

Installation options:

- On the horizontal/vertical enclosure section
- On the mounting plate, may also be fitted without a retaining bracket

Material:

- Extruded aluminium section

Surface finish:

- Chrome-free passivated

Supply includes:

- 1 rail
- 2 retaining brackets
- Assembly parts

For enclosure width mm	Length mm	Packs of	Model No.
600	553	1 pc(s).	2388.650
800	753	1 pc(s).	2388.850
1000	953	1 pc(s).	2388.050
1200	1153	1 pc(s).	2388.125



Also required:

- EMC shielding bracket, see page 182
- Cable clamps, see page 205



Accessories:

- Support bracket or spacer, see page 170
- Quick-assembly block, see page 170
- Angle piece, see page 170
- Earth straps, see page 186
- Earthing braids, see page 186



Possible alternative:

- C rails 30/15, see page 167

EMC shielding bracket

Quick assembly without the use of tools: Press the EMC shielding bracket against the cable shield and clip into the rail. Diameter changes are compensated in full by the spring of the EMC shielding bracket.

Material:

- Sheet steel

Surface finish:

- Zinc-plated

For shield diameter mm	Packs of	Model No.
3 – 10	10 pc(s).	2388.100
4 – 15	10 pc(s).	2388.150
10 – 20	10 pc(s).	2388.200
15 – 28	10 pc(s).	2388.280

EMC gland plate

For shielded cables with a maximum diameter of 20 mm.

Combined EMC/IP seal provides low-resistance contact between cable shield and gland plate.

For all 400, 500, 600 and 800 mm deep enclosures in conjunction with standard gland plates.

Material:

- Sheet steel

Surface finish:

- Zinc-plated

Supply includes:

- 1 gland plate with twin hammer-head punching
- 1 sliding base plate
- 2 EMC/IP seals

Width mm	Packs of	Model No.
600	1 pc(s).	8618.820
800	1 pc(s).	8618.821
1000	1 pc(s).	8618.822¹⁾
1200	1 pc(s).	8618.823¹⁾

¹⁾ For one enclosure half only

EMC cable gland

The cable sheathing may optionally be interrupted at the contact point or removed completely inside the enclosure. The cable shielding in the enclosure is retained. The supplied lock nut cuts automatically into the paint when screwed onto spray-finished enclosure surfaces, thus creating a conductive connection.

Protection category IP to IEC 60 529:

- IP68

Cable glands, metric

Size	Cable diameter mm	Minimum shield diameter ¹⁾ mm	Packs of	Model No.
M16	4.5 – 10	3	5 pc(s).	2843.160
M20	6 – 12	5	5 pc(s).	2843.200
M25	11 – 17	8	5 pc(s).	2843.250
M32	15 – 21	10	1 pc(s).	2843.320
M40	19 – 28	15	1 pc(s).	2843.400
M50	27 – 38	19	1 pc(s).	2843.500
M63	34 – 44	30	1 pc(s).	2843.630

¹⁾ Minimum shield diameter = cable diameter minus cable sheathing



EMC shield bus

Made of corrosion-proof steel strip, 75 mm² cross section, for cable shield contact.

Supply includes:

- Assembly parts

Bar length mm	Connections	Packs of	Model No.
375	10	1 pc(s).	2413.375
550	16	1 pc(s).	2413.550



EMC earth clamp

The clamps may be used directly on the device or operating equipment on the mounting plate for cable shield contact.

Material:

- Sheet steel

Surface finish:

- Zinc-plated

Size mm	Packs of	Model No.
4	50 pc(s).	2367.040
6	50 pc(s).	2367.060
8	50 pc(s).	2367.080
12	50 pc(s).	2367.120
16	50 pc(s).	2367.160
20	25 pc(s).	2367.200¹⁾

¹⁾ 2 mounting brackets



Contact cutter

The contact cutter enables EMC-compatible preparation of the contact point e.g. for earthing braids. Plastic-bound abrasive with guide pin for round system punchings. With location point for drill, grinder etc.

For	Model No.
Frame section	2414.000
Earthing bolts ¹⁾	2414.500

¹⁾ Not necessary with VX and TS

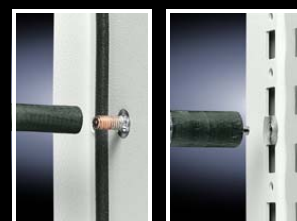

Contact paint

Contact paint prevents the corrosion of conductive, unprotected contact points.

Contents:

- 12 ml

Packs of	Model No.
1 pc(s).	2415.000



Interior installation

For areas at risk from earthquakes



The versions listed have been tested and meet the requirements to Telcordia GR 63-CORE. They should be seen as a comparative variable to the customer's own plant, since empty enclosures cannot be certified.

Note:

- Further information can be found in the white paper "Earthquake protection for switchgear systems" on the Internet

VX25 in earthquake zone 3 and 2 to Telcordia GR 63-CORE

VX 8806.000:
W x H x D:
800 x 2000 x 600 mm,
see page 63

Fitted with:

- Side panels, see page 102
- Base/plinth VX (corner pieces with base/plinth trim panels, front and rear and side base/plinth trim panels, 100 mm high), see page 89/90

VX25 for earthquake zone 3 to Telcordia GR 63-CORE

VX 8806.000:
W x H x D:
800 x 2000 x 600 mm,
see page 63

Fitted with:

- Side panels, see page 102
- Comfort handle VX, see page 128
- Earthquake base/plinth, see page 185

VX25 for earthquake zone 4 to Telcordia GR 63-CORE

VX 8806.000:
W x H x D:
800 x 2000 x 600 mm,
see page 63

Fitted with:

- Side panels, see page 102
- Comfort handle VX, see page 128
- Earthquake base/plinth, see page 185
- Earthquake kit, see page 185



Interior installation

For areas at risk from earthquakes

Earthquake base/plinth

Height 100 mm

- For stable attachment of the earthquake-resistant enclosure to the subsurface.
- External metric M6 thread for a stable connection to the subsurface from the outside

Material:

- Corner pieces: Sheet steel 5 mm
- Trim panels: Sheet steel 2 mm

Surface finish:

- Powder-coated

Colour:

- RAL 7022

Supply includes:

- 1 pc(s).
- 4 corner pieces
- 2 depth stays, 1 trim panel each front and rear fully assembled

For enclosures W x D mm	Packs of	Model No.
800 x 600	1 pc(s).	8601.860



Earthquake kit

Material:

- Sheet steel

Surface finish:

- Zinc-plated

Supply includes:

- 1 pc(s). =
- 2 side reinforcements, bottom
- 4 bracing struts, sides
- 6 gusset plates
- 2 door safety brackets
- 4 punched sections with mounting flanges, 23 x 64 mm
- 2 punched rails 18 x 39 mm
- 8 angle plates
- Mounting plate attachment
- Including assembly parts

For enclosures W x H x D mm	Packs of	Model No.
800 x 2000 x 600	1 pc(s).	8618.600



Interior installation

Earthing

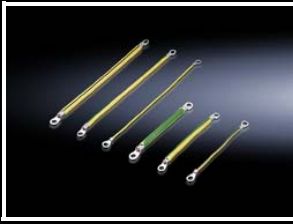

Earth strap

For configuring a reliable earthing connection with perfect contact

- With M8 ring terminals to match the earthing screws and bolts
- Length-optimised and ready to install

Connection	Cross-section mm ²	Length mm	Packs of	Model No.
M8	4	170	5 pc(s).	2564.000
M8	16	170	5 pc(s).	2565.000
M8	25	170	5 pc(s).	2566.000
M8	4	300	5 pc(s).	2567.000
M8	10	300	5 pc(s).	2565.120
M8	16	300	5 pc(s).	2568.000
M8	25	300	5 pc(s).	2569.000



Also required:

- Assembly parts for earth straps, see page 186



Earthing braid

Tin-plated copper, in various lengths and cross-sections with press-fitted contact rings. Earthing braids counteract the current displacement effect at high frequencies, whilst at the same time offering highly flexible connection opportunities.

- Approvals:**
- UR, cUR

Connection	Cross-section mm ²	Length mm	Packs of	Model No.
M8	16	200	10 pc(s).	2412.216
M8	25	200	10 pc(s).	2412.225
M8	16	300	10 pc(s).	2412.316
M8	25	300	10 pc(s).	2412.325



Also required:

- Assembly parts for earth straps, see page 186



Assembly parts

for earth straps

For fastening the earth straps and earthing braids to:

- Horizontal and vertical enclosure sections
- Punched section with mounting flange, 23 x 64 mm
- Punched section without mounting flanges, 23 x 64 mm
- Gland plates

Size	Packs of	Model No.
M8	10 pc(s).	2559.000



Also required:

- For mounting on horizontal and vertical enclosure sections: Cage nuts, see page 171



PE busbar

699 mm long PE busbar with 42 pre-fitted screws, including terminal clamps up to 6 mm² (fine wire conductors), 10 mm² (single wire or multi-wire conductors) and main terminal clamp up to 35 mm².

Packs of	Model No.
1 pc(s).	2364.000



Accessories:

- Cable retainer, see page 171

Contact washer

Serrated contact washers facilitate the secure connection of PE conductors, so there is no need to manually strip paint in the connection area.

Size	Packs of	Model No.
M8	100 pc(s).	2335.000

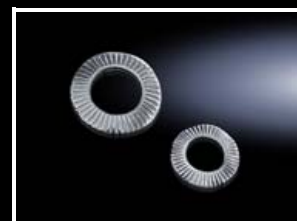

Central earthing point

For connecting
 – Earth straps
 – Earthing braids
 to the vertical and horizontal enclosure sections. The connection bracket is connected to the enclosure frame with 2 screws and is securely contacted. Earth connection is via the threaded bolt M8 x 20 mm.

Material:

- Sheet steel

Surface finish:

- Zinc-plated

Packs of	Model No.
1 pc(s).	7829.200

Supply includes:

- 1 connection bracket
- 2 assembly screws for mounting on the enclosure section
- 2 serrated washers
- 1 nut M8
- 1 contact lock washer M8
- 1 washer



ISV distribution enclosures

Installation kits



ISV installation kit

For mounting ISV installation modules in the enclosure.

Material:

- Mounting frame holder: Sheet steel, zinc-plated
- Contact hazard protection: Sheet steel, spray-finished
- Contact hazard protection, sides: PVC

Supply includes:

- Mounting aid support
- Contact hazard protection
- Assembly parts



Accessories:

- Cross rail, see page 195
- Mounting angle, see page 195
- Depth stay, see page 195
- Equipment support connector, see page 195

For enclosure width mm	600	600	850	1100
For enclosure height mm	1800	2000	2000	2000
For enclosure depth mm	400 500 600	400 500 600	400 600	400 600
To fit Model No.	8457.000/8684.000/ 8685.000/8686.000	8452.000/8604.000/ 8605.000/8606.000	9666.916/9666.956	9666.926/9666.966
Width units (WU) @ 250 mm	2	2	3	4
Height units (U) @ 150 mm	11	12	12	12
Note on Model No.	Additionally required: Mounting angle 9666.711 Mounting plate 8612.400	Additionally required: Mounting angle 9666.712 Mounting plate 8612.400	Additionally required: Mounting angle 9666.712 Mounting plate 8612.400	Additionally required: Mounting angle 9666.712 Mounting plate 8612.400 Depth stay 9666.732
VE	1 pc(s).	1 pc(s).	1 pc(s).	1 pc(s).
Model No.	9666.932	9666.902	9666.912	9666.922

ISV distribution enclosures

Installation modules

1 Contact hazard protection module

- For covering free installation areas
- Cover is prepared for a lead seal

Material:

- Cover: Polystyrene

Colour:

- RAL 7035

Supply includes:

- Assembly parts

2 Mounting plate module

- With mounting plate made from 2 mm zinc-plated sheet steel
- Cover is prepared for a lead seal
- Possible installation depth 105 – 140 mm

Size				Packs of	1 Contact hazard protection		2 Mounting plate	
Width unit		Height unit			Interior installation	Model No.	Mounting plate dimensions mm	Model No.
WU	mm	U	mm					
1	250	1	150	1 pc(s).	Empty module	9666.000	188 x 116	9666.080
1	250	2	300	1 pc(s).		9666.010	188 x 266	9666.090
1	250	3	450	1 pc(s).		9666.020	188 x 416	9666.100
1	250	4	600	1 pc(s).		9666.030	188 x 566	9666.110
2	500	1	150	1 pc(s).		9666.040	438 x 116	9666.120
2	500	2	300	1 pc(s).		9666.050	438 x 266	9666.130
2	500	3	450	1 pc(s).		9666.060	438 x 416	9666.140
2	500	4	600	1 pc(s).		9666.070	438 x 566	9666.150
3	750	2	300	1 pc(s).		9666.053	688 x 266	9666.133
3	750	3	450	1 pc(s).		9666.063	688 x 416	9666.143
3	750	4	600	1 pc(s).		9666.073	-	-

1 WU \pm 250 mm

1 U \pm 150 mm

1 Support rail module

- For installing terminal blocks, switchgear, etc.
- Support rails 35/15 mm
- Adjustable on a 25 mm pitch pattern
- Cover is prepared for a lead seal

Material:

- Cover: Polystyrene
- Support rail: sheet steel, zinc-plated

Colour:

- RAL 7035

Supply includes:

- Assembly parts

2 DIN rail mounted device module

- To accommodate DIN rail mounted devices
- Support rails 35/15 mm
- Cover is prepared for a lead seal



Accessories:

- Cover strips for DIN rail mounted device modules, see page 194
- Wiring bracket for support rails modules, see page 194

Size				Number of support rails	Packs of	1 Support rails		2 DIN rail mounted devices	
Width unit		Height unit				Model No.	Mechanical interior installation ¹⁾	Model No.	
WU	mm	U	mm						
1	250	1	150	1	1 pc(s).	9666.160	12 pitch units (1 x 12 x 18 mm)	9666.240	
1	250	2	300	2	1 pc(s).	9666.170	24 pitch units (2 x 12 x 18 mm)	9666.250	
1	250	3	450	3	1 pc(s).	9666.180	36 pitch units (3 x 12 x 18 mm)	9666.260	
1	250	4	600	4	1 pc(s).	9666.190	48 pitch units (4 x 12 x 18 mm)	9666.270	
2	500	1	150	1	1 pc(s).	9666.200	24 pitch units (2 x 12 x 18 mm)	9666.280	
2	500	2	300	2	1 pc(s).	9666.210	48 pitch units (4 x 12 x 18 mm)	9666.290	
2	500	3	450	3	1 pc(s).	9666.220	72 pitch units (6 x 12 x 18 mm)	9666.300	
2	500	4	600	4	1 pc(s).	9666.230	-	-	
3	750	2	300	2	1 pc(s).	9666.213	72 pitch units (6 x 12 x 18 mm)	9666.293	
3	750	3	450	3	1 pc(s).	9666.223	108 pitch units (9 x 12 x 18 mm)	9666.303	

1 WU \pm 250 mm

1 U \pm 150 mm

¹⁾ No. of fields x divider units x width



ISV distribution enclosures

Installation modules



Connection terminal block

- For connecting copper and aluminium conductors
- For laminated copper bars or solid and stranded conductors with a pressed wire end ferrule

Material:

- Duroplastic

Colour:

- RAL 7035

Supply includes:

- Assembly parts

Design	Connection of round conductors mm ²	Clamping area for laminated copper bars, (W x H) mm	Packs of	Model No.	Page
1 250 A, 5-pole	1 x 16 – 150 or 2 x 16 – 70	17 x 21	1 pc(s).	9666.340	
400 A, 5-pole	1 x 50 – 240 or 2 x 25 – 120	25 x 21	1 pc(s).	9666.350	

Also required

Description	Size				Packs of	Model No.	Page
	Width unit		Height unit				
	WU	mm	U	mm			
2 Mounting kit for connection terminal block	1	250	3	450	1 pc(s).	9666.310	
Contact hazard protection module	1	250	3	450	1 pc(s).	9666.020	189

1 WU $\hat{=}$ 250 mm
1 U $\hat{=}$ 150 mm

NH fuse-switch-disconnector module

- Suitable for accommodating NH fuse-switch disconnectors for mounting plate assembly
- Cover is prepared for a lead seal

Material:

- Cover: Polystyrene
- Cross member: Sheet steel

Colour:

- RAL 7035

Supply includes:

- Assembly parts

Note:

- Blanking cover 9666.665 should be used to seal unneeded cut-outs for NH fuse-switch disconnectors size 00.

To fit NH disconnector		Size				Packs of	Model No.	Page
Size	Model No.	Width unit		Height unit				
		WU	mm	U	mm			
2 pc(s), size 00	9344.000/.010/.020/.030/.040/.050	1	250	2	300	1 pc(s).	9666.380	
4 pc(s), size 00		2	500	2	300	1 pc(s).	9666.390	
1 pc(s), size 1	9344.100/.110/.130/.150	1	250	3	450	1 pc(s).	9666.400	
1 pc(s), size 2	9344.200/.210/.230/.250	1	250	3	450	1 pc(s).	9666.410	
1 pc(s), size 3 or 2 pc(s), size 2	9344.300/.310/.330/.350	2	500	3	450	1 pc(s).	9666.060 ¹⁾	189
						1 pc(s).	9666.420 ¹⁾	190

1 WU $\hat{=}$ 250 mm
1 U $\hat{=}$ 150 mm

¹⁾ Module unit consisting of disconnector cross-member 9666.420 and contact hazard protection module 9666.060

Disconnector cross-member for NH fuse-switch disconnector, size 2/3

- Suitable for accommodating NH fuse-switch disconnectors for mounting plate assembly

Material:

- Sheet steel

Supply includes:

- Assembly parts

To fit NH disconnector		Size				Packs of	Model No.	Page
Size	Model No.	Width unit		Height unit				
		WU	mm	U	mm			
1 pc(s), size 3 or 2 pc(s), size 2	9344.210/. 230/. 9344.210,230, 250.300/. 350	2	500	3	450	1 pc(s).	9666.420	

Also required

Contact hazard protection module	1 pc(s).	9666.060	189
----------------------------------	----------	----------	-----

ISV distribution enclosures

Installation modules

NH slimline fuse-switch-disconnector module

For NH slimline fuse-switch disconnectors, sizes 00 to 3 (100/185 mm bar centre distance).

Material:

- Cover: Polystyrene
- Holder: Fibreglass-reinforced plastic

Colour:

- RAL 7035

Supply includes:

- Assembly parts

Note:

- Busbars are not included with the supply
- To ensure problem-free cable connection, a contact hazard protection module or an N/PE busbar module must be installed above or below the NH slimline fuse-switch disconnector modules



Size				For size	To fit Model No.	For busbars mm	Bar centre distance mm	Packs of	Model No.
Width unit		Height unit							
WU	mm	U	mm						
1	250	3	450	3 x size 00	9346.020/ 9346.030	40 x 10	100	1 pc(s).	9666.570
2	500	3	450	6 x size 00	9346.020/ 9346.030	40 x 10	100	1 pc(s).	9666.580
2	500	5	750	8 x size 00 4 x size 1 4 x size 2 4 x size 3	9677.XXX	60 x 10	185	1 pc(s).	9666.550
3	750	3	450	10 x size 00	9346.020/ 9346.030	40 x 10	100	1 pc(s).	9666.583
3	750	5	750	12 x size 00 6 x size 1 6 x size 2 6 x size 3	9677.XXX	60 x 10	185	1 pc(s).	9666.560

Accessories

Contact hazard protection module	189
Busbar module N/PE	192

- 1 WU \triangleq 250 mm
1 U \triangleq 150 mm

Circuit-breaker module

- Suitable for accommodating standard circuit-breakers from ABB, Eaton, Schneider Electric and Siemens
- Cover is prepared for a lead seal

Material:

- Cover: Polystyrene
- Support rail: sheet steel, zinc-plated

Colour:

- RAL 7035

Note:

- Attachment of the circuit-breakers and the corresponding cut-out dimensions for the cover are shown in the enclosed assembly instructions
- Circuit-breakers are not included with the supply



For switchgear make	Size				Packs of	Model No.
	Width unit		Height unit			
	WU	mm	U	mm		
ABB (T1, T2, T3) Eaton (NZM1, NZM2, BZM B1, BZM B2) Schneider Electric (NSX100, NSX160, NSX250) Siemens (3RV13 53, VL160(X), VL250, VT1, VT2)	1	250	2	300	1 pc(s).	9666.430
ABB (T4, T5) Eaton (NZM3) Schneider Electric (NSX400, NSX630) Siemens (3RV1.6., 3RV1.7., VL400, VL630, VT3)	2	500	3	450	1 pc(s).	9666.440

- 1 WU \triangleq 250 mm
1 U \triangleq 150 mm

ISV distribution enclosures

Installation modules



Meter mounting board module

- Open module for internal measurements
- Clearance depth available for meter installation 170 mm

Material:

- Meter mounting board: Polystyrene
- Mounting rails: sheet steel, zinc-plated

Colour:

- RAL 7035

Supply includes:

- Assembly parts

Note:

- The meter mounting board module does not comply with meter mounting board standard DIN 43 870/VDE 0603 and does not meet the conditions for total insulation. Use in un-metered areas only by arrangement with the local electricity supply company.



Assembly

- 1 contact hazard protection module/DIN rail mounted device module or support rail module with 1 WU and at least 1 U is required both above and below the module.

Size				Packs of	Model No.	Page
Width unit		Height unit				
WU	mm	U	mm			
1	250	3	450	1 pc(s).	9666.640	

Also required

Contact hazard protection module	189
Support rail module	189
Serial installation device module	189
1 WU $\hat{=}$ 250 mm	
1 U $\hat{=}$ 150 mm	



Busbar module N/PE

- For attaching the busbars for N and PE
- Cover is prepared for a lead seal

Material:

- Cover: Polystyrene
- Holder: Fibreglass-reinforced plastic
- Support rail: sheet steel, zinc-plated

Colour:

- RAL 7035

Supply includes:

- Assembly parts

Note:

- Busbars are not included with the supply

For busbars mm	Size				Packs of	Model No.
	Width unit		Height unit			
	WU	mm	U	mm		
12 x 5 to 30 x 10 mm	1	250	2	300	1 pc(s).	9666.590
	2	500	2	300	1 pc(s).	9666.600
	3	750	2	300	1 pc(s).	9666.603

- 1 WU $\hat{=}$ 250 mm
- 1 U $\hat{=}$ 150 mm

ISV distribution enclosures

Installation modules

Busbar module

for fuse elements

For assembling bus-mounting fuse bases E18, E27, E33 and D-Switch as well as NH fuse-switch disconnectors, sizes 000 and 00 (3-pole, 60 mm bar centre distance).

Material:

- Cover: Polystyrene
- Holder: Fibreglass-reinforced plastic

Colour:

- RAL 7035

Supply includes:

- Assembly parts

Note:

- Busbars are not included with the supply



Size				To fit		Packs of	Model No.	Page
Width unit		Height unit		Fuse elements Model No.	NH disconnectors Model No.			
WU	mm	U	mm					
1	250	2	300	3418.010 3427.010 3433.010 9340.950	9343.000 ¹⁾ 9343.020 ¹⁾ 9343.040 ¹⁾ 3431.020 3431.030 3431.035	1 pc(s).	9666.520	
2	500	2	300		3431.020 3431.030 3431.035	1 pc(s).	9666.530	
3	750	2	300		3431.020 3431.030 3431.035	1 pc(s).	9666.533	

Accessories

Blanking cover	10 pc(s).	9666.660	194
----------------	-----------	----------	-----

¹⁾ WU ≥ 250 mm

¹⁾ U ≥ 150 mm

¹⁾ A depth extension frame 9666.680 should additionally be used to ensure unrestricted connection. NH fuse-switch disconnectors size 00 cannot be combined with other equipment.

ISV distribution enclosures

Accessories



Cover strips

for DIN rail mounted device module

For sealing unused component cut-outs in DIN rail mounted device modules, max. 12 pitch units (12 x 18 mm), divisible every 9 mm.

Material:

– ABS

Colour:

– RAL 7035

Packs of	Model No.
5 pc(s).	9666.650



Blanking cover

for busbar module

- For sealing unused cut-outs
- To fit bus-mounting fuse base, D-Switch and NH fuse-switch disconnecter size 000 (3-pole, 60 mm busbar systems) in busbar modules (9666.520/.530/.533)
- Width: 16 – 34 mm, variable.

Material:

– Polypropylene

Colour:

– RAL 7035

Packs of	Model No.
10 pc(s).	9666.660



Blanking cover

for NH fuse-switch-disconnector module

- For sealing unused cut-outs with NH fuse-switch disconnectors, size 00, in NH fuse-switch disconnector modules (9666.380/.390)
- Width 117 mm

Material:

– PVC

Colour:

– RAL 7035

Packs of	Model No.
1 pc(s).	9666.665



Wiring bracket

For tool-free attachment to the support rail 35/15 mm, for cable entry at the rear of support rail modules.

Material:

– Polyamide

Packs of	Model No.
10 pc(s).	9666.670



Depth extension frame

For extending the depth of the contact hazard protection cover. Allows unrestricted connection of NH fuse-switch disconnectors, size 00 (3-pole, 60 mm bar centre distance).

Material:

– Polystyrene

Colour:

– RAL 7035

Supply includes:

– Assembly parts

Size				Packs of	Model No.
Width unit		Height unit			
WU	mm	U	mm		
1	250	2	300	1 pc(s).	9666.680

1 WU \triangleq 250 mm

1 U \triangleq 150 mm

Note:

- NH fuse-switch disconnectors, size 00, with covers and depth extension frame cannot be used in conjunction with other equipment.

ISV distribution enclosures

Accessories

Cross rail

For horizontal sub-division of the support frame in the enclosure.

Material:

– Sheet steel

Surface finish:

– Zinc-plated

Width unit		Packs of	Model No.
WU	mm		
2	500	2 pc(s).	9666.722
3	750	2 pc(s).	9666.723
4	1000	2 pc(s).	9666.724

1 WU \triangleq 250 mm



Mounting angles

For vertical sub-division of the support frame in the enclosure.

Material:

– Sheet steel

Surface finish:

– Zinc-plated

Height unit		Packs of	Model No.
U	mm		
2	300	2 pc(s).	9666.702
3	450	2 pc(s).	9666.703
4	600	2 pc(s).	9666.704
5	750	2 pc(s).	9666.705
6	900	2 pc(s).	9666.706
7	1050	2 pc(s).	9666.707
11	1650	2 pc(s).	9666.711
12	1800	2 pc(s).	9666.712

1 U \triangleq 150 mm



Accessories:

– Equipment support connector, see page 195

Depth stay

for installation kits ISV

For attaching the installation kit in the enclosure.

Material:

– Sheet steel

Surface finish:

– Zinc-plated

For enclosure depth mm	Packs of	Model No.
400 500 600	2 pc(s).	9666.732



Equipment support connector

for mounting angles ISV

– For connecting 2 mounting angles

– Increases the stability of the frame structure

Material:

– T-section: Aluminium

Supply includes:

– Assembly parts

Packs of	Model No.
4 pc(s).	9666.740



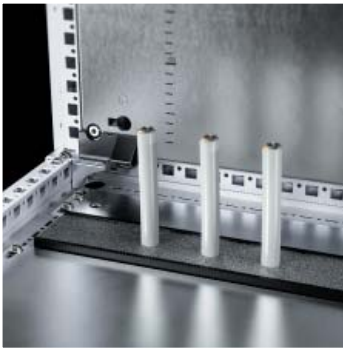

Gland plates

The modular base assembly allows completely flexible cable entry into the VX25, adapted to your individual requirements. Essential cable clamping takes place in the base/plinth area, directly above the insertion point, or on the mounting plate.



Cable duct

In addition to the DIN punchings, the mounting holes of Rittal cable ducts also have punchings on a 25 mm pitch pattern, completely eliminating the need for any machining. Components are simply screw-fastened into the round holes. The screw heads may be securely covered with an isolator cap for insulation purposes.

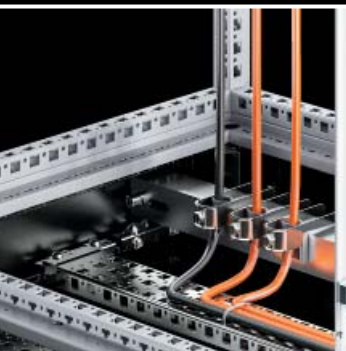

Cable clamping

Various cable clamping options are available and can be used identically both inside the enclosure and in the base/plinth. Relocating cable clamping into the base/plinth area frees up more mounting space inside the enclosure, rather than being lost to allow for bending radii.

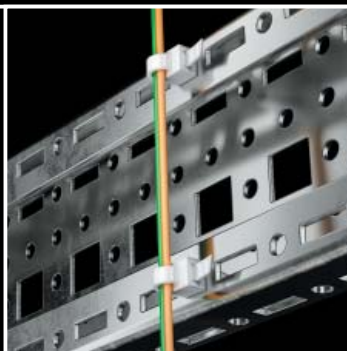

Cable ties

Simple, super-fast attachment of cables to all round holes on the enclosure and punched sections. Simply clip into position.



Cable entry on surfaces

There are a number of options available, from a simple stepped collar through to a sealing frame, which also allows the insertion of pre-assembled cables with connectors.



Cable conduit and cable conduit holder

Allows crush-proof cable routing to moving parts such as doors, with minimal assembly work.



Cable management

Cable entry



Cable entry plate

For

- Cable entry grommets
- Connector grommets

instead of segments from the standard divided gland plates

Material:

- Sheet steel

Surface finish:

- Zinc-plated

Protection category IP to IEC 60 529:

- IP55 in conjunction with cable entry grommets or connector grommets

Supply includes:

- Assembly parts

Enclosure width mm	Cut-outs per plate	Packs of	Model No.
600	6	2 pc(s).	8619.800
800	8	2 pc(s).	8619.801
1000	5	4 pc(s).	8619.802
1200	6	4 pc(s).	8619.803



Also required:

- Cable entry grommet, see page 198 or
- Connector grommet, see page 198

Three examples from a wide range of possibilities

The diagrams show three examples for positioning cable entry plates instead of segments from the three-piece gland plates supplied as standard. In this way, they can be positioned to fit the mounting plate.

Thanks to the enclosure symmetry, where dimensions permit, cable entry plates may also be inserted in the enclosure depth, right and left, analogous to the gland plates.

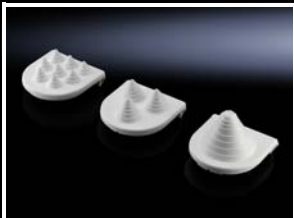
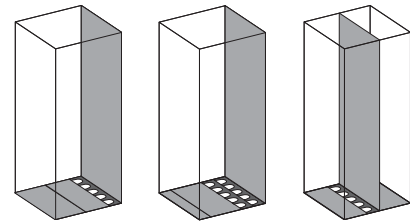

Cable entry grommets

In conjunction with the cable entry plate, supports simple, fast sealing of cables inserted into the base area of enclosures.

Material:

- Body: Polypropylene
- Cover: Thermoplastic elastomer

Protection category IP to IEC 60 529:

- IP55 if installed correctly

Cables per grommet	Max. Ø mm	Packs of	Model No.
8	13	25 pc(s).	4316.000
3	21	25 pc(s).	4317.000
1	47	25 pc(s).	4318.000

Connector grommets

Suitable for cable diameters from 8 to 36 mm.

Material:

- Outer cover: Polypropylene covered with thermoplastic elastomer
- Seal: cellular rubber

Protection category IP to IEC 60 529:

- IP55 if installed correctly

Packs of	Model No.
10 pc(s).	4311.000



Cable management

Cable entry

Section for cable entry, centre

For top-mounting on gland plates.

Material:

- Extruded aluminium section
- Seal: PU foam
- Cross-section: 30 x 25 mm

Protection category IP to IEC 60 529:

- IP55 if installed correctly

Supply includes:

- Plug-in sections, incl. foam rubber clamp strips

Note:

- You will need two pieces per cable entry point.
- From an enclosure width of 1000 mm, the base assembly is divided into two sections in the width. Two cable entry points (left/right) may be used.

For enclosure width mm	Packs of	Model No.
600	2 pc(s).	8618.800
800	2 pc(s).	8618.801
1000	4 pc(s).	8618.802
1200	4 pc(s).	8618.803



Accessories:

- Cable clamp rail, see page 204

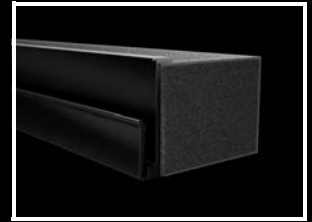

Section for cable entry, rear

For top-mounting on the gland plate and enclosure frame.

Material:

- Extruded aluminium section
- Seal: PU foam
- Cross-section: 30 x 25 mm

Protection category IP to IEC 60 529:

- IP55 if installed correctly

Supply includes:

- Plug-in sections, incl. foam rubber clamp strips

Note:

- You will need two pieces per cable entry point.
- From an enclosure width of 1000 mm, the base assembly is divided into two sections in the width. Two cable entry points (left/right) may be used.

For enclosure width mm	Packs of	Model No.
600	2 pc(s).	8618.810
800	2 pc(s).	8618.811
1000	4 pc(s).	8618.812
1200	4 pc(s).	8618.813



Accessories:

- Cable clamp rail, see page 204



Cable management

Cable gland



Cable gland, brass

Benefits:

- Because the gland and lock nut are sold together in a single pack, this saves additional ordering and storage
- Clamping membranes for even tightening and strain relief to protect the cables

Material:

- Brass
- Seal: CR/NBR

Surface finish:

- Nickel-plated

Protection category IP to IEC 60 529:

- IP68 (5 bar, 30 min.)

Approvals:

- VDE, UR, cUR

Size	Packs of	Model No.
M12 x 1.5	15 pc(s).	2411.801
M16 x 1.5	15 pc(s).	2411.811
M20 x 1.5	10 pc(s).	2411.821
M25 x 1.5	10 pc(s).	2411.831
M32 x 1.5	5 pc(s).	2411.841
M40 x 1.5	4 pc(s).	2411.851
M50 x 1.5	2 pc(s).	2411.861
M63 x 1.5	1 pc(s).	2411.871



Cable gland, polyamide

Benefits:

- Because the gland and lock nut are sold together in a single pack, this saves additional ordering and storage
- Clamping membranes for even tightening and strain relief to protect the cables

Material:

- Polyamide 6
- Seal: CR/NBR

Colour:

- RAL 7035

Protection category IP to IEC 60 529:

- IP68 (5 bar, 30 min.)

Approvals:

- VDE, UL, cUL, CSA, CSAus

Size	Packs of	Model No.
M12 x 1.5	50 pc(s).	2411.601
M16 x 1.5	50 pc(s).	2411.611
M20 x 1.5	50 pc(s).	2411.621
M25 x 1.5	25 pc(s).	2411.631
M32 x 1.5	15 pc(s).	2411.641
M40 x 1.5	5 pc(s).	2411.651
M50 x 1.5	5 pc(s).	2411.661
M63 x 1.5	3 pc(s).	2411.671

Cable management

Cable gland

Sealing frame, modular

For universal use on all surfaces and walls, for inserting pre-assembled cables with connectors. Can also be mounted onto 24-pole or 16-pole connector cut-outs.

Material:

- Plastic

Colour:

- Black

Protection category IP to IEC 60 529:

- IP66

Supply includes:

- Sealing frame
- Locking frame

Number of small seal inserts	For cut-out mm	Model No.
10	113.5 x 46 (24-pole)	2583.100
8	91 x 46 (16-pole)	2583.080



Also required:

- Inlay for plastic gland plates, modular and sealing frame, modular, see page 201
- Seal inserts for cable gland plates, modular and sealing frame, modular, see page 201



Inlay

for plastic gland plate, modular and sealing frame, modular

Individual inserts to subdivide the cut-outs in the modular plastic gland plate and the modular sealing frame.

Material:

- Plastic

Colour:

- Black

Design	Packs of	Model No.
1 slot	5 pc(s).	2582.100
2 slots	5 pc(s).	2582.200
4-way	5 pc(s).	2582.400
6 slots	5 pc(s).	2582.600

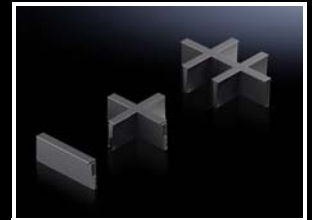

Seal inserts

for plastic gland plate, modular and sealing frame, modular

In conjunction with the inlays, the seal inserts allow individual cable entry, even with preassembled cables.

Material:

- Plastic

Colour:

- RAL 7035



Accessories:

- When using as a gland plate, modular: Locking clip for seal inserts, see Catalogue 36, page 1051

Seal inserts, small

For cable diameter	Packs of	Model No.
Solid	10 pc(s).	2580.000
3 mm	10 pc(s).	2580.003
4 mm	10 pc(s).	2580.004
5 mm	10 pc(s).	2580.005
6 mm	10 pc(s).	2580.006
7 mm	10 pc(s).	2580.007
8 mm	10 pc(s).	2580.008
9 mm	10 pc(s).	2580.009
10 mm	10 pc(s).	2580.010
11 mm	10 pc(s).	2580.011
12 mm	10 pc(s).	2580.012
13 mm	10 pc(s).	2580.013
14 mm	10 pc(s).	2580.014

Seal inserts, large

For cable diameter	Packs of	Model No.
Solid	5 pc(s).	2580.100
15 mm	5 pc(s).	2580.115
16 mm	5 pc(s).	2580.116
17 mm	5 pc(s).	2580.117
18 mm	5 pc(s).	2580.118
19 mm	5 pc(s).	2580.119
20 mm	5 pc(s).	2580.120
21 mm	5 pc(s).	2580.121
22 mm	5 pc(s).	2580.122
23 mm	5 pc(s).	2580.123
24 mm	5 pc(s).	2580.124
25 mm	5 pc(s).	2580.125

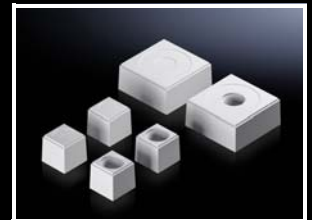

Cable management

Cable gland



Stepped collar

for wall thicknesses from 1.5 to 4.5 mm

For cable entry, simply cut off at the required level to match the cable diameter.

Material:

– Plastic to UL 94-HB

Protection category IP to IEC 60 529:

– IP54 with careful cable entry

For hole	Sealing range mm	Packs of	Model No.
M20	5 – 16	100 pc(s).	2899.200
M25	5 – 21	50 pc(s).	2899.250
M32	13 – 26.5	25 pc(s).	2899.320
M40	13 – 34	20 pc(s).	2899.400

Cable management

Cable duct

- With special DIN punchings for direct mounting on the enclosure section or on surfaces such as mounting plates.
- If the mounting plate is installed flush with the enclosure frame at the rear (installation position ± 0 mm), the horizontally mounted cable ducts are aligned with the cable ducts mounted on the enclosure section.
- Cable duct 50 mm wide for individually sited VX25 enclosures with side panel on the vertical section, on the left and right adjacent to the mounting plate.
- Cable duct 100 mm for mounting on the vertical enclosure frame with bayed enclosures.

Technical specifications:

- Depth: 80 mm
- Length: 2000 mm, may be cut to length
- Bar width: 5.5 mm
- Slot width: 4.5 mm

Material:

- Hard PVC
- Flame-resistant, self-extinguishing
- Temperature resistant to $+60$ °C

Width (B) mm	Packs of	Model No.
30	24 pc(s).	8800.750
40	20 pc(s).	8800.751
50	18 pc(s).	8800.755
60	18 pc(s).	8800.752
80	12 pc(s).	8800.753
100	12 pc(s).	8800.754

Colour:

- Similar to RAL 7030



Accessories:

- Metal multi-tooth screw 5.5 x 13 mm, see page 172
- Isolator cap, see page 203

- 1** = W 50 mm
- 2** = W 100 mm
- 3** = W 30 to 100 mm

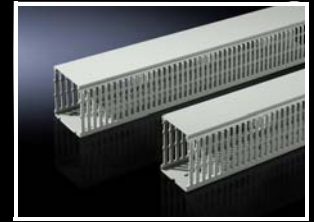
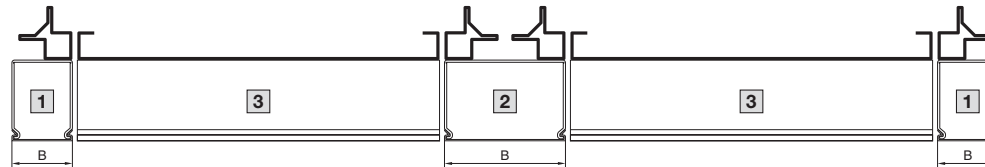

Isolator cap

for screw head

To isolate screw heads within the cable duct.

Material:

- Plastic

Packs of	Model No.
100 pc(s).	8800.770



Cable management

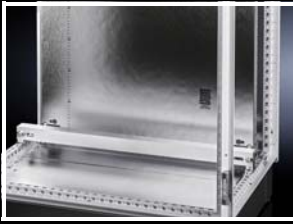

Cable clamp rail

Right angle section

For strain relief with cable entry. Depth-variable mounting on a 25 mm pitch pattern on the horizontal enclosure section or in the base/plinth.

Material:

- Steel

Surface finish:

- Zinc-plated

Supply includes:

- Assembly parts

Enclosure width mm	Packs of	Model No.
400	2 pc(s).	8619.400
600	2 pc(s).	8619.410
800	2 pc(s).	8619.420
1000	2 pc(s).	8619.430
1200	2 pc(s).	8619.440
1600	2 pc(s).	8619.450
1800	2 pc(s).	8619.460



Accessories:

- Base/plinth installation bracket, see page 93



Cable clamp

for cable clamp rails

For fastening the cables to the cable clamp rails.

Material:

- Sheet steel

Surface finish:

- Zinc-plated

Supply includes:

- Plastic insert

For cable diameter mm	Packs of	Model No.
6 - 12	25 pc(s).	2350.000
12 - 16	25 pc(s).	2351.000
14 - 18	25 pc(s).	2352.000
18 - 22	25 pc(s).	2353.000
22 - 26	25 pc(s).	2354.000
26 - 30	25 pc(s).	2355.000
30 - 34	25 pc(s).	2356.000
34 - 38	25 pc(s).	2357.000
38 - 42	25 pc(s).	2358.000
42 - 46	25 pc(s).	2359.000
46 - 50	25 pc(s).	2360.000



Possible alternative:

- Rail for EMC shielding bracket and strain relief, see page 182



Cable clamp rail

C rail, for mounting plates

For strain relief with cable entry. The length of the cable clamp rail is tailored to the width of the mounting plate. The mounting bracket included with the supply supports three different installation situations on the mounting plate:

- 1 Straight, at a distance of 23 mm from the mounting plate
- 2 Straight, at a distance of 10 mm from the mounting plate
- 3 Tilted towards the mounting plate

Material:

- Sheet steel

Surface finish:

- Zinc-plated

Supply includes:

- Two mounting brackets and assembly screws

For enclosure width mm	Length mm	Packs of	Model No.
600	499	1 pc(s).	5001.080
800	699	1 pc(s).	5001.081
1000	899	1 pc(s).	5001.082
1200	1099	1 pc(s).	5001.083



Accessories:

- Cable clamps for C rails, see page 205

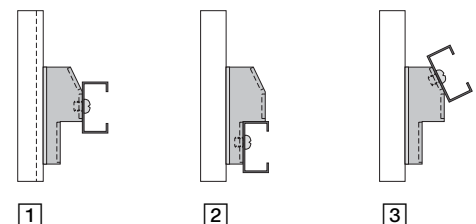

Cable management

Cable clamp

for C rail

For attaching cables to the C rail.

Material:

– Sheet steel

Surface finish:

– Zinc-plated

Supply includes:

– Plastic insert

For cable diameter mm	Packs of	Model No.
6 – 14	25 pc(s).	7077.000
12 – 18	25 pc(s).	7078.000
18 – 22	25 pc(s).	7097.000
22 – 26	25 pc(s).	7097.220
26 – 30	25 pc(s).	7097.260
30 – 34	25 pc(s).	7097.300
34 – 38	25 pc(s).	7097.340
38 – 42	25 pc(s).	7098.000
42 – 56	25 pc(s).	7098.100
56 – 64	25 pc(s).	7099.000



Accessories:

– C rail, see from page 167

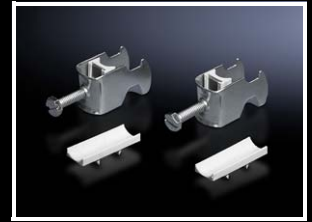

Cable conduit and cable conduit holder

For secure cable routing e.g. from the enclosure or mounting plate to the door. An attachment facility for standard commercially available cable ties is provided on the cable conduit holder, so that cables may be attached upon entry to/exit from the cable conduit.

Material:

– Cable conduit: Polyethylene
– Cable conduit holder: Polyamide

Cable conduit

Internal Ø mm	Packs of	Model No.
16	25 m	2595.000
29	25 m	2589.000
36	25 m	2596.000
48	25 m	2590.000

Cable conduit holder

For cable conduit Ø mm	Packs of	Model No.
16	20 pc(s).	2593.000
29	20 pc(s).	2591.000
36	20 pc(s).	2594.000
48	20 pc(s).	2592.000



Cable tie

The super-fast solution for fastening cables to the enclosure profile or mounting system parts. Simply clip into the round system punchings.

Length mm	Packs of	Model No.
150	100 pc(s).	2597.000



482.6 mm (19") installation system

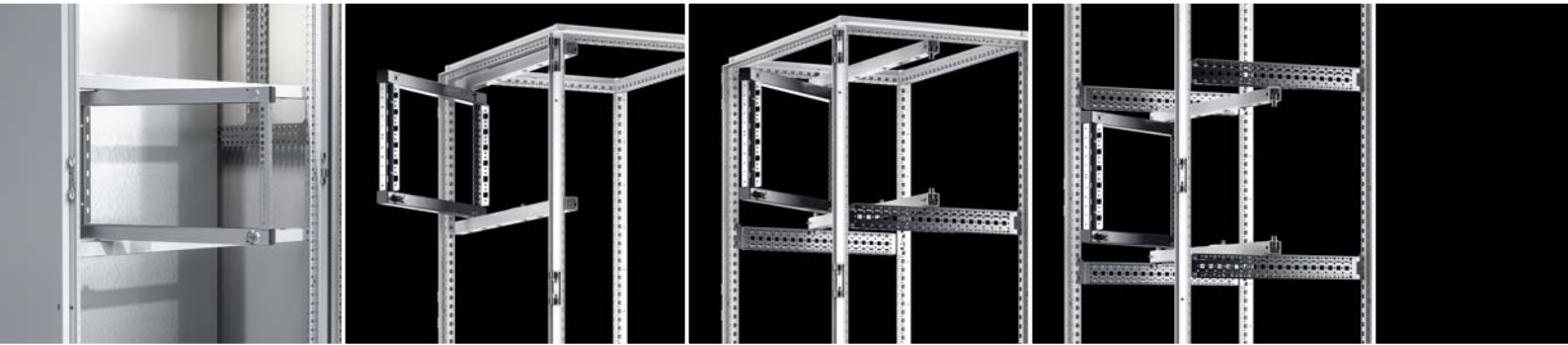

Swing frame, large
The swing frame, large, supports full or partial installation for 482.6 mm (19") components. It is fully depth-adjustable within the 25 mm pitch pattern, and hinged on the left or right. Two swing frames may also be fitted together in 1200 mm wide enclosures. An opening angle of 180° is also supported with a special hinge.



Swing frame stay
With the swing frame stay, even enclosures with heavy installed equipment can be held securely in position during maintenance work. The stay can be fitted at the top or bottom of the enclosure.

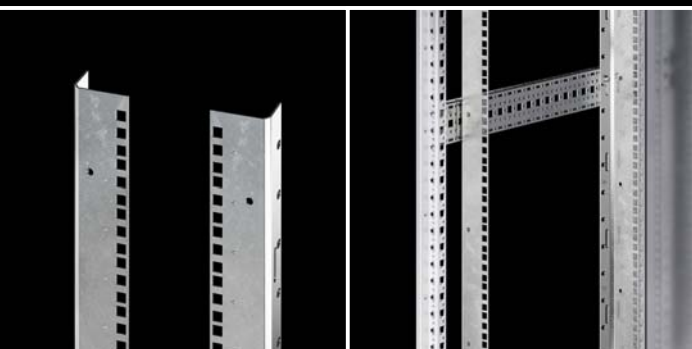

Adaptor section, 482.6 mm (19")
Turns any 600 mm wide VX25 into an electronic enclosure. The 482.6 mm (19") sections may be attached directly to the enclosure section or adjusted in the depth on a 25 mm pitch pattern on punched sections with mounting flanges. The sections may be shortened to any length for partial installation.

482.6 mm (19") installation system

Swing frame, small

The swing frame, small, is the ideal solution for partial installation with 482.6 mm (19") components. It can be positioned anywhere you like in the height and depth of the enclosure within the 25 mm pitch pattern, and is fitted in a flash.

Fastener

The 482.6 mm (19") fastener allows you to create attachment facilities for 482.6 mm (19") components in next to no time, without the need for time-consuming installation of individual cage nuts. Components are simply snap-mounted onto the 482.6 mm (19") mounting angle.

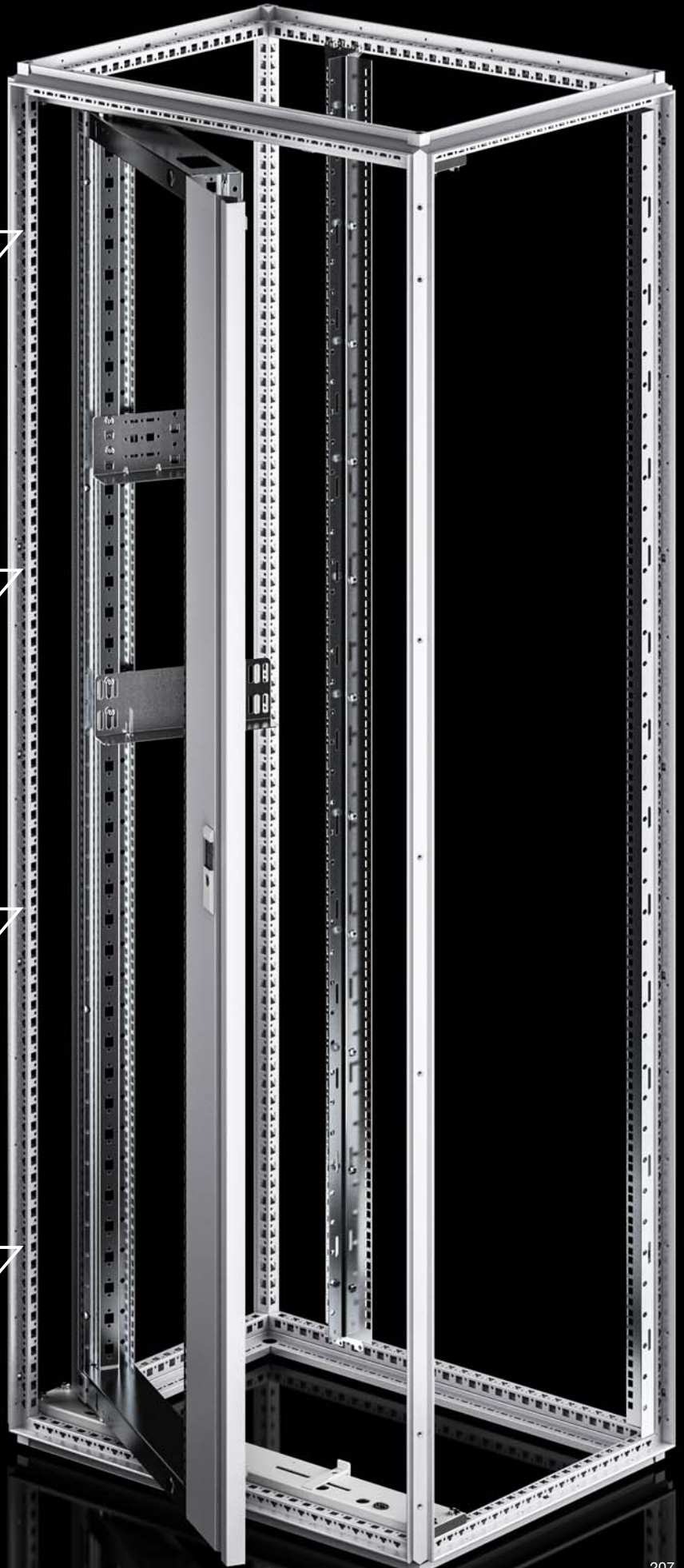

482.6 mm (19") installation system

Swing frame



Swing frame, small

for 600 and 800 mm wide enclosures

For mounting 482.6 mm (19") equipment.

Material:

– Sheet steel

Surface finish:

– Zinc-plated

Supply includes:

– Cam with double-bit lock insert, 2 x 130° hinge, and parts for attaching to the installation kit

Note:

– The swing frame stay is 8619.270 required to lock the open swing frame, see page 210



Accessories:

– 482.6 mm (19") fastener, 1 U, see page 212

Installation	Front, top/bottom	Set back, top/bottom	Set back, front, centre
U	Packs of	Model No.	
3	1 pc(s).	8619.500	
6	1 pc(s).	8619.510	
9	1 pc(s).	8619.520	
12	1 pc(s).	8619.530	
15	1 pc(s).	8619.540	
18	1 pc(s).	8619.550	

Also required:

[1] Installation kit	for enclosure width	1 pc(s).	for enclosure width		Page
			600	800	
			8619.600	8619.610	208
[2] Punched section with mounting flange 23 x 64 mm, 2 or 4 pc(s) required	for enclosure depth mm				
	400	4 pc(s).	8617.110		164
	500	4 pc(s).	8617.120		164
	600	4 pc(s).	8617.130		164
	800	4 pc(s).	8617.140		164



Installation kit

for swing frame, small, and partial mounting plate

- For mounting the swing frame, small or a partial mounting plate (in conjunction with a hinge for partial mounting plates)
- Directly on the enclosure section in the foremost position
- In conjunction with punched section with mounting flange 23 x 64 mm, offset in the depth

Load capacity:

– Up to 1500 N

Material:

– Sheet steel

Surface finish:

– Nickel-plated

Supply includes:

– Assembly parts

For enclosure width mm	Packs of	Model No.
600	1 pc(s).	8619.600
800	1 pc(s).	8619.610

482.6 mm (19") installation system

Swing frame

Swing frame, large

for 600, 800 and 1200 mm wide enclosures

For mounting 482.6 mm (19") equipment.

Material:

- Sheet steel

Surface finish:

- Frame: Zinc-plated
- Trim panels: Spray finished

Colour:

- Trim panels: RAL 7035

Supply includes:

- Lock system, 130° hinge and parts for attaching to the installation kit

Note:

- The swing frame stay is required to lock the open swing frame, see page 210



Accessories:

- 482.6 mm (19") fastener, 1 U, see page 212

Installation options

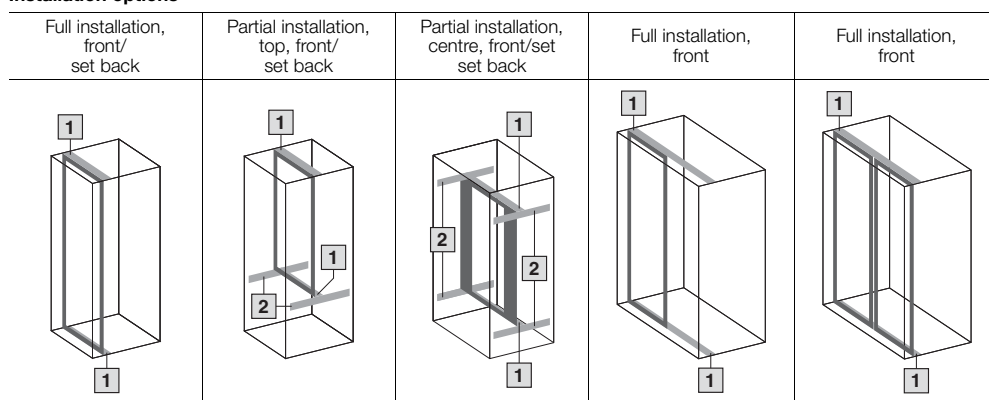

Trim panel			Without	One side	Both sides	Page
For enclosure width mm			600	800	800	
U	For min. enclosure height mm	Packs of	Model No.			
22	1200	1 pc(s).	8619.010	8619.020	8619.030	
31	1600	1 pc(s).	8619.011	8619.021	-	
35	1800	1 pc(s).	8619.012	8619.022	8619.032	
40	2000	1 pc(s).	8619.013	8619.023	8619.033	
44	2200	1 pc(s).	8619.014	8619.024	8619.034	
Lock system		Cam lock	■	-	-	
		Locking rod	-	■	■	

Also required:

	For enclosure width mm	Packs of				
1 Installation kit	600	1 pc(s).	8619.040	-	-	210
	800	1 pc(s).	8619.041	8619.041	8619.041	210
	1200	1 pc(s).	8619.042	8619.042	8619.042	210
2 Punched section with mounting flange 23 x 64 mm, 2 or 4 pc(s) required	Installation in enclosure depth mm					
	400	4 pc(s).	8617.110	8617.110	8617.110	164
	500	4 pc(s).	8617.120	8617.120	8617.120	164
	600	4 pc(s).	8617.130	8617.130	8617.130	164
	800	4 pc(s).	8617.140	8617.140	8617.140	164

Accessories

Comfort handle AX			-	see page	see page	131
Lock inserts	Type A		-	see page	see page	131
180° hinge 1)		1 pc(s).	8619.051	8619.051	8619.051	210

1) Only in conjunction with 800 mm wide installation kit.



482.6 mm (19") installation system

Swing frame



Installation kit

for swing frame, large

For mounting:

- Directly on the enclosure section when installed across the entire enclosure height
- In conjunction with punched section with mounting flange 23 x 64 mm, for partial installation in the enclosure height

Material:

- Sheet steel, 3 mm

Surface finish:

- Spray-finished

Colour:

- RAL 7035

Supply includes:

- Assembly parts

For enclosure width mm	Load capacity N	Packs of	Model No.
600	3500	1 pc(s).	8619.040
800	3500	1 pc(s).	8619.041
1200	1500	1 pc(s).	8619.042



Swing frame stay

Secures the swing frame in the open position.

For mounting on swing frame, large:

- 8619.270 at the top of the enclosure
- 1980.200 at the bottom of the enclosure (with safety stop at 160°)

	Packs of	Model No.
For 130° hinge	1 pc(s).	8619.270
For 180° hinge	1 pc(s).	1980.200



For mounting on swing frame, small:

- 8619.270, may be mounted at the top on the installation kit



180° hinge

for swing frame, large

- To extend the opening angle from 130° to 180° in the foremost installation position
- Provides optimum access to the components and 482.6 mm (19") components located behind the swing frame

Load capacity:

- Up to 1500 N

Material:

- Die-cast

Packs of	Model No.
1 pc(s).	8619.051



Slide rail

for swing frames

To support heavy slide-in 482.6 mm (19") electronic equipment in the swing frame.

Material:

- Sheet steel

Surface finish:

- Zinc-plated

For slide-in equipment with max. installation depth	Packs of	Model No.
< 190 mm	10 pc(s).	1962.200
> 190 mm	10 pc(s).	1963.200

482.6 mm (19") installation system

Mounting angles

Adaptor section, 482.6 mm (19")

For mounting electronic components, subracks and other 482.6 mm (19") equipment. Adaptor sections are easily shortened for partial assemblies.

Material:

- Sheet steel, 2 mm

Supply includes:

- Assembly parts

Note:

- The 482.6 mm (19") measurement is obtained when mounting on the frame for 600 mm wide enclosures
- Depth-offset installation in 600 mm wide enclosures is possible using punched sections with mounting flanges, 18 x 64 mm

For enclosure height mm	U	Packs of	Model No.
1600	33	2 pc(s).	8619.300¹⁾
1800	38	2 pc(s).	8619.310
2000	42	2 pc(s).	8619.320¹⁾

¹⁾ For the rear of electronic enclosures, see page 68



Accessories:

- 482.6 mm (19") fastener, 1 U, see page 212
- Slide rail VX for adaptor section 482.6 mm (19") with attachment on one side, see page 212
- Slide rail VX for adaptor section 482.6 mm (19") with attachment on both sides, see page 212
- Punched section with mounting flange, 18 x 64 mm, see page 164
- Multi-tooth screws, see page 172
- Metal multi-tooth screws, see page 172
- Self-tapping screws, see page 172

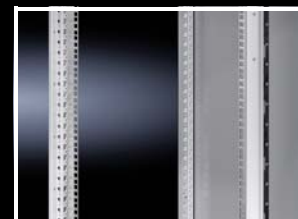

Installation examples for VX

Foremost installation position

In conjunction with sheet steel door

In conjunction with glazed door

Offset installation position

May be depth-mounted on a 25 mm pitch pattern on punched sections with mounting flanges

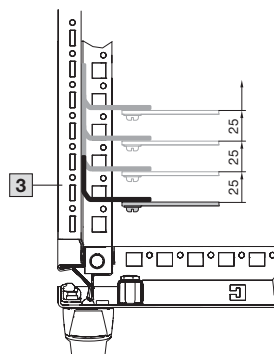
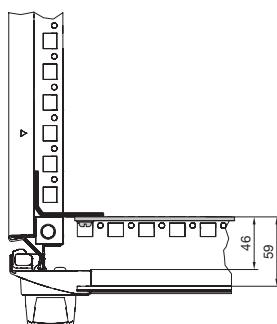
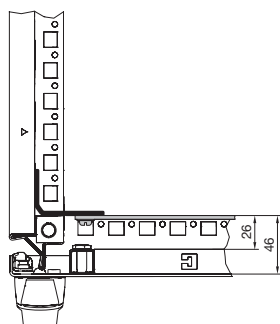

Adaptor piece, 482.6 mm (19")

The 1 U sub-section of adaptor sections. For the installation of subracks and other 482.6 mm (19") equipment.

Material:

- Sheet steel, 2 mm

Supply includes:

- Assembly parts

Note:

- The 482.6 mm (19") measurement is obtained when mounting on the frame for 600 mm wide enclosures
- Depth-offset installation in 600 mm wide enclosures is possible using punched sections with mounting flanges, 18 x 64 mm

U	Packs of	Model No.
1	4 pc(s).	8619.330



Accessories:

- 482.6 mm (19") fastener, 1 U, see page 212
- Punched section with mounting flange, 18 x 64 mm, see page 164
- Multi-tooth screws, see page 172
- Metal multi-tooth screws, see page 172
- Self-tapping screws, see page 172

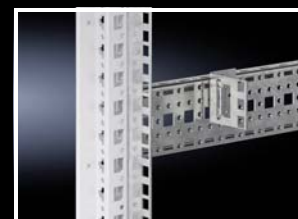

482.6 mm (19") installation system

Mounting angles



Slide rail VX

for adaptor section 482.6 mm (19") with attachment on both sides

Mounting between the 482.6 mm (19") front and rear adaptor sections or 482.6 mm (19") adaptor pieces.

Material:

- Sheet steel

Surface finish:

- Zinc-plated

Supply includes:

- Assembly parts

For enclosure depth mm	Packs of	Model No.
500	10 pc(s).	8613.151
600	10 pc(s).	8613.161
800	10 pc(s).	8613.181



Slide rail VX

for adaptor section 482.6 mm (19") with attachment on one side

Mounted on the adaptor section, 482.6 mm (19").

Material:

- Sheet steel

Surface finish:

- Zinc-plated

Supply includes:

- Assembly parts

Length mm	Packs of	Model No.
270	10 pc(s).	4531.001



482.6 mm (19") fastener, 1 U with contact

For simple screw connection of installation components within the 482.6 mm (19") mounting level. Simply slide onto the mounting angle from the inside and lock home.

Benefits:

- Fast positioning and installation instead of using individual cage nuts
- Integral contacting for potential equalisation
- Preconfigured 1 U support with 3 cage nuts, including centre attachment to standard EIA 310
- Supports multiple dismantling and reuse

Material:

- Sheet steel, zinc-plated

Thread	Packs of	Model No.
M5	24 pc(s).	2090.000



Also required:

- Multi-tooth screws 7094.130, see page 212

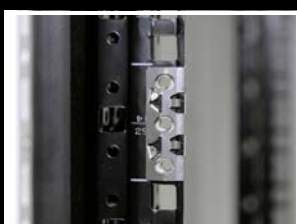

Multi-tooth screw

M5 x 16 mm

For optimum transmission of torques, an extended tool life, and enhanced safety and reliability when tightening and loosening screw connections.

Supply includes:

- 50 plastic washers
- 50 assembly screws

	Bit size	Packs of	Model No.
M5	Multi-tooth 25	50 pc(s).	7094.130

The 3-phase coating procedure

Coating procedure	Technical properties	Technical specifications	
Degreasing, nanoceramic pretreatment, rinsing	Used as corrosion protection and to improve paint adhesion.	Nanoceramic conversion layer	
Interior/exterior: Anodic dipcoat priming	Even layer formation on all surfaces, edges and in cavities, which produces a high level of corrosion protection even at the assembly stage. The primer is readily overpainted and free from heavy metals, chromate and silicone.	Erichsen cupping test to DIN EN ISO 1520	≥ 4 mm
		Buchholz hardness to DIN EN ISO 2815	≥ 80
		Cross cutting to DIN EN ISO 2409	Gt 0
Stove enamelling			
Exterior: Textured powder coating	Powder-coating is distinguished by a high level of mechanical resistance, excellent corrosion protection, good resistance to chemicals and temperature, and its facility for decontamination. The powder coating is readily overpainted and is free from heavy metals, chromate and silicone.	Erichsen cupping test to DIN EN ISO 1520	≥ 3.5 mm
		Buchholz hardness to DIN EN ISO 2815	≥ 80
		Cross cutting to DIN EN ISO 2409	Gt 0
		Salt spray test to DIN EN ISO 9227 NSS	Test period: 168 hours
		Condensate test to DIN EN ISO 6270-2 CH	Test period: 500 hours
		Condensate test to DIN EN ISO 6270-2 AHT	Test period: 20 cycles
Stove enamelling			

The coating is resistant to:

- Mineral oils
- Lubricants
- Machine emulsions
- Alcohol-based solvents (briefly, e.g. during cleaning)
- Weak acids and alkalines

Primer or powder coating suitable for overpainting

After careful cleaning of the surface, the standard coating may be overpainted with:

- DD gloss paints
- Single and dual-component gloss paints
- Car repair paints
- Powder paints
- Water-based paints

If in doubt, perform a compatibility test. Always follow the paint manufacturer's instructions. When overpainting, take care not to exceed 180 °C and a baking time of 15 minutes.

Outdoor use of enclosures

In order to guarantee satisfactory long-term function of enclosures in outdoor use, the relevant environmental factors must be taken into account.

These include:

- UV radiation, the corrosive action of air pollution, rain, icing, snow, wind or other factors in special climatic conditions.

Condensation inside the enclosure

Condensation must be prevented by means of appropriate measures, e.g. by venting or heating the enclosure.

Protection category

The enclosure may be exposed to extreme weather conditions during outdoor use. Long periods of rain, snow, ice, high winds and temperature fluctuations place particularly high demands on the enclosure sealing. The protection category IPX3 as envisaged for external weather conditions in DIN VDE 0100, part 737, point 5.2 is often insufficient to provide permanent protection for electrical equipment.

Protection categories to IEC 60 529 (EN 60 529)

The IP protection category is characterised by 2 numerals.

Example of a protection category, e.g. IP43:

Code letters

IP

First numeral

4

Second numeral

3

Degrees of protection for protection against contact and foreign bodies: First numeral			Degrees of protection for protection against water: Second numeral		
First numeral	Degree of protection		Second numeral	Degree of protection	
	Designation	Explanation		Designation	Explanation
1	Protected against solid foreign objects with a diameter of 50 mm and greater	The object probe, a sphere 50 mm in diameter, must not penetrate fully. ¹⁾	1	Protected against vertically falling water drops	Vertically falling drops shall have no harmful effects.
2	Protected against solid foreign objects with a diameter of 12.5 mm and greater	The object probe, a sphere 12.5 mm in diameter, must not penetrate fully. ¹⁾ The articulated test finger may penetrate up to its length of 80 mm, but adequate distance from hazardous parts must be adhered to.	2	Protected against vertically falling water drops when the enclosure is tilted up to 15°	Vertically falling drops shall not have any harmful effects when the enclosure is tilted up to 15° on either side of the vertical.
3	Protected against solid foreign objects with a diameter of 2.5 mm and greater	The object probe, a sphere 2.5 mm in diameter, must not penetrate at all ¹⁾ .	3	Protected against sprayed water	Water sprayed at an angle of up to 60° on either side of the vertical shall have no harmful effects.
4	Protected against solid foreign objects with a diameter of 1.0 mm and greater	The object probe, a sphere 1.0 mm in diameter, must not penetrate at all ¹⁾ .	4	Protected against splashed water	Water splashed on the enclosure from any direction shall have no harmful effects.
5	Dust-protected	The ingress of dust is not fully prevented, but dust shall not enter to such an extent as to impair satisfactory operation of the device or safety.	5	Protected against water jets	Water directed at the enclosure from any direction in a jet shall have no harmful effects.
6	Dust-tight	No ingress of dust at a partial vacuum of 20 mbar inside the enclosure.	6	Protected against powerful water jets	Water directed at the enclosure from every direction in a powerful jet shall have no harmful effects.
			7	Protected against temporary immersion in water	Water must not ingress to such an extent as to cause harmful effects when the enclosure is temporarily immersed in water under standardised pressure and time conditions.
			8	Protected against continuous immersion in water	Ingress of water in quantities causing harmful effects shall not be possible when the enclosure is continuously immersed in water under conditions to be agreed between the manufacturer and the user. However, the conditions must be more difficult than for numeral 7.
			9	Protected against high-pressure and high-temperature water jets	Water projected at high pressure and high temperature against the enclosure from any direction shall not have harmful effects.

¹⁾ The full diameter of the object probe must not pass through an opening of the enclosure.

NEMA

The **N**ational **E**lectrical **M**anufacturers **A**ssociation (NEMA) is a standards organisation in Washington, USA, which publishes a number of technical standards but does not test or certify products itself.

The following NEMA classification outlines the protection of individuals from accidental contact with equipment and the protection of an enclosure from external factors.

Further information on protection categories may be found on the Internet at: www.rittal.com

UL/NEMA Type	Intended use and description
1	Enclosures for use predominantly indoors Protection against the penetration of foreign bodies
3	Enclosures for use predominantly outdoors Protection from rain, hail, dust, icing and the damage caused by icing
3R	Enclosures for use predominantly outdoors Protection from rain, hail, icing and the damage caused by icing
3S	Enclosures for use predominantly outdoors Protection from rain, hail and dust External mechanisms remain usable despite being coated in ice
4	Enclosures for indoor or outdoor use Protection against rain, foreign bodies, splashed water and hosed water and against damage caused by icing on the exterior of the enclosure
4X	Enclosures for indoor or outdoor use Protection against rain, foreign bodies, splashed water and hosed water and against damage caused by icing on the exterior of the enclosure Increased protection from corrosion.
12, 12K	Enclosures for use predominantly indoors Protection against dust deposits, foreign bodies and non-corrosive dripping liquids
13	Enclosures for use predominantly indoors Protection against dust deposits, sprayed water, oil, and non-corrosive coolants

The UL/NEMA classifications are not directly comparable with IP protection categories, since both the test conditions and the evaluation of the test results are different.

Approvals and permits

Product certifications and approvals are pivotal to the global acceptance of industrial products. Rittal products meet the highest internationally recognised quality yardsticks. All components are subjected to the most stringent testing in accordance with international standards and regulations. The consistently high product quality is ensured by a comprehensive quality management system. Regular production inspections by external test institutes also guarantee compliance with global standards

A precise allocation of products to marks of conformity can be found on our product and service pages on the Internet at www.rittal.com

PE conductor connection

The PE conductor connection must be designed by the manufacturer of switchgear in accordance with the relevant VDE and/or local regulations. The enclosure packs generally contain earthing materials (screws, nuts, washers). The assembly instructions contain recommendations on installing a PE conductor. The pre-assembled earth straps, available as accessories in various cross-sections and lengths, are intended to make assembly of a PE conductor easier.

Further information can be found in our technical documentation "PE conductor connection, current carrying capacity".

Baying enclosure system VX25

Technical details

Basic enclosure

Sheet steel, stainless steel

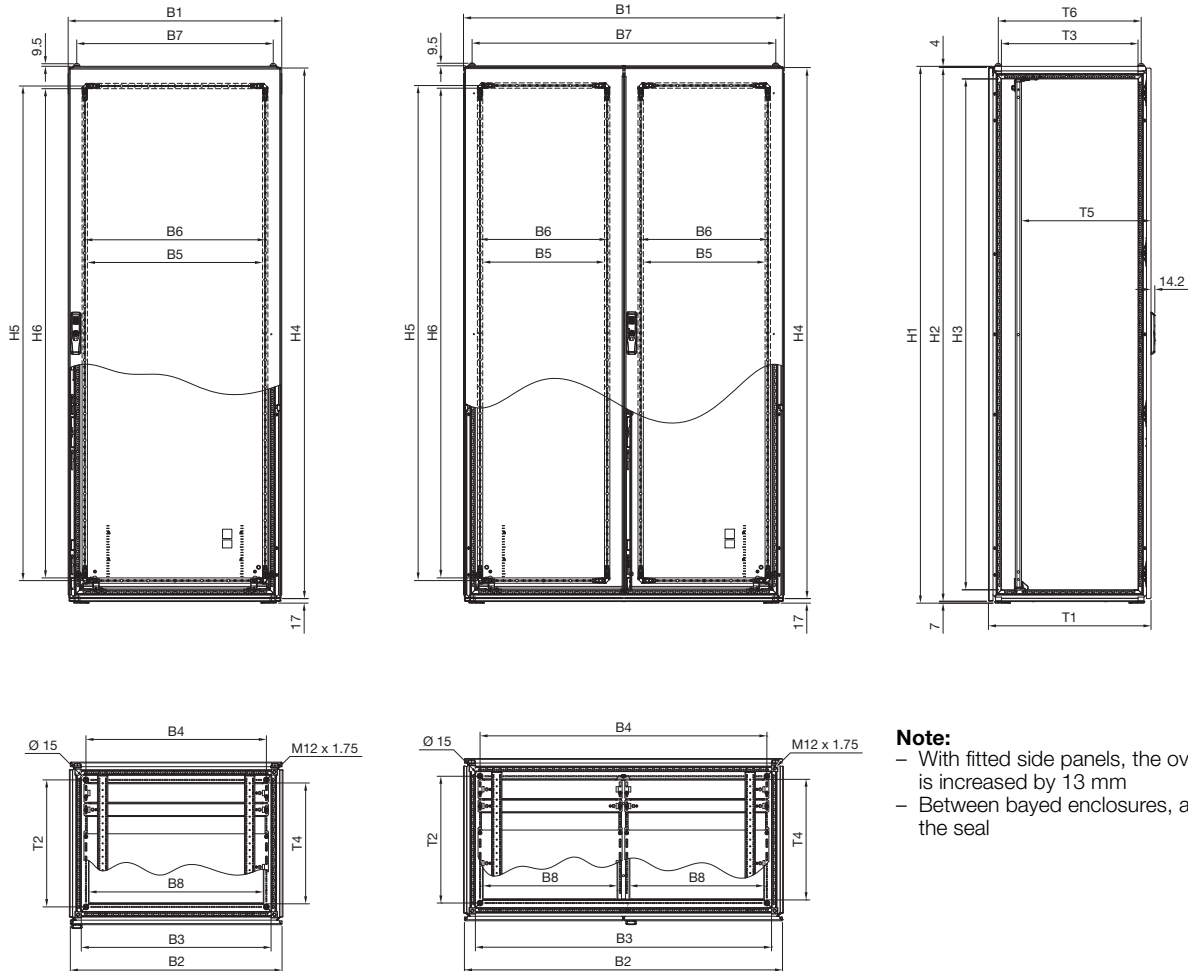

Note:
 - With fitted side panels, the overall width (B1) is increased by 13 mm
 - Between bayed enclosures, allow 1 mm for the seal

Two-door

Model No.		Width dimensions mm								Height dimensions mm						Depth dimensions mm						Mounting plate	
Spray-finished	Stainless steel	B1	B2	B3	B4	B5	B6	B7	B8	H1	H2	H3	H4	H5	H6	T1	T2	T3	T4	T5	T6	F	G
8004.000	-	999	992	911	875	355	375	935	402	2008	1997	1911	1985	1850	1830	408	275	311	252	132 - 357	335	899	1896
8005.000	-	999	992	911	875	355	375	935	402	2008	1997	1911	1985	1850	1830	508	375	411	352	132 - 457	435	899	1896
8006.000	-	999	992	911	875	355	375	935	402	2008	1997	1911	1985	1850	1830	608	475	511	452	132 - 557	535	899	1896
8080.000	-	999	992	911	875	355	375	935	402	1808	1797	1711	1785	1650	1630	408	275	311	252	132 - 357	335	899	1696
8204.000	-	1199	1192	1111	1075	455	475	1135	502	2008	1997	1911	1985	1850	1830	408	275	311	252	132 - 357	335	1099	1896
8205.000	-	1199	1192	1111	1075	455	475	1135	502	2008	1997	1911	1985	1850	1830	508	375	411	352	132 - 457	435	1099	1896
8206.000	8451.000	1199	1192	1111	1075	455	475	1135	502	2008	1997	1911	1985	1850	1830	608	475	511	452	132 - 557	535	1099	1896
8208.000	-	1199	1192	1111	1075	455	475	1135	502	2008	1997	1911	1985	1850	1830	808	675	711	652	132 - 757	735	1099	1896
8215.000	-	1199	1192	1111	1075	455	475	1135	502	1208	1197	1111	1185	1050	1030	508	375	411	352	132 - 457	435	1099	1096
8226.000	-	1199	1192	1111	1075	455	475	1135	502	2208	2197	2111	2185	2050	2030	608	475	511	452	132 - 557	535	1099	2096
8245.000	-	1199	1192	1111	1075	455	475	1135	502	1408	1397	1311	1385	1250	1230	508	375	411	352	132 - 457	435	1099	1296
8265.000	-	1199	1192	1111	1075	455	475	1135	502	1608	1597	1511	1585	1450	1430	508	375	411	352	132 - 457	435	1099	1496
8284.000	8456.000	1199	1192	1111	1075	455	475	1135	502	1808	1797	1711	1785	1650	1630	408	275	311	252	132 - 357	335	1099	1696
8285.000	8453.000	1199	1192	1111	1075	455	475	1135	502	1808	1797	1711	1785	1650	1630	508	375	411	352	132 - 457	435	1099	1696
8286.000	-	1199	1192	1111	1075	455	475	1135	502	1808	1797	1711	1785	1650	1630	608	475	511	452	132 - 557	535	1099	1696
8880.000	-	799	792	711	675	255	275	735	652	1808	1797	1711	1785	1650	1630	508	375	411	352	132 - 457	435	699	1696
8881.000	-	799	792	711	675	255	275	735	652	1808	1797	1711	1785	1650	1630	608	475	511	452	132 - 557	535	699	1696

Baying enclosure system VX25

Technical details

Basic enclosure with glazed door

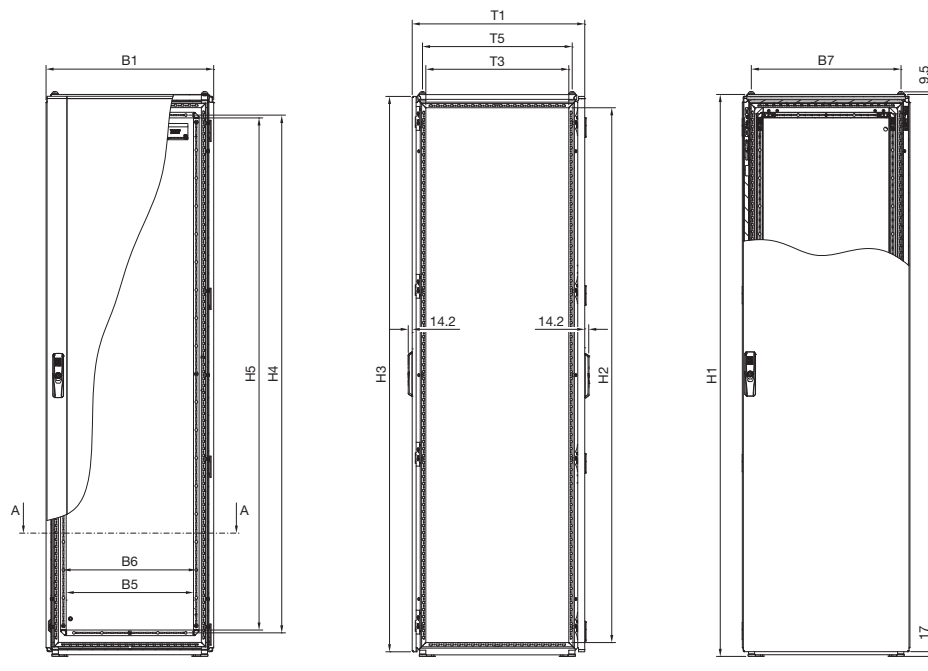

Section A – A

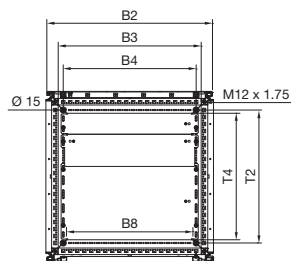

Enclosure

- B1 = Overall width
- B2 = Width of door
- B3 = Clearance of enclosure frame
- B4 = Hole distance, base/plinth attachment
- B5 = Clearance of tubular door frame rear door
- B6 = Distance between axes of the tubular door frame rows of holes rear door
- B7 = Roof attachment spacing
- B8 = Clearance opening, base
- H1 = Overall height
- H2 = Clearance of enclosure frame
- H3 = Height of door
- H4 = Distance between axes of the tubular door frame rows of holes rear door
- H5 = Clearance of tubular door frame rear door
- T1 = Overall depth
- T2 = Hole distance, base/plinth attachment
- T3 = Clearance of enclosure frame
- T4 = Clearance opening, base
- T5 = Roof attachment spacing

Note:

- With fitted side panels, the overall width (B1) is increased by 9 + 4 mm
- Between bayed enclosures, allow 1 mm for the seal

Model No.	Width dimensions mm								Height dimensions mm					Depth dimensions mm				
	B1	B2	B3	B4	B5	B6	B7	B8	H1	H2	H3	H4	H5	T1	T2	T3	T4	T5
8840.100	799	797	711	675	655	675	735	652	2008	1911	1984.5	1850	1830	816,5	675	711	652	735
8840.110	799	792	711	675	655	675	735	652	2008	1911	1984.5	1850	1830	816,5	675	711	652	735
8840.120	599	592	511	475	455	475	535	452	2008	1911	1984.5	1850	1830	616,5	475	511	452	535
8840.130	599	592	511	475	455	475	535	452	2008	1911	1984.5	1850	1830	616,5	475	511	452	535

Electronic enclosure

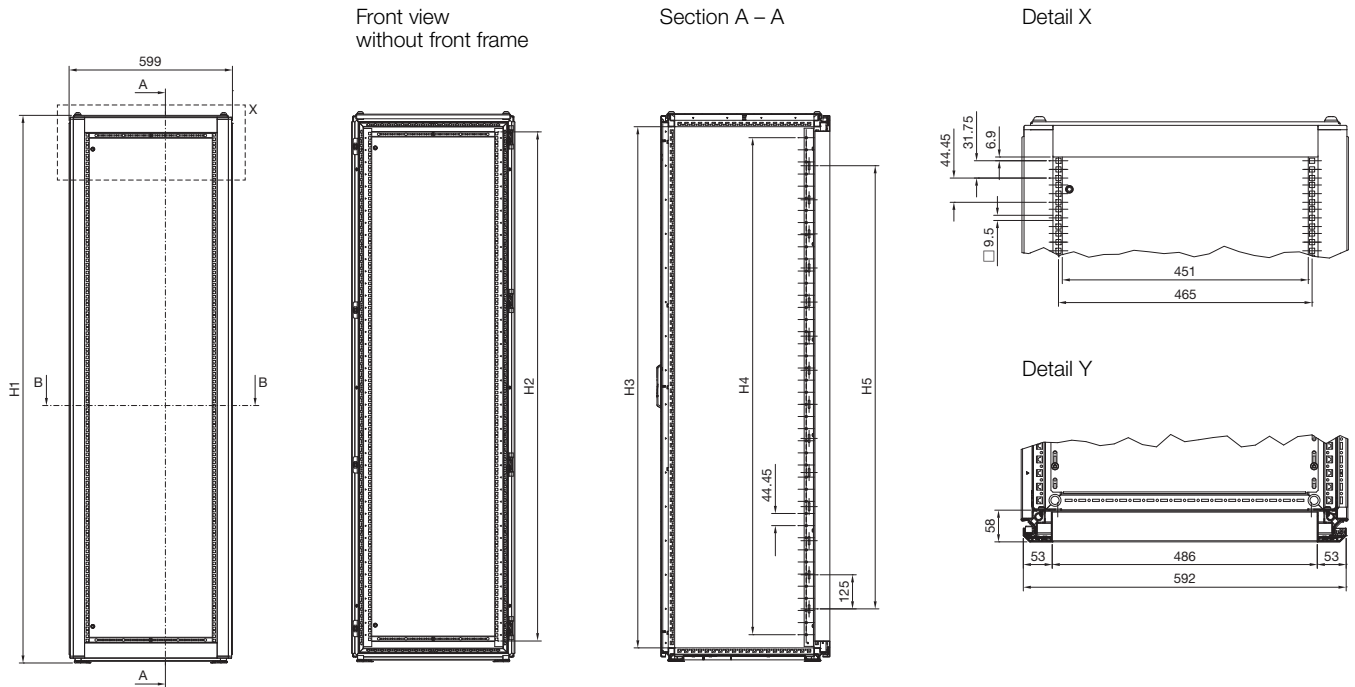

Section B – B

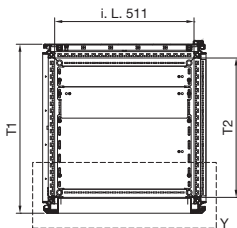

Model No.	Height dimensions						Depth dimensions		
	H1 mm	H2		H3 mm	H4		H5 mm	T1 mm	T2 mm
		mm	HE		mm	HE			
8410.000	1608	1466.6	33	c.w. 1511	1422.4	32	1375	619.5	c.w. 511
8418.000	1608	1466.6	33	c.w. 1511	1422.4	32	1375	619.5	c.w. 511
8430.000	2008	1866.9	42	c.w. 1911	1822.45	41	1625	819.5	c.w. 711
8438.000	2008	1866.9	42	c.w. 1911	1822.45	41	1625	819.5	c.w. 711

Baying enclosure system VX25

Technical details

IP66/NEMA 4, IP66/NEMA 4X

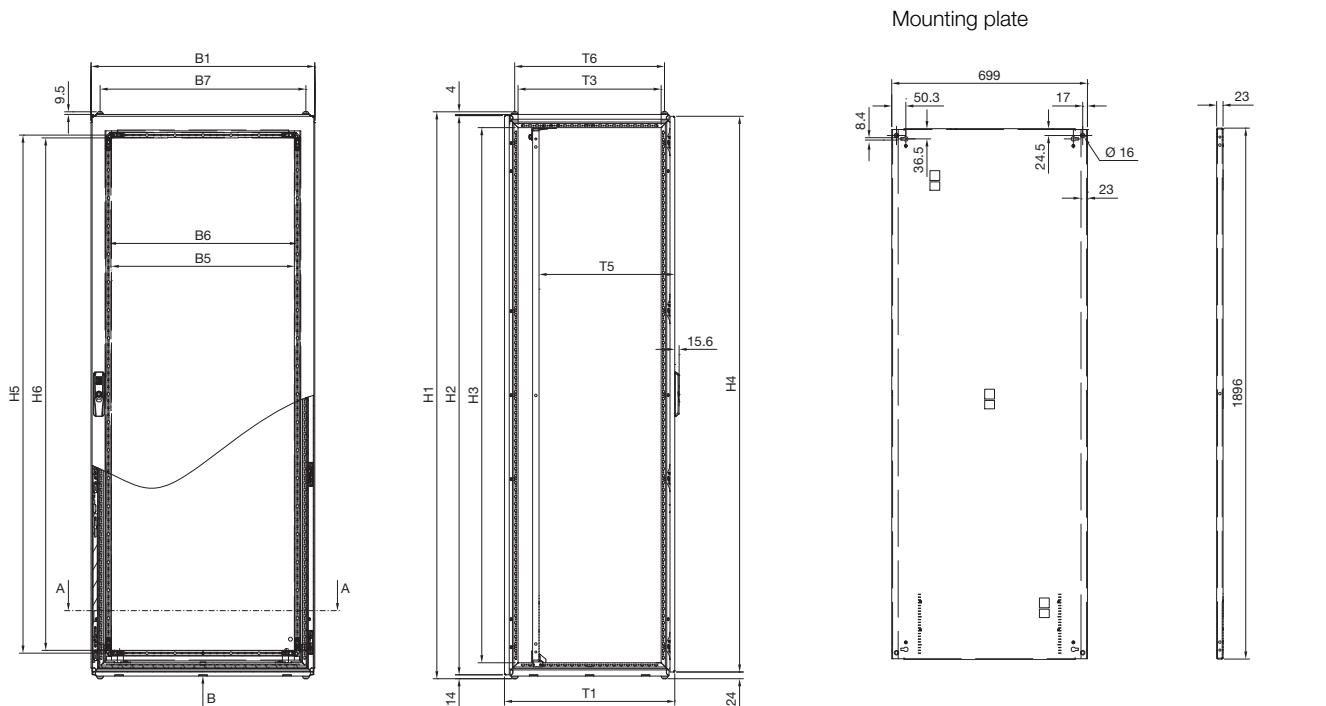

Section A – A

View B

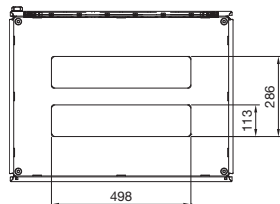
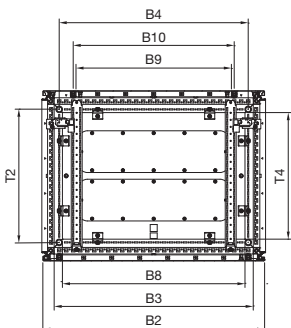

Mounting plate

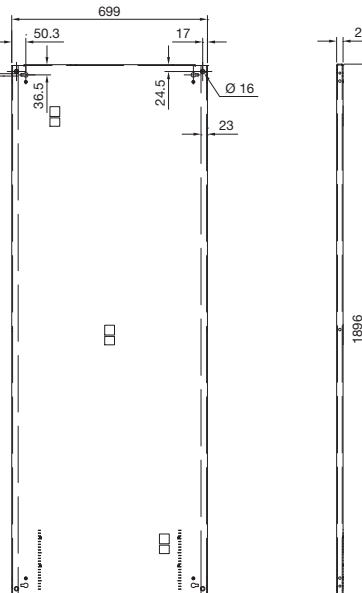

Enclosure

- B1 = Overall width
- B2 = Width of door
- B3 = Clearance of enclosure frame
- B4 = Hole distance, base/plinth attachment
- B5 = Clearance of tubular door frame
- B6 = Distance between axes of the tubular door frame rows of holes
- B7 = Roof attachment spacing
- B8 = Clearance opening, base
- B9 = Clearance of enclosure frame rear panel
- B10 = Distance between axes of the frame rows of holes on the rear panel
- H1 = Overall height
- H2 = Height of rear panel
- H3 = Clearance of enclosure frame
- H4 = Height of door
- H5 = Distance between axes of the tubular door frame rows of holes
- H6 = Clearance of tubular door frame
- T1 = Overall depth
- T2 = Hole distance, base/plinth attachment
- T3 = Clearance of enclosure frame
- T4 = Clearance opening, base
- T5 = Possible mounting depth (mounting plate assembly), depth-adjustable on a 25 mm pattern
- T6 = Roof attachment spacing

Note:

- With fitted side panels, the overall width (B1) is increased by 9 + 4 mm
- Between bayed enclosures, allow 1 mm for the seal

Model No.	Width dimensions mm										Height dimensions mm						Depth dimensions mm					
	B1	B2	B3	B4	B5	B6	B7	B8	B9	B10	H1	H2	H3	H4	H5	H6	T1	T2	T3	T4	T5	T6
8458.000	799	792	711	735	655	675	735	652	555	575	2025	1997	1911	1985	1850	1830	608	475	511	452	132 – 477	535
8807.000	799	792	711	735	655	675	735	652	555	575	2025	1997	1911	1985	1850	1830	608	475	511	452	132 – 477	535

Distribution enclosure

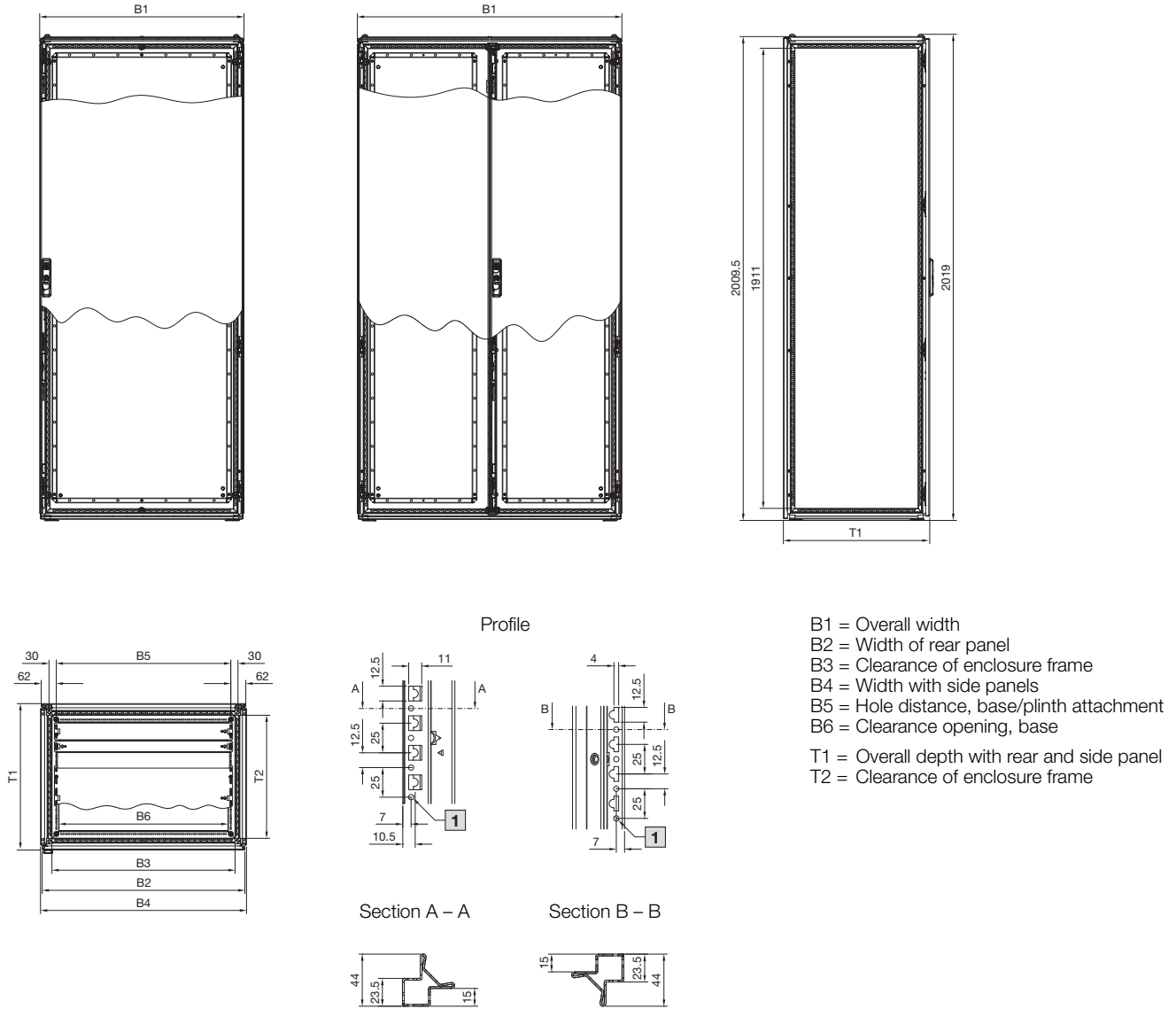

Model No.	Width dimensions mm						Depth dimensions mm	
	B1	B2	B3	B4	B5	B6	T1	T2
9666.916	849	842	761	856	725	702	608	511
9666.926	1099	1092	1011	1106	975	952	608	511
9666.956	849	842	761	856	725	702	408	311
9666.966	1099	1092	1011	1106	975	952	408	311

Baying enclosure system VX25

Technical details

Modular enclosure

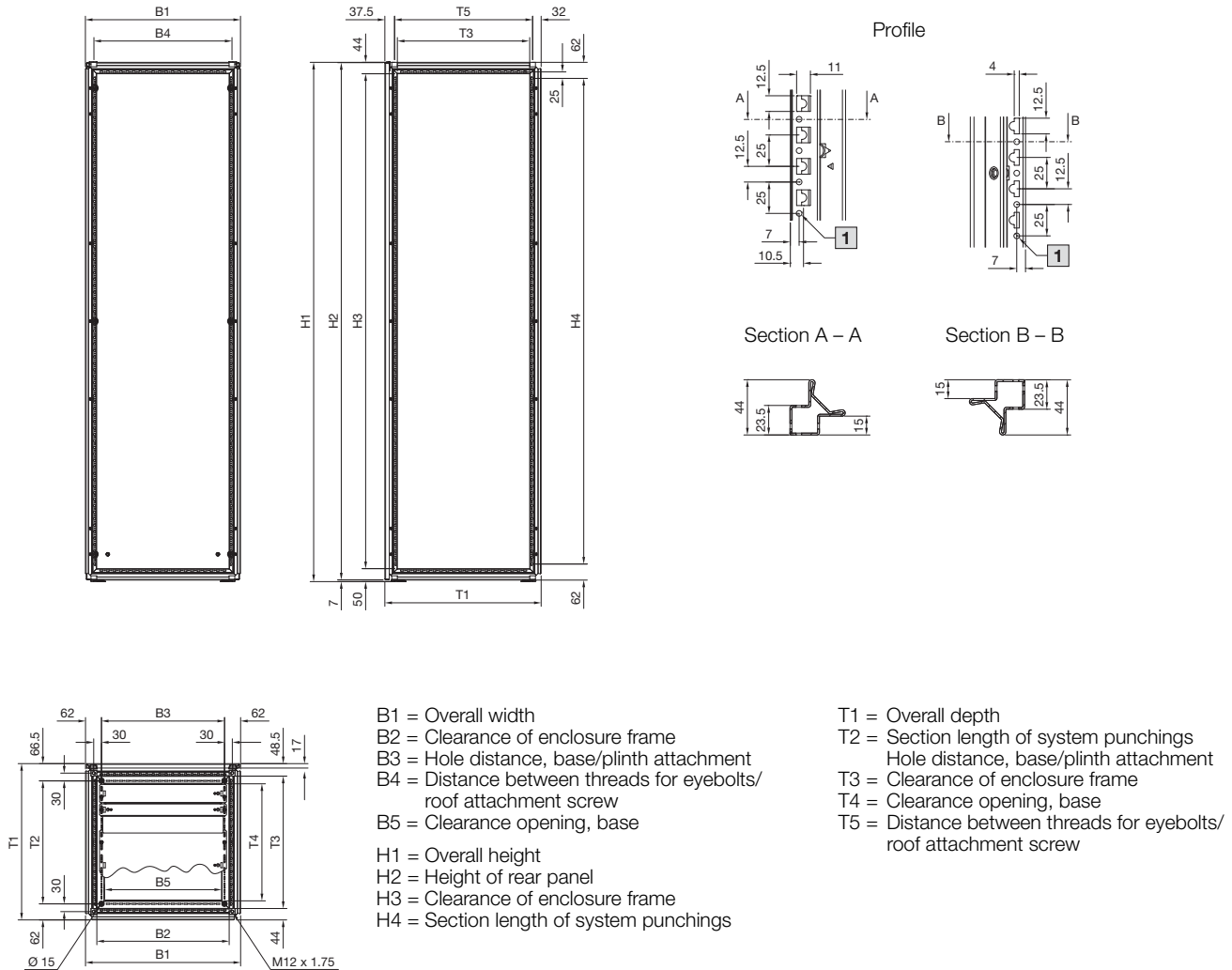

Model No.	Width dimensions mm					Height dimensions mm				Depth dimensions mm				
	B1	B2	B3	B4	B5	H1	H2	H3	H4	T1	T2	T3	T4	T5
9680.406	399	311	375	335	252	2005	1997	1911	1875	603.5	475	511	452	535
9680.408	399	311	375	335	252	2005	1997	1911	1875	803.5	675	711	652	735
9680.426	399	311	375	335	252	2205	2197	2111	2075	603.5	475	511	452	535
9680.428	399	311	375	335	252	2205	2197	2111	2075	803.5	675	711	652	735
9680.606	599	511	575	535	452	2005	1997	1911	1875	603.5	475	511	452	535
9680.608	599	511	575	535	452	2005	1997	1911	1875	803.5	675	711	652	735
9680.626	599	511	575	535	452	2205	2197	2111	2075	603.5	475	511	452	535
9680.628	599	511	575	535	452	2205	2197	2111	2075	803.5	675	711	652	735
9680.806	799	711	775	735	652	2005	1997	1911	1875	603.5	475	511	452	535
9680.808	799	711	775	735	652	2005	1997	1911	1875	803.5	675	711	652	735
9680.826	799	711	775	735	652	2205	2197	2111	2075	603.5	475	511	452	535
9680.828	799	711	775	735	652	2205	2197	2111	2075	803.5	675	711	652	735

Fuse-switch disconnecter enclosure

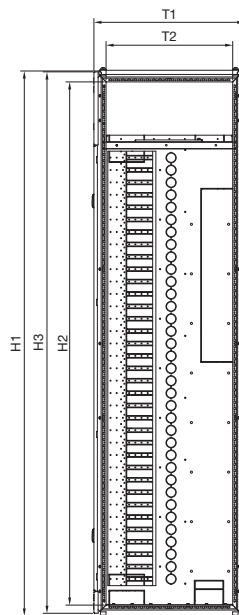
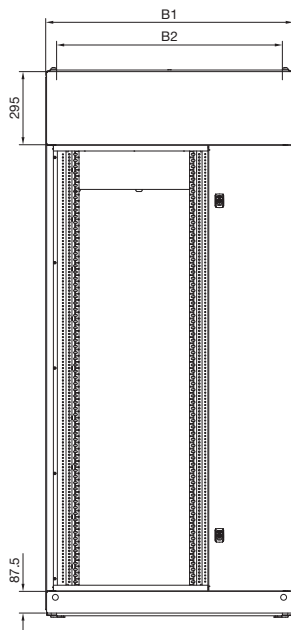

Profile

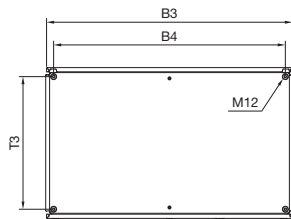
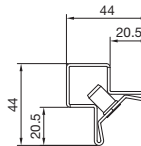
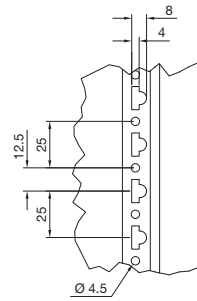

- B1 = Overall width
- B2 = Clearance of enclosure frame
- B3 = Width of rear panel
- B4 = Spacing between eyebolts
- H1 = Overall height
- H2 = Clearance of enclosure frame
- H3 = Height of rear panel
- T1 = Overall depth
- T2 = Clearance of enclosure frame
- T3 = Spacing between eyebolts

Model No. SV	Width dimensions mm				Height dimensions mm			Depth dimensions mm		
	B1	B2	B3	B4	H1	H2	H3	T1	T2	T3
9680.005	999	911	992	935	1999	1911	1985	608	511	535
9680.025	999	911	992	935	2199	2111	2185	608	511	535
9680.207	1199	1111	1192	1135	1999	1911	1985	808	711	735
9680.227	1199	1111	1192	1135	2199	2111	2185	808	711	735

Baying enclosure system VX25

Technical details

EMC enclosure

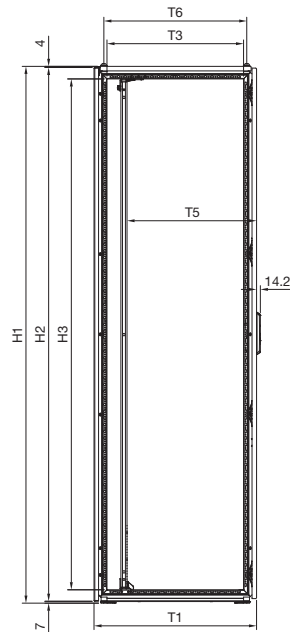
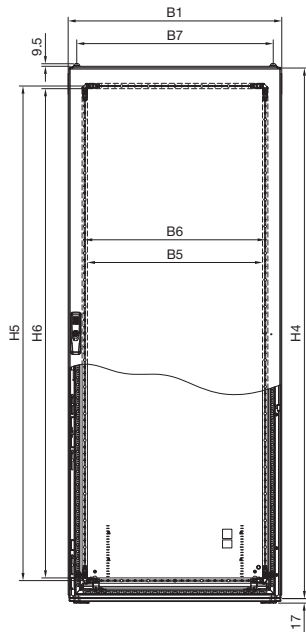

Mounting plate

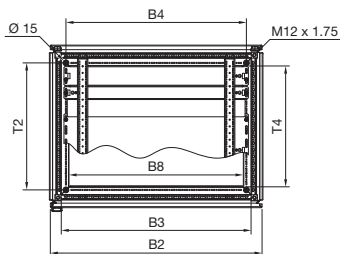
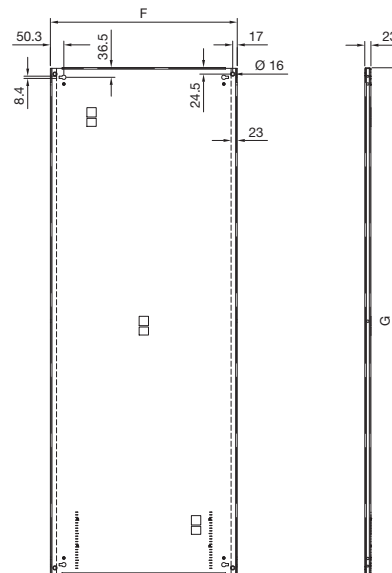

Enclosure

- B1 = Overall width
- B2 = Width of door
- B3 = Clearance of enclosure frame
- B4 = Hole distance, base/plinth attachment
- B5 = Clearance of tubular door frame
- B6 = Distance between axes of the tubular door frame rows of holes
- B7 = Roof attachment spacing
- B8 = Clearance opening, base
- H1 = Overall height
- H2 = Height of rear panel
- H3 = Clearance of enclosure frame
- H4 = Height of door
- H5 = Distance between axes of the tubular door frame rows of holes
- H6 = Clearance of tubular door frame
- T1 = Overall depth
- T2 = Hole distance, base/plinth attachment
- T3 = Clearance of enclosure frame
- T4 = Clearance opening, base
- T5 = Possible mounting depth (mounting plate assembly), depth-adjustable on a 25 mm pattern
- T6 = Roof attachment spacing

Mounting plate

- F = Overall width
- G = Overall height

Note:

- With fitted side panels, the overall width (B1) is increased by 9 + 4 mm
- Between bayed enclosures, allow 1 mm for the seal

Model No.	Width dimensions mm								Height dimensions mm						Depth dimensions mm					Mounting plate		
	B1	B2	B3	B4	B5	B6	B7	B8 ¹⁾	H1	H2	H3	H4	H5	H6	T1	T2	T3	T4 ¹⁾	T5	T6	F	G
8807.010	799	792	711	675	655	675	735	652	2008	1997	1911	1985	1850	1830	608	475	511	452	132 – 557	535	699	1896
8807.020	799	792	711	675	655	675	735	652	2008	1997	1911	1985	1850	1830	808	675	711	652	132 – 757	735	699	1896

¹⁾ The seal reduces the dimension by 16 mm in each case. The seal is not rigid but can be pressed in

Base/plinth system VX

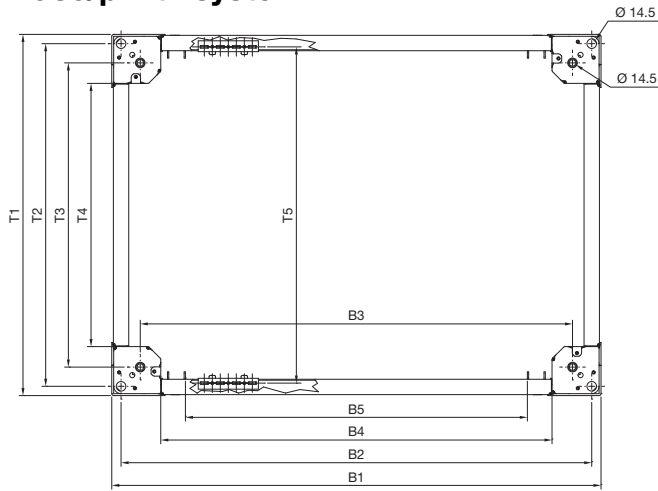

View A

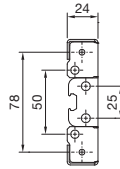

View B

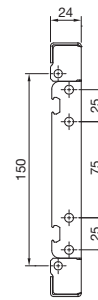

Baying

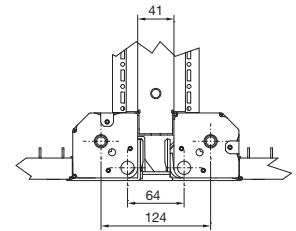

Base/plinth, 100 mm high

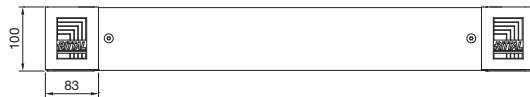

Base/plinth trim panels, solid, 100 mm high, front view

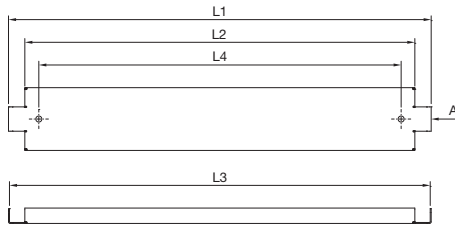

Rear view



Base/plinth trim panels with brush strip, 100 mm high, front view

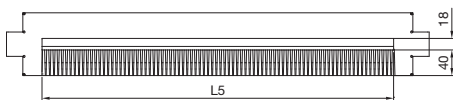

Base/plinth trim panels, vented, 100 mm high, front view



Base/plinth, 200 mm high

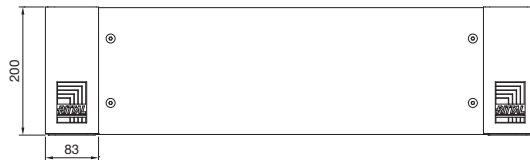

Base/plinth trim panels, solid, 200 mm high, front view

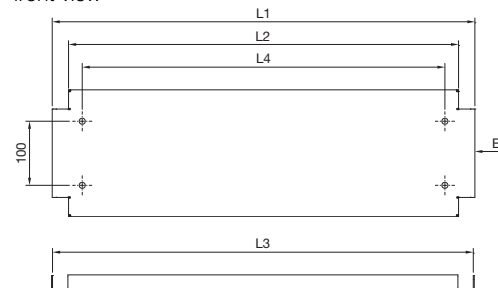

Rear view



For enclosure width or depth mm	Width dimensions mm					Length dimensions mm					Depth dimensions mm				
	B1	B2	B3	B4	B5	L1	L2	L3	L4	L5	T1	T2	T3	T4	T5 ¹⁾
300	264	235	175	111	34	160	109	157	66	-	264	235	175	111	225
400	364	335	275	211	134	260	209	257	166	-	364	335	275	211	325
500	464	435	375	311	234	360	309	357	266	-	464	435	375	311	425
600	564	535	475	411	334	460	409	457	366	330	564	535	475	411	525
800	764	735	675	611	534	660	609	657	566	530	764	735	675	611	725
850	814	785	725	661	585	710	659	707	616	-	-	-	-	-	775
1000	964	935	875	811	734	860	809	857	766	730	964	935	875	811	925
1100	1064	1035	975	911	834	960	909	957	866	-	-	-	-	-	1025
1200	1164	1135	1075	1011	934	1060	1009	1057	966	930	1164	1135	1075	1011	1125
1600	1564	1535	1475	1411	1334	1460	1409	1457	1366	-	-	-	-	-	1525
1800	1764	1735	1675	1611	1534	1660	1609	1657	1566	-	-	-	-	-	1725

¹⁾ T5 = Distance between system punchings including base/plinth installation bracket

Baying enclosure system VX25

Technical details

Swing frame, small

For 600 mm wide enclosures

For 800 mm wide enclosures optionally at the side or in the centre

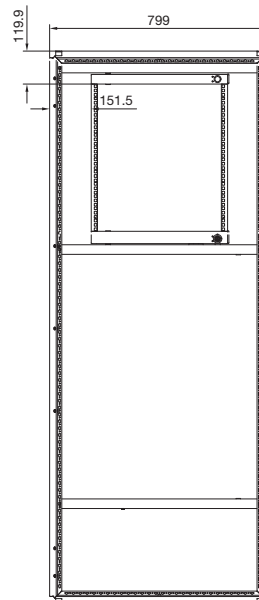
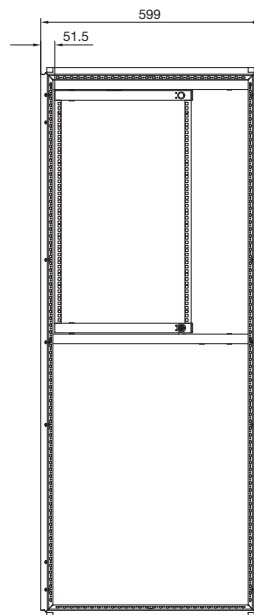
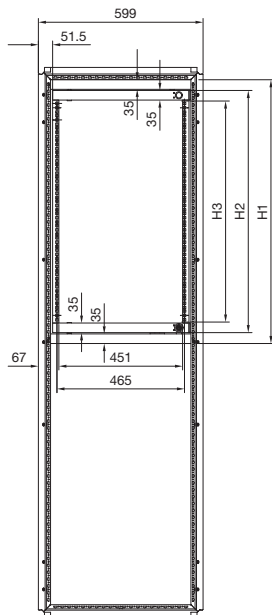

Height units	3 U	6 U	9 U	12 U	15 U	18 U
Model No.	8619.500	8619.510	8619.520	8619.530	8619.540	8619.550
H1 mm	285	435	560	685	835	960
H2 mm	206	356	481	606	756	881
H3 mm	136	286	411	536	686	811

Installation depth T max. = mm with dimension D¹⁾ of at least 45 mm

Enclosure width mm	600	800	800
Internal mounting	Centre	Side	Centre
Enclosure depth mm	1 T max. 400 185 500 185 ≥ 600 185	1 T max. 310 410 500	1 T max. 310 370 370

¹⁾ D = Distance from inner edge of door to front edge of swing frame, may be installed deeper on a 25 mm pitch pattern

Swing frame, small

VX25 installation examples

Partial installation

in 600 and 800 mm wide enclosures, each in the highest or lowest position.

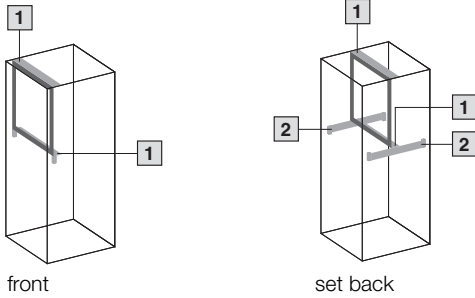

Partial installation, centre

in 600 and 800 mm wide enclosures.

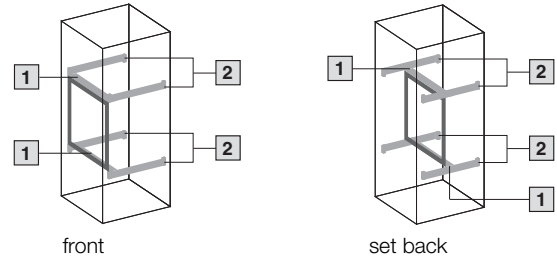

Side installation

With an enclosure depth of 600 or 800 mm, side installation of a partial mounting plate is exactly the same as installation parallel to the front.

For access to the swing frame, we recommend hinges for the side panel.

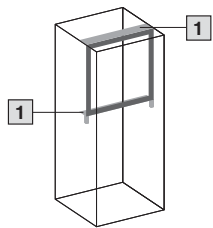

1 Installation kit for swing frame, small

2 Punched section with mounting flange, 23 x 64 mm

Baying enclosure system VX25

Technical details

Swing frame, large Without trim panel

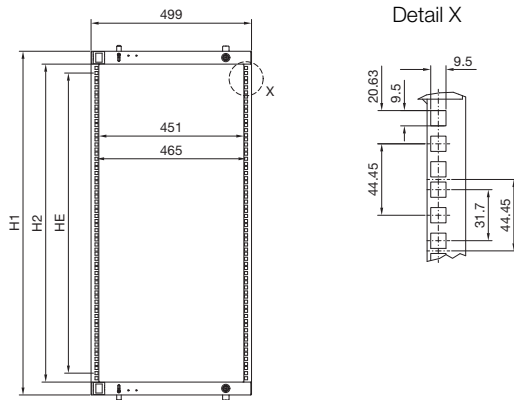

Height units	22 U	31 U	35 U	40 U	44 U
Model No.	8619.010	8619.011	8619.012	8619.013	8619.014
For enclosure height mm (or higher)	1200	1600	1800	2000	2200
H1 mm	1068	1468	1668	1868	2068
H2 mm	988	1388	1588	1788	1988
Depth mm	80	80	80	80	80

Installation depth T max. = mm with dimension D¹⁾ of at least 48 mm

Enclosure width mm	600	1200	1200
Internal mounting	Centre	Left or right	Left and right
Enclosure depth mm	1 T max.	1 T max.	1 T max.
400	210	295	295
500	210	395	360
600	210	495	360
800	210	695	360

¹⁾D = Distance from inner edge of door to front edge of swing frame, may be installed deeper on a 25 mm pitch pattern

Swing frame, large

Without trim panel, VX25 installation examples

Full installation

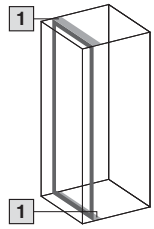

600 mm front

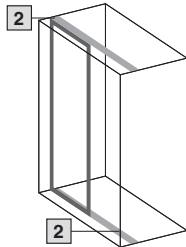

1200 mm front

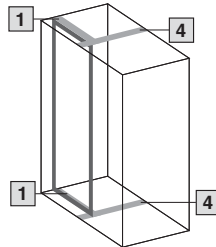

1200 mm front with system divider

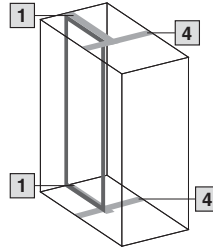

1200 mm set back with system divider

Side installation

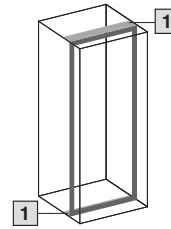

With an enclosure depth of 600 mm, side installation of a large swing frame is identical to installation parallel to the front. For access to the swing frame, we recommend hinges for the side panel.

Partial installation, top

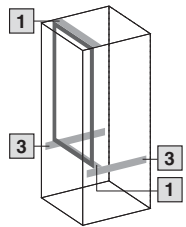

600 mm front

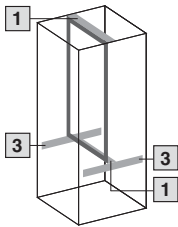

600 mm set back

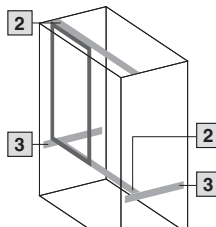

1200 mm front

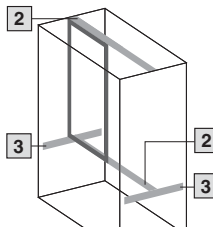

1200 mm set back

- 1** Installation kit for 600 mm wide enclosures
- 2** Installation kit for 1200 mm wide enclosures
- 3** Punched section with mounting flange, 23 x 64 mm
- 4** System divider

Partial installation, centre

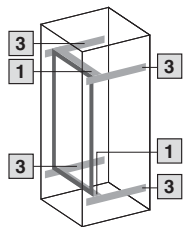

600 mm front

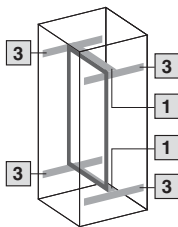

600 mm set back

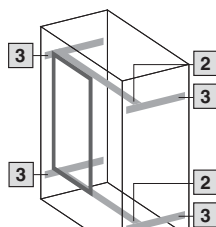

1200 mm front

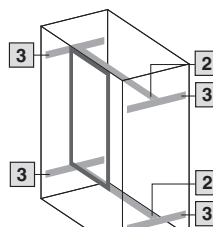

1200 mm set back

Baying enclosure system VX25

Technical details

Swing frame, large

With trim panel

Equipment at sides
(built in VX25)

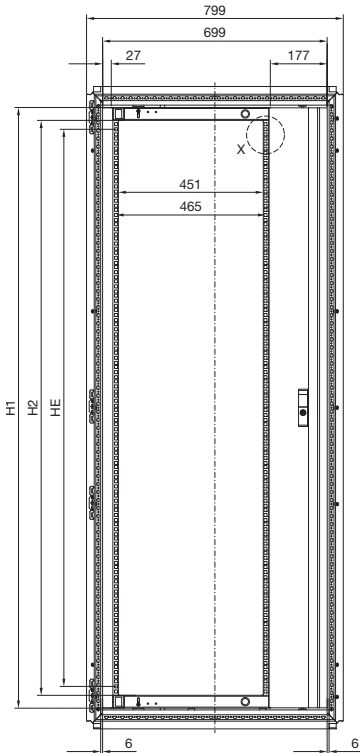

Equipment in centre
(built in VX25)

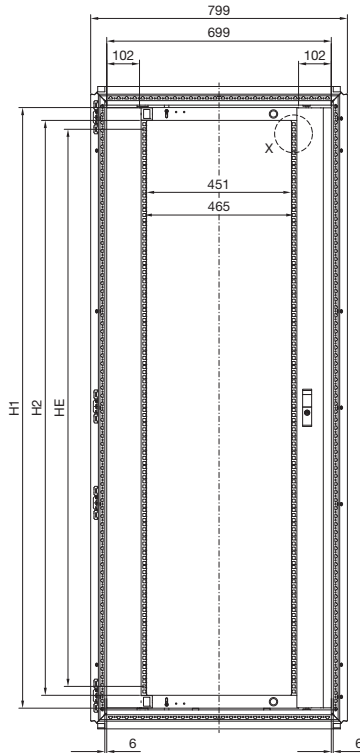

Detail X

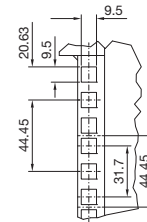

Height units	22 U		31 U		35 U		40 U		44 U		
	Side	Centre	Side	Centre	Side	Centre	Side	Centre	Side	Centre	
Trim panel											
Model No. SR	RAL 7035	8619.020	8619.030	8619.021	-	8619.022	8619.032	8619.023	8619.033	8619.024	8619.034
For enclosure height mm (or higher)		1200		1600		1800		2000		2200	
H1 mm		1068		1468		1668		1868		2068	
H2 mm		988		1388		1588		1788		1988	
Depth mm		80		80		80		80		80	

Installation depth T max. = mm with dimension D¹⁾ of at least 48 mm

Enclosure width mm	800			
Internal mounting	Side		Centre	
Hinge	130°	180°	130°	180°
Enclosure depth mm	1 T max.	1 T max.	1 T max.	1 T max.
400	295	260	265	150
500	395	360	370	250
600	470	440	370	330
800	470	440	370	330

¹⁾ D = Distance from inner edge of door to front edge of swing frame, may be installed deeper on a 25 mm pitch pattern

Swing frame, large

With trim panel, VX25 installation examples

Full installation

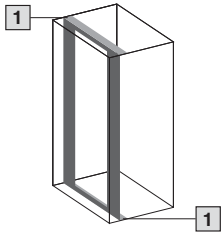

800 mm front

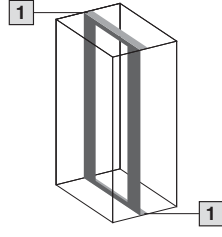

800 mm set back

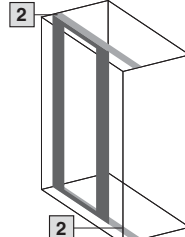

1200 mm front

Side installation

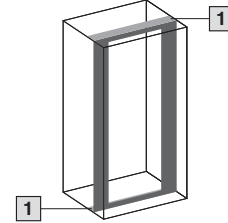

With an enclosure depth of 800 mm, side installation of a large swing frame is identical to installation parallel to the front. For access to the swing frame, we recommend hinges for the side panel.

Partial installation, top

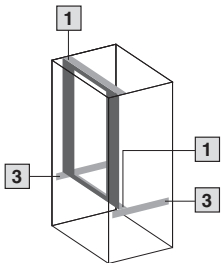

800 mm front

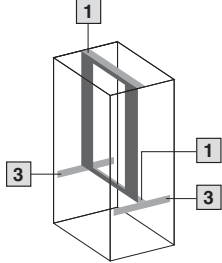

800 mm set back

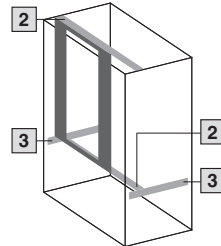

1200 mm front

- 1 Installation kit for 800 mm wide enclosures
- 2 Installation kit for 1200 mm wide enclosures
- 3 Punched section with mounting flange, 23 x 64 mm

Partial installation, centre

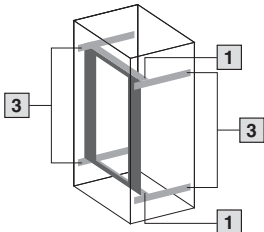

800 mm front

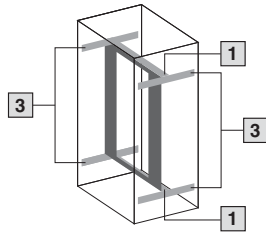

800 mm set back

Baying enclosure system VX25

Technical details

Partial mounting plate

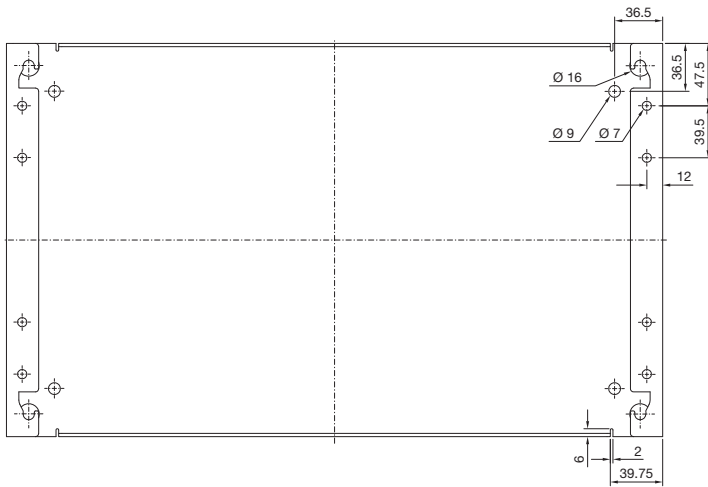
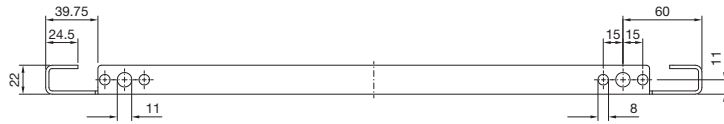
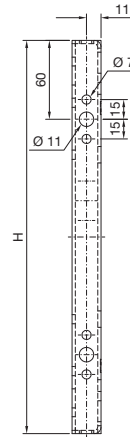
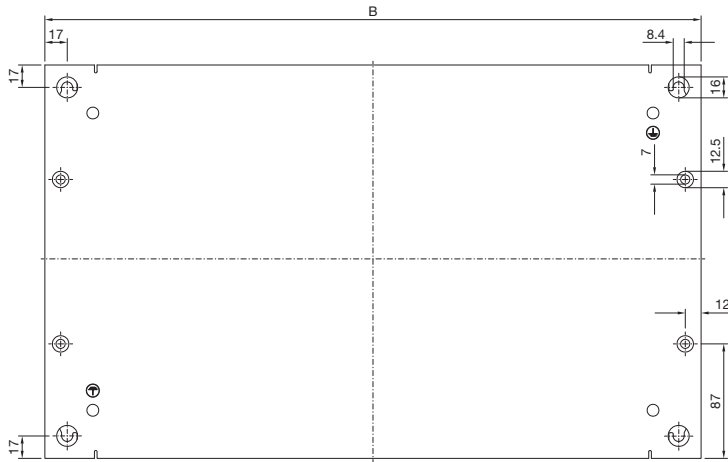

Model No.	W (B)	H
8617.510	499	299
8617.520	499	399
8617.530	499	499
8617.540	499	699
8617.550	499	774
8617.560	699	299
8617.570	699	399
8617.580	699	699
8617.590	899	299
8617.600	899	399
8617.610	899	499
8617.620	1099	299
8617.630	1099	399
8617.640	1099	499

List of model numbers

Model No.	Page	Model No.	Page	Model No.	Page	Model No.	Page
1962.200	210	2413.550	183	2545.000	130	2736.520	138
1963.200	210	2414.000	183	2546.000	130	2736.530	138
1980.200	210	2414.500	183	2547.000	130	2736.540	138
2090.000	212	2415.000	183	2548.000	130	2793.560	139
2308.000	130	2415.100	137	2549.000	130	2817.000	92
2309.000	168	2415.500	158	2549.500	130	2843.160	183
2311.225	134	2416.000	130	2559.000	186	2843.200	183
2311.250	134	2418.000	130	2564.000	186	2843.250	183
2313.150	168	2419.000	130	2565.000	186	2843.320	183
2313.750	168	2422.000	145	2565.120	186	2843.400	183
2335.000	187	2423.000	145	2566.000	186	2843.500	183
2350.000	204	2424.100	144	2567.000	186	2843.630	183
2351.000	204	2425.100	144	2568.000	186	2859.000	96
2352.000	204	2426.100	144	2569.000	186	2899.200	202
2353.000	204	2427.100	144	2580.000	201	2899.250	202
2354.000	204	2435.100	131	2580.003	201	2899.320	202
2355.000	204	2435.400	131	2580.004	201	2899.400	202
2356.000	204	2440.905	95	2580.005	201	3110.000	180
2357.000	204	2446.000	135	2580.006	201	3118.000	180
2358.000	204	2467.000	129	2580.007	201	3201.800	121
2359.000	204	2468.000	129	2580.008	201	3201.810	121
2360.000	204	2469.000	129	2580.009	201	3201.820	121
2364.000	186	2477.000	107	2580.010	201	3201.830	121
2365.000	171	2478.000	107	2580.011	201	3201.840	121
2366.000	171	2479.000	107	2580.012	201	3201.850	121
2367.040	183	2480.000	107	2580.013	201	3307.700	120
2367.060	183	2481.000	107	2580.014	201	3307.740	120
2367.080	183	2486.400	172	2580.100	201	3310.700	120
2367.120	183	2486.600	172	2580.115	201	3310.740	120
2367.160	183	2487.000	172	2580.116	201	4114.000	135
2367.200	183	2493.500	130	2580.117	201	4115.000	135
2379.600	140	2500.200	177	2580.118	201	4115.500	135
2379.800	140	2500.210	177	2580.119	201	4116.000	135
2379.900	140	2500.220	177	2580.120	201	4116.500	135
2388.050	182	2500.300	177	2580.121	201	4118.000	135
2388.100	182	2500.310	177	2580.122	201	4118.500	135
2388.125	182	2500.400	178	2580.123	201	4120.000	135
2388.150	182	2500.410	178	2580.124	201	4123.000	135
2388.200	182	2500.420	178	2580.125	201	4124.000	135
2388.280	182	2500.430	178	2582.100	201	4133.000	170
2388.650	182	2500.435	178	2582.200	201	4134.000	170
2388.850	182	2500.440	178	2582.400	201	4162.000	171
2400.000	107	2500.450	178	2582.600	201	4163.000	171
2401.000	107	2500.460	178	2583.080	201	4164.500	171
2402.000	107	2500.470	178	2583.100	201	4165.500	171
2411.601	200	2500.490	179	2589.000	205	4199.000	170
2411.611	200	2500.500	178	2590.000	205	4311.000	198
2411.621	200	2500.530	178	2591.000	205	4316.000	198
2411.631	200	2500.680	178	2592.000	205	4317.000	198
2411.641	200	2500.710	179	2593.000	205	4318.000	198
2411.651	200	2500.711	179	2594.000	205	4333.120	154
2411.661	200	2500.712	179	2595.000	205	4333.160	154
2411.671	200	2500.713	179	2596.000	205	4333.180	154
2411.801	200	2500.714	179	2597.000	205	4348.500	181
2411.811	200	2500.715	179	2735.250	138	4394.000	167
2411.821	200	2504.000	172	2735.500	138	4395.000	167
2411.831	200	2504.500	172	2735.510	138	4396.000	167
2411.841	200	2504.800	172	2735.520	138	4396.500	167
2411.851	200	2510.000	136	2735.530	138	4398.000	167
2411.861	200	2512.000	136	2735.540	138	4398.500	167
2411.871	200	2513.000	135	2735.560	138	4531.001	212
2412.216	186	2514.000	135	2735.570	138	4532.000	169
2412.225	186	2515.000	135	2735.580	138	4540.000	114
2412.316	186	2521.000	130	2735.590	138	4540.500	114
2412.325	186	2531.000	130	2736.500	138	4568.000	145
2413.375	183	2532.000	130	2736.510	138	4568.500	145

List of model numbers

Model No.	Page	Model No.	Page	Model No.	Page	Model No.	Page
4590.700	151	8001.213	98	8406.000	63	8617.030	164
4591.700	151	8001.214	98	8410.000	68, 219	8617.040	164
4592.700	151	8001.215	98	8418.000	68, 219	8617.050	164
4595.000	145	8001.216	98	8430.000	68, 219	8617.060	164
4597.000	169	8001.217	98	8438.000	68, 219	8617.100	164
4612.000	96	8001.218	98	8450.000	78	8617.110	164
4638.600	134	8001.219	98	8451.000	78	8617.120	164
4638.800	134	8001.220	98	8452.000	78	8617.130	164
4694.000	166	8001.221	98	8453.000	77	8617.140	164
4695.000	166	8001.222	98	8454.000	76	8617.150	164
4696.000	166	8001.223	98	8455.000	77	8617.160	164
4697.000	166	8001.224	98	8456.000	76	8617.170	164
4911.000	109	8001.225	98	8457.000	77	8617.180	164
4911.100	109	8001.239	98	8458.000	79	8617.190	164
4912.000	109	8001.241	98	8485.000	59	8617.200	164
4916.000	109	8001.242	98	8486.000	60	8617.210	164
4918.000	109	8001.243	98	8600.255	95	8617.351	152
4920.000	109	8004.000	61	8600.265	95	8617.352	153
4933.000	168	8005.000	62	8600.455	95	8617.353	151
4934.000	168	8006.000	63	8600.465	95	8617.360	153
4935.000	168	8080.000	58	8600.510	95	8617.370	154
4937.000	168	8084.000	58	8600.520	95	8617.400	154
4943.000	167	8100.700	92	8600.655	95	8617.401	154
4944.000	167	8100.710	93	8600.665	95	8617.402	154
4945.000	167	8100.711	93	8600.855	95	8617.403	154
4946.000	167	8100.730	165	8600.865	95	8617.500	112
4947.000	167	8100.731	165	8601.450	94	8617.501	112
5001.080	204	8100.732	165	8601.680	94	8617.502	112
5001.081	204	8100.733	165	8601.860	185	8617.503	112
5001.082	204	8100.740	165	8604.000	61	8617.505	114
5001.083	204	8100.741	165	8605.000	62	8617.506	113
6148.000	96	8100.742	165	8606.000	63	8617.507	113
7077.000	205	8100.743	165	8608.000	64	8617.508	113
7078.000	205	8100.745	165	8609.140	106	8617.510	155, 232
7094.130	212	8100.770	97	8609.150	106	8617.520	155, 232
7097.000	205	8100.771	97	8609.160	106	8617.530	155, 232
7097.220	205	8100.780	96	8609.170	106	8617.540	155, 232
7097.260	205	8104.245	102	8609.200	104	8617.550	155, 232
7097.300	205	8105.245	102	8609.201	104	8617.560	155, 232
7097.340	205	8106.245	102	8609.202	104	8617.570	155, 232
7098.000	205	8106.260	103	8609.203	104	8617.580	155, 232
7098.100	205	8106.760	181	8609.204	104	8617.590	155, 232
7099.000	205	8108.245	102	8609.205	104	8617.600	155, 232
7164.035	176	8108.760	181	8609.206	104	8617.610	155, 232
7165.035	176	8115.245	102	8609.207	104	8617.620	155, 232
7166.035	176	8126.245	102	8609.210	105	8617.630	155, 232
7166.735	176	8128.245	102	8609.211	105	8617.640	155, 232
7184.035	176	8145.245	102	8609.212	105	8617.650	157
7185.035	176	8165.245	102	8609.213	105	8617.655	158
7186.035	176	8166.245	102	8609.220	107	8617.660	160
7186.735	176	8168.245	102	8609.230	107	8617.661	160
7464.035	176	8184.245	102	8609.390	106	8617.662	160
7465.035	176	8185.245	102	8611.180	129	8617.663	160
7466.035	176	8186.245	102	8611.190	129	8617.664	160
7466.735	176	8204.000	61	8611.200	129	8617.665	160
7484.035	176	8205.000	62	8612.400	168	8617.700	166
7485.035	176	8206.000	63	8612.410	169	8617.710	166
7486.035	176	8208.000	64	8612.960	168	8617.720	166
7486.735	176	8215.000	55	8612.980	168	8617.730	166
7495.000	96	8226.000	65	8613.151	212	8617.800	167
7526.964	169	8245.000	56	8613.161	212	8617.810	167
7829.200	187	8265.000	57	8613.181	212	8617.820	167
7967.000	145	8284.000	58	8615.000	55	8617.830	167
8001.210	98	8285.000	59	8617.000	164	8618.000	118
8001.211	98	8286.000	60	8617.010	164	8618.010	118
8001.212	98	8405.000	62	8617.020	164	8618.020	118

List of model numbers

Model No.	Page	Model No.	Page	Model No.	Page	Model No.	Page
8618.030	118	8619.051	210	8640.004	89	8840.120	67
8618.040	118	8619.270	210	8640.005	89	8840.130	67
8618.050	118	8619.300	211	8640.006	89	8845.000	56
8618.110	118	8619.310	211	8640.007	89	8865.000	57
8618.120	118	8619.320	211	8640.008	89	8880.000	59
8618.200	128	8619.330	211	8640.009	89	8881.000	60
8618.220	128	8619.400	204	8640.020	89	8884.000	58
8618.230	128	8619.410	204	8640.021	89	8885.000	59
8618.240	128	8619.420	204	8640.022	89	8886.000	60
8618.250	128	8619.430	204	8640.023	89	8951.000	108
8618.270	128	8619.440	204	8640.024	89	8951.010	108
8618.280	128	8619.450	204	8640.025	89	8951.020	108
8618.300	129	8619.460	204	8640.026	89	8951.030	108
8618.301	129	8619.500	208, 226	8640.027	89	8952.010	108
8618.302	129	8619.510	208, 226	8640.030	90	8952.020	108
8618.303	129	8619.520	208, 226	8640.031	90	8952.030	108
8618.304	129	8619.530	208, 226	8640.032	90	9665.750	147
8618.305	129	8619.540	208, 226	8640.033	90	9665.760	147
8618.306	129	8619.550	208, 226	8640.034	90	9665.770	147
8618.307	129	8619.600	208	8640.035	90	9665.780	147
8618.308	129	8619.610	208	8640.036	90	9665.785	147
8618.330	119	8619.700	134	8640.040	90	9666.000	189
8618.335	119	8619.710	134	8640.041	90	9666.010	189
8618.340	119	8619.720	134	8640.042	90	9666.020	189
8618.410	137	8619.730	134	8640.043	90	9666.030	189
8618.420	136	8619.740	134	8640.044	90	9666.040	189
8618.425	136	8619.750	134	8640.045	90	9666.050	189
8618.430	136	8619.800	198	8640.046	90	9666.053	189
8618.450	139	8619.801	198	8645.000	56	9666.060	189
8618.451	139	8619.802	198	8665.000	57	9666.063	189
8618.460	128	8619.803	198	8684.000	58	9666.070	189
8618.501	144	8620.010	94	8685.000	59	9666.073	189
8618.511	144	8620.011	94	8686.000	60	9666.080	189
8618.521	144	8620.050	91	8700.030	102	9666.090	189
8618.531	144	8620.051	91	8700.040	102	9666.100	189
8618.541	145	8620.052	91	8700.050	102	9666.110	189
8618.600	185	8620.053	91	8700.140	114	9666.120	189
8618.800	199	8620.060	91	8700.150	114	9666.130	189
8618.801	199	8620.061	91	8700.160	114	9666.133	189
8618.802	199	8620.062	91	8800.695	181	9666.140	189
8618.803	199	8620.063	91	8800.750	203	9666.143	189
8618.810	199	8620.070	92	8800.751	203	9666.150	189
8618.811	199	8620.071	92	8800.752	203	9666.160	189
8618.812	199	8620.072	92	8800.753	203	9666.170	189
8618.813	199	8620.080	92	8800.754	203	9666.180	189
8618.820	182	8620.081	92	8800.755	203	9666.190	189
8618.821	182	8620.082	92	8800.770	203	9666.200	189
8618.822	182	8620.090	91	8800.845	114	9666.210	189
8618.823	182	8620.091	91	8800.855	114	9666.213	189
8619.010	209, 228	8620.092	90	8800.865	114	9666.220	189
8619.011	209, 228	8620.093	90	8800.875	114	9666.223	189
8619.012	209, 228	8620.094	90	8800.885	114	9666.230	189
8619.013	209, 228	8620.095	90	8801.000	119	9666.240	189
8619.014	209, 228	8620.100	94	8801.010	119	9666.250	189
8619.020	209, 230	8620.400	93	8801.260	125	9666.260	189
8619.021	209, 230	8620.500	125	8804.000	61	9666.270	189
8619.022	209, 230	8620.501	125	8805.000	62	9666.280	189
8619.023	209, 230	8620.502	125	8806.000	63	9666.290	189
8619.024	209, 230	8620.520	125	8807.000	69	9666.293	189
8619.030	209, 230	8620.521	125	8807.010	74	9666.300	189
8619.032	209, 230	8620.901	97	8807.020	74	9666.303	189
8619.033	209, 230	8626.000	65	8808.000	64	9666.310	190
8619.034	209, 230	8640.000	89	8815.000	55	9666.340	190
8619.040	210	8640.001	89	8826.000	65	9666.350	190
8619.041	210	8640.002	89	8840.100	67	9666.380	190
8619.042	210	8640.003	89	8840.110	67	9666.390	190

List of model numbers

Model No.	Page	Model No.	Page	Model No.	Page
9666.400	190	9681.548	146	9682.188	123
9666.410	190	9681.564	146	9682.190	123
9666.420	190	9681.566	146	9682.192	123
9666.430	191	9681.568	146	9682.194	123
9666.440	191	9681.586	146	9682.196	123
9666.520	193	9681.588	146	9682.198	123
9666.530	193	9681.594	146	9682.314	124
9666.533	193	9681.596	146	9682.316	124
9666.550	191	9681.646	146	9682.318	124
9666.560	191	9681.648	146	9682.320	124
9666.570	191	9681.660	146	9682.322	124
9666.580	191	9681.662	146	9682.324	124
9666.583	191	9681.666	146	9682.326	124
9666.590	192	9681.668	146	9682.328	124
9666.600	192	9681.680	146	9682.330	124
9666.603	192	9681.682	146	9682.332	124
9666.640	192	9681.686	146	9682.334	124
9666.650	194	9681.688	146	9682.336	124
9666.660	194	9681.806	146	9682.338	124
9666.665	194	9681.808	146	9682.340	124
9666.670	194	9681.826	146	9682.342	124
9666.680	194	9681.828	146	9682.344	124
9666.702	195	9681.846	146	9682.346	124
9666.703	195	9681.848	146	9682.348	124
9666.704	195	9681.866	146	9682.350	124
9666.705	195	9681.868	146	9682.352	124
9666.706	195	9681.886	146	9682.354	124
9666.707	195	9681.888	146	9682.356	124
9666.711	195	9682.104	123	9682.358	124
9666.712	195	9682.106	123	9785.040	129
9666.722	195	9682.108	123	9785.042	129
9666.723	195	9682.124	123		
9666.724	195	9682.126	123		
9666.732	195	9682.128	123		
9666.740	195	9682.140	123		
9666.902	188	9682.142	123		
9666.912	188	9682.143	123		
9666.916	70, 221	9682.144	123		
9666.922	188	9682.146	123		
9666.926	70, 221	9682.148	123		
9666.932	188	9682.150	123		
9666.956	70, 221	9682.152	123		
9666.966	70, 221	9682.154	123		
9674.790	147	9682.156	123		
9680.005	73, 223	9682.158	123		
9680.025	73, 223	9682.160	123		
9680.207	73, 223	9682.161	123		
9680.227	73, 223	9682.162	123		
9680.406	71, 222	9682.163	123		
9680.408	71, 222	9682.164	123		
9680.426	72, 222	9682.166	123		
9680.428	72, 222	9682.167	123		
9680.606	71, 222	9682.168	123		
9680.608	71, 222	9682.169	123		
9680.626	72, 222	9682.170	123		
9680.628	72, 222	9682.172	123		
9680.806	71, 222	9682.174	123		
9680.808	71, 222	9682.176	123		
9680.826	72, 222	9682.178	123		
9680.828	72, 222	9682.180	123		
9681.204	124	9682.181	123		
9681.206	124	9682.182	123		
9681.208	124	9682.183	123		
9681.514	146	9682.184	123		
9681.516	146	9682.186	123		
9681.546	146	9682.187	123		

Numerics

482.6 mm (19") fastener, 1 U 212

A

Accessories 194
 – Distribution enclosures
 Adaptor
 – for connector cut-outs 107
 – for twin castors and levelling feet 97
 Adaptor piece, 482.6 mm (19") 211
 Adaptor section, 482.6 mm (19") 211
 Angle piece 170
 Angular baying bracket 113
 Assembly components 170, 172
 Assembly parts 186
 – for earth straps

B

Base mounting plate
 – for base/plinth VX 92
 Base/plinth
 – for areas at risk from earthquakes 185
 Base/plinth adaptor
 – for twin castors and levelling feet 97
 Base/plinth corner pieces with base/plinth trim panels, front and rear
 – Sheet steel 89
 – Stainless steel 91
 Base/plinth installation bracket 93
 Base/plinth trim panel, sides 90
 Base/plinth trim panels
 – Sides, stainless steel 92
 – Vented 91
 – with brush strip 90
 Basic enclosure with glazed door VX25 66
 Baying block, internal 112
 Baying bracket, internal 112
 Baying connector, external 112
 Baying cover
 – for base/plinth VX 94
 Baying enclosure system VX25
 – Basic enclosure with glazed door 66
 – Distribution enclosure 70
 – Electronic enclosure 68
 – EMC enclosure 74
 – Fuse-switch-disconnector enclosure 73
 – IP66/NEMA 4 69
 – IP66/NEMA 4X 79
 – Modular enclosure 71, 72
 – Sheet steel 54
 – Stainless steel 75
 Baying kit, VX25 to TS 8 114
 Baying seal 113
 Blanking cover
 – ISV 194
 Bracket
 – Wall bracket 145
 Bracket/spacer 170
 Busbar modules ISV 193
 – N/PE 192
 BVX25 baying enclosure system VX25
 – Distribution enclosure 70

C

C rail
 – 30/15 167
 Cable chamber 95
 Cable clamp
 – for C rail 205
 – for cable clamp rails 204
 Cable clamp rail
 – C rail 204
 – Right angle section 204
 Cable conduit/cable conduit holder 205
 Cable duct 203
 Cable entry gland 147
 Cable entry grommet 198
 Cable entry plate 198
 Cable gland
 – Brass 200
 – Polyamide 200
 Cable glands
 – EMC 183
 Cable ties 205
 Cage nut 171
 Castors 96
 Central earthing point 187
 Circuit-breaker module ISV 191
 Clamp rail for cables 204
 Climate control doors 121
 Combination angle 114
 Comfort handle
 – AX 131
 – VX 128
 Component shelf
 – for frame attachment 176
 Connection accessories
 – for LED system light 178
 Connection terminal block ISV 190
 Connector gland 107
 Connector grommets 198
 Contact cutter 183
 Contact hazard protection module ISV 189
 Contact paint 183
 Contact washer 187
 Cover
 – Baying, top 114
 – Baying, vertical 114
 Cover plate
 – for connector cut-outs 107
 Cover strips ISV 194
 Cover with door 107
 Crane bracket 114
 Cross member
 – Adjustable 94
 Cross rail 195
 Cross-brace
 – for mounting plates 154

D

Depth extension frame ISV 194
 Depth stay 195
 Disconnect cross-member ISV 190
 Distribution enclosure VX25 70
 Divider panel 104
 – for module plates 105
 Divider panel seal, EMC 181
 Door latch
 – for bayed suites 109
 Door stay for escape routes 136
 Door-operated switch
 – for LED system light 178
 Drawer 125
 – 482.6 mm (19") 140
 Dust guard trim 144

E

Earth clamp, EMC 183
 Earth strap 186
 Earthing braid 186
 Earthing point, central 187
 Earthquake base/plinth 185
 Earthquake kit 185
 Electronic enclosure VX25 68
 EMC
 – Cable gland 183
 – Earth clamp 183
 – Gland plate 182
 – Shield bus 182, 183
 – Shielding bracket 182
 – Side panel 181
 EMC divider panel seal 181
 EMC shielding seal 181
 Enclosure
 – Key 130
 Enclosure baying system, stainless steel 75
 Enclosure internal thermostat 180
 Enclosure systems
 – Baying enclosure system VX25, sheet steel 54
 – Baying enclosure system VX25, stainless steel 75
 – Fuse-switch-disconnector enclosure 73
 – VX25 distribution enclosure 70
 – VX25 electronic enclosure 68
 – VX25 modular enclosure 71, 72
 – VX25 with glazed door 66
 – VX25, IP66/NEMA 4 69
 – VX25, IP66/NEMA 4X 79
 Enclosure systems VX25, EMC enclosure 74
 Enclosures
 – Door latch 109
 – Isolator door cover 108
 – VX25 distribution enclosure 70
 – VX25 electronic enclosure 68
 – VX25 modular enclosure 71, 72
 – VX25 with glazed door 66
 – VX25, IP66/NEMA 4 69
 – VX25, IP66/NEMA 4X 79
 – VX25, sheet steel 54
 – VX25, stainless steel 75
 Entry grommets for cables 198
 Entry grommets for connectors 198
 Equipment support connector 195
 Eyebolts 145

F

Feet 96
 Filter mat 94
 Fold-out tray 140
 – for keyboard and mouse 140
 Front trim panels
 – Bottom 124
 – Top 124
 Fuse-switch-disconnector enclosure 73

G

Gland plate	
– EMC	182
Gland plates	98
– for cable entry	147
Glazed door	118
Grommets	
– for cable entry	198
– for connector entry	198
Guide	
– for mounting plate	154

H

Handle	
– Comfort handle AX	131
– for mounting plates	158
Hinge attachment	
– for partial mounting plate	157
Hinges	
– 180°	119, 210
– for side panel, screw-fastened, sheet steel	103
Holder	
– for cable conduit	205
– for protective bar	119
Hygrostat	180

I

Identification strip	139
Inlay for plastic gland plate, modular and sealing frame, modular	201
Installation kit	
– for back-to-back mounting plates	153
– for swing frame, large	210
– for swing frame, small, and partial mounting plate	208
Installation modules ISV	188
IP66/NEMA 4, VX25	69
IP66/NEMA 4X, VX25	79
Isolator cap for screw head	203
Isolator door cover	108
ISV distribution enclosure VX25	70
ISV installation kit	188
ISV installation modules	188

L

Large enclosure	
– Baying enclosure system VX25, sheet steel	54
– Baying enclosure system VX25, stainless steel	75
– VX25 distribution enclosures	70
– VX25 electronic enclosure	68
– VX25 modular enclosure	71, 72
– VX25 with glazed door	66
– VX25, IP66/NEMA 4	69
– VX25, IP66/NEMA 4X	79
LED system light	177
– Accessories	178
Levelling component	93
Levelling feet	96
Lights	
– LED system light	177
Lock components	118
Lock insert	129
Lockable and adjacent door	118
Locking bar latch	128

M

Meter mounting board module ISV	192
Modular climate control concept	
– Climate control doors	121
– Cooling module	120
Modular enclosure VX25	71, 72
Modular front design	122
Module plates	106
Mounting angles	195
– C rail	167
Mounting bracket	169
Mounting clip	168
Mounting kit	
– Connection terminal block	190
– for LED system light	179
– Magnet	179
Mounting plate	
– Accessories	151
– Locatable	168
– Screw-fastened, large	169
– Screw-fastened, small	169
– with integral top-hat rail	169
Mounting plate attachment	
– Type A	151
– Type B	152
– Type C	153
Mounting plate infill	151
Mounting plate modules ISV	189
Mounting plates	
– Cross-brace	154
– Mounting positions	150
– Slide rail	154
– Transport handle	158
Mousepad	
– Support	140
Multi-function mounting kit	154
Multiple lock	130
Multi-tooth screw	172, 212

N

NH fuse-switch	
– disconnecter modules ISV	190
NH slimline fuse-switch	
– disconnecter modules ISV	191
Nut	171

P

Paint	95
Partial assembly plate VX	160
Partial door	123
Partial mounting plate	155
Partial mounting plate holder	158
PE busbar	186
Perforated mounting strips	
– for partial doors	124
Plate	
– for base mounting	92
Pressure stoppers	
– for roof plates, for pressure relief	147
Primer/paint	
– Contact paint	183
Protective bar	119
Punched rail	
– 18 x 39 mm	166
Punched section with mounting flange	
– 14 x 39 mm	134
– 18 x 64 mm	164
– 23 x 64 mm	164
– 23 x 89 mm	165
Punched section without mounting flange, 23 x 64 mm	165

Q

Quick-assembly block	170
Quick-fit baying clamp, one-piece	113

R

Rail	
– for EMC shielding bracket and strain relief	182
Rail mounting bracket	171
Ride-up roller for door	136
Roof plate	146

S

Safety lock	130
Screws	172, 212
Seal inserts for plastic gland plate, modular and sealing frame, modular	201
Sealing frame, modular	201
Section for cable entry	
– Centre	199
– Rear	199
Self-tapping screw	172
Serial installation device module ISV	189
Sheet steel	
– Baying enclosure system VX25	73
– Baying enclosure system VX25, basic enclosure with glazed door	66, 67
– Baying enclosure system VX25, EMC enclosure	74
Shield bus, EMC	183
Shielding seal, EMC	181
Shipping brace	137
Side panel	
– EMC	181
– for cable chamber	95
– for top-mounting module	145
– Screw-fastened, sheet steel	102
– Screw-fastened, stainless steel	102
Slide rail	
– for mounting plate	154
– for swing frames	210
Slide rail VX	
– for adaptor section 482.6 mm (19")	212
Sliding panel	98
Socket box	
– for LED system light	179
Spacers	134
– for roof plate	145
Spare key	130
Stainless steel	
– Baying enclosure system VX25	75
– Viewing window	139
Stay	
– for door	136
– for door and escape routes	136
Stay for trim panel, hinged at the top	125
Stepped collar	202
Storage box	135
Strap, earth strap	186
Support	
– for mousepad	140
Support rail	
– 48 x 26 mm	167
– 65 x 42 mm	168
– 75 x 20 mm	167
– TS 35/15	168
– TS 35/7.5	168
Support rail module ISV	189
Support strip	166
Swing frame	208
– 180° hinge	210
– Large	209
– Small	208
– Stay	210
System divider	97
System window	138

T

T distributor for LED system light	178
Technical information	213, 215
Thermostat	
– Enclosure internal thermostat	180
Threaded block	171
Top-mounting module	144
Transport and mounting handle	137
Transport bracket	114
Transport castors	
– for base/plinth VX	92
Transport handle for mounting plates	158
Trim panel	
– Bottom	124
– Hinged at the top	125
– Top	124
Twin castors	96

U

Utility lectern	134
-----------------	-----

V

Viewing window	
– Stainless steel	139
VX25	
– Basic enclosure with glazed door	66
– Baying enclosure system, sheet steel	54
– Distribution enclosure	70
– Electronic enclosure	68
– EMC enclosure	74
– Enclosure, sheet steel	54
– Enclosure, stainless steel	75
– Fuse-switch-disconnector enclosure	73
– IP66/NEMA 4X	79
– Modular enclosure	71, 72

W

Wall bracket	145
Washer, contact washer	187
Windows	
– System window	138
– Viewing window	139
Wiring bracket	194
Wiring plan lectern	135
Wiring plan pocket	
– Plastic	135
– Sheet steel	135
– with transparent pouch	136

We reserve the right to further developments and technical modifications of our products. Such modifications, along with errors and printing errata, shall not constitute grounds for compensation. We refer customers to our Terms of Sale and Delivery.

Rittal – The System.

Faster – better – everywhere.

- Enclosures
- Power Distribution
- Climate Control
- IT Infrastructure
- Software & Services

You can find the contact details of all Rittal companies throughout the world here.



www.rittal.com/contact

XWWW00145EN2208

ENCLOSURES

POWER DISTRIBUTION

CLIMATE CONTROL

IT INFRASTRUCTURE

SOFTWARE & SERVICES



FRIEDHELM LOH GROUP