

Rittal – The System.

Faster – better – everywhere.



SYSTEM 36 CATALOGUE

ENCLOSURES

POWER DISTRIBUTION

CLIMATE CONTROL

IT INFRASTRUCTURE

SOFTWARE & SERVICES

FRIEDHELM LOH GROUP



Complex made simple

Eplan and Rittal are powerful partners in the game plan to optimise and streamline value chains. Our solutions speed up your processes and boost your productivity.

Your value chain is optimised and streamlined at every stage in the process, from engineering, purchasing and manufacturing, through to operations and IT. We support you to emerge as a winner through process streamlining in the goal to achieve the new Industry 4.0 standard.

Our approach is simple: The solutions our customers need tomorrow have been developed by us yesterday and are already in stock today.

Our thinking is in sync with your processes.

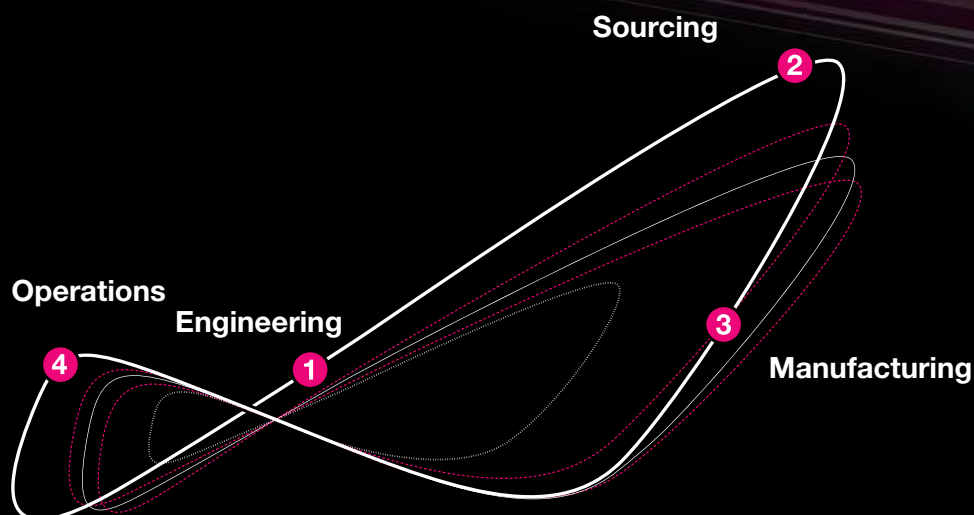

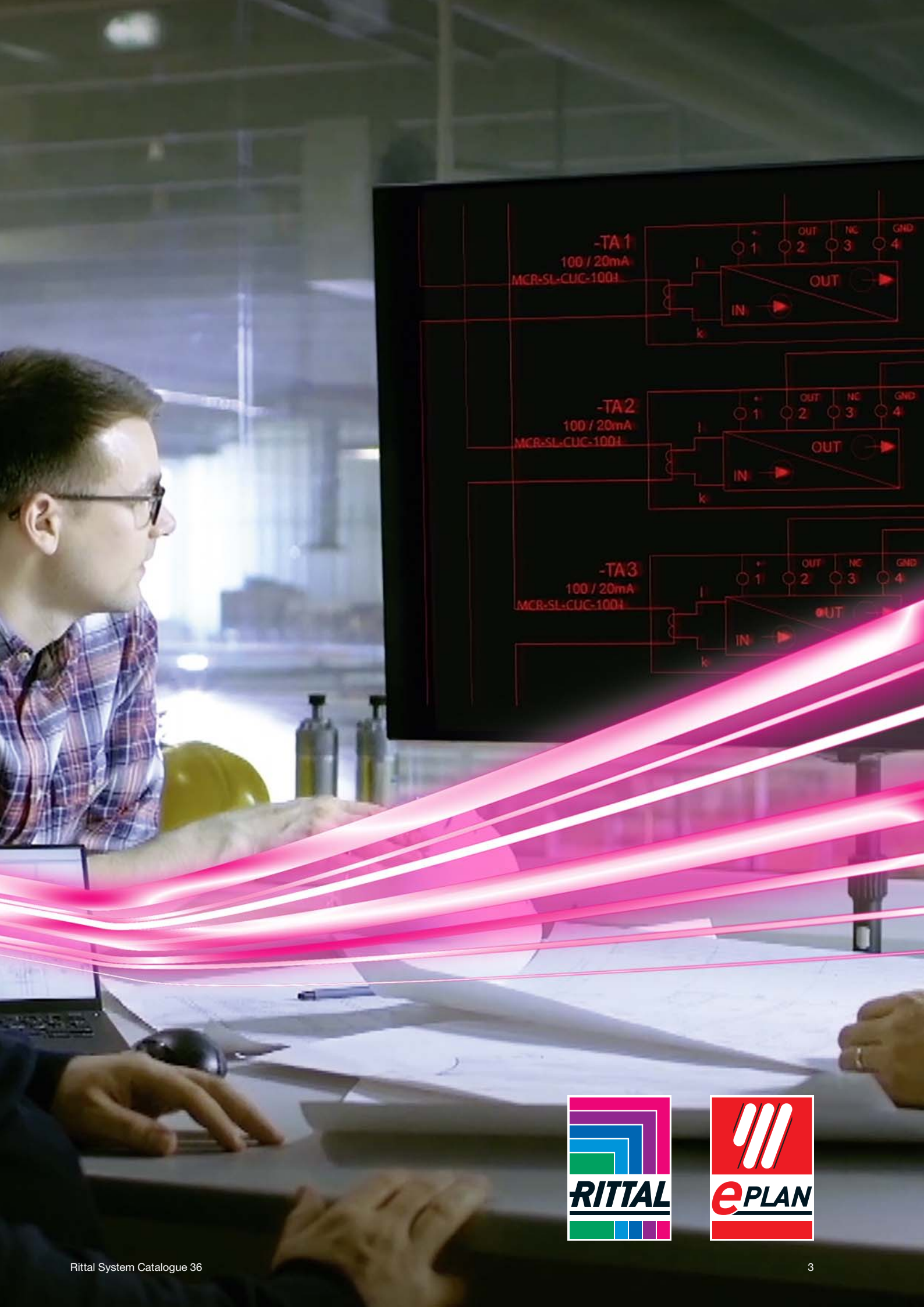

-TA1
100 / 20mA
MCR-SL-CUC-1001

-TA2
100 / 20mA
MCR-SL-CUC-1001

-TA3
100 / 20mA
MCR-SL-CUC-1001



1 Engineering

Digitisation and prototyping boost productivity

The key to greater productivity in enclosure manufacturing lies in digital integration and end-to-end data transfer across the entire value chain. Digital prototyping from the outset, with the digital twin at its heart, provides the basis for rapid links between processes, systems and beyond.

The complete range of Eplan and Rittal tools is available to you for every aspect of engineering. Up-to-date product data from Rittal and other manufacturers can be accessed quickly via the EPLAN Data Portal. With EPLAN Pro Panel, you are ideally equipped for the future with 3D-assisted design.



Technical Specs



Mechanical Infrastructure



Technical Consulting & Design

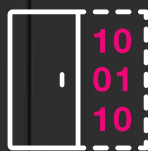

Digital Twin



Product Functions Design



Thermal Design & Dimensioning



Checking & Correcting

Find your solution from page 18 onwards.



2 Sourcing

Do it faster, with configuration aids and our online shop

The Rittal Configuration System allows you to select your racks and enclosures quickly and easily at the click of a button, and then order them directly from the online shop. What's more, you benefit from error-free product & accessory configurations and detailed mechanical plans. It's never been easier to configure and order your perfect solution!

As an innovative and technological leader, Rittal uses automated production techniques based on Industry 4.0 principles to manufacture its world-leading products. Our mission is to manufacture rack and enclosure systems as efficiently and perfectly as possible, as at the digitally integrated Rittal plant in Haiger, for example.

Standard products are delivered within 24/48 hours in Germany/Europe, in line with our brand promise: "Rittal – The System. Faster, better, everywhere."



Ordering



Manufacturing Documents



Logistics



Kitting

Find your solution from page 1160 onwards.



RITTAL

MAN

RITTAL



3 Manufacturing

Do it better with Industry 4.0 and automation

For customised machining of racks and enclosures with the same standards of precision and quality of volume production, Rittal offers fully automated machines for machining, component mounting and wire processing. EPLAN Smart Wiring makes wiring easier than ever before. All work stations are interlinked into one seamless, efficient process using data from the virtual prototype.

Rittal Automation Systems supplies all the automation support you need for faster, easier and more accurate panel building that can be duplicated time and again – your ideal workflow from a single source.



Cutting



Labeling Devices

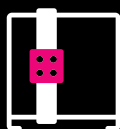

Panel Modification



Wire Fabrication

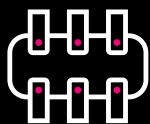

Terminal Strip Assembly

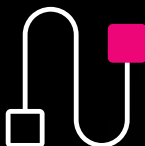

Wiring

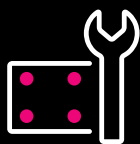

Mechanical Installation



Testing

Find your solution from page 560 onwards.





Wire Terminal >>
WT 36



4 Operations

Do it more reliably with our smart, global service

We're there for you, whether you are looking to replace vital cooling unit components or your systems need an efficiency check.

After commissioning, machines and systems must ensure reliable long-term operation as the key to efficient, high-performance production. Keep an eye on the status of your current project data, from any location, with the cloud-based solution EPLAN eVIEW. And use the Rittal global service to minimise downtime and boost efficiency.

We think ahead: With IoT links to our cooling units and chillers, for example, predictive maintenance is already a reality.



Operations



Service

Find your solution from page 1132 onwards.

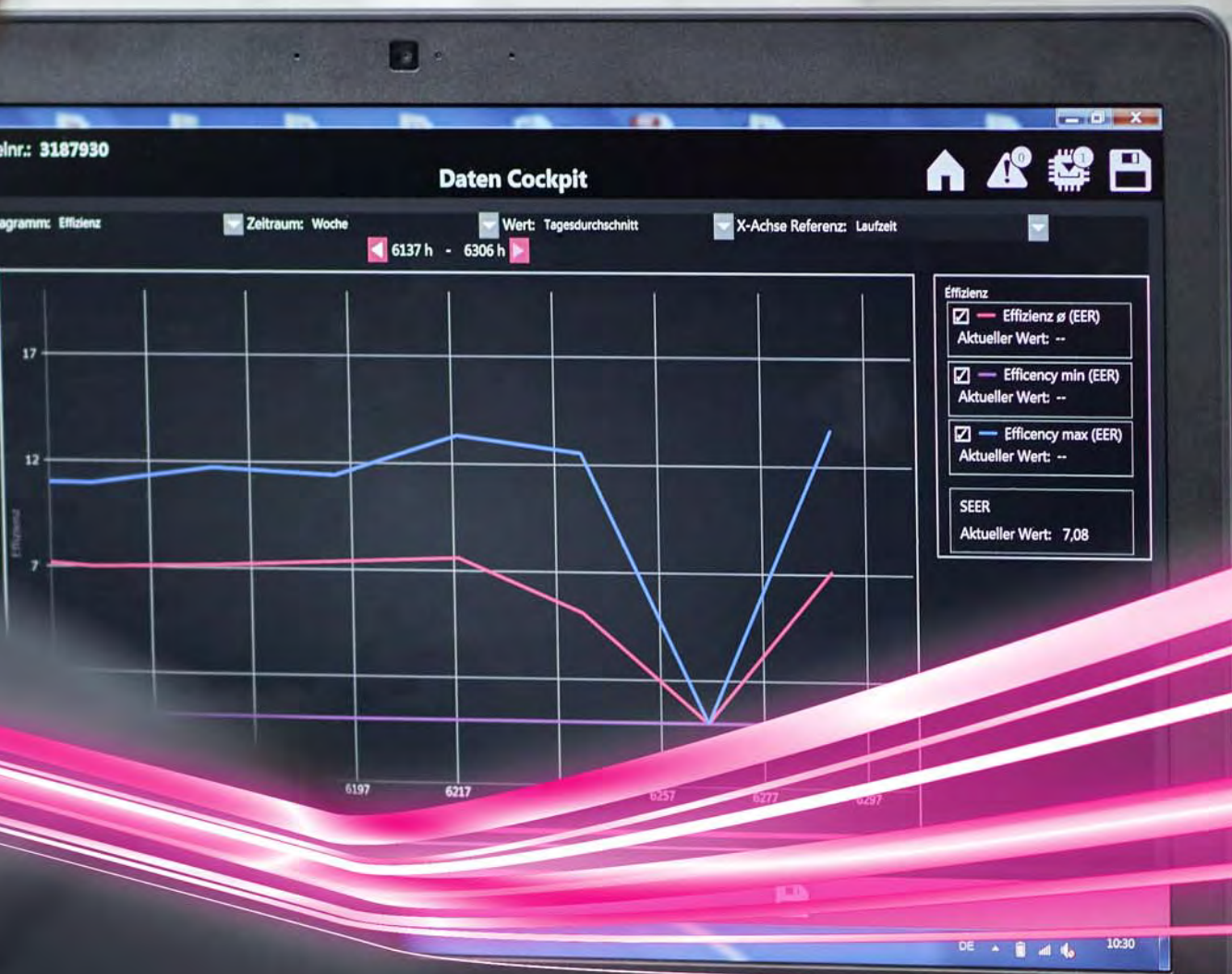

Become more future-proofed

With the IT platform and edge cloud technology

The latest IT technologies and applications – from cloud and edge computing, to analytics and AI, through to 5G – will shape the production of the future.

Processing production data in real time, while ensuring data sovereignty and value creation, is a breeze with the turnkey edge cloud data centre ONCITE.

What is more, the Rittal IT platform with its modular system design will help you to master all IT scenarios quickly and easily, from rack installations through to edge and hyperscale data centres.



Monitoring



Data Analysis



Find your solution from page 834/661 onwards.



Be more competitive

With know-how and interplay

Combining engineering solutions from Eplan with system and automation expertise from Rittal will help to optimise and streamline your panel building and switchgear manufacturing processes across the entire value chain.

Invest in your future with Eplan and Rittal.
The future has arrived.

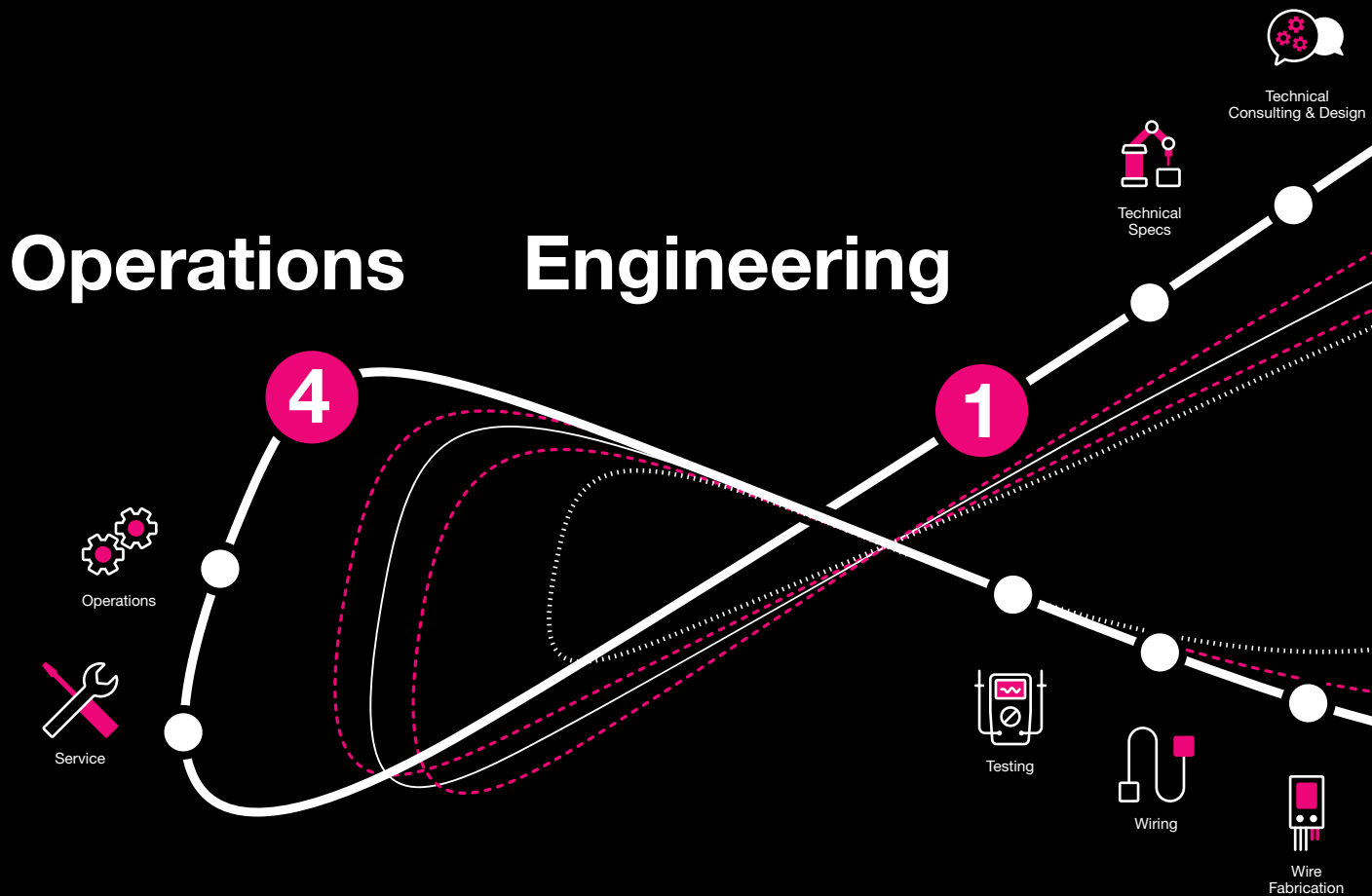

Sourcing

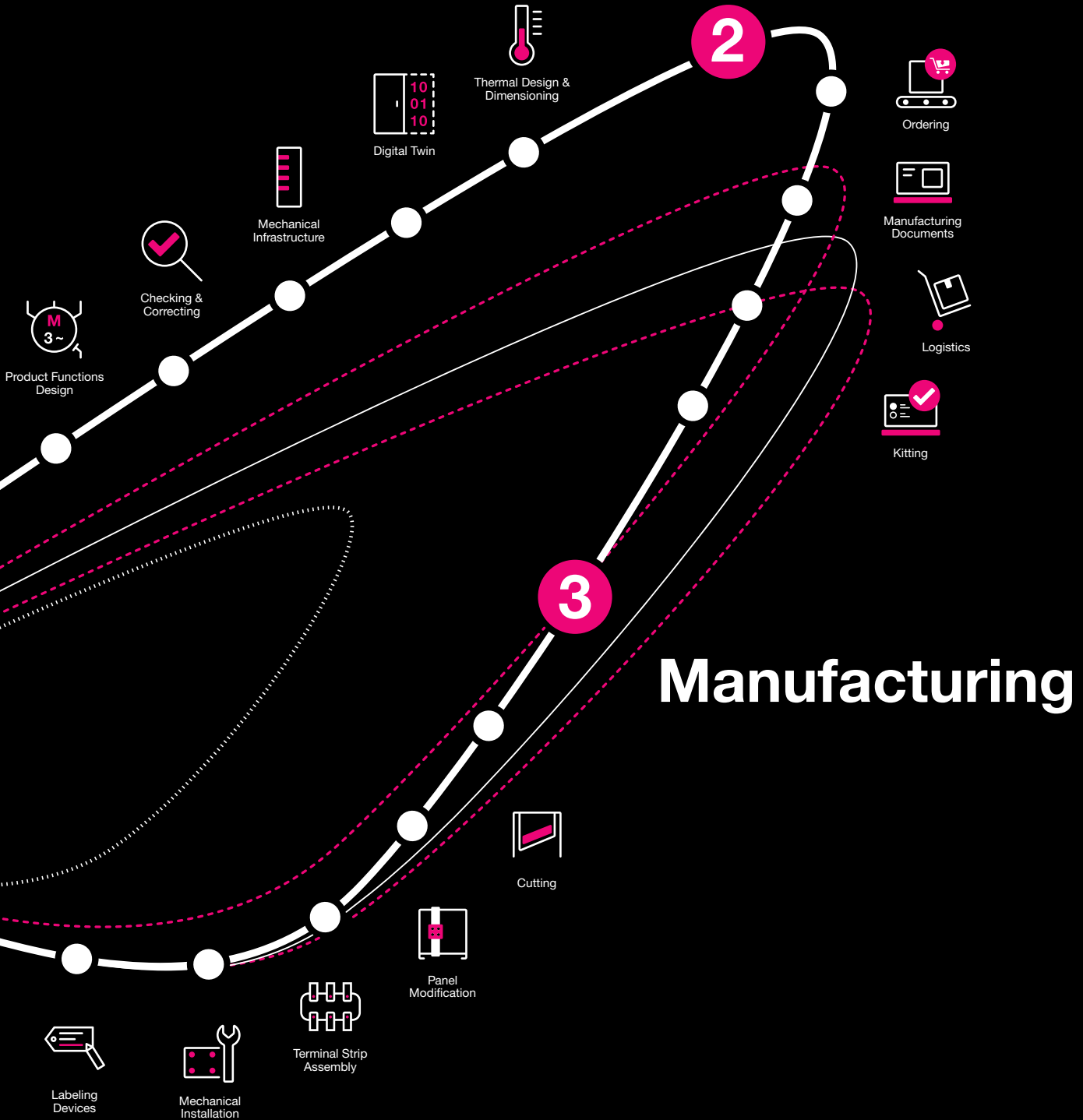

Manufacturing



Rittal – The System.

Faster – better – everywhere.



ENCLOSURES

POWER DISTRIBUTION

CLIMATE CONTROL

FRIEDHELM LOH GROUP



Engineering	from page 18
Eplan.....	18
Enclosures	from page 39
Small enclosures	43
Compact enclosures	73
Enclosure systems	99
Console systems/PC enclosure systems/IW.....	149
Operating housings/support arm/stand systems	169
Support arm systems.....	183
Hygienic Design	217
Stainless steel	227
Ex enclosures.....	257
Outdoor	263
Power distribution	from page 277
Busbar systems	281
RiLine.....	299
VX25 Ri4Power	361
VX25 Ri4Power ISV distribution enclosures	419
Climate control	from page 449
Air cooling	453
Cooling units	473
Liquid cooling.....	509
Enclosure heaters	530
Climate control accessories.....	532
Rittal Automation Systems	from page 561
Tools.....	564
Handling.....	606
Wire processing and wiring	632
Machining	638
Machines for machining, wire processing and assembly	650
IT infrastructure	from page 661
IT rack systems/racks	673
IT power.....	723
IT cooling	757
IT monitoring	799
IT security solutions.....	833
System accessories	from page 877
Service & quality	from page 1133
International service.....	1134
Rittal Manufacturer's Service	1140
Smart Service.....	1150
Quality management	1154
Software & services.....	1156



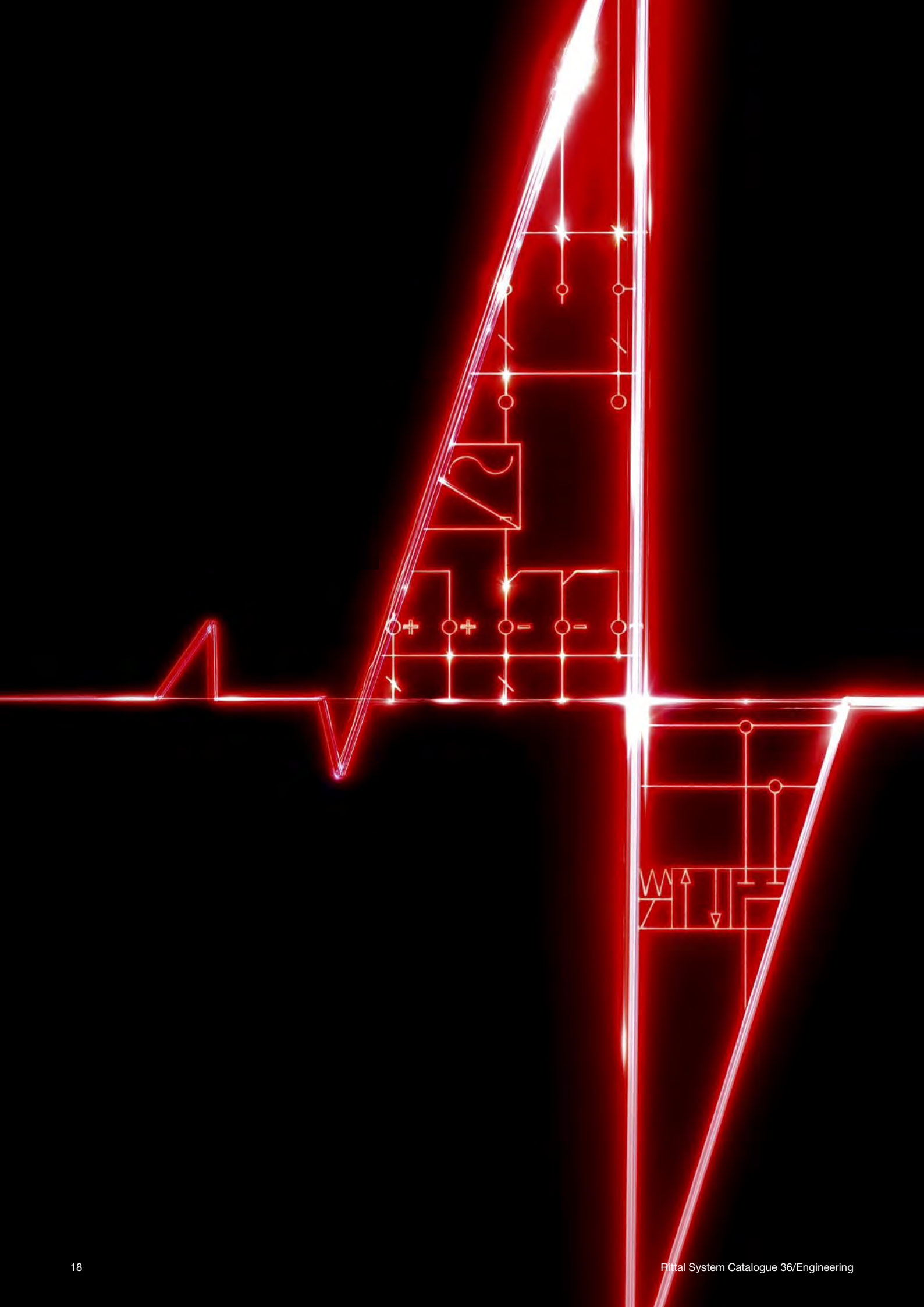

Engineering

The Eplan process at a glance.....	20
EPLAN Solutions – Your Gateway to Greater Efficiency.....	22
Engineering with its finger on the pulse.....	24

The EPLAN solutions

EPLAN Cogineer	26
EPLAN Engineering Configuration (EEC)	27
EPLAN Preplanning	28
EPLAN Fluid	29
EPLAN Electric P8.....	30
EPLAN Pro Panel.....	31
EPLAN Smart Wiring	32
EPLAN Harness proD	33
EPLAN ERP/PDM Integration Suite.....	34
EPLAN Data Portal	35
EPLAN eBUILD	36
EPLAN eVIEW	37

Eplan delivers software and service in all fields of electrical engineering, automation and mechatronics. We have developed one of the world's leading software solutions for mechanical & plant engineering and enclosure manufacturing.

“Efficient engineering” is our motto. When it comes to streamlining challenging engineering processes, Eplan is your ideal partner. Whether you are a small or a large company, we can help you deploy your expertise more efficiently.



THE EPLAN PROCESS AT A GLANCE

When it comes to your design, engineering and manufacturing tasks, having the correct expert systems is one thing. But what about the connections between the systems?
And the single source of truth (SSOT)?

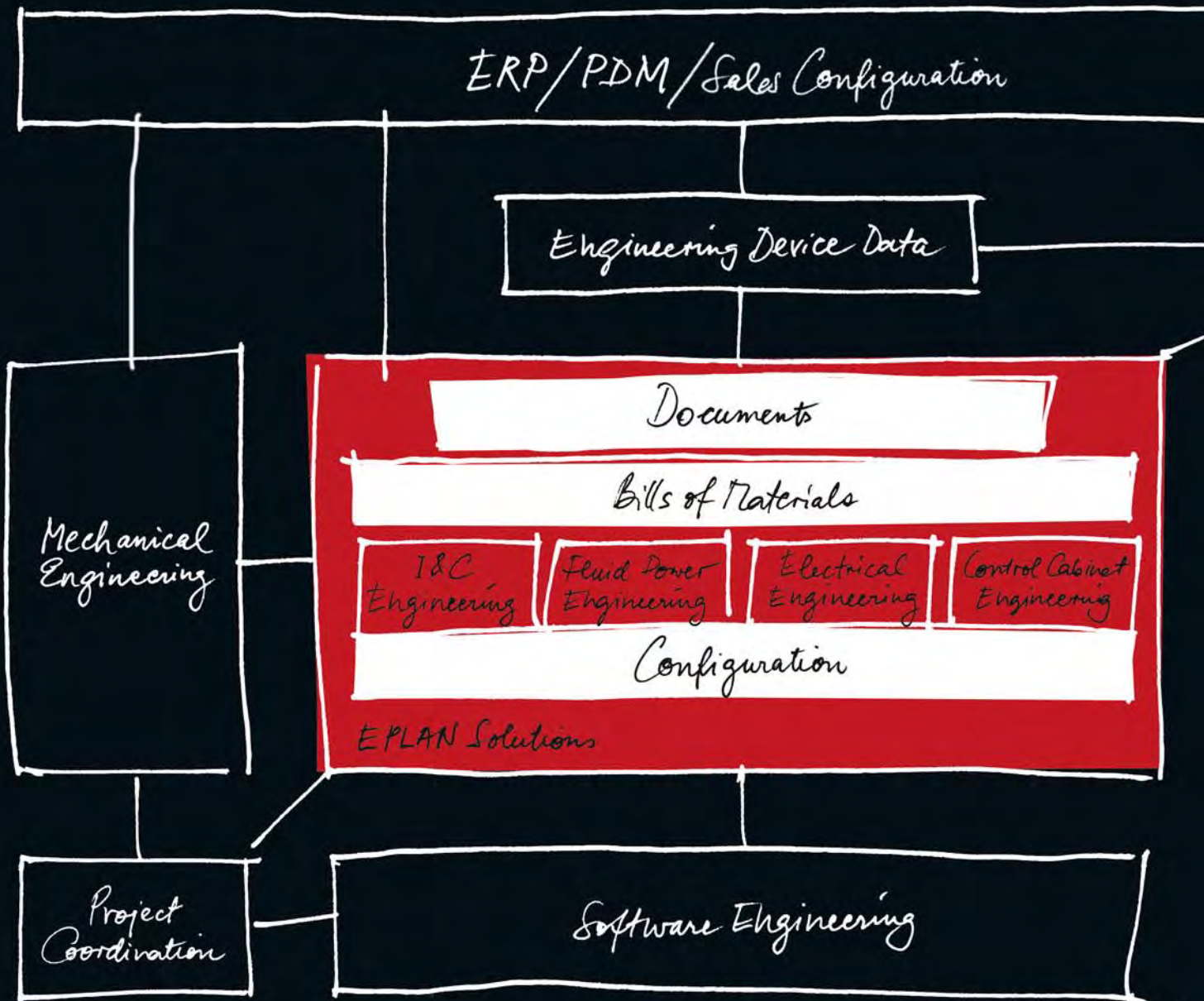



We examine your process, across the full range of different operations to optimise greater efficiency and data continuity:

- Interdisciplinary communication
- Macros and configuration
- Two-way data exchange
- Interfaces to ERP/PDM
- Data forwarding to enclosure manufacturing
- Efficiency via cloud solutions

From engineering to production

One thing is clear: the greatest potential for efficiency improvements lies in the process. Smooth interactions between all systems, from engineering through to production, are the key to creating more value.

Aim for reuse

Similarly, structuring your projects and templates correctly will significantly enhance the opportunities to reuse them. We can help you!

A standardised database for your project

At the start of any project, you should ask yourself: Which components do we need for planning? The EPLAN Data Portal can supply these components and complete your data in a logical fashion.

EPLAN

efficient engineering.

EPLAN SOLUTIONS – YOUR GATEWAY TO GREATER EFFICIENCY

EPLAN helps you to develop a cross-disciplinary approach to your engineering.

The EPLAN platform provides the basis for this, by linking our software solutions together. For you, this translates into significant efficiency gains when working on your EPLAN project, because your digital data flows seamlessly from solution to solution, becoming further augmented with every process step.

EPLAN ePULSE additionally provides access to an innovative cloud system, genuinely adding value to multi-location projects, for example.

The EPLAN platform and EPLAN ePULSE combine to create EPLAN Solutions, your key to cutting-edge advanced engineering.



“By digitizing your processes and standardizing your data, you will retain a long-term competitive edge.

We can support you, with open systems and professional advice to safeguard your efficient engineering for the future.”

Bernd Schewior,
Vice President Professional Services EPLAN

ENGINEERING WITH ITS FINGER ON THE PULSE

EPLAN platform

The EPLAN platform combines software solutions for every engineering discipline, from pre-planning, to project management, through to the construction of switchgear and cable harnesses. It comprises:

- Automated Engineering: EPLAN Engineering Configuration (EEC) provides you with a versatile tool for the design and use of configuration interfaces. EPLAN Cograeer provides you with the basis for automated generation of wiring schematics.
- EPLAN Preplanning helps you to record engineering data even at the preplanning stage.
- EPLAN Fluid is your engineering tool specifically designed for the project management and automatic documentation of circuits for fluid engineering systems.
- EPLAN Electric P8 helps you project-plan your electrical design for machinery and equipment in an engineering solution at the heart of the EPLAN platform.
- With EPLAN Pro Panel you devise and design control cabinets, switchgear and power distribution systems for energy supply in 3D.
- Use EPLAN Harness proD for efficient design and documentation of cables and cable harnesses in 3D and 2D.

EPLAN ePULSE



Mechanical
Engineering



Automated
Engineering



EPLAN
Preplanning



EPLAN
Fluid



EPLAN
Electric P8



EPLAN
Pro Panel



EPLAN
Harness proD



Software
Engineering



ERP/PDM



EPLAN solutions



EPLAN Cogineer

Maximise the potential of your engineering in next to no time with EPLAN Cogineer and boost the quality of your electrical and fluid documentation. Use your existing circuit templates to build a macro-library, and generate wiring schematics automatically at the click of a button with EPLAN Cogineer. What is more, you will benefit from the innovative techniques and add value to your engineering without a lengthy implementation process, across all industries and in companies of all sizes. With EPLAN Cogineer you can now compile circuit diagrams from a template library with just a few clicks directly from your Web browser.

Users of EPLAN ePULSE have automatic access to a free premium version of EPLAN Cogineer if already working with the Eplan platform.

FAQs

■ How will EPLAN Cogineer improve the quality of my projects?

EPLAN Cogineer is based on the standardised reuse of Eplan macros. Once correctly created, they work like a high-quality library, thus avoiding typical copy-and-paste errors. This saves time and money.

■ Do I need extensive prior knowledge to be able to work with EPLAN Cogineer?

You do not need expert knowledge of Eplan to be able to generate wiring schematics to the customer's specifications; training is fast and straightforward. Nor do you need any knowledge of advanced programming languages.

■ Can I benefit from EPLAN Cogineer even at the implementation phase?

Yes, because with EPLAN Cogineer you have the option of gradually phasing in versions of automated wiring schematics.

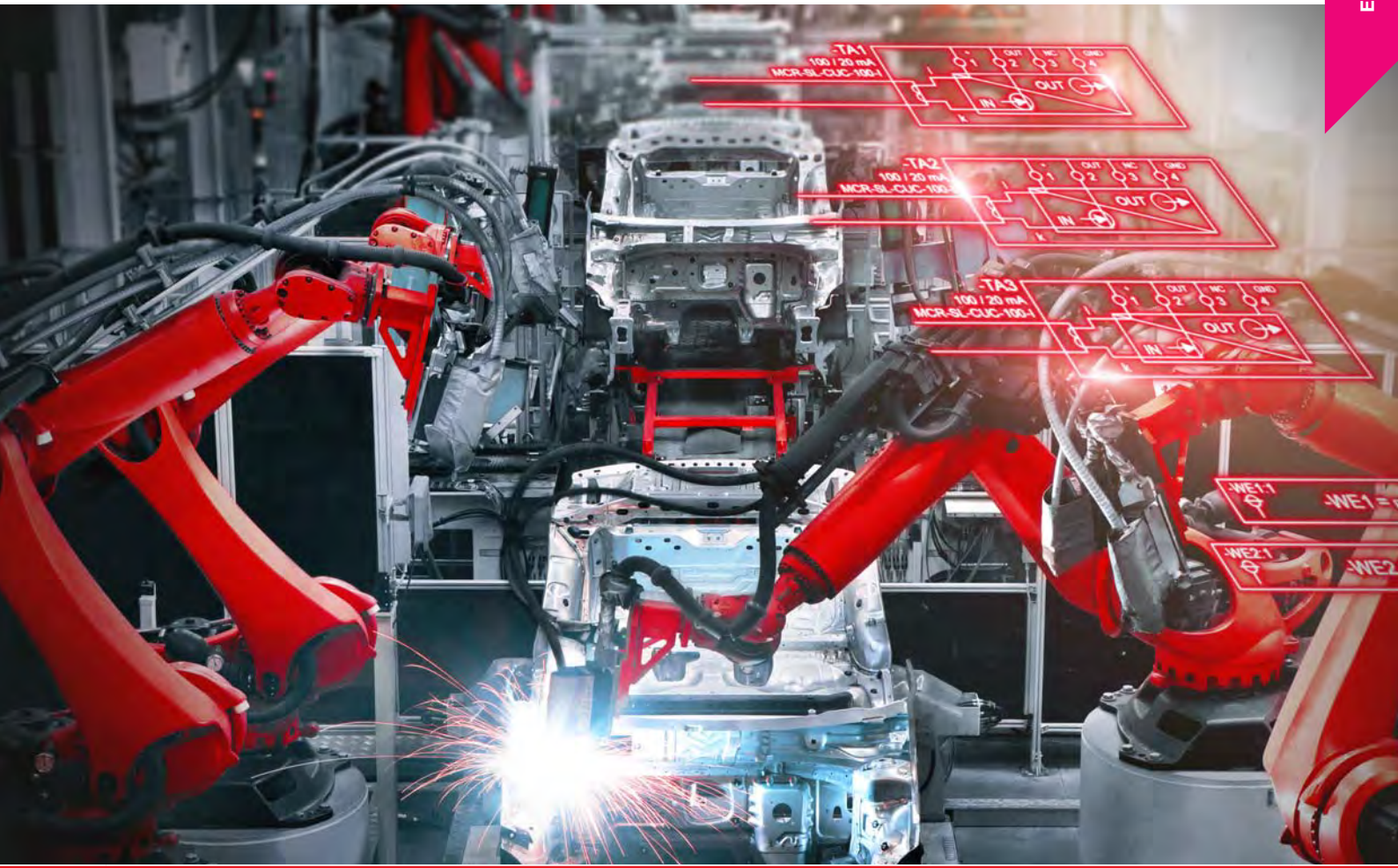

EPLAN Engineering Configuration (EEC)

With EPLAN Engineering Configuration (EEC), you map your product portfolio in a modular system with interdisciplinary functional units. As a result, EEC is your go-to tool for the design and application of configuration interfaces and the automatic generation of documents. This multi-disciplinary approach integrates sales, order processing, mechanical engineering, electrical and control engineering as well as production and documentation. Standardised, recognizable structures also make the commissioning and servicing of your products easier.

Your benefits

- Benefit from automated data reuse with simple product structuring and the creation of modules.
- Save time and money, and optimise the quality of your documentation.
- Significantly shorten your production and delivery times, which in turn will cut project throughput times at your company.
- A wide range of distinct and varied specification parameters are supported and enable the handling of customer-specific requirements.
- EEC can be seamlessly integrated into existing system structures and supports consistent workflows.

EPLAN solutions

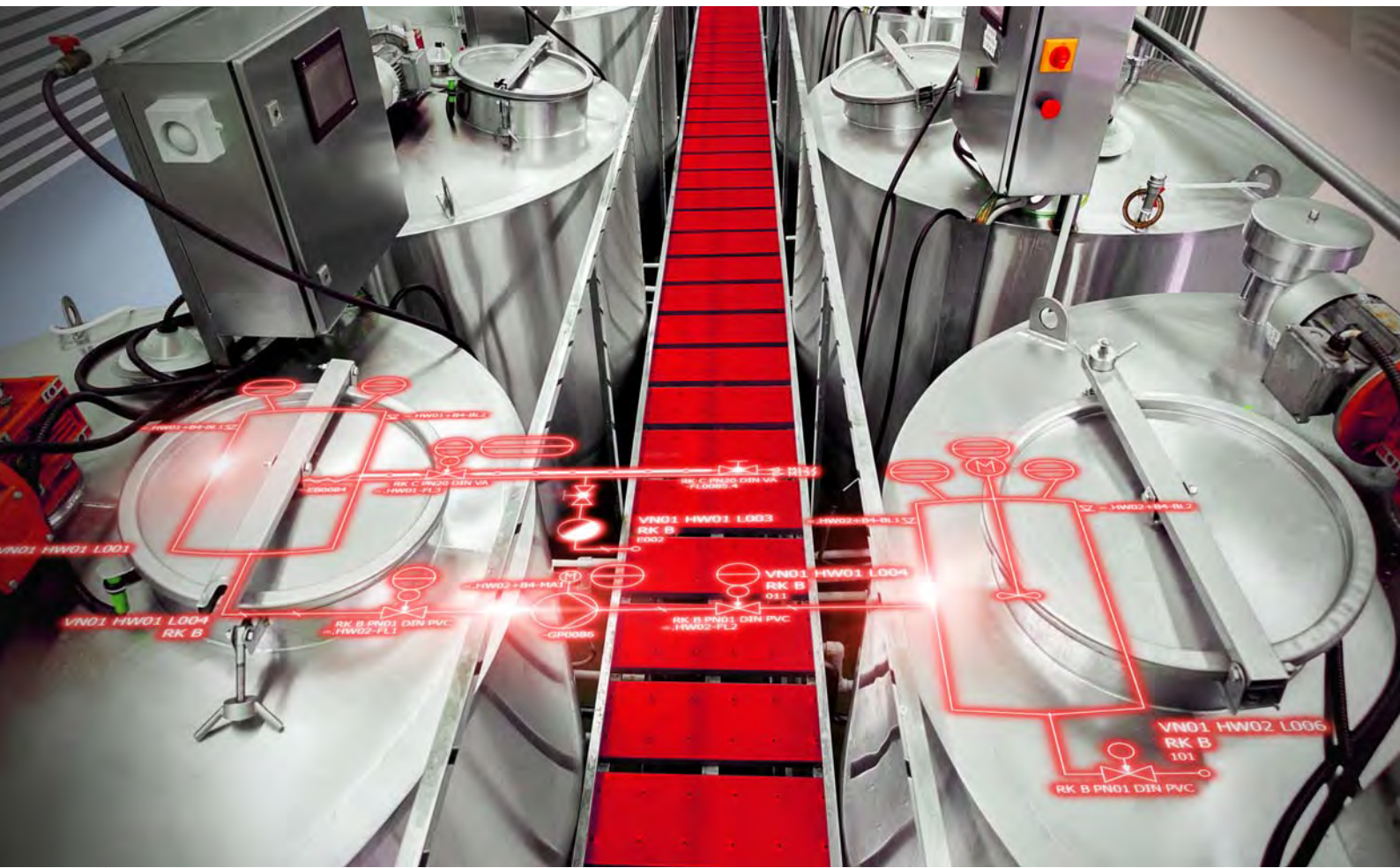

EPLAN Preplanning

EPLAN Preplanning helps you to log your engineering data even at the preplanning stage. For example, this might include the actuators and sensors in a system, machine or building. You can import data from external spreadsheets as well as making a graphical record of plant and machine overviews and process and instrumentation diagrams. This allows you to generate the initial data sheets and specifications for material procurement quickly. Downstream engineering planning phases can also access the collated and augmented data from EPLAN Preplanning.

Your benefits

- You have a clearly structured overview of all plant, machine and building data at all times.
- Engineering data logged early on in the project remains readily accessible to anyone working on the project for its entire duration.
- Preplan basic information such as signal, pipeline and cable data in a graphical format to guide you more easily through the project.
- By using EPLAN Preplanning at the quote preparation phase and seamlessly transferring this information to engineering, you can boost the quality of your data throughout the entire planning process.

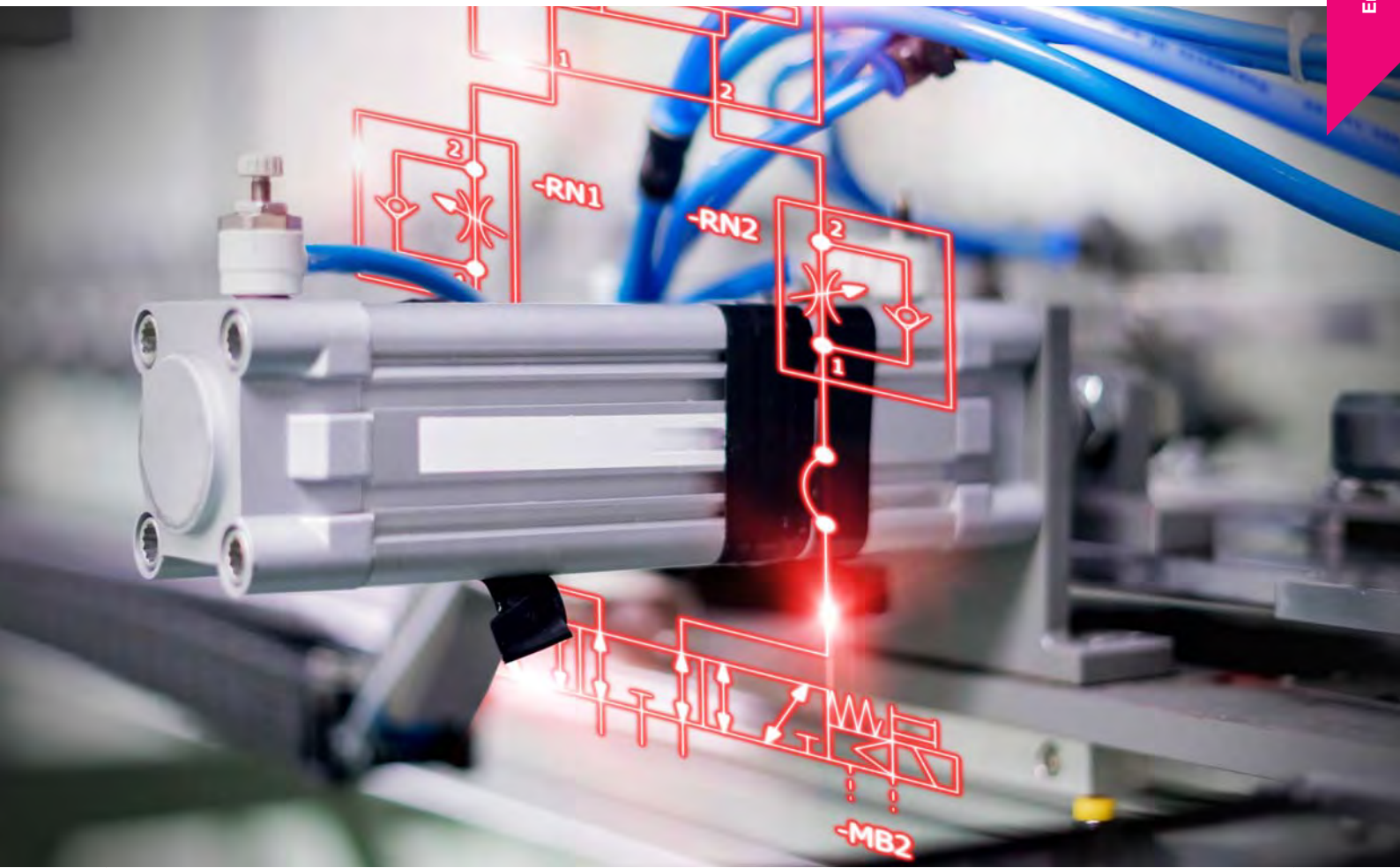

EPLAN Fluid

EPLAN Fluid is your engineering tool specifically designed for the project planning and automatic documentation of fluid circuits in hydraulics, pneumatics, cooling and lubrication. The direct link to the EPLAN platform also allows you to implement tasks from other engineering disciplines in parallel. Planning and production documents are derived from the same source.

Good to know

- Fluid engineering planning with EPLAN Fluid is compliant with the latest standard ISO 1219 or IEC 81346 with a mechatronic approach.
- Standards and expertise are stored in the system as macros for reuse.

EPLAN solutions

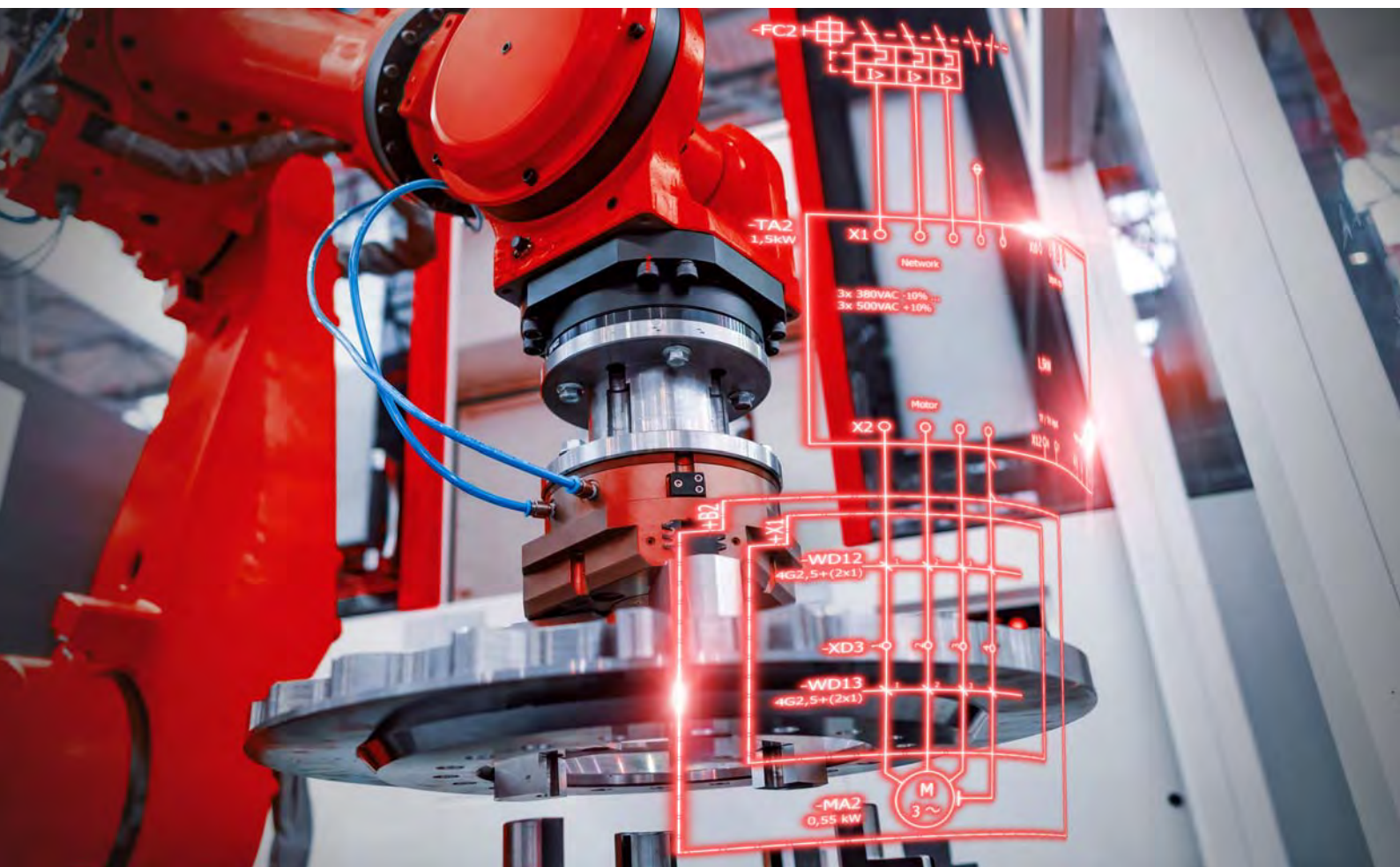

EPLAN Electric P8

EPLAN Electric P8 allows consistent, seamless, fast project planning of your electrical machinery and equipment designs in one engineering system. The software supports a range of engineering techniques, from manual generation through to standardised and template-based approaches. Once recorded in the circuit diagram, the machinery and equipment documentation is auto-completed using the project data. EPLAN Electric P8 automatically generates detailed evaluations on your behalf as an integral part of the project documentation. This can be supplied continuously or bundled at the end of the project, as you prefer. This allows you to supply all downstream process stages with the necessary engineering information: from seamless planning through to production, commissioning, maintenance and repair.

Your benefits

- Switch symbols are logically autoconnected in a flash.
- Choose between a graphical, logical or equipment-based project planning approach to support a variety of work processes.
- Evaluations such as terminal and cable plans or parts lists are generated automatically for you.
- Functions for processing mass data such as “search and replace” or “process in Excel” will accelerate your project planning while at the same time improving quality.

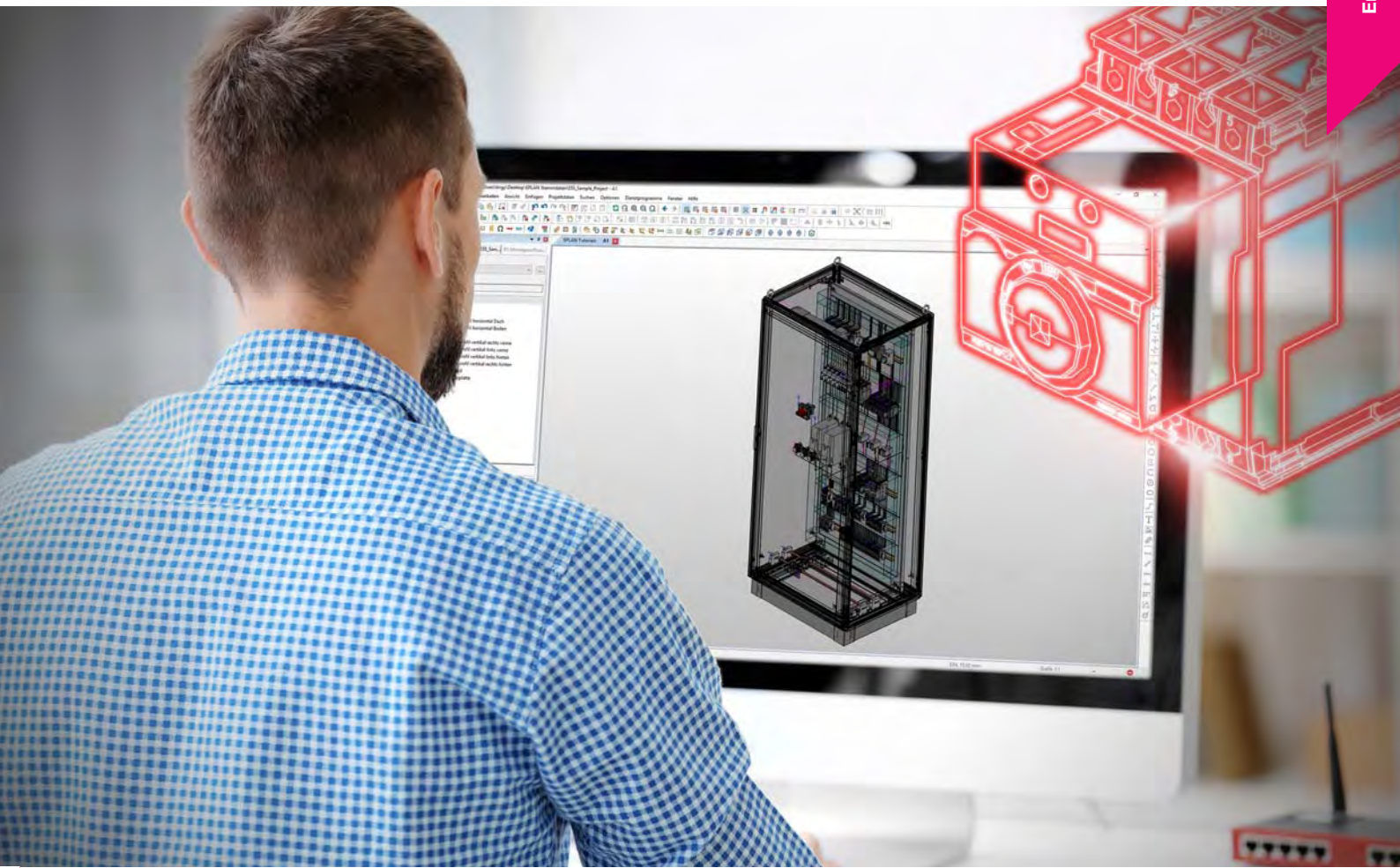

EPLAN Pro Panel

EPLAN Pro Panel Professional allows you to devise and design control cabinets, switchgear and power distribution systems for energy supply in 3D. This means you can solve a wide range of engineering tasks with just one software package: from the creation of electrical circuit diagrams, to planning the installation layout in 3D, through to the virtual laying of connections. What is more, EPLAN Pro Panel Professional allows for comprehensive improvements of the production processes in enclosure and switchgear manufacturing: A wide range of manufacturing data and information is supplied automatically, from component labelling through to support of the manual wiring process. In short, EPLAN Pro Panel Professional provides a solid foundation for the automation and streamlining of your enclosure manufacturing.

Your benefits

- From the creation of circuit diagrams to assembly layout to production integration, a single software package does it all.
- For more automated enclosure production, order information and comprehensive manufacturing documentation can be provided.
- Shorten throughput times and cut costs while maintaining a high standard of quality.
- Work profitably on any unit volume, from specific projects with a batch size of just 1 through to mass production.

www.eplan-software.com/solutions

EPLAN solutions



EPLAN Smart Wiring

EPLAN Smart Wiring is your virtual assistant for manual wiring in enclosure production. From the connection point through to the precise cable route, the software provides wiring experts with all the information they need in digital form, in 3D if required. You decide whether to wire the displayed connections individually or in a preset sequence.

Wiring status can be indicated with the traffic-light principle. If you need confirmation, you can call up the electrical wiring plan to cross-check, starting from each individual connection. Any anomalies can be forwarded directly to the planning department by email. Project data is made available on a central server, allowing you to produce multiple identical enclosures in parallel or collaborate with several wiring experts.

Your benefits

- As a wiring expert, you receive detailed step-by-step instructions for simple usage.
- Wiring without a wiring plan is also possible, this is stored in the assistant.
- Assembly layout, operating equipment, connections, connection setups and cable routes are clearly and comprehensively visualised.
- For any last minute changes, an automatic project adjustment capability helps to prevent errors.
- Status information supports the transfer of the project to several different employees and enables you to monitor the project.

www.eplan-software.com/solutions



EPLAN Harness proD

EPLAN Harness proD is used for the efficient design and documentation of cables and cable harnesses in 3D and 2D. The EPLAN allows you to automate typical work operations in cable and cable harness design – from transferring the connection information from the EPLAN platform, to intuitive cable laying, through to generation of the production documents. The software is open to MCAD systems and is therefore seamlessly integrated into existing system landscapes. The cable and cable harness design does not depend on the availability of a mechanical prototype. You can upgrade the digital twin with the relevant electrical information even during the engineering process.

Your benefits

- The intuitive 3D environment makes it easier for you to design cables and cable harnesses.
- The required production documents including pinboard drawing and cable drawing can be derived automatically. This saves you time and money and enhances the quality of your documentation.
- Electrical pathways are more easily distinguished and wires and cables can be routed automatically.

www.eplan-software.com/solutions

EPLAN solutions

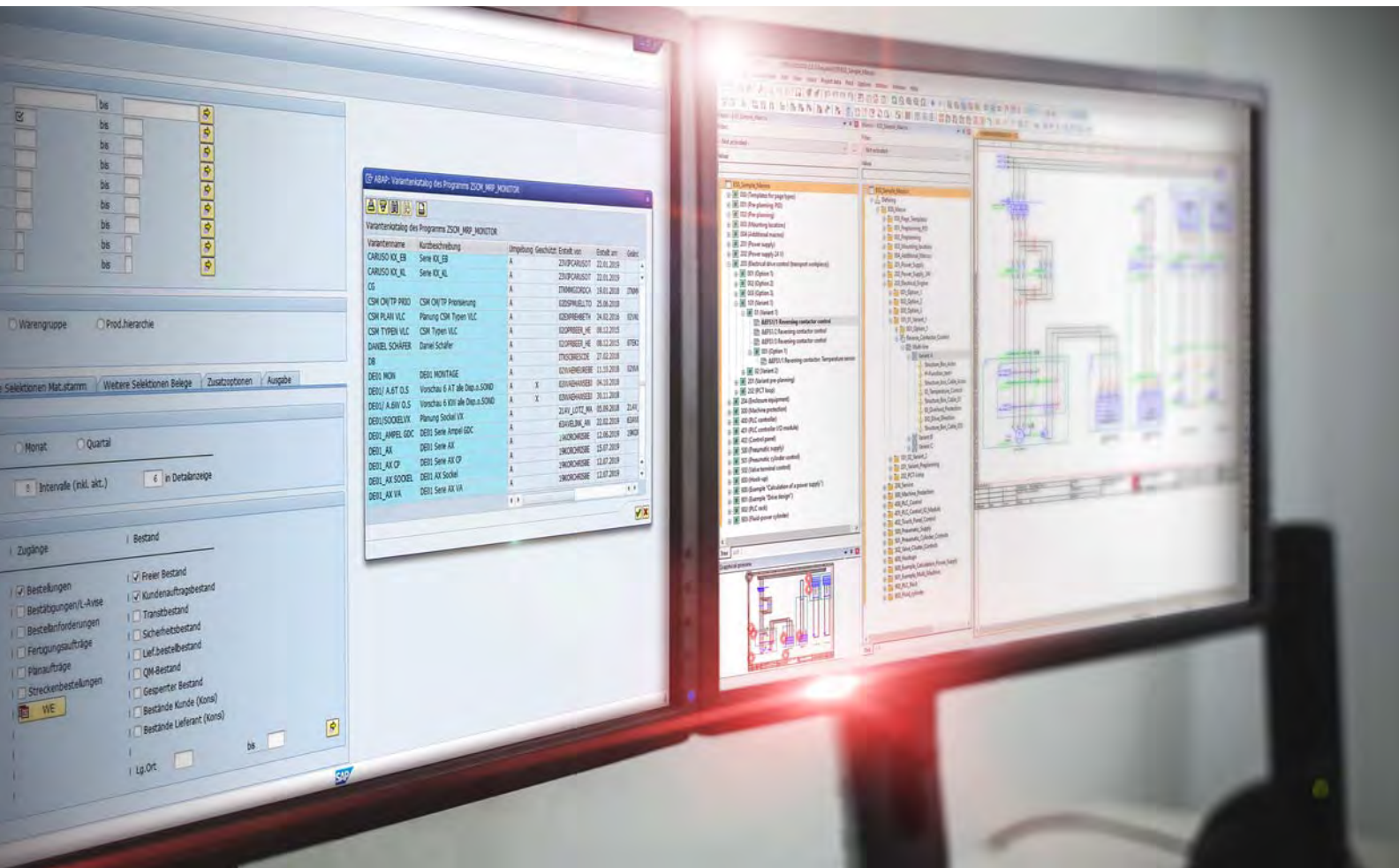

EPLAN ERP/PDM Integration Suite

Seamless data flows ensure transparency in the product development process. The EPLAN Integration Suite supports integration into existing ERP, PDM and PLM system protocols. This helps you to optimise your work processes, from the circuit diagram through to the master data. Fast, specific data is supplied in a two-way exchange with the systems without needing to leave your work space within the EPLAN platform.



EPLAN Data Portal

The EPLAN Data Portal gives you direct online access to high-quality product catalogues from a host of component manufacturers. All products within the EPLAN platform have equal access to this Web service. By dragging and dropping the available components into the EPLAN documentation, you can reduce project planning work and upgrade the quality of machine and system documentation. The time savings achieved with the EPLAN Data Portal at the start of project planning extend right through to commissioning: The representation of a device in various system plans is always based on a uniform source.

Your benefits

- Quickly and easily located standardised, intelligent, globally valid device data.
- Minimise the effort required for master data maintenance.
- Benefit from significant project planning time savings compared with manual generation.
- Significantly enhance the quality of your documentation.

www.eplan-software.com/eplan-data-portal

EPLAN solutions

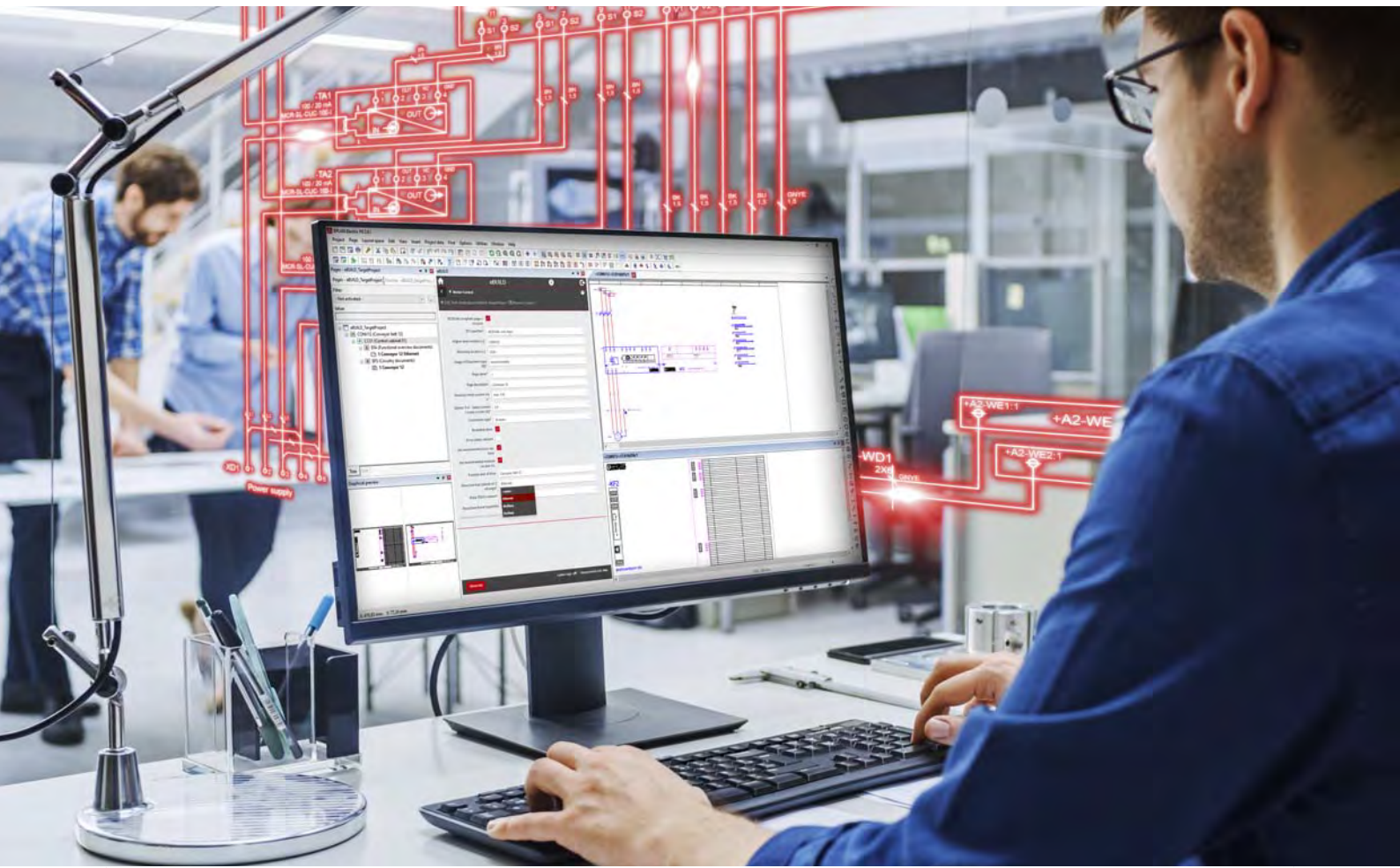

EPLAN eBUILD

EPLAN eBUILD is a member of the EPLAN ePULSE family, which brings together open and cloud-based data and projects, disciplines and engineers worldwide. The automated creation of wiring schematics helps users to take their first steps towards automated engineering.

Your benefits

- Free template libraries, including logic and variance, are available to use.
- Readily available in the Eplan platform (from version 2.8, hotfix 3).
- New template libraries from well-known manufacturers are continuously being added to EPLAN ePULSE as cloud-based options.
- This tool is suitable for universal use across all industries and is international.

www.eplan-software.com/solutions



EPLAN eVIEW

With EPLAN eVIEW, your Eplan project is uploaded to the cloud for you. This means that any data created and added to in the EPLAN platform is evident to everyone involved in the project throughout the entire value chain, from engineering, production and assembly, through to maintenance and servicing. EPLAN eVIEW allows you to view project data from any location via your browser and comment on any amendments. The software guides you easily and intuitively through the redlining process. This enables simple communication and collaboration across different projects, departments and companies, so you can collaborate securely and transparently with different teams, suppliers and service-providers. Everything is paperless, using data directly from the cloud.

Good to know

- EPLAN eVIEW allows you to access and view the status of a distinct EPLAN project at any time.
- Clearly definable access rights ensure data privacy.
- A consistent redlining process supports communication between the engineering team and the local commissioning and servicing teams.
- Cloud-to-cloud: EPLAN eVIEW can also be linked to your own in-house cloud solutions.

Rittal – The System.

Faster – better – everywhere.



ENCLOSURES

POWER DISTRIBUTION

CLIMATE CONTROL

FRIEDHELM LOH GROUP

ENCLOSURES

Small enclosures from page 43

Polycarbonate enclosures PK	44
Cast aluminium enclosures GA	48
Terminal boxes KX.....	56
E-Box KX.....	64
Bus enclosures KX	70

Compact enclosures from page 73

Compact enclosures AX	84
Plastic enclosures AX	94

Enclosure systems from page 99

Baying enclosure system VX25	116
Free-standing enclosure system VX SE.....	142

Console systems/PC enclosure systems/ Industrial Workstations from page 149

TopConsole system TP	156
One-piece consoles TP	161
Universal consoles TP	162
PC enclosure systems	164
Industrial Workstations.....	166

Operating housings/support arm/ stand systems from page 169

Comfort Panel	172
Optipanel.....	174
Operating housings AX	178
Compact Panel.....	181
Support arm systems	183
Stand systems.....	211

Hygienic Design from page 217

Terminal boxes HD	220
Compact enclosures HD.....	221

Stainless steel from page 227

Support arm system CP 40	188
Small enclosures KX.....	230
Compact enclosures AX	236
Enclosure systems VX	242
Console systems	251
PC enclosure systems	252
Operating housings	253

Ex enclosures from page 257

Ex enclosures, stainless steel.....	258
Ex enclosures, plastic	260

Outdoor from page 263

Outdoor enclosures	268
Outdoor project solutions	270

Software for enclosures from page 272

Configurators/tools/CAD data.....	272
-----------------------------------	-----



Enclosures

Rittal – The System.

Faster – better – everywhere.



Product group		Small enclosures	Compact enclosures	Enclosure systems	
		Tough enough to take it all – there are practically no limits to the scope of applications for these especially robust small and compact enclosures. Electrical, electronic and pneumatic components are securely encapsulated with a high IK impact resistance.		Ingenuously simple, fully symmetrical, and patented worldwide – this is the successful formula which has established the VX25/ VX SE as a global standard.	
Material	Plastic	■	■	–	
	Aluminium	■	–	–	
	Sheet steel	■	■	■	
	Stainless steel	■	■	■	
Dimension variants		More than 145 small enclosures and 190 compact enclosures in a range of individual materials and designs.		Free-standing and bayed enclosures in more than 140 variants for controlgear production and plant manufacturing.	
Product characteristics		Exceptionally robust and with a high IP and IK protection class, Rittal small and compact enclosures are compliant with all major international approvals and standards.		Infinite installation opportunities, simple assembly, uncompromising baying and tested quality are the distinguishing features of these enclosure systems. QR codes on all machinable components.	
From page		43, 227	73, 227	99, 227	



	Console systems	PC enclosure systems	Industrial Workstations	Operating housings	Support arm systems	Stand systems	Hygienic Design
	Versatility through modularity – essential for meeting individual customer requirements for machine and plant operation perfectly and cost-effectively.			Always exactly the right position: Different viewing angles of the machine, tall or short operating staff – your ergonomic solution at the human/machine interface can be found here.		Hygienic Design (HD) enclosures are key elements in the design of open processes for the food industry and clean rooms, due to their ease of cleaning.	
	–	–	–	–	–	–	–
	–	–	–	■	–	–	–
	■	■	■	■	■	■	–
	■	■	–	■	■	–	■
	Choose from console systems in over 30 combination variants, 8 PC enclosure systems and 13 variants of Industrial Workstations.			With over 30 operating housings, 5 support arm systems with a wide range of combination options and 8 stand systems, there is a solution for every requirement.		18 different enclosure types and sizes.	
	Robust and modular, especially designed for tough industrial environments where a high protection category and good accessibility are key.			Flexibility, stability, simple assembly and tremendous versatility with product combinations mean that every requirement is catered for.		The range is based on common European standards, directives and regulations in the food and luxury goods industry.	
	149, 227			169, 227		217	

Rittal – The System.

Faster – better – everywhere.



Small enclosures

Polycarbonate enclosures PK

Without knockout	44
With knockout	46
Accessories	47

Cast aluminium enclosures GA

Cast aluminium enclosures GA	48
Accessories	49



Small enclosures KX

Product comparison	50
Product overview	52

Terminal boxes KX

Product advantages	54
Without gland plate	56
With gland plate	59

E-Box KX

Product advantages	62
Depth 80 mm	64
Depth 120 mm	66
Depth 155 mm	67

Bus enclosures KX

Product advantages	68
Bus enclosures KX	70

Polycarbonate enclosures PK



PK accessories Page 47 System accessories Page 877 Cable gland, polyamide Page 1056

Applications:

- Ambient temperature range: -35 °C...+80 °C
- The specified temperatures may be limited by the installed equipment

Material:

- Enclosure: Fibreglass-reinforced polycarbonate
- Cover grey: Fibreglass-reinforced polycarbonate, all-round foamed-in PU seal
- Cover transparent: Polycarbonate, all-round foamed-in PU seal
- Cover screws: Polyamide
- Insulating bungs: Polyethylene

Colour:

- RAL 7035

Protection category IP to IEC 60 529:

- IP 66

Protection category NEMA:

- NEMA 4X

Supply includes:

- Enclosure with cover
- Cover screws
- Insulating bungs for wall mounting screws

Approvals:

- UL
- cUL
- DNV-GL

without knockouts

Width mm		65	94	94	94	110	110	Page
Height mm		65	65	94	94	110	110	
Depth mm		57	57	57	81	66	90	
Model No.		9500.000	9502.000	9504.000	9505.000	9506.000	9507.000	
	Packs of	12 pc(s).	8 pc(s).	6 pc(s).	6 pc(s).	6 pc(s).	6 pc(s).	
Cover	grey	■	■	■	■	■	■	
Accessories								
Mounting plate		-	-	-	-	-	-	
Hinge		-	-	-	-	-	-	
Wall mounting bracket	40 pc(s).	9583.000	9583.000	9583.000	9583.000	9583.000	9583.000	47

without knockouts

Width mm		130	130	130	130	180	180	Page
Height mm		94	94	130	130	94	94	
Depth mm		57	81	75	99	57	81	
Model No.		9508.000	9509.000	9510.000	9511.000	9512.000	9513.000	
	Packs of	4 pc(s).	4 pc(s).	4 pc(s).	4 pc(s).	2 pc(s).	2 pc(s).	
Cover	grey	■	■	■	■	■	■	
Accessories								
Mounting plate		-	-	-	-	-	-	
Hinge		-	-	-	-	-	-	
Wall mounting bracket	40 pc(s).	9583.000	9583.000	9583.000	9583.000	9583.000	9583.000	47

Polycarbonate enclosures PK

without knockouts

Width mm	Packs of	180	180	180	180	180	180	Page
Height mm		110	110	110	110	110	110	
Depth mm		90	90	111	111	165	165	
Model No.	2 pc(s).	9514.000	9514.100	9515.000	9515.100	9516.000	9516.100	
Cover	grey	■	-	■	-	■	-	
	transparent	-	■	-	■	-	■	

Accessories

Mounting plate		-	-	-	-	-	-	
Hinge	20 pc(s).	9581.000	9581.000	9581.000	9581.000	9581.000	9581.000	47
Wall mounting bracket	40 pc(s).	9583.000	9583.000	9583.000	9583.000	9583.000	9583.000	47

without knockouts

Width mm	Packs of	182	182	182	182	182	182	Page
Height mm		180	180	180	180	180	180	
Depth mm		90	90	111	111	165	165	
Model No.	1 pc(s).	9517.000	9517.100	9518.000	9518.100	9519.000	9519.100	
Cover	grey	■	-	■	-	■	-	
	transparent	-	■	-	■	-	■	

Accessories

Mounting plate	10 pc(s).	9548.000	9548.000	9548.000	9548.000	9548.000	9548.000	47
Hinge	20 pc(s).	9581.000	9581.000	9581.000	9581.000	9581.000	9581.000	47
Wall mounting bracket	40 pc(s).	9583.000	9583.000	9583.000	9583.000	9583.000	9583.000	47

without knockouts

Width mm	Packs of	254	254	254	254	254	254	Page
Height mm		180	180	180	180	180	180	
Depth mm		90	90	111	111	165	165	
Model No.	1 pc(s).	9520.000	9520.100	9521.000	9521.100	9522.000	9522.100	
Cover	grey	■	-	■	-	■	-	
	transparent	-	■	-	■	-	■	

Accessories

Mounting plate	8 pc(s).	9549.000	9549.000	9549.000	9549.000	9549.000	9549.000	47
Hinge	20 pc(s).	9581.000	9581.000	9581.000	9581.000	9581.000	9581.000	47
Wall mounting bracket	40 pc(s).	9583.000	9583.000	9583.000	9583.000	9583.000	9583.000	47

without knockouts

Width mm	Packs of	360	360	360	360	360	Page
Height mm		254	254	254	254	254	
Depth mm		111	111	165	165	165	
Model No.	1 pc(s).	9523.000	9523.100	9524.000	9524.100	9524.100	
Cover	grey	■	-	■	-	■	
	transparent	-	■	-	■	-	■

Accessories

Mounting plate	4 pc(s).	9550.000	9550.000	9550.000	9550.000	9550.000	47
Hinge	20 pc(s).	9581.000	9581.000	9581.000	9581.000	9581.000	47
Wall mounting bracket	40 pc(s).	9583.000	9583.000	9583.000	9583.000	9583.000	47

Polycarbonate enclosures PK



PK accessories Page 47 System accessories Page 877 Cable gland, polyamide Page 1056

Applications:

- Ambient temperature range: -35 °C...+80 °C
- The specified temperatures may be limited by the installed equipment

Material:

- Enclosure: Fibreglass-reinforced polycarbonate
- Cover: Fibreglass-reinforced polycarbonate, all-round foamed-in PU seal
- Cover screws: Polyamide
- Insulating bungs: Polyethylene

Colour:

- RAL 7035

Protection category IP to IEC 60 529:

- IP 66

Protection category NEMA:

- NEMA 4X

Supply includes:

- Enclosure with cover
- Cover screws
- Insulating bungs for wall mounting screws

Approvals:

- UL
- cUL
- DNV-GL

with knockouts

Width mm		130	180	254	Page
Height mm		94	110	180	
Depth mm		57	90	111	
Model No.		9508.050	9514.050	9521.050	
	Packs of	4 pc(s).	2 pc(s).	1 pc(s).	
Cover	grey	■	■	■	
No. of metric knockouts		10 x M16/M20	16 x M20 2 x M20/M25 2 x M32/M40	24 x M20 4 x M25/M32 4 x M32/M40	
Accessories					
Mounting plate	8 pc(s).	-	-	9549.000	47
Wall mounting bracket	40 pc(s).	9583.000	9583.000	9583.000	47

Polycarbonate enclosures PK

Accessories

Mounting plate

for PK

For individual interior installation.

Material:

- 2.5 mm melamine phenol-coated laminated paper

Colour:

- RAL 7035

Supply includes:

- Mounting plate
- Self-tapping assembly screws

Mounting plate width mm	Mounting plate height mm	For enclosure width mm	For enclosure height mm	Packs of	Model No.
150	150	182	180	10 pc(s).	9548.000
220	150	254	180	8 pc(s).	9549.000
331	220	360	254	4 pc(s).	9550.000

Hinge

for PK

For hinged attachment of covers. The supplied drilling template ensures problem-free assembly.

Material:

- Polystyrene

Colour:

- Similar to RAL 7035

Supply includes:

- 20 hinges
- Assembly parts

For enclosure width mm	For enclosure height mm	Material	Packs of	Model No.
≥ 180	≥ 110	Polystyrene	20 pc(s).	9581.000

Wall mounting bracket

for PK

The enclosure can be screwed to the wall using four wall mounting brackets. The bracket is securely attached to the enclosure by means of pins.

Applications:

- For all PK enclosures

Material:

- Polyamide, grey

Colour:

- Similar to RAL 7035

Packs of	Model No.
40 pc(s).	9583.000



Cast aluminium enclosures GA



GA accessories Page 49 System accessories Page 877

Material:

- Enclosure: Cast aluminium
- Cover: Cast aluminium, all-round CR cellular rubber cord seal

Surface finish:

- Textured paint

Colour:

- RAL 7001

Protection category IP to IEC 60 529:

- IP 66

Protection category NEMA:

- NEMA 4

Supply includes:

- Enclosure with cover
- Cover screws, captive
- Screws for attaching support rails
- Screw for connection of the PE conductor

Width mm		58	98	75	125	175	250	122	220	Page
Height mm		64	64	80	80	80	80	120	120	
Depth mm		36	36	58	58	58	58	82	93	
Model No.		9101.210	9102.210	9104.210	9105.210	9106.210	9107.210	9108.210	9110.210	
	Packs of	5 pc(s).	3 pc(s).	1 pc(s).	1 pc(s).	1 pc(s).	1 pc(s).	1 pc(s).	1 pc(s).	

Accessories

Mounting plate		-	-	-	9105.700	-	-	9108.700	9110.700	49
	Packs of	-	-	-	10 pc(s).	-	-	2 pc(s).	2 pc(s).	-
Wall mounting bracket	2 pc(s).	-	-	-	-	-	-	9121.122	9121.122	49
Support rail		see page	see page	see page	see page	see page	see page	see page	see page	997
Hinge, exterior	2 pc(s).	-	-	-	-	-	-	9123.000	9123.000	49
Earth straps		see page	see page	see page	see page	see page	see page	see page	see page	1033
Cable gland, brass		see page	see page	see page	see page	see page	see page	see page	see page	1056
Cable gland, polyamide		see page	see page	see page	see page	see page	see page	see page	see page	1056

Width mm	Packs of	360	160	260	360	202	280	330	330	Page
Height mm		120	160	160	160	232	232	230	230	
Depth mm		84	93	93	93	113	113	113	183	
Model No.	1 pc(s).	9111.210	9112.210	9113.210	9114.210	9116.210	9117.210	9118.210	9119.210	

Accessories

Mounting plate		-	9112.700	9113.700	-	9116.700	9117.700	9118.700	9118.700	49
	Packs of	-	2 pc(s).	2 pc(s).	-	1 pc(s).	1 pc(s).	1 pc(s).	1 pc(s).	-
Wall mounting bracket	2 pc(s).	9121.122	9121.160	9121.160	9121.160	9121.230	9121.230	9121.230	9121.230	49
Support rail		see page	see page	see page	see page	see page	see page	see page	see page	997
Hinge, exterior	2 pc(s).	9123.000	9123.000	9123.000	9123.000	9123.000	9123.000	9123.000	9123.000	49
Earth straps		see page	see page	see page	see page	see page	see page	see page	see page	1033
Cable gland, brass		see page	see page	see page	see page	see page	see page	see page	see page	1056
Cable gland, polyamide		see page	see page	see page	see page	see page	see page	see page	see page	1056

Cast aluminium enclosures GA

Accessories

Mounting plate

for GA

For universal interior installation, with mounting holes.

Material:

- Sheet steel

Surface finish:

- Zinc-plated

Mounting plate width mm	Mounting plate height mm	For enclosure width mm	For enclosure height mm	Packs of	Model No.
114	69	125	80	10 pc(s).	9105.700
109	107	122	120	2 pc(s).	9108.700
207	107	220	120	2 pc(s).	9110.700
145	142	160	160	2 pc(s).	9112.700
245	142	260	160	2 pc(s).	9113.700
183	214	202	232	1 pc(s).	9116.700
264	214	280	232	1 pc(s).	9117.700
314	214	330	230	1 pc(s).	9118.700

Wall mounting bracket

for GA

For external mounting on surfaces – no need to remove the cover if pre-assembled.

Material:

- Sheet steel

Surface finish:

- Zinc-plated

For enclosure height mm	Packs of	Model No.
120	2 pc(s).	9121.122
160	2 pc(s).	9121.160
≥ 230	2 pc(s).	9121.230

Hinge, exterior

for GA

For attaching the cover to the enclosure base.

Material:

- Die-cast aluminium

Colour:

- RAL 7001

Supply includes:

- 2 hinges
- 8 screws



Small enclosures KX – Product comparison



Terminal boxes KX, sheet steel	Terminal boxes KX, stainless steel	E-Box KX, sheet steel	
All enclosure panels may be taken directly from the packaging, without dismantling, and machined			
The support rails may optionally be fitted on the integral perforated mounting strip or, to maximise the enclosure depth, directly onto the rear wall of the enclosure		The mounting plate is simply attached from the front and secured to the integral perforated mounting strip in a space-saving solution	
The wall mounting brackets are easily secured from the outside with a self-tapping screw	There is no opening to the wall mounting for hygiene reasons, but the position is prepunched and can be drilled without having to measure and mark out	The wall mounting brackets are easily secured from the outside with a self-tapping screw	
A QR code on the enclosure, door or cover and mounting plate allows seamless monitoring, from receipt of the incoming goods through to delivery of the finished product			
Earthing points accessible from the front facilitate fast, secure mounting of the earth straps			
The mini cam lock may be fitted without using tools, and ensures that the cover is securely seated and centred when latching		The 180° hinges are already prefitted on the door and ready to use, the cam locks may be attached without the use of tools, and the door is easily fitted	
The three-phase surface treatment provides optimum protection against corrosion and is resistant to mineral oils, lubricants, machining emulsions and many solvents	Stainless steel 1.4301 (AISI 304) complies with maximum hygiene and corrosion protection requirements	The three-phase surface treatment provides optimum protection against corrosion and is resistant to mineral oils, lubricants, machining emulsions and many solvents	
from page 56	from page 230	from page 64	

Small enclosures KX – Product comparison



E-Box KX, stainless steel	Bus enclosures KX, sheet steel	Bus enclosures KX, stainless steel
All enclosure panels may be taken directly from the packaging, without dismantling, and machined		
The mounting plate is simply attached from the front and secured to the integral perforated mounting strip in a space-saving solution	The support rails may optionally be fitted on the integral perforated mounting strip or, to maximise the enclosure depth, directly onto the rear wall of the enclosure	
There is no opening to the wall mounting for hygiene reasons, but the position is prepunched and can be drilled without having to measure and mark out	The wall mounting brackets are easily secured from the outside with a self-tapping screw	There is no opening to the wall mounting for hygiene reasons, but the position is prepunched and can be drilled without having to measure and mark out
A QR code on the enclosure, door or cover and mounting plate allows seamless monitoring, from receipt of the incoming goods through to delivery of the finished product		
Earthing points accessible from the front facilitate fast, secure mounting of the earth straps		
The 180° hinges are prefitted on the door/cover and ready to use, the cam locks may be attached without the use of tools, and the door/cover is easily fitted		
Stainless steel 1.4301 (AISI 304) and stainless steel 1.4404 (AISI 316L), meets maximum hygiene and corrosion protection requirements	The three-phase surface treatment provides optimum protection against corrosion and is resistant to mineral oils, lubricants, machining emulsions and many solvents	Stainless steel 1.4301 (AISI 304) meets maximum hygiene and corrosion protection requirements
from page 232	from page 70	from page 234

Small enclosures KX – Product overview



		Terminal boxes KX			
Width mm	Height x depth mm	Model No.		Model No.	
		Sheet steel	Sheet steel	Stainless steel	
	Material	Without gland plate	With gland plate	Without gland plate	
150	150 x 80	1514.000	-	1560.000	
200		1528.000	-	-	
300		1515.000	-	1561.000	
150	150 x 120	1500.000	-	1564.000	
200		1529.000	-	-	
300		1501.000	1530.000	-	
400		1589.000	-	-	
200	200 x 80	1516.000	-	1562.000	
300		1517.000	-	1563.000	
400		1518.000	-	-	
200	200 x 120	1502.000	-	1565.000	
300		1503.000	1531.000	1566.000	
400		1504.000	1532.000	1568.000	
500		1505.000	1533.000	-	
600		1506.000	-	-	
800		1527.000	-	-	
400	200 x 155	-	-	-	
150	300 x 80	-	-	-	
200		-	-	-	
300		-	-	-	
150	300 x 120	-	-	-	
200		-	-	-	
300		1507.000	1535.000	1567.000	
400		1508.000	1536.000	1569.000	
500		1509.000	1537.000	-	
600		1510.000	1538.000	-	
200	300 x 155	-	-	-	
300		-	-	-	
380		-	-	-	
400		-	-	-	
600		-	-	-	
800		-	-	-	
200	400 x 80	-	-	-	
200	400 x 120	-	-	-	
300		-	-	-	
400		1511.000	1539.000	-	
600		1512.000	1540.000	-	
800	1513.000	1541.000	-		
300	400 x 155	-	-	-	
200	500 x 120	-	-	-	
300	600 x 155	-	-	-	
300	800 x 155	-	-	-	
from page		56	59	230	

Small enclosures KX – Product overview



		E-Box KX			Bus enclosures KX		
Width mm	Model No.	Sheet steel	Stainless steel 1.4301 (AISI 304)	Stainless steel 1.4404 (AISI 316L)	Sheet steel	Stainless steel	
		-	-	-	-	-	
150	1551.000	-	-	-	-	-	
200	-	-	-	-	-	-	
300	-	-	-	-	-	-	
150	1553.000	-	-	-	-	-	
200	-	-	-	-	-	-	
300	-	-	-	-	-	-	
400	-	-	-	-	-	-	
200	1546.000	-	-	-	-	-	
300	-	-	-	-	-	-	
400	-	-	-	-	-	-	
200	1549.000	-	-	-	-	-	
300	-	-	-	-	-	-	
400	-	-	-	-	-	1585.000	
500	-	-	-	-	-	-	
600	-	-	-	-	-	1586.000	
800	-	-	-	-	-	-	
400	-	-	-	-	1610.000	-	
150	1545.000	-	-	-	-	-	
200	1552.000	-	-	-	-	1583.000	
150	1548.000	-	-	-	-	-	
200	1554.000	1584.000	-	-	-	-	
300	1555.000	-	-	-	-	-	
400	-	-	-	-	-	-	
500	-	-	-	-	-	-	
600	-	-	-	-	-	-	
200	1574.000	1587.000	1301.000	-	-	-	
300	1575.000	-	-	-	-	-	
380	1576.000	1588.000	-	-	-	-	
400	-	-	-	1611.000	-	-	
600	-	-	-	1612.000	-	-	
800	-	-	-	1613.000	-	-	
200	1547.000	-	-	-	-	-	
200	1550.000	-	-	-	-	-	
300	1556.000	-	-	-	-	-	
400	-	-	-	-	-	-	
600	-	-	-	-	-	-	
800	-	-	-	-	-	-	
300	1577.000	-	-	-	-	-	
200	1557.000	-	-	-	-	-	
300	1578.000	-	-	-	-	-	
300	1579.000	-	-	-	-	-	
		64	232	232	70	234	

Terminal boxes KX – Added precision



Precision

- The mini cam lock is very simple to operate. A quarter of a turn is sufficient to correctly centre the cover while locking; this ensures all-round air-tight positioning.



Ease of assembly

- The standard eyelet in the rear panel allows rapid screw-fastening of the wall mounting bracket from the outside with a self-tapping screw; no need for a lock nut on the inside. The high protection category is retained in full.



Space utilisation

- The support rails may optionally be fitted on the front of the integral perforated mounting strip or, to maximise the enclosure depth, directly onto the rear wall of the enclosure.



Potential equalisation

- Installation of the gland plate includes automatic potential equalisation. Contact is made by two self-tapping screws guided through special holes.

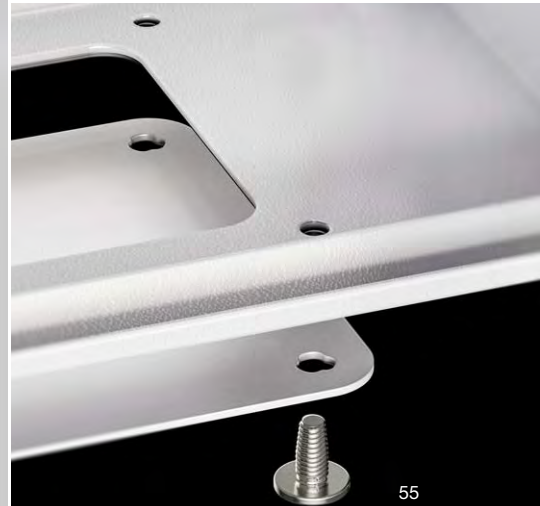

Small enclosures KX



System accessories Page 877 Terminal boxes KX, stainless steel Page 230 Ex enclosures Page 257 Hygienic Design Page 217

Material:

- Enclosure: Sheet steel
- Cover: Sheet steel, all-round foamed-in PU seal

Surface finish:

- Enclosure and cover: Dipcoat primed, powder-coated on the outside, textured paint

Colour:

- RAL 7035

Protection category IP to IEC 60 529:

- IP 66

NEMA protection category:

- NEMA 4

Supply includes:

- Enclosure with cover
- Mini cam locks

Approvals:

- UL
 - cUL
- Further approvals can be found on the Internet.

Terminal boxes KX, sheet steel, without gland plate

Width mm	Packs of	150	200	200	300	300	400	Page
Height mm		150	150	200	150	200	200	
Depth mm		80	80	80	80	80	80	
Material thickness of enclosure mm		1.25	1.25	1.25	1.25	1.25	1.25	
Material thickness of cover mm		1.25	1.25	1.25	1.25	1.25	1.25	
Model No.	1 pc(s).	1514.000	1528.000	1516.000	1515.000	1517.000	1518.000	
Weight kg		1.40	1.45	1.80	1.90	2.39	3.01	
Mini cam lock		4	4	4	4	4	4	

Accessories

Wall mounting bracket, for AX sheet steel, KX sheet steel	4 pc(s).	1590.010	1590.010	1590.010	1590.010	1590.010	1590.010	965
Pole clamp	2 pc(s).	2584.100	2584.100	2584.100	2584.100	2584.100	2584.100	968
Mounting plates	1 pc(s).	1560.800	1575.800	1562.800	1561.800	1563.800	1564.800	970
Support rails TS 35/7.5	10 pc(s).	2314.000	2315.000	2315.000	2316.000	2316.000	2317.000	997
Support rails TS 35/15		–	–	–	–	–	–	
Mounting clip for support rails	30 pc(s).	2309.000	2309.000	2309.000	2309.000	2309.000	2309.000	997
Mounting bracket	4 pc(s).	4597.000	4597.000	4597.000	4597.000	4597.000	4597.000	999
Rail mounting bracket	20 pc(s).	2365.000	2365.000	2365.000	2365.000	2365.000	2365.000	1002
Mounting claw for second mounting level	20 pc(s).	2309.100	2309.100	2309.100	2309.100	2309.100	2309.100	998
Cover hinge	6 pc(s).	1592.200	1592.200	1592.200	1592.200	1592.200	1592.200	951
Earth straps	5 pc(s).	2565.100	2565.100	2565.100	2565.100	2565.100	2565.100	1033
Baying kit		–	–	–	–	–	–	
Pressure relief stopper	5 pc(s).	2459.500	2459.500	2459.500	2459.500	2459.500	2459.500	900
Condensate discharge	6 pc(s).	2459.000	2459.000	2459.000	2459.000	2459.000	2459.000	900
Self-tapping screws	300 pc(s).	2487.000	2487.000	2487.000	2487.000	2487.000	2487.000	1004
Connector gland, small	5 pc(s).	2400.500	2400.500	2400.500	2400.500	2400.500	2400.500	1047

Terminal boxes KX, sheet steel, without gland plate

Width mm	Packs of	150	200	200	300	300	Page
Height mm		150	150	200	150	200	
Depth mm		120	120	120	120	120	
Material thickness of enclosure mm		1.25	1.25	1.25	1.25	1.25	
Material thickness of cover mm		1.25	1.25	1.25	1.25	1.25	
Model No.	1 pc(s).	1500.000	1529.000	1502.000	1501.000	1503.000	
Weight kg		1.46	1.75	2.13	2.32	2.69	
Mini cam lock		4	4	4	4	4	

Accessories

Wall mounting bracket, for AX sheet steel, KX sheet steel	4 pc(s).	1590.010	1590.010	1590.010	1590.010	1590.010	965
Pole clamp	2 pc(s).	2584.100	2584.100	2584.100	2584.100	2584.100	968
Mounting plates	1 pc(s).	1560.800	1575.800	1562.800	1561.800	1563.800	970
Support rails TS 35/7.5	10 pc(s).	2314.000	2315.000	2315.000	2316.000	2316.000	997
Support rails TS 35/15		-	-	-	-	-	
Mounting clip for support rails	30 pc(s).	2309.000	2309.000	2309.000	2309.000	2309.000	997
Mounting bracket	4 pc(s).	4597.000	4597.000	4597.000	4597.000	4597.000	999
Rail mounting bracket	20 pc(s).	2366.000	2366.000	2366.000	2366.000	2366.000	1002
Mounting claw for second mounting level	20 pc(s).	2309.100	2309.100	2309.100	2309.100	2309.100	998
Cover hinge	6 pc(s).	1592.200	1592.200	1592.200	1592.200	1592.200	951
Earth straps	5 pc(s).	2565.050	2565.050	2565.050	2565.050	2565.050	1033
Baying kit	1 pc(s).	1199.100	1199.100	1199.100	1199.100	1199.100	916
Pressure relief stopper	5 pc(s).	2459.500	2459.500	2459.500	2459.500	2459.500	900
Condensate discharge	6 pc(s).	2459.000	2459.000	2459.000	2459.000	2459.000	900
Self-tapping screws	300 pc(s).	2487.000	2487.000	2487.000	2487.000	2487.000	1004
Connector gland, small	5 pc(s).	2400.500	2400.500	2400.500	2400.500	2400.500	1047

Terminal boxes KX, sheet steel, without gland plate

Width mm	Packs of	300	400	400	400	400	500	Page
Height mm		300	150	200	300	400	200	
Depth mm		120	120	120	120	120	120	
Material thickness of enclosure mm		1.25	1.25	1.25	1.25	1.25	1.25	
Material thickness of cover mm		1.25	1.25	1.25	1.25	1.25	1.25	
Model No.	1 pc(s).	1507.000	1589.000	1504.000	1508.000	1511.000	1505.000	
Weight kg		3.78	2.98	3.42	4.70	5.67	4.18	
Mini cam lock		4	4	4	4	4	4	

Accessories

Wall mounting bracket, for AX sheet steel, KX sheet steel	4 pc(s).	1590.010	1590.010	1590.010	1590.010	1590.010	1590.010	965
Pole clamp	2 pc(s).	2584.100	2584.100	2584.100	2584.100	2584.100	2584.100	968
Mounting plates	1 pc(s).	1567.800	1576.800	1564.800	1568.800	1571.800	1565.800	970
Support rails TS 35/7.5	10 pc(s).	2316.000	2317.000	2317.000	2317.000	2317.000	-	997
Support rails TS 35/15	10 pc(s).	-	-	-	-	-	2318.000	997
Mounting clip for support rails	30 pc(s).	2309.000	2309.000	2309.000	2309.000	2309.000	2309.000	997
Mounting bracket	4 pc(s).	4597.000	4597.000	4597.000	4597.000	4597.000	4597.000	999
Rail mounting bracket	20 pc(s).	2366.000	2366.000	2366.000	2366.000	2366.000	2366.000	1002
Mounting claw for second mounting level	20 pc(s).	2309.100	2309.100	2309.100	2309.100	2309.100	2309.100	998
Cover hinge	6 pc(s).	1592.200	1592.200	1592.200	1592.200	1592.200	1592.200	951
Earth straps	5 pc(s).	2565.050	2565.050	2565.050	2565.050	2565.050	2565.050	1033
Baying kit	1 pc(s).	1199.100	1199.100	1199.100	1199.100	1199.100	1199.100	916
Pressure relief stopper	5 pc(s).	2459.500	2459.500	2459.500	2459.500	2459.500	2459.500	900
Condensate discharge	6 pc(s).	2459.000	2459.000	2459.000	2459.000	2459.000	2459.000	900
Self-tapping screws	300 pc(s).	2487.000	2487.000	2487.000	2487.000	2487.000	2487.000	1004
Connector gland, small	5 pc(s).	2400.500	2400.500	2400.500	2400.500	2400.500	2400.500	1047

Small enclosures KX

Terminal boxes KX, sheet steel, without gland plate

Width mm	Packs of	500	600	600	600	800	800	Page
Height mm		300	200	300	400	200	400	
Depth mm		120	120	120	120	120	120	
Material thickness of enclosure mm		1.25	1.25	1.25	1.25	1.25	1.25	
Material thickness of cover mm		1.25	1.25	1.25	1.25	1.25	1.25	
Model No.	1 pc(s).	1509.000	1506.000	1510.000	1512.000	1527.000	1513.000	
Weight kg		5.57	4.92	6.28	8.35	6.45	11.00	
Mini cam lock		4	6	6	6	6	6	
Accessories								
Wall mounting bracket, for AX sheet steel, KX sheet steel	4 pc(s).	1590.010	1590.010	1590.010	1590.010	1590.010	1590.010	965
Pole clamp	2 pc(s).	2584.100	2584.100	2584.100	2584.100	2584.100	2584.100	968
Mounting plates	1 pc(s).	1569.800	1566.800	1570.800	1572.800	1574.800	1573.800	970
Support rails TS 35/7.5		-	-	-	-	-	-	
Support rails TS 35/15	10 pc(s).	2318.000	2319.000	2319.000	2319.000	-	-	997
Mounting clip for support rails	30 pc(s).	2309.000	2309.000	2309.000	2309.000	2309.000	2309.000	997
Mounting bracket	4 pc(s).	4597.000	4597.000	4597.000	4597.000	4597.000	4597.000	999
Rail mounting bracket	20 pc(s).	2366.000	2366.000	2366.000	2366.000	2366.000	2366.000	1002
Mounting claw for second mounting level	20 pc(s).	2309.100	2309.100	2309.100	2309.100	2309.100	2309.100	998
Cover hinge	6 pc(s).	1592.200	1592.200	1592.200	1592.200	1592.200	1592.200	951
Earth straps	5 pc(s).	2565.050	2565.050	2565.050	2565.050	2565.050	2565.050	1033
Baying kit	1 pc(s).	1199.100	1199.100	1199.100	1199.100	1199.100	1199.100	916
Pressure relief stopper	5 pc(s).	2459.500	2459.500	2459.500	2459.500	2459.500	2459.500	900
Condensate discharge	6 pc(s).	2459.000	2459.000	2459.000	2459.000	2459.000	2459.000	900
Self-tapping screws	300 pc(s).	2487.000	2487.000	2487.000	2487.000	2487.000	2487.000	1004
Connector gland, small	5 pc(s).	2400.500	2400.500	2400.500	2400.500	2400.500	2400.500	1047

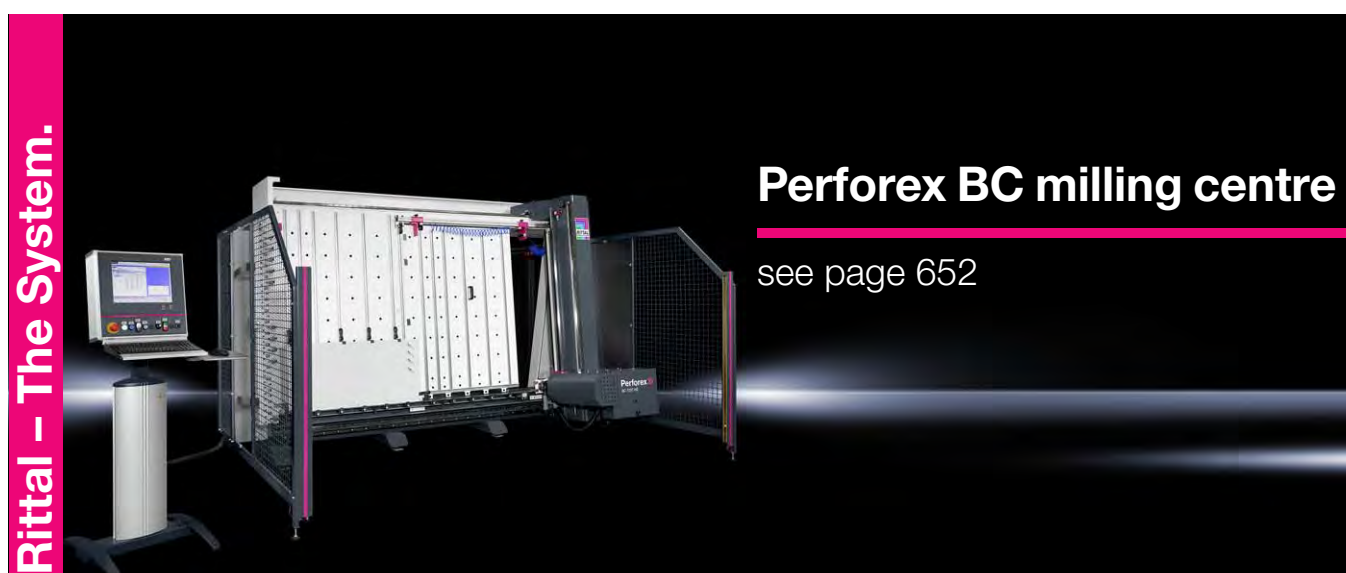



System accessories Page 877 **Terminal boxes KX, stainless steel** Page 230 **Ex enclosures** Page 257 **Hygienic Design** Page 217

Material:

- Enclosure: Sheet steel
- Cover: Sheet steel, all-round foamed-in PU seal

Surface finish:

- Enclosure and cover: Dipcoat primed, powder-coated on the outside, textured paint

Colour:

- RAL 7035

Protection category IP to IEC 60 529:

- IP 55

NEMA protection category:

- NEMA 12

Supply includes:

- Enclosure with cover
- Mini cam locks
- Sheet steel gland plates with seals and assembly parts

Approvals:

- UL
 - cUL
- Further approvals can be found on the Internet.

Terminal boxes KX, sheet steel, with gland plate

Width mm	Packs of	300	300	300	400	400	400	500	Page
Height mm		150	200	300	200	300	400	200	
Depth mm		120	120	120	120	120	120	120	
Material thickness of enclosure mm		1.25	1.25	1.25	1.25	1.25	1.25	1.25	
Material thickness of cover mm		1.25	1.25	1.25	1.25	1.25	1.25	1.25	
Model No.	1 pc(s).	1530.000	1531.000	1535.000	1532.000	1536.000	1539.000	1533.000	
Weight kg		2.62	3.12	4.47	3.82	5.40	6.61	4.73	
Mini cam lock		4	4	4	4	4	4	4	
Gland plate (top + bottom), quantity		1 + 1	1 + 1	1 + 1	1 + 1	1 + 1	1 + 1	2 + 2	
Gland plate (left + right), quantity		-	-	1 + 1	-	1 + 1	1 + 1	-	
Accessories									
Wall mounting bracket, for AX sheet steel, KX sheet steel	4 pc(s).	1590.010	1590.010	1590.010	1590.010	1590.010	1590.010	1590.010	965
Pole clamp	2 pc(s).	2584.100	2584.100	2584.100	2584.100	2584.100	2584.100	2584.100	968
Mounting plates	1 pc(s).	1561.800	1563.800	1567.800	1564.800	1568.800	1571.800	1565.800	970
Support rails TS 35/7.5	10 pc(s).	2316.000	2316.000	2316.000	2317.000	2317.000	2317.000	-	997
Support rails TS 35/15		-	-	-	-	-	-	-	
Mounting clip for support rails	30 pc(s).	2309.000	2309.000	2309.000	2309.000	2309.000	2309.000	2309.000	997
Mounting bracket	4 pc(s).	4597.000	4597.000	4597.000	4597.000	4597.000	4597.000	4597.000	999
Rail mounting bracket	20 pc(s).	2366.000	2366.000	2366.000	2366.000	2366.000	2366.000	2366.000	1002
Mounting claw for second mounting level	20 pc(s).	2309.100	2309.100	2309.100	2309.100	2309.100	2309.100	2309.100	998
Cover hinge	6 pc(s).	1592.200	1592.200	1592.200	1592.200	1592.200	1592.200	1592.200	951
Metal gland plates	1 pc(s).	1581.200	1581.200	1581.200	1581.200	1581.200	1581.200	1581.200	1054
Earth straps	5 pc(s).	2565.050	2565.050	2565.050	2565.050	2565.050	2565.050	2565.050	1033
Baying kit	1 pc(s).	1199.100	1199.100	1199.100	1199.100	1199.100	1199.100	1199.100	916
Pressure relief stopper	5 pc(s).	2459.500	2459.500	2459.500	2459.500	2459.500	2459.500	2459.500	900
Condensate discharge	6 pc(s).	2459.000	2459.000	2459.000	2459.000	2459.000	2459.000	2459.000	900
Self-tapping screws	300 pc(s).	2487.000	2487.000	2487.000	2487.000	2487.000	2487.000	2487.000	1004
Connector gland, small	5 pc(s).	2400.500	2400.500	2400.500	2400.500	2400.500	2400.500	2400.500	1047

Small enclosures KX

Terminal boxes KX, sheet steel, with gland plate

Width mm	Packs of	500	600	600	800	Page
Height mm		300	300	400	400	
Depth mm		120	120	120	120	
Material thickness of enclosure mm		1.25	1.25	1.25	1.25	
Material thickness of cover mm		1.25	1.25	1.25	1.25	
Model No.	1 pc(s).	1537.000	1538.000	1540.000	1541.000	
Weight kg		6.01	7.02	9.32	11.10	
Mini cam lock		4	6	6	6	
Gland plate (top + bottom), quantity		2 + 2	2 + 2	2 + 2	3 + 3	
Gland plate (left + right), quantity		1 + 1	1 + 1	1 + 1	1 + 1	
Accessories						
Wall mounting bracket, for AX sheet steel, KX sheet steel	4 pc(s).	1590.010	1590.010	1590.010	1590.010	965
Pole clamp	2 pc(s).	2584.100	2584.100	2584.100	2584.100	968
Mounting plates	1 pc(s).	1569.800	1570.800	1572.800	1573.800	970
Support rails TS 35/7.5		-	-	-	-	
Support rails TS 35/15	10 pc(s).	2318.000	2319.000	2319.000	-	997
Mounting clip for support rails	30 pc(s).	2309.000	2309.000	2309.000	2309.000	997
Mounting bracket	4 pc(s).	4597.000	4597.000	4597.000	4597.000	999
Rail mounting bracket	20 pc(s).	2366.000	2366.000	2366.000	2366.000	1002
Mounting claw for second mounting level	20 pc(s).	2309.100	2309.100	2309.100	2309.100	998
Cover hinge	6 pc(s).	1592.200	1592.200	1592.200	1592.200	951
Metal gland plates	1 pc(s).	1581.200	1581.200	1581.200	1581.200	1054
Earth straps	5 pc(s).	2565.050	2565.050	2565.050	2565.050	1033
Baying kit	1 pc(s).	1199.100	1199.100	1199.100	1199.100	916
Pressure relief stopper	5 pc(s).	2459.500	2459.500	2459.500	2459.500	900
Condensate discharge	6 pc(s).	2459.000	2459.000	2459.000	2459.000	900
Self-tapping screws	300 pc(s).	2487.000	2487.000	2487.000	2487.000	1004
Connector gland, small	5 pc(s).	2400.500	2400.500	2400.500	2400.500	1047

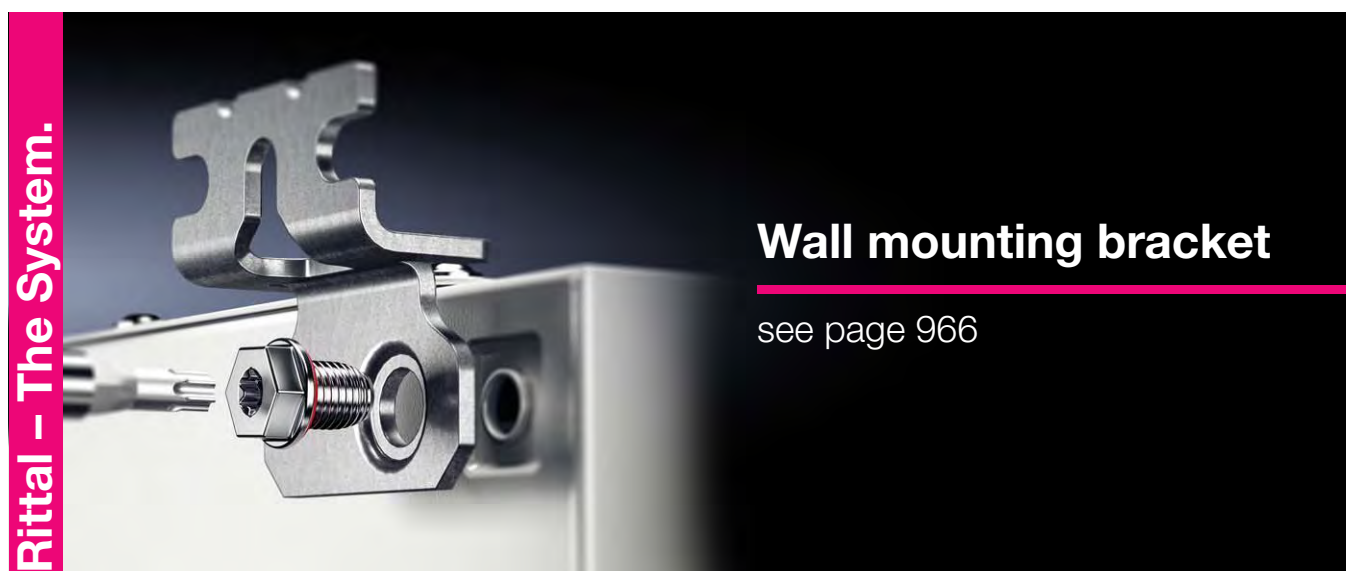

Rittal – The System.

Wall mounting bracket

see page 966

UL conformity

Guaranteed when Rittal accessory components are used



E-Box KX – Added time savings



Protection

- The deliberately slimline enclosure edge fold provides broad, secure contact with the seamless PU foam seal and helps preserve the protection category of IP 66.



Space

- The 180° door hinges create more space and improve access to the enclosure interior.



Ease of assembly

- The standard eyelet in the rear panel allows rapid screw-fastening of the wall mounting bracket from the outside with a self-tapping screw; no need for a lock nut on the inside. The high protection category is retained in full.



Speed

- The mounting plate and door may be taken straight from the packet and are ready for processing.



Small enclosures KX



System accessories Page 877 E-Box KX, stainless steel Page 232 Ex enclosures Page 257

Material:

- Enclosure: Sheet steel
- Door: Sheet steel, all-round foamed-in PU seal

Surface finish:

- Enclosure and door: Dipcoat-primed, powder-coated on the outside, textured paint
- Mounting plate: Zinc-plated

Colour:

- RAL 7035

Protection category IP to IEC 60 529:

- IP 66

Protection category NEMA:

- NEMA 4

Supply includes:

- Enclosure with door
- Mounting plate
- Cam lock with 3 mm double-bit insert

Approvals:

- UL
- cUL

Further approvals can be found on the Internet.

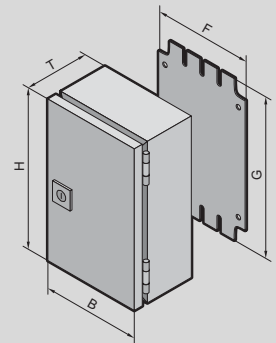

E-Box KX, sheet steel, depth 80 mm

Width (B) mm	Packs of	150	150	200	200	200	Page
Height (H) mm		150	300	200	300	400	
Depth (T) mm		80	80	80	80	80	
Mounting plate width (F) mm		125	125	175	175	175	
Mounting plate height (G) mm		135	285	185	285	385	
Material thickness – enclosure mm		1.25	1.25	1.25	1.25	1.25	
Material thickness – door mm		1.25	1.25	1.25	1.25	1.25	
Material thickness – mounting plate mm		2.0	2.0	2.0	2.0	2.0	
Model No.	1 pc(s).	1551.000	1545.000	1546.000	1552.000	1547.000	
Weight kg		1.49	2.54	2.26	3.18	4.15	
Accessories							
Wall mounting bracket, for AX sheet steel, KX sheet steel	4 pc(s).	1590.010	1590.010	1590.010	1590.010	1590.010	965
Pole clamp	2 pc(s).	2584.100	2584.100	2584.100	2584.100	2584.100	968
Support rails TS 35/7.5	10 pc(s).	2314.000	2314.000	2315.000	2315.000	2315.000	997
Mounting clip for support rails	30 pc(s).	2309.000	2309.000	2309.000	2309.000	2309.000	997
Mounting bracket	4 pc(s).	4597.000	4597.000	4597.000	4597.000	4597.000	999
Rail mounting bracket	20 pc(s).	2365.000	2365.000	2365.000	2365.000	2365.000	1002
Mini-comfort handle AX for lock inserts or profile half-cylinders	1 pc(s).	2537.100	2537.100	2537.100	2537.100	2537.100	940
Mini-comfort handle AX for padlocks and lock inserts or profile half-cylinders	1 pc(s).	2537.300	2537.300	2537.300	2537.300	2537.300	940
Lock insert 7 mm square	1 pc(s).	2460.000	2460.000	2460.000	2460.000	2460.000	941
Lock insert 8 mm square	1 pc(s).	2461.000	2461.000	2461.000	2461.000	2461.000	941
Lock insert 7 mm triangular	1 pc(s).	2462.000	2462.000	2462.000	2462.000	2462.000	941
Lock insert 8 mm triangular	1 pc(s).	2463.000	2463.000	2463.000	2463.000	2463.000	941
Lock insert, screwdriver	1 pc(s).	2464.000	2464.000	2464.000	2464.000	2464.000	941
Lock insert Daimler	1 pc(s).	2465.000	2465.000	2465.000	2465.000	2465.000	941
Lock insert 3 mm double-bit	1 pc(s).	2466.000	2466.000	2466.000	2466.000	2466.000	941
Lock insert Fiat	1 pc(s).	2307.000	2307.000	2307.000	2307.000	2307.000	941
Lock insert 6.5 mm triangular	1 pc(s).	2460.650	2460.650	2460.650	2460.650	2460.650	941
Earth straps	5 pc(s).	2565.100	2565.100	2565.100	2565.100	2565.100	1033
Pressure relief stopper	5 pc(s).	2459.500	2459.500	2459.500	2459.500	2459.500	900
Condensate discharge	6 pc(s).	2459.000	2459.000	2459.000	2459.000	2459.000	900
Self-tapping screws	300 pc(s).	2487.000	2487.000	2487.000	2487.000	2487.000	1004
Connector gland, small	5 pc(s).	2400.500	2400.500	2400.500	2400.500	2400.500	1047

Rittal – The System.



Mini-comfort handle AX

see page 940

Small enclosures KX

E-Box KX, sheet steel, depth 120 mm

Width (B) mm	Packs of	150	150	200	200	200	200	300	300	Page
Height (H) mm		150	300	200	300	400	500	300	400	
Depth (T) mm		120	120	120	120	120	120	120	120	
Mounting plate width (F) mm		125	125	175	175	175	175	275	275	
Mounting plate height (G) mm		135	285	185	285	385	485	285	385	
Material thickness – enclosure mm		1.25	1.25	1.25	1.25	1.25	1.25	1.25	1.25	
Material thickness – door mm		1.25	1.25	1.25	1.25	1.25	1.25	1.25	1.25	
Material thickness – mounting plate mm		2.0	2.0	2.0	2.0	2.0	2.0	2.0	2.0	
Model No.	1 pc(s).	1553.000	1548.000	1549.000	1554.000	1550.000	1557.000	1555.000	1556.000	
Weight kg		1.72	2.93	2.64	3.63	4.62	5.57	5.14	6.38	

Accessories										
Wall mounting bracket, for AX sheet steel, KX sheet steel	4 pc(s).	1590.010	1590.010	1590.010	1590.010	1590.010	1590.010	1590.010	1590.010	965
Pole clamp	2 pc(s).	2584.100	2584.100	2584.100	2584.100	2584.100	2584.100	2584.100	2584.100	968
Support rails TS 35/7.5	10 pc(s).	2314.000	2314.000	2315.000	2315.000	2315.000	2315.000	2316.000	2316.000	997
Mounting clip for support rails	30 pc(s).	2309.000	2309.000	2309.000	2309.000	2309.000	2309.000	2309.000	2309.000	997
Mounting bracket	4 pc(s).	4597.000	4597.000	4597.000	4597.000	4597.000	4597.000	4597.000	4597.000	999
Rail mounting bracket	20 pc(s).	2366.000	2366.000	2366.000	2366.000	2366.000	2366.000	2366.000	2366.000	1002
Mini-comfort handle AX for lock inserts or profile half-cylinders	1 pc(s).	2537.100	2537.100	2537.100	2537.100	2537.100	2537.100	2537.100	2537.100	940
Mini-comfort handle AX for padlocks and lock inserts or profile half-cylinders	1 pc(s).	2537.300	2537.300	2537.300	2537.300	2537.300	2537.300	2537.300	2537.300	940
Lock insert 7 mm square	1 pc(s).	2460.000	2460.000	2460.000	2460.000	2460.000	2460.000	2460.000	2460.000	941
Lock insert 8 mm square	1 pc(s).	2461.000	2461.000	2461.000	2461.000	2461.000	2461.000	2461.000	2461.000	941
Lock insert 7 mm triangular	1 pc(s).	2462.000	2462.000	2462.000	2462.000	2462.000	2462.000	2462.000	2462.000	941
Lock insert 8 mm triangular	1 pc(s).	2463.000	2463.000	2463.000	2463.000	2463.000	2463.000	2463.000	2463.000	941
Lock insert, screwdriver	1 pc(s).	2464.000	2464.000	2464.000	2464.000	2464.000	2464.000	2464.000	2464.000	941
Lock insert Daimler	1 pc(s).	2465.000	2465.000	2465.000	2465.000	2465.000	2465.000	2465.000	2465.000	941
Lock insert 3 mm double-bit	1 pc(s).	2466.000	2466.000	2466.000	2466.000	2466.000	2466.000	2466.000	2466.000	941
Lock insert Fiat	1 pc(s).	2307.000	2307.000	2307.000	2307.000	2307.000	2307.000	2307.000	2307.000	941
Lock insert 6.5 mm triangular	1 pc(s).	2460.650	2460.650	2460.650	2460.650	2460.650	2460.650	2460.650	2460.650	941
Earth straps	5 pc(s).	2565.050	2565.050	2565.050	2565.050	2565.050	2565.050	2565.050	2565.050	1033
Baying kit	1 pc(s).	1199.100	1199.100	1199.100	1199.100	1199.100	1199.100	1199.100	1199.100	916
Pressure relief stopper	5 pc(s).	2459.500	2459.500	2459.500	2459.500	2459.500	2459.500	2459.500	2459.500	900
Condensate discharge	6 pc(s).	2459.000	2459.000	2459.000	2459.000	2459.000	2459.000	2459.000	2459.000	900
Self-tapping screws	300 pc(s).	2487.000	2487.000	2487.000	2487.000	2487.000	2487.000	2487.000	2487.000	1004
Connector gland, small	5 pc(s).	2400.500	2400.500	2400.500	2400.500	2400.500	2400.500	2400.500	2400.500	1047

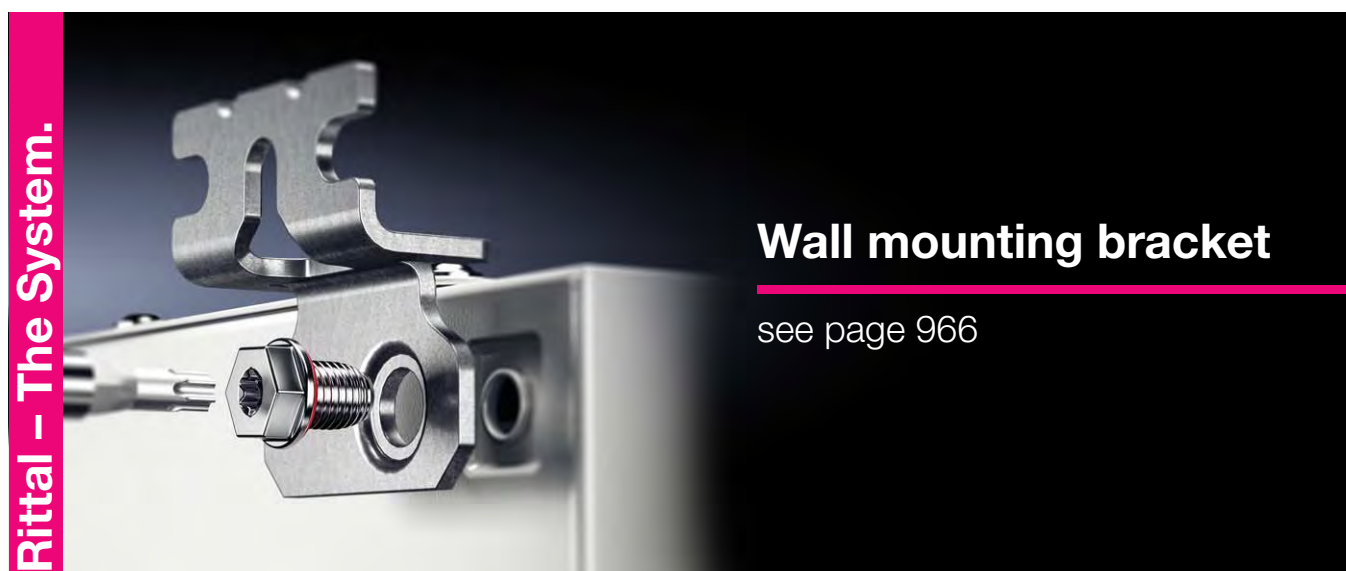

Rittal – The System.

Wall mounting bracket

see page 966

E-Box KX, sheet steel, depth 155 mm

Width (B) mm	Packs of	200	300	300	300	300	380	Page
Height (H) mm		300	300	400	600	800	300	
Depth (T) mm		155	155	155	155	155	155	
Mounting plate width (F) mm		175	275	275	275	275	365	
Mounting plate height (G) mm		285	285	385	585	785	275	
Material thickness – enclosure mm		1.25	1.25	1.25	1.25	1.25	1.25	
Material thickness – door mm		1.25	1.25	1.25	1.25	1.25	1.25	
Material thickness – mounting plate mm		2.0	2.0	2.0	2.0	2.0	2.0	
Model No.	1 pc(s).	1574.000	1575.000	1577.000	1578.000	1579.000	1576.000	
Weight kg		3.98	5.50	6.98	10.30	12.80	6.64	

Accessories								
Wall mounting bracket, for AX sheet steel, KX sheet steel	4 pc(s).	1590.010	1590.010	1590.010	1590.010	1590.010	1590.010	965
Pole clamp	2 pc(s).	2584.100	2584.100	2584.100	2584.100	2584.100	2584.100	968
Support rails TS 35/7.5	10 pc(s).	2315.000	2316.000	2316.000	2316.000	2316.000	2317.000 ¹⁾	997
Mounting clip for support rails	30 pc(s).	2309.000	2309.000	2309.000	2309.000	2309.000	2309.000	997
Mounting bracket	4 pc(s).	4597.000	4597.000	4597.000	4597.000	4597.000	4597.000	999
Rail mounting bracket	20 pc(s).	2366.000	2366.000	2366.000	2366.000	2366.000	2366.000	1002
Mini-comfort handle AX for lock inserts or profile half-cylinders	1 pc(s).	2537.100	2537.100	2537.100	2537.100	2537.100	2537.100	940
Mini-comfort handle AX for padlocks and lock inserts or profile half-cylinders	1 pc(s).	2537.300	2537.300	2537.300	2537.300	2537.300	2537.300	940
Lock insert 7 mm square	1 pc(s).	2460.000	2460.000	2460.000	2460.000	2460.000	2460.000	941
Lock insert 8 mm square	1 pc(s).	2461.000	2461.000	2461.000	2461.000	2461.000	2461.000	941
Lock insert 7 mm triangular	1 pc(s).	2462.000	2462.000	2462.000	2462.000	2462.000	2462.000	941
Lock insert 8 mm triangular	1 pc(s).	2463.000	2463.000	2463.000	2463.000	2463.000	2463.000	941
Lock insert, screwdriver	1 pc(s).	2464.000	2464.000	2464.000	2464.000	2464.000	2464.000	941
Lock insert Daimler	1 pc(s).	2465.000	2465.000	2465.000	2465.000	2465.000	2465.000	941
Lock insert 3 mm double-bit	1 pc(s).	2466.000	2466.000	2466.000	2466.000	2466.000	2466.000	941
Lock insert Fiat	1 pc(s).	2307.000	2307.000	2307.000	2307.000	2307.000	2307.000	941
Lock insert 6.5 mm triangular	1 pc(s).	2460.650	2460.650	2460.650	2460.650	2460.650	2460.650	941
Earth straps	5 pc(s).	2565.050	2565.050	2565.050	2565.050	2565.050	2565.050	1033
Baying kit	1 pc(s).	1199.100	1199.100	1199.100	1199.100	1199.100	1199.100	916
Pressure relief stopper	5 pc(s).	2459.500	2459.500	2459.500	2459.500	2459.500	2459.500	900
Condensate discharge	6 pc(s).	2459.000	2459.000	2459.000	2459.000	2459.000	2459.000	900
Self-tapping screws	300 pc(s).	2487.000	2487.000	2487.000	2487.000	2487.000	2487.000	1004
Connector gland, small	5 pc(s).	2400.500	2400.500	2400.500	2400.500	2400.500	2400.500	1047

¹⁾ Must be cut to length accordingly

Rittal – The System.



Sealing frame, modular

see page 1048

Bus enclosures KX – Added clarity



Flexibility

- Depending on requirements, the enclosures may be fitted with support rails or mounting plates.
- The support rails may optionally be fitted on the front of the integral perforated mounting strip or, to maximise the enclosure depth, directly onto the rear wall of the enclosure.

Precision

- The quick-release fastener is very simple to operate. A quarter of a turn is sufficient to correctly centre the cover while locking; this ensures all-round air-tight positioning.

Access

- The wide door opening angle of up to 180° gives you plenty of space to fit and replace modules quickly and easily. The large viewing window is convenient for continuously monitoring the components inside the enclosure.

Ease of assembly

- The standard eyelet in the rear panel allows rapid screw-fastening of the wall mounting bracket from the outside with a self-tapping screw; no need for a lock nut on the inside. The high protection category is retained in full.



Small enclosures KX



System accessories Page 877 Bus enclosures KX, stainless steel Page 234

Material:

- Enclosure: Sheet steel
- Cover: Sheet steel, all-round foamed-in PU seal
- Viewing window: Polycarbonate, 4 mm

Surface finish:

- Enclosure and cover: Dipcoat-primed, powder-coated on the outside, textured paint

Colour:

- RAL 7035

Protection category IP to IEC 60 529:

- IP 65

Protection category NEMA:

- NEMA 12

Supply includes:

- Enclosure with hinged cover
- Viewing window in cover
- Mini cam lock

Approvals:

- UL
- cUL

Further approvals can be found on the Internet.

Bus enclosures KX, sheet steel

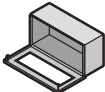
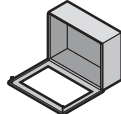
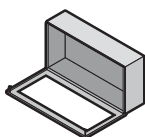
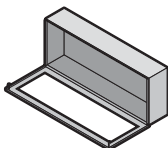
						
Width mm	Packs of	400	400	600	800	Page
Height mm		200	300	300	300	
Depth mm		155	155	155	155	
Material thickness – enclosure mm		1.25	1.25	1.25	1.25	
Material thickness – cover mm		1.25	1.25	1.25	1.25	
Model No.	1 pc(s).	1610.000	1611.000	1612.000	1613.000	
Weight kg		2.36	4.72	5.47	7.78	
Accessories						
Wall mounting bracket, for AX sheet steel, KX sheet steel	4 pc(s).	1590.010	1590.010	1590.010	1590.010	965
Pole clamp	2 pc(s).	2584.100	2584.100	2584.100	2584.100	968
Mounting plates	1 pc(s).	1564.800	1568.800	1570.800	1570.810	970
Support rails TS 35/7.5	10 pc(s).	2317.000	2317.000	2319.000	2317.000	997
Mounting clip for support rails	30 pc(s).	2309.000	2309.000	2309.000	2309.000	997
Mounting bracket	4 pc(s).	4597.000	4597.000	4597.000	4597.000	999
Rail mounting bracket	20 pc(s).	2366.000	2366.000	2366.000	2366.000	1002
Mounting claw for second mounting level	20 pc(s).	2309.100	2309.100	2309.100	2309.100	998
Pressure relief stopper	5 pc(s).	2459.500	2459.500	2459.500	2459.500	900
Condensate discharge	6 pc(s).	2459.000	2459.000	2459.000	2459.000	900
Baying kit	1 pc(s).	1199.100	1199.100	1199.100	1199.100	916
Earth straps	5 pc(s).	2565.050	2565.050	2565.050	2565.050	1033
Self-tapping screws	300 pc(s).	2487.000	2487.000	2487.000	2487.000	1004
Connector gland, small	5 pc(s).	2400.500	2400.500	2400.500	2400.500	1047

Rittal Configuration System

Plausibility-checked configuration of products and accessories, see page 272

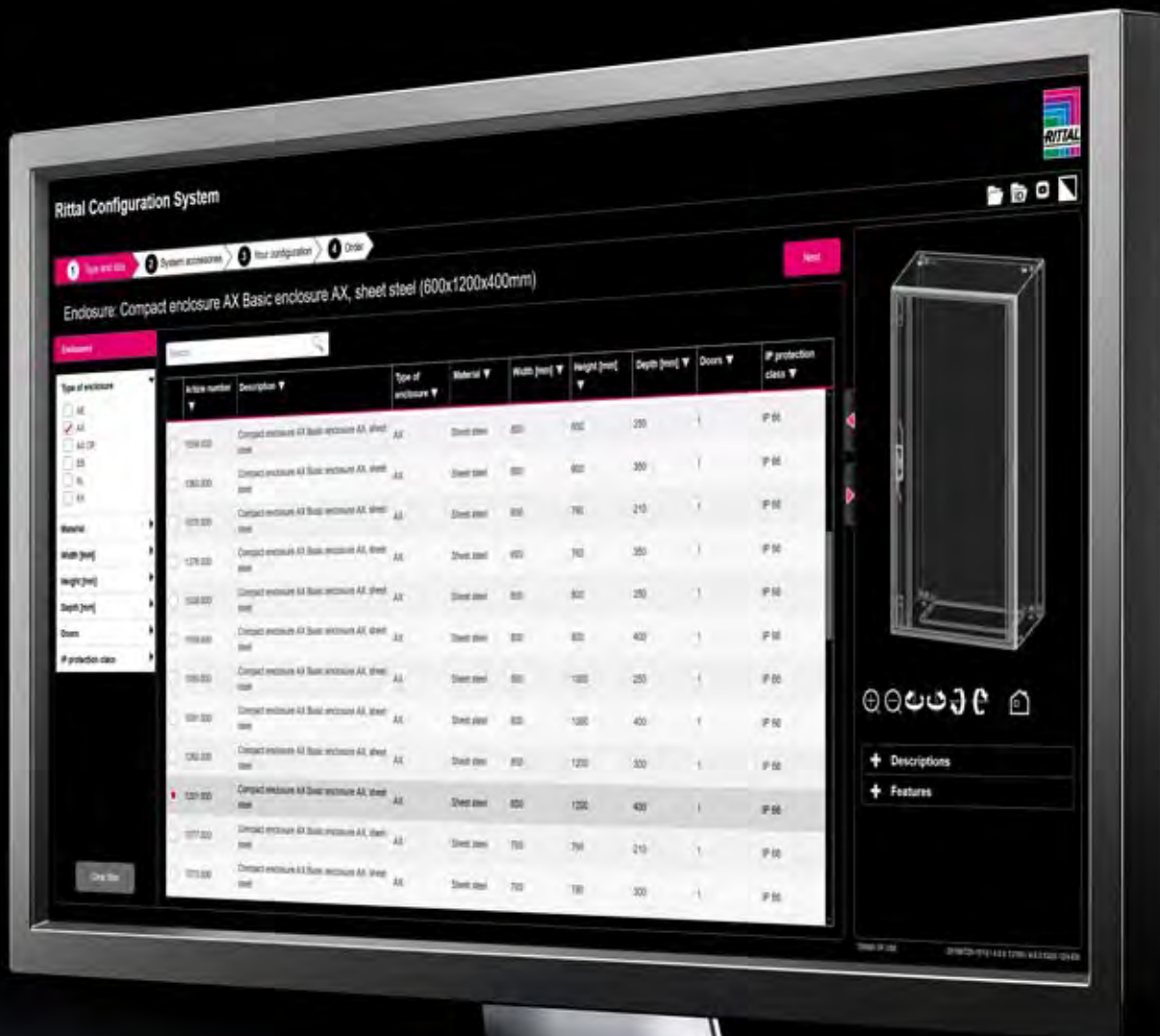

Configure online at www.rittal.com/configurators

Rittal – The System.

Faster – better – everywhere.



Compact enclosures



Compact enclosures AX

Product comparison	74
Product overview	76
Product advantages	78
Basic enclosures AX	84

Plastic enclosures AX

Product comparison	74
Product overview	76
Product advantages	92
Without viewing window	94
With viewing window	95
Accessories	96



Compact enclosures AX – Product comparison



Basic enclosure AX, single-door, sheet steel	Basic enclosure AX, single door, stainless steel	Basic enclosure AX, two-door, sheet steel	
All enclosure panels may be taken directly from the packaging, without dismantling, and machined			
Interior installation on a 25 mm pitch pattern; no machining required			
Wall mounting brackets are easily secured from the outside with a self-tapping screw while retaining the UL	There is no opening to the wall mounting for hygiene reasons, but the position is prepunched and can be drilled without having to measure and mark out	Wall mounting brackets are easily secured from the outside with a self-tapping screw while retaining the UL	
A QR code on the enclosure, door and mounting plate allows seamless monitoring, from receipt of the incoming goods through to delivery of the finished product			
Simple earthing, even retrospectively, using machined keyholes in the mounting plate, and in the case of sheet steel enclosures, in the perforated door strip			
For enclosures with a cam lock, the door and cam locks are rapidly fitted with no need for tools. For enclosures with 3-point locking system, the doors and locks are fully assembled. The locked door is easily relocated without machining the enclosure.			
Up to 33% larger gland plates support cable entry with ever-higher packing densities	The fully sealed base ensures a high protection category of up to IP 66	Up to 33% larger gland plates support cable entry with ever-higher packing densities	
The three-phase surface treatment provides optimum protection against corrosion and is resistant to mineral oils, lubricants, machining emulsions and many solvents	Stainless steel 1.4301 (AISI 304) and stainless steel 1.4404 (AISI 316L) meet maximum hygiene and corrosion protection requirements	The three-phase surface treatment provides optimum protection against corrosion and is resistant to mineral oils, lubricants, machining emulsions and many solvents	
from page 84	from page 236	from page 84	

Compact enclosures AX – Product comparison



	Basic enclosure AX, two-door, sheet steel	Plastic enclosure AX, without viewing window	Plastic enclosure AX, with viewing window
	All enclosure panels may be taken directly from the packaging, without dismantling, and machined	Fully preassembled enclosure	
	Interior installation on a 25 mm pitch pattern; no machining required	Numerous mounting lugs for direct mounting of punched sections and rails for interior installation on a 25 mm pitch pattern	
	There is no opening to the wall mounting for hygiene reasons, but the position is prepunched and can be drilled without having to measure and mark out	The wall mounting brackets are easily secured from the outside while retaining the UL	
	A QR code on the enclosure, door and mounting plate allows seamless monitoring, from receipt of the incoming goods through to delivery of the finished product		
	Simple earthing, even retrospectively, using machined keyholes in the mounting plate and perforated door strip	Simple earthing of the mounting plate, even retrospectively, using machined keyholes	
	The cam locks are rapidly fitted with no need for tools. For enclosures with a locking rod, the doors and locks are fully assembled.	The door hinge is easily swapped from right to left. The integral rain protection strip on the top and bottom of the door provides a double sealing level. The standard double-bit lock insert is easily exchanged for type A lock inserts.	
	The fully sealed base ensures a high protection category of up to IP 55	All-round cable entry is supported with the modular sealing frame and cable glands	
	Stainless steel 1.4301 (AISI 304) and stainless steel 1.4404 (AISI 316L) meet maximum hygiene and corrosion protection requirements	The enclosure is made from fibreglass-reinforced, UL-certified plastic with a high level of chemical and UV resistance, all-insulated and suitable for outdoor applications	
	from page 236	Page 94	Page 95

Compact enclosures AX – Product overview



				Basic enclosures AX			
Height x depth mm	Width mm	Doors	Lock system	Model No.	Model No.		
Material				Sheet steel	Stainless steel 1.4301 (AISI 304)	Stainless steel 1.4404 (AISI 316L)	
300 x 210	300	1	1/□	1033.000	1003.000	-	
	380	1	1/□	1031.000	1011.000	-	
350 x 150	250	-	-	-	-	-	
	300	1	1/□	-	1005.000	1302.000	
380 x 210	380	1	1/□	1380.000	1006.000	1303.000	
	600	1	1/□	1039.000	1009.000	-	
380 x 350	600	1	1/□	1339.000	-	-	
400 x 200	300	-	-	-	-	-	
	400	-	-	-	-	-	
400 x 210	300	1	1/□	1034.000	-	-	
500 x 210	400	1	2/□	1045.000	1015.000	-	
	500	1	2/□	1050.000	1007.000	-	
500 x 300	500	1	2/□	1350.000	1013.000	-	
600 x 200	400	-	-	-	-	-	
	600	-	-	-	-	-	
600 x 210	380	1	2/□	1038.000	1008.000	-	
	600	1	2/□	1060.000	1010.000	1304.000	
600 x 250	600	1	2/□	1054.000	-	-	
600 x 300	800	1	2/□	1055.000	-	-	
600 x 350	380	1	2/□	1338.000	-	-	
	600	1	2/□	1360.000	-	-	
700 x 250	500	1	2/□	1057.000	-	-	
760 x 210	600	1	2/□	1076.000	1012.000	-	
	760	1	2/□	1077.000	-	-	
	1000	2	2/□	1100.000	-	-	
760 x 300	760	1	2/□	1073.000	1014.000	-	
	1000	2	2/□	1130.000	-	-	
760 x 350	600	1	2/□	1376.000	-	-	
800 x 250	600	1	2/□	1058.000	-	-	
800 x 300	400	1	2/□	1037.000	-	-	
	600	-	-	-	-	-	
800 x 400	600	1	2/□	1059.000	-	-	
1000 x 250	600	1	2/□	1090.000	-	-	
1000 x 300	800	1	2/□	1180.000	1016.000	-	
	1000	2	2/□	1110.000	1018.000	-	
1000 x 400	600	1	2/□	1091.000	-	-	
	800	1	2/□	1181.000	-	-	
1200 x 300	600	1	■	1260.000	-	-	
	800	1	■	1280.000	1017.000	-	
	1000	2	■	1213.000	1019.000	1305.000	
1200 x 400	600	1	■	1261.000	-	-	
	800	1	■	1281.000	-	-	
	1000	2	■	1214.000	-	-	
	1200	2	■	1116.000	-	-	
1400 x 300	1000	2	■	1114.000	-	-	
1400 x 400	1000	2	■	1115.000	-	-	
from page				84	236	236	

□ Cam lock ■ 3-point locking system

Compact enclosures AX – Product overview



				Plastic enclosures AX, without viewing window	Plastic enclosures AX, with viewing window	
	Width mm	Doors	Lock system	Model No.	Model No.	
				Fibreglass-reinforced unsaturated polyester	Fibreglass-reinforced unsaturated polyester	
	300	–	–	–	–	
	380	–	–	–	–	
	250	1	1/□	1432.000	–	
	300	–	–	–	–	
	380	–	–	–	–	
	600	–	–	–	–	
	600	–	–	–	–	
	300	1	2/□	1434.000	–	
	400	1	2/□	1444.000	1448.000	
	300	–	–	–	–	
	400	–	–	–	–	
	500	–	–	–	–	
	500	1	2/□	1453.000	1454.000	
	400	1	2/□	1446.000	1449.000	
	600	1	2/□	1466.000	1467.000	
	380	–	–	–	–	
	600	–	–	–	–	
	600	–	–	–	–	
	800	–	–	–	–	
	380	–	–	–	–	
	600	–	–	–	–	
	500	–	–	–	–	
	600	–	–	–	–	
	760	–	–	–	–	
	1000	–	–	–	–	
	760	–	–	–	–	
	1000	–	–	–	–	
	600	–	–	–	–	
	600	–	–	–	–	
	400	–	–	–	–	
	600	1	2/□	1468.000	1469.000	
	600	–	–	–	–	
	600	–	–	–	–	
	800	1	3/□	1480.000	1479.000	
	1000	–	–	–	–	
	600	–	–	–	–	
	800	–	–	–	–	
	600	–	–	–	–	
	800	–	–	–	–	
	1000	–	–	–	–	
	600	–	–	–	–	
	800	–	–	–	–	
	1000	–	–	–	–	
	1200	–	–	–	–	
	1000	–	–	–	–	
	1000	–	–	–	–	
				94	95	

□ Cam lock ■ 3-point locking system

Compact enclosures AX – Added protection



Flexibility/stability

- The integrated locators in the enclosure support the use of an interior installation rail for time-saving, precise installation with Rittal punched sections with mounting flanges and accessories.
- The height-flexible, form-fit rail used in the continuous pattern of locators for interior installation increases stability, especially with dynamic loads.

Protection

- The deliberately slimline enclosure edge fold provides broad, secure contact with the seamless PU foam seal and helps preserve the protection category (up to IP 66) and protection class IK 10.

Potential equalisation

- Special drilled holes in the gland plate ensure automatic potential equalisation during screw-fastening, which saves time and materials as well as enhancing safety.

Ease of assembly

- The standard eyelet in the rear panel allows rapid screw-fastening of the wall mounting bracket from the outside with a self-tapping screw; no need for a lock nut on the inside. The high protection category is retained in full.



Compact enclosures AX – Added efficiency



Ease of installation/flexibility

- Tool-free installation of the doors saves extra time. Simply position the door, press down on the hinge pin, and it's done.
- The AX door hinge allows you to swap the hinge to the opposite side, even with two-door enclosures, without any machining of the enclosure. This allows simple, fast relocation of the lockable door while the space-saving door population translates into extra space gains.



Area extension

- The perforated door strip with U extrusion and system punchings on a flexible 25 mm pitch pattern allows fast, simple extension of the installation area. Because it is compatible with Rittal system accessories, no door machining is required.



Time savings/rapid assembly

- Cam locks are supplied loose to allow unobstructed machining of the door. No time-consuming dismantling work is required in advance.
- Lock installation is fast and tool-free. Simply insert, lock into place, and voilà!



The perfect fit

- The runner on the perforated door strip ensures that even heavily populated doors fit precisely and are compliant with the protection category.



Compact enclosures AX – Added system benefits



Reliable engineering

- A wide range of conversion and planning tools are available to Rittal customers to support them with the automated production process and when working with a virtual prototype:
 - Configurators
 - Parts list converters
 - EPLAN Pro Panel
 - 2D/3D CAD data
 - ecl@ss Advanced
 - Technical documentation
 - Data for planners
 - Assembly videos

Digitalization

- The QR code on all machinable enclosure panels permits fully automated incorporation into the production workflow, for seamless digital monitoring from the incoming goods right through to the finished product.

Diverse industries

- The choice of sheet steel or stainless steel allows the AX to be used in any industry, at any location, in any climate, in any environment, and in a wide range of individual applications.

Time savings

- The process-optimised packaging concept means it can go straight into production, because all panels and cam locks are supplied unfitted, so no dismantling is required.

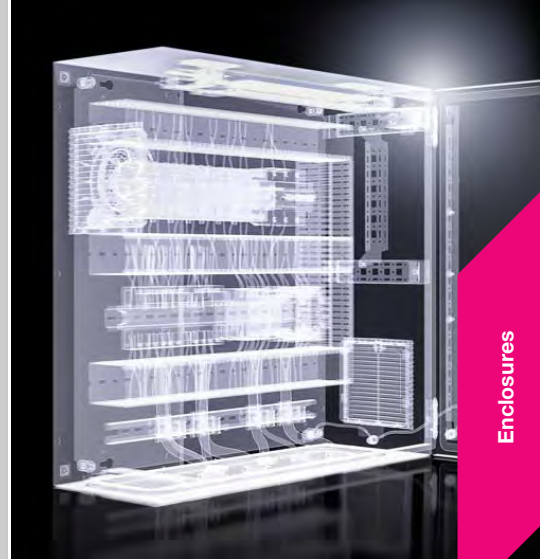

Enclosures



Compact enclosures AX



System accessories Page 877 AX stainless steel Page 236 AX plastic Page 92 Hygienic Design Page 217 Outdoor housing Page 958

Material:

- Enclosure: Sheet steel
- Door: Sheet steel, all-round foamed-in PU seal

Surface finish:

- Enclosure and door: Dipcoat-primed, powder-coated on the outside, textured paint
- Mounting plate: Zinc-plated

Colour:

- RAL 7035

Supply includes:

- Enclosure with door(s)
 - Gland plate(s) in enclosure base
 - Mounting plate
 - Perforated door strip
 - Lock: 3 mm double-bit
- Please note the product-specific scope of supply.

Approvals:

- UL
 - cUL
- Further approvals can be found on the Internet.

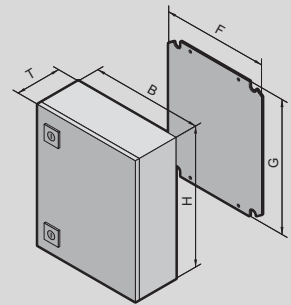

Basic enclosure AX, sheet steel

Width (B) mm	Packs of	300	300	Page
Height (H) mm		300	400	
Depth (T) mm		210	210	
Mounting plate width (F) mm		250	250	
Mounting plate height (G) mm		275	375	
Material thickness – enclosure mm		1.25	1.25	
Material thickness – door mm		1.5	1.5	
Material thickness – mounting plate mm		2.0	2.0	
Model No.	1 pc(s).	1033.000	1034.000	
Weight kg		6.7	8.38	
Protection category IP to IEC 60 529		IP 66	IP 66	
Protection category NEMA		NEMA 4	NEMA 4	
Product-specific scope of supply				
Door(s)		1	1	
Door hinged on the right, may be swapped to the left		■	■	
Gland plate, size		1	1	
Gland plate, qty		1	1	
Cam lock		1	1	
Accessories				
Wall mounting bracket, for AX sheet steel, KX sheet steel, wall distance 20 mm	4 pc(s).	2508.020	2508.020	966
Wall mounting bracket, for AX sheet steel, KX sheet steel, wall distance 40 mm	4 pc(s).	2503.020	2503.020	966
Wall angle	4 pc(s).	2505.510	2505.510	967
Pole clamp	2 pc(s).	2584.100	2584.100	968
Plastic gland plate, modular	1 pc(s).	2561.200	2561.200	1050
Plastic gland plate with membranes	1 pc(s).	2561.300	2561.300	1052
Metal gland plate with knockouts	1 pc(s).	2571.100	2571.100	1053
Sealing frame, modular		see page	see page	1048
Rail for interior installation	4 pc(s).	2393.210	2393.210	989
Support strips, installation in the door		–	–	
Punched section with mounting flange 14 x 39 mm, installation in the height	4 pc(s).	–	8619.700	990
Punched section with mounting flange 14 x 39 mm, installation in the door		–	–	
LED system light		–	–	
Mini-comfort handle AX for lock inserts or profile half-cylinders	1 pc(s).	2537.100	2537.100	940
Mini-comfort handle AX for padlock and lock inserts or profile half-cylinders	1 pc(s).	2537.300	2537.300	940
Comfort handle AX for lock inserts or profile half-cylinders		–	–	
Comfort handle AX for padlock and lock inserts or profile half-cylinders		–	–	
Lock inserts		see page	see page	941, 942
Viewing window, depth 36 mm		–	–	
Viewing window, depth 62 mm		–	–	
Operating panel		–	–	
180° hinge	3 pc(s).	2449.010	2449.010	951
Door stay	1 pc(s).	2519.010	2519.010	956
Sheet steel wiring plan pockets, width-variable		–	–	
Plastic wiring plan pockets		see page	see page	955
Wiring plan pockets with transparent pouch		see page	see page	955
Base/plinth corner pieces with base/plinth trim panels, front and rear, 100 mm		–	–	
Base/plinth trim panels, sides, 100 mm		–	–	
Base/plinth corner pieces with base/plinth trim panels, front and rear, 200 mm		–	–	
Base/plinth trim panels, sides, 200 mm		–	–	
Eyebolts		–	–	
Protective roof	1 pc(s).	2361.010	2361.010	958
Dust guard trim	1 pc(s).	2426.500	2426.500	959
Earth straps		see page	see page	1033
Baying kit	1 pc(s).	1199.100	1199.100	916
Cable gland, brass		see page	see page	1056
Cable gland, polyamide		see page	see page	1056

Compact enclosures AX

Basic enclosure AX, sheet steel

Width (B) mm	Packs of	380	380	380	380	400	400	Page
Height (H) mm		300	380	600	600	500	800	
Depth (T) mm		210	210	210	350	210	300	
Mounting plate width (F) mm		330	330	330	330	350	345	
Mounting plate height (G) mm		275	355	575	575	475	775	
Material thickness – enclosure mm		1.25	1.25	1.25	1.5	1.25	1.5	
Material thickness – door mm		1.5	1.5	1.5	1.5	1.5	2.0	
Material thickness – mounting plate mm		2.0	2.0	2.5	2.5	2.0	2.5	
Model No.	1 pc(s).	1031.000	1380.000	1038.000	1338.000	1045.000	1037.000	
Weight kg		8.8	9.48	14.4	18.6	12.1	24.9	
Protection category IP to IEC 60 529		IP 66	IP 66	IP 66	IP 66	IP 66	IP 66	
Protection category NEMA		NEMA 4	NEMA 4	NEMA 4	NEMA 4	NEMA 4	NEMA 4	
Product-specific scope of supply								
Door(s)		1	1	1	1	1	1	
Door hinged on the right, may be swapped to the left		■	■	■	■	■	■	
Gland plate, size		2	2	2	5	2	5	
Gland plate, qty		1	1	1	1	1	1	
Cam lock		1	1	2	2	2	2	
Accessories								
Wall mounting bracket, for AX sheet steel, KX sheet steel, wall distance 20 mm	4 pc(s).	2508.020	2508.020	2508.020	2508.020	2508.020	2508.020	966
Wall mounting bracket, for AX sheet steel, KX sheet steel, wall distance 40 mm	4 pc(s).	2503.020	2503.020	2503.020	2503.020	2503.020	2503.020	966
Wall angle	4 pc(s).	2505.510	2505.510	2505.510	2505.510	2505.510	2505.510	967
Pole clamp	2 pc(s).	2584.100	2584.100	2584.100	2584.100	2584.100	2584.100	968
Plastic gland plate, modular	1 pc(s).	2562.200	2562.200	2562.200	2565.200	2562.200	2565.200	1050
Plastic gland plate with membranes	1 pc(s).	2562.300	2562.300	2562.300	2565.300	2562.300	2565.300	1052
Metal gland plate with knockouts	1 pc(s).	2572.100	2572.100	2572.100	2575.100	2572.100	2575.100	1053
Sealing frame, modular		see page	see page	see page	see page	see page	see page	1048
Rail for interior installation	4 pc(s).	2393.210	2393.210	2393.210	2393.350	2393.210	2393.300	989
Support strips, installation in the door	20 pc(s).	4599.100	4599.100	4599.100	4599.100	4694.000	4694.000	952
Punched section with mounting flange 14 x 39 mm, installation in the height	4 pc(s).	–	–	–	–	8619.710	8619.730	990
Punched section with mounting flange 14 x 39 mm, installation in the door		–	–	–	–	–	–	
LED system light	1 pc(s).	–	–	–	–	2500.100	2500.100	1014
Mini-comfort handle AX for lock inserts or profile half-cylinders	1 pc(s).	2537.100	2537.100	2537.100	2537.100	2537.100	2537.100	940
Mini-comfort handle AX for padlock and lock inserts or profile half-cylinders	1 pc(s).	2537.300	2537.300	2537.300	2537.300	2537.300	2537.300	940
Comfort handle AX for lock inserts or profile half-cylinders		–	–	–	–	–	–	
Comfort handle AX for padlock and lock inserts or profile half-cylinders		–	–	–	–	–	–	
Lock inserts		see page	see page	see page	see page	see page	see page	941, 942
Viewing window, depth 36 mm		–	–	–	–	–	–	
Viewing window, depth 62 mm		–	–	–	–	–	–	
Operating panel	1 pc(s).	2741.010	2742.010	2743.010	2743.010	–	–	931
180° hinge	3 pc(s).	2449.010	2449.010	2449.010	2449.010	2449.010	2449.010	951
Door stay	1 pc(s).	2519.010	2519.010	2519.010	2519.010	2519.010	2519.010	956
Sheet steel wiring plan pockets, width-variable	1 pc(s).	–	–	–	–	2515.200	2515.200	954
Plastic wiring plan pockets		see page	see page	see page	see page	see page	see page	955
Wiring plan pockets with transparent pouch		see page	see page	see page	see page	see page	see page	955
Base/plinth corner pieces with base/plinth trim panels, front and rear, 100 mm		–	–	–	–	–	–	
Base/plinth trim panels, sides, 100 mm		–	–	–	–	–	–	
Base/plinth corner pieces with base/plinth trim panels, front and rear, 200 mm		–	–	–	–	–	–	
Base/plinth trim panels, sides, 200 mm		–	–	–	–	–	–	
Eyebolts		–	–	–	–	–	–	
Protective roof	1 pc(s).	2472.010	2472.010	2472.010	–	–	–	958
Dust guard trim	1 pc(s).	2426.500	2426.500	2426.500	2426.500	2426.500	2426.500	959
Earth straps		see page	see page	see page	see page	see page	see page	1033
Baying kit	1 pc(s).	1199.100	1199.100	1199.100	1199.100	1199.100	1199.100	916
Cable gland, brass		see page	see page	see page	see page	see page	see page	1056
Cable gland, polyamide		see page	see page	see page	see page	see page	see page	1056

Basic enclosure AX, sheet steel

Width (B) mm	Packs of	500	500	500	600	600	600	Page
Height (H) mm		500	500	700	380	380	600	
Depth (T) mm		210	300	250	210	350	210	
Mounting plate width (F) mm		450	450	450	550	550	550	
Mounting plate height (G) mm		475	475	675	355	355	575	
Material thickness – enclosure mm		1.25	1.5	1.5	1.25	1.5	1.5	
Material thickness – door mm		1.5	1.5	2.0	1.5	1.5	1.5	
Material thickness – mounting plate mm		2.5	2.5	2.5	2.5	2.5	2.5	
Model No.	1 pc(s).	1050.000	1350.000	1057.000	1039.000	1339.000	1060.000	
Weight kg		15.4	19.0	25.0	14.4	8.7	22.3	
Protection category IP to IEC 60 529		IP 66	IP 66	IP 66	IP 66	IP 66	IP 66	
Protection category NEMA		NEMA 4	NEMA 4	NEMA 4	NEMA 4	NEMA 4	NEMA 4	
Product-specific scope of supply								
Door(s)		1	1	1	1	1	1	
Door hinged on the right, may be swapped to the left		■	■	■	■	■	■	
Gland plate, size		3	6	3	4	7	4	
Gland plate, qty		1	1	1	1	1	1	
Cam lock		2	2	2	1	1	2	
Accessories								
Wall mounting bracket, for AX sheet steel, KX sheet steel, wall distance 20 mm	4 pc(s).	2508.020	2508.020	2508.020	2508.020	2508.020	2508.020	966
Wall mounting bracket, for AX sheet steel, KX sheet steel, wall distance 40 mm	4 pc(s).	2503.020	2503.020	2503.020	2503.020	2503.020	2503.020	966
Wall angle	4 pc(s).	2505.510	2505.510	2505.510	2505.510	2505.510	2505.510	967
Pole clamp	2 pc(s).	2584.100	2584.100	2584.100	2584.100	2584.100	2584.100	968
Plastic gland plate, modular	1 pc(s).	2563.200	2566.200	2563.200	2564.200	2567.200	2564.200	1050
Plastic gland plate with membranes	1 pc(s).	2563.300	2566.300	2563.300	2564.300	2567.300	2564.300	1052
Metal gland plate with knockouts	1 pc(s).	2573.100	2576.100	2573.100	2574.100	2577.100	2574.100	1053
Sealing frame, modular		see page	see page	see page	see page	see page	see page	1048
Rail for interior installation	4 pc(s).	2393.210	2393.300	2393.250	2393.210	2393.350	2393.210	989
Support strips, installation in the door	20 pc(s).	4695.000	4695.000	4695.000	4696.000	4696.000	4696.000	952
Punched section with mounting flange 14 x 39 mm, installation in the height	4 pc(s).	8619.710	8619.710	8619.760	–	–	8619.720	990
Punched section with mounting flange 14 x 39 mm, installation in the door		–	–	–	–	–	–	
LED system light	1 pc(s).	2500.100	2500.100	2500.100	2500.100	2500.100	2500.100	1014
Mini-comfort handle AX for lock inserts or profile half-cylinders	1 pc(s).	2537.100	2537.100	2537.100	2537.100	2537.100	2537.100	940
Mini-comfort handle AX for padlock and lock inserts or profile half-cylinders	1 pc(s).	2537.300	2537.300	2537.300	2537.300	2537.300	2537.300	940
Comfort handle AX for lock inserts or profile half-cylinders		–	–	–	–	–	–	
Comfort handle AX for padlock and lock inserts or profile half-cylinders		–	–	–	–	–	–	
Lock inserts		see page	see page	see page	see page	see page	see page	941, 942
Viewing window, depth 36 mm	1 pc(s).	2733.010	2733.010	–	2730.010	2730.010	2731.010	930
Viewing window, depth 62 mm	1 pc(s).	2763.010	2763.010	–	2760.010	2760.010	2761.010	930
Operating panel	1 pc(s).	2745.010	2745.010	–	2744.010	–	2746.010	931
180° hinge	3 pc(s).	2449.010	2449.010	2449.010	2449.010	2449.010	2449.010	951
Door stay	1 pc(s).	2519.010	2519.010	2519.010	2519.010	2519.010	2519.010	956
Sheet steel wiring plan pockets, width-variable	1 pc(s).	2515.200	2515.200	2515.200	2515.300	2515.300	2515.300	954
Plastic wiring plan pockets		see page	see page	see page	see page	see page	see page	955
Wiring plan pockets with transparent pouch		see page	see page	see page	see page	see page	see page	955
Base/plinth corner pieces with base/plinth trim panels, front and rear, 100 mm		–	–	–	–	–	–	
Base/plinth trim panels, sides, 100 mm		–	–	–	–	–	–	
Base/plinth corner pieces with base/plinth trim panels, front and rear, 200 mm		–	–	–	–	–	–	
Base/plinth trim panels, sides, 200 mm		–	–	–	–	–	–	
Eyebolts		–	–	–	–	–	–	
Protective roof	1 pc(s).	2362.010	–	–	2473.010	–	2473.010	958
Dust guard trim	1 pc(s).	2426.500	2426.500	2426.500	2426.500	2426.500	2426.500	959
Earth straps		see page	see page	see page	see page	see page	see page	1033
Baying kit	1 pc(s).	1199.100	1199.100	1199.100	1199.100	1199.100	1199.100	916
Cable gland, brass		see page	see page	see page	see page	see page	see page	1056
Cable gland, polyamide		see page	see page	see page	see page	see page	see page	1056

Compact enclosures AX

Basic enclosure AX, sheet steel

Width (B) mm	Packs of	600	600	600	600	600	600	Page
Height (H) mm		600	600	760	760	800	800	
Depth (T) mm		250	350	210	350	250	400	
Mounting plate width (F) mm		550	550	550	550	545	545	
Mounting plate height (G) mm		575	575	735	735	775	775	
Material thickness – enclosure mm		1.5	1.5	1.5	1.5	1.5	1.5	
Material thickness – door mm		1.5	1.5	2.0	2.0	2.0	2.0	
Material thickness – mounting plate mm		2.5	2.5	2.5	2.5	2.5	2.5	
Model No.	1 pc(s).	1054.000	1360.000	1076.000	1376.000	1058.000	1059.000	
Weight kg		23.4	26.3	29.5	34.0	32.0	40.0	
Protection category IP to IEC 60 529		IP 66	IP 66	IP 66	IP 66	IP 66	IP 66	
Protection category NEMA		NEMA 4	NEMA 4	NEMA 4	NEMA 4	NEMA 4	NEMA 4	
Product-specific scope of supply								
Door(s)		1	1	1	1	1	1	
Door hinged on the right, may be swapped to the left		■	■	■	■	■	■	
Gland plate, size		4	7	4	7	4	7	
Gland plate, qty		1	1	1	1	1	1	
Cam lock		2	2	2	2	2	2	
Accessories								
Wall mounting bracket, for AX sheet steel, KX sheet steel, wall distance 20 mm	4 pc(s).	2508.020	2508.020	2508.020	2508.020	2508.020	2508.020	966
Wall mounting bracket, for AX sheet steel, KX sheet steel, wall distance 40 mm	4 pc(s).	2503.020	2503.020	2503.020	2503.020	2503.020	2503.020	966
Wall angle	4 pc(s).	2505.510	2505.510	2505.510	2505.510	2505.510	2505.510	967
Pole clamp	2 pc(s).	2584.100	2584.100	2584.100	2584.100	2584.100	2584.100	968
Plastic gland plate, modular	1 pc(s).	2564.200	2567.200	2564.200	2567.200	2564.200	2567.200	1050
Plastic gland plate with membranes	1 pc(s).	2564.300	2567.300	2564.300	2567.300	2564.300	2567.300	1052
Metal gland plate with knockouts	1 pc(s).	2574.100	2577.100	2574.100	2577.100	2574.100	2577.100	1053
Sealing frame, modular		see page	see page	see page	see page	see page	see page	1048
Rail for interior installation	4 pc(s).	2393.250	2393.350	2393.210	2393.350	2393.250	2393.400	989
Support strips, installation in the door	20 pc(s).	4696.000	4696.000	4696.000	4696.000	4696.000	4696.000	952
Punched section with mounting flange 14 x 39 mm, installation in the height	4 pc(s).	8619.720	8619.720	8619.790	8619.790	8619.730	8619.730	990
Punched section with mounting flange 14 x 39 mm, installation in the door		-	-	-	-	-	-	
LED system light	1 pc(s).	2500.100	2500.100	2500.100	2500.100	2500.110	2500.110	1014
Mini-comfort handle AX for lock inserts or profile half-cylinders	1 pc(s).	2537.100	2537.100	2537.100	2537.100	2537.100	2537.100	940
Mini-comfort handle AX for padlock and lock inserts or profile half-cylinders	1 pc(s).	2537.300	2537.300	2537.300	2537.300	2537.300	2537.300	940
Comfort handle AX for lock inserts or profile half-cylinders		-	-	-	-	-	-	
Comfort handle AX for padlock and lock inserts or profile half-cylinders		-	-	-	-	-	-	
Lock inserts		see page	see page	see page	see page	see page	see page	941, 942
Viewing window, depth 36 mm	1 pc(s).	2731.010	2731.010	2732.010	2732.010	-	-	930
Viewing window, depth 62 mm	1 pc(s).	2761.010	2761.010	2762.010	2762.010	-	-	930
Operating panel	1 pc(s).	2746.010	2746.010	-	-	-	-	931
180° hinge	3 pc(s).	2449.010	2449.010	2449.010	2449.010	2449.010	2449.010	951
Door stay	1 pc(s).	2519.010	2519.010	2519.010	2519.010	2519.010	2519.010	956
Sheet steel wiring plan pockets, width-variable	1 pc(s).	2515.300	2515.300	2515.300	2515.300	2515.300	2515.300	954
Plastic wiring plan pockets		see page	see page	see page	see page	see page	see page	955
Wiring plan pockets with transparent pouch		see page	see page	see page	see page	see page	see page	955
Base/plinth corner pieces with base/plinth trim panels, front and rear, 100 mm	2 pc(s).	-	-	-	-	-	2820.061	888
Base/plinth trim panels, sides, 100 mm	2 pc(s).	-	-	-	-	-	2820.410	889
Base/plinth corner pieces with base/plinth trim panels, front and rear, 200 mm	2 pc(s).	-	-	-	-	-	2820.062	888
Base/plinth trim panels, sides, 200 mm	2 pc(s).	-	-	-	-	-	2820.420	889
Eyebolts	2 pc(s).	-	-	-	-	-	2509.010	964
Protective roof	1 pc(s).	-	2476.010	2473.010	2476.010	-	-	958
Dust guard trim	1 pc(s).	2426.500	2426.500	2426.500	2426.500	2426.500	2426.500	959
Earth straps		see page	see page	see page	see page	see page	see page	1033
Baying kit	1 pc(s).	1199.100	1199.100	1199.100	1199.100	1199.100	1199.100	916
Cable gland, brass		see page	see page	see page	see page	see page	see page	1056
Cable gland, polyamide		see page	see page	see page	see page	see page	see page	1056

Basic enclosure AX, sheet steel

Width (B) mm	Packs of	600	600	600	600	760	760	Page
Height (H) mm		1000	1000	1200	1200	760	760	
Depth (T) mm		250	400	300	400	210	300	
Mounting plate width (F) mm		545	545	545	545	705	705	
Mounting plate height (G) mm		975	975	1175	1175	735	735	
Material thickness – enclosure mm		1.5	1.5	1.5	1.5	1.5	1.5	
Material thickness – door mm		2.0	2.0	2.0	2.0	2.0	2.0	
Material thickness – mounting plate mm		2.5	2.5	2.5	2.5	2.5	2.5	
Model No.	1 pc(s).	1090.000	1091.000	1260.000	1261.000	1077.000	1073.000	
Weight kg		39.5	50.0	50.0	56.0	36.7	42.0	
Protection category IP to IEC 60 529		IP 66	IP 66	IP 66	IP 66	IP 66	IP 66	
Protection category NEMA		NEMA 4	NEMA 4	NEMA 4	NEMA 4	NEMA 4	NEMA 4	
Product-specific scope of supply								
Door(s)		1	1	1	1	1	1	
Door hinged on the right, may be swapped to the left		■	■	■	■	■	■	
Gland plate, size		4	7	7	7	2	5	
Gland plate, qty		1	1	1	1	2	2	
Cam lock		2	2	–	–	2	2	
3-point lock system		–	–	■	■	–	–	
Accessories								
Wall mounting bracket, for AX sheet steel, KX sheet steel, wall distance 20 mm	4 pc(s).	2508.020	2508.020	2508.020	2508.020	2508.020	2508.020	966
Wall mounting bracket, for AX sheet steel, KX sheet steel, wall distance 40 mm	4 pc(s).	2503.020	2503.020	2503.020	2503.020	2503.020	2503.020	966
Wall angle	4 pc(s).	2505.510	2505.510	2505.510	2505.510	2505.510	2505.510	967
Pole clamp	2 pc(s).	2584.100	2584.100	2584.100	2584.100	–	–	968
Plastic gland plate, modular	1 pc(s).	2564.200	2567.200	2567.200	2567.200	2562.200	2565.200	1050
Plastic gland plate with membranes	1 pc(s).	2564.300	2567.300	2567.300	2567.300	2562.300	2565.300	1052
Metal gland plate with knockouts	1 pc(s).	2574.100	2577.100	2577.100	2577.100	2572.100	2575.100	1053
Sealing frame, modular		see page	see page	see page	see page	see page	see page	1048
Rail for interior installation	4 pc(s).	2393.250	2393.400	2393.300	2393.400	2393.210	2393.300	989
Support strips, installation in the door	20 pc(s).	4696.000	4696.000	4596.000	4596.000	4599.200	4599.200	952
Punched section with mounting flange 14 x 39 mm, installation in the height	4 pc(s).	8619.750	8619.750	8619.770	8619.770	8619.790	8619.790	990
Punched section with mounting flange 14 x 39 mm, installation in the door	4 pc(s).	–	–	8619.720	8619.720	–	–	952
LED system light	1 pc(s).	2500.110	2500.110	2500.110	2500.110	2500.110	2500.110	1014
Mini-comfort handle AX for lock inserts or profile half-cylinders	1 pc(s).	2537.100	2537.100	–	–	2537.100	2537.100	940
Mini-comfort handle AX for padlock and lock inserts or profile half-cylinders	1 pc(s).	2537.300	2537.300	–	–	2537.300	2537.300	940
Comfort handle AX for lock inserts or profile half-cylinders	1 pc(s).	–	–	2435.100	2435.100	–	–	939
Comfort handle AX for padlock and lock inserts or profile half-cylinders	1 pc(s).	–	–	2435.400	2435.400	–	–	939
Lock inserts		see page	see page	see page	see page	see page	see page	941, 942
Viewing window, depth 36 mm		–	–	–	–	–	–	
Viewing window, depth 62 mm		–	–	–	–	–	–	
Operating panel		–	–	–	–	–	–	
180° hinge	3 pc(s).	2449.010	2449.010	2449.010	2449.010	2449.010	2449.010	951
Door stay	1 pc(s).	2519.010	2519.010	2519.010	2519.010	2519.010	2519.010	956
Sheet steel wiring plan pockets, width-variable	1 pc(s).	2515.300	2515.300	2515.300	2515.300	2515.400	2515.400	954
Plastic wiring plan pockets		see page	see page	see page	see page	see page	see page	955
Wiring plan pockets with transparent pouch		see page	see page	see page	see page	see page	see page	955
Base/plinth corner pieces with base/plinth trim panels, front and rear, 100 mm	2 pc(s).	–	2820.061	2820.061	2820.061	–	–	888
Base/plinth trim panels, sides, 100 mm	2 pc(s).	–	2820.410	2820.310	2820.410	–	–	889
Base/plinth corner pieces with base/plinth trim panels, front and rear, 200 mm	2 pc(s).	–	2820.062	2820.062	2820.062	–	–	888
Base/plinth trim panels, sides, 200 mm	2 pc(s).	–	2820.420	2820.320	2820.420	–	–	889
Eyebolts	2 pc(s).	–	2509.010	2509.010	2509.010	–	–	964
Protective roof	1 pc(s).	–	–	–	–	–	2474.010	958
Dust guard trim	1 pc(s).	2426.500	2426.500	2426.500	2426.500	2426.500	2426.500	959
Earth straps		see page	see page	see page	see page	see page	see page	1033
Baying kit	1 pc(s).	1199.100	1199.100	1199.100	1199.100	1199.100	1199.100	916
Cable gland, brass		see page	see page	see page	see page	see page	see page	1056
Cable gland, polyamide		see page	see page	see page	see page	see page	see page	1056

Compact enclosures AX

Basic enclosure AX, sheet steel

Width (B) mm	Packs of	800	800	800	800	800	1000	Page
Height (H) mm		600	1000	1000	1200	1200	760	
Depth (T) mm		300	300	400	300	400	210	
Mounting plate width (F) mm		750	745	745	745	745	945	
Mounting plate height (G) mm		575	975	975	1175	1175	735	
Material thickness – enclosure mm		1.5	1.5	1.5	1.5	1.5	1.5	
Material thickness – door mm		2.0	2.0	2.0	2.0	2.0	2.0	
Material thickness – mounting plate mm		2.5	2.5	2.5	2.5	2.5	2.5	
Model No.	1 pc(s).	1055.000	1180.000	1181.000	1280.000	1281.000	1100.000	
Weight kg		34.2	52.0	59.5	63.5	69.0	49.0	
Protection category IP to IEC 60 529		IP 66	IP 66	IP 66	IP 66	IP 66	IP 55	
Protection category NEMA		NEMA 4	NEMA 4	NEMA 4	NEMA 4	NEMA 4	NEMA 12	
Product-specific scope of supply								
Door(s)		1	1	1	1	1	2	
Door hinged on the right, may be swapped to the left		■	■	■	■	■	■	
Gland plate, size		5	5	5	5	5	3	
Gland plate, qty		2	2	2	2	2	2	
Cam lock		2	2	2	–	–	2	
3-point lock system		–	–	–	■	■	–	
Accessories								
Wall mounting bracket, for AX sheet steel, KX sheet steel, wall distance 20 mm	4 pc(s).	2508.020	2508.020	2508.020	2508.020	2508.020	2508.020	966
Wall mounting bracket, for AX sheet steel, KX sheet steel, wall distance 40 mm	4 pc(s).	2503.020	2503.020	2503.020	2503.020	2503.020	2503.020	966
Wall angle	4 pc(s).	2505.510	2505.510	2505.510	2505.510	2505.510	2505.510	967
Pole clamp	2 pc(s).	2584.100	2584.100	2584.100	2584.100	2584.100	2584.100	968
Plastic gland plate, modular	1 pc(s).	2565.200	2565.200	2565.200	2565.200	2565.200	2562.200	1050
Plastic gland plate with membranes	1 pc(s).	2565.300	2565.300	2565.300	2565.300	2565.300	2563.300	1052
Metal gland plate with knockouts	1 pc(s).	2575.100	2575.100	2575.100	2575.100	2575.100	2573.100	1053
Sealing frame, modular		see page	see page	see page	see page	see page	see page	1048
Rail for interior installation	4 pc(s).	2393.300	2393.300	2393.400	2393.300	2393.400	2393.210	989
Support strips, installation in the door	20 pc(s).	4697.000	4697.000	4697.000	–	–	4695.000	952
Punched section with mounting flange 14 x 39 mm, installation in the height	4 pc(s).	8619.720	8619.750	8619.750	8619.770	8619.770	8619.790	990
Punched section with mounting flange 14 x 39 mm, installation in the door ¹⁾	4 pc(s).	–	–	–	8619.730	8619.730	8619.710	952
LED system light	1 pc(s).	2500.110	2500.110	2500.110	2500.110	2500.110	2500.110	1014
Mini-comfort handle AX for lock inserts or profile half-cylinders	1 pc(s).	2537.100	2537.100	2537.100	–	–	2537.100	940
Mini-comfort handle AX for padlock and lock inserts or profile half-cylinders	1 pc(s).	2537.300	2537.300	2537.300	–	–	2537.300	940
Comfort handle AX for lock inserts or profile half-cylinders	1 pc(s).	–	–	–	2435.100	2435.100	–	939
Comfort handle AX for padlock and lock inserts or profile half-cylinders	1 pc(s).	–	–	–	2435.400	2435.400	–	939
Lock inserts		see page	see page	see page	see page	see page	see page	941, 942
Viewing window, depth 36 mm		–	–	–	–	–	–	
Viewing window, depth 62 mm		–	–	–	–	–	–	
Operating panel		–	–	–	–	–	–	
180° hinge	3 pc(s).	2449.010	2449.010	2449.010	2449.010	2449.010	2449.010	951
Door stay	1 pc(s).	2519.010	2519.010	2519.010	2519.010	2519.010	2519.010	956
Sheet steel wiring plan pockets, width-variable	1 pc(s).	2515.400	2515.400	2515.400	2515.400	2515.400	2515.200	954
Plastic wiring plan pockets		see page	see page	see page	see page	see page	see page	955
Wiring plan pockets with transparent pouch		see page	see page	see page	see page	see page	see page	955
Base/plinth corner pieces with base/plinth trim panels, front and rear, 100 mm	2 pc(s).	2820.081	2820.081	2820.081	2820.081	2820.081	–	888
Base/plinth trim panels, sides, 100 mm	2 pc(s).	2820.310	2820.310	2820.410	2820.310	2820.410	–	889
Base/plinth corner pieces with base/plinth trim panels, front and rear, 200 mm	2 pc(s).	2820.082	2820.082	2820.082	2820.082	2820.082	–	888
Base/plinth trim panels, sides, 200 mm	2 pc(s).	2820.320	2820.320	2820.420	2820.320	2820.420	–	889
Eyebolts	2 pc(s).	–	2509.010	2509.010	2509.010	2509.010	–	964
Protective roof	1 pc(s).	2475.010	2475.010	–	2475.010	–	–	958
Dust guard trim	1 pc(s).	2426.500	2426.500	2426.500	2426.500	2426.500	2426.500	959
Earth straps		see page	see page	see page	see page	see page	see page	1033
Baying kit	1 pc(s).	1199.100	1199.100	1199.100	1199.100	1199.100	1199.100	916
Cable gland, brass		see page	see page	see page	see page	see page	see page	1056
Cable gland, polyamide		see page	see page	see page	see page	see page	see page	1056

¹⁾ For two-door enclosures: Installation in the lockable door

Basic enclosure AX, sheet steel

Width (B) mm	Packs of	1000	1000	1000	1000	1000	1000	1200	Page
Height (H) mm		760	1000	1200	1200	1,400	1,400	1200	
Depth (T) mm		300	300	300	400	300	400	400	
Mounting plate width (F) mm		945	945	945	945	945	945	1145	
Mounting plate height (G) mm		735	975	1175	1175	1375	1375	1175	
Material thickness – enclosure mm		1.5	1.5	1.5	1.5	1.5	1.5	1.5	
Material thickness – door mm		2.0	2.0	2.0	2.0	2.0	2.0	2.0	
Material thickness – mounting plate mm		2.5	2.5	2.5	2.5	2.5	2.5	2.5	
Model No.	1 pc(s).	1130.000	1110.000	1213.000	1214.000	1114.000	1115.000	1116.000	
Weight kg		52.0	63.0	81.0	85.7	88.5	100.0	101.0	
Protection category IP to IEC 60 529		IP 55	IP 55	IP 55	IP 55	IP 55	IP 55	IP 55	
Protection category NEMA		NEMA 12	NEMA 12	NEMA 12	NEMA 12	NEMA 12	NEMA 12	NEMA 12	
Product-specific scope of supply									
Door(s)		2	2	2	2	2	2	2	
Door hinged on the right, may be swapped to the left		■	■	■	■	■	■	■	
Gland plate, size		6	6	6	6	6	6	7	
Gland plate, qty		2	2	2	2	2	2	2	
Cam lock		2	2	–	–	–	–	–	
3-point lock system		–	–	■	■	■	■	■	
Accessories									
Wall mounting bracket, for AX sheet steel, KX sheet steel, wall distance 20 mm	4 pc(s).	2508.020	2508.020	2508.020	2508.020	2508.020	2508.020	2508.020	966
Wall mounting bracket, for AX sheet steel, KX sheet steel, wall distance 40 mm	4 pc(s).	2503.020	2503.020	2503.020	2503.020	2503.020	2503.020	2503.020	966
Wall angle	4 pc(s).	2505.510	2505.510	2505.510	2505.510	2505.510	2505.510	2505.510	967
Pole clamp		–	–	–	–	–	–	–	
Plastic gland plate, modular	1 pc(s).	2566.200	2566.200	2566.200	2566.200	2566.200	2566.200	2567.200	1050
Plastic gland plate with membranes	1 pc(s).	2566.300	2566.300	2566.300	2566.300	2566.300	2566.300	2567.300	1052
Metal gland plate with knockouts	1 pc(s).	2576.100	2576.100	2576.100	2576.100	2576.100	2576.100	2577.100	1053
Sealing frame, modular		see page	see page	see page	see page	see page	see page	see page	1048
Rail for interior installation	4 pc(s).	2393.300	2393.300	2393.300	2393.400	2393.300	2393.400	2393.400	989
Support strips, installation in the door	20 pc(s).	4695.000	4695.000	–	–	–	–	–	952
Punched section with mounting flange 14 x 39 mm, installation in the height	4 pc(s).	8619.790	8619.750	8619.770	8619.770	8619.780	8619.780	8619.770	990
Punched section with mounting flange 14 x 39 mm, installation in the door ¹⁾	4 pc(s).	8619.710	8619.710	8619.710	8619.710	8619.710	8619.710	8619.720	952
LED system light	1 pc(s).	2500.110	2500.110	2500.110	2500.110	2500.110	2500.110	2500.110	1014
Mini-comfort handle AX for lock inserts or profile half-cylinders	1 pc(s).	2537.100	2537.100	–	–	–	–	–	940
Mini-comfort handle AX for padlock and lock inserts or profile half-cylinders	1 pc(s).	2537.300	2537.300	–	–	–	–	–	940
Comfort handle AX for lock inserts or profile half-cylinders	1 pc(s).	–	–	2435.100	2435.100	2435.100	2435.100	2435.100	939
Comfort handle AX for padlock and lock inserts or profile half-cylinders	1 pc(s).	–	–	2435.400	2435.400	2435.400	2435.400	2435.400	939
Lock inserts		see page	see page	see page	see page	see page	see page	see page	941, 942
Viewing window, depth 36 mm		–	–	–	–	–	–	–	
Viewing window, depth 62 mm		–	–	–	–	–	–	–	
Operating panel		–	–	–	–	–	–	–	
180° hinge	3 pc(s).	2449.010	2449.010	2449.010	2449.010	2449.010	2449.010	2449.010	951
Door stay	1 pc(s).	2519.010	2519.010	2519.010	2519.010	2519.010	2519.010	2519.010	956
Sheet steel wiring plan pockets, width-variable	1 pc(s).	2515.200	2515.200	2515.200	2515.200	2515.200	2515.200	2515.300	954
Plastic wiring plan pockets		see page	see page	see page	see page	see page	see page	see page	955
Wiring plan pockets with transparent pouch		see page	see page	see page	see page	see page	see page	see page	955
Base/plinth corner pieces with base/plinth trim panels, front and rear, 100 mm	2 pc(s).	2820.101	2820.101	2820.101	2820.101	2820.101	2820.101	2820.121	888
Base/plinth trim panels, sides, 100 mm	2 pc(s).	2820.310	2820.310	2820.310	2820.410	2820.310	2820.410	2820.410	889
Base/plinth corner pieces with base/plinth trim panels, front and rear, 200 mm	2 pc(s).	2820.102	2820.102	2820.102	2820.102	2820.102	2820.102	2820.122	888
Base/plinth trim panels, sides, 200 mm	2 pc(s).	2820.320	2820.320	2820.320	2820.420	2820.320	2820.420	2820.420	889
Eyebolts	2 pc(s).	–	2509.010	2509.010	2509.010	2509.010	2509.010	2509.010	964
Protective roof	1 pc(s).	2363.010	2363.010	2363.010	–	2363.010	–	–	958
Dust guard trim	1 pc(s).	2426.500	2426.500	2426.500	2426.500	2426.500	2426.500	2426.500	959
Earth straps		see page	see page	see page	see page	see page	see page	see page	1033
Baying kit	1 pc(s).	1199.100	1199.100	1199.100	1199.100	1199.100	1199.100	1199.100	916
Cable gland, brass		see page	see page	see page	see page	see page	see page	see page	1056
Cable gland, polyamide		see page	see page	see page	see page	see page	see page	see page	1056

¹⁾ For two-door enclosures: Installation in the lockable door

Plastic enclosures AX – Added durability





Enclosures

- 14 different enclosure variants, with or without viewing panel
- Symmetrical layout means the enclosure is easily rotated through 180°
- Double seal with an integral rain protection strip on the top and bottom edge of the door to protect the seal from dust and rainwater
- Fibreglass-reinforced plastic with a high level of UV resistance

Siting

- Wall mounting brackets are easily secured from the outside while retaining the UL approval
- The pole clamp may be screw-fastened directly into the external threaded inserts
- Ideally suited for outdoor applications

Mounting plate

- The mounting plate is easily screw-fastened onto the pre-assembled bolts from the front
- Simple earthing of the mounting plate, even retrospectively, using machined keyholes
- If no mounting plate is used, top hat rails may be mounted directly onto the available mounting bosses

Interior installation

- Numerous mounting bosses for individual interior installation
- Interior installation on a 25 mm pitch pattern with universal bracket for mounting punched sections and rails
- Direct door installation with support strips and punched sections with mounting flanges 14 x 39 mm, for use as an additional mounting surface
- Door-operated switches may be attached directly to the mounting bosses



Plastic enclosures AX



System accessories Page 877 Ex enclosures Page 257

Material:

- Enclosure and door: Fibreglass-reinforced unsaturated polyester
- Fire protection corresponding to UL 94 V-0
- Door: All-round foamed-in PU seal
- Mounting plate: Sheet steel

Surface finish:

- Enclosure and door: Dyed plastic with no after-treatment
- Mounting plate: Zinc-plated

Colour:

- Similar to RAL 7035

Protection class:

- II at 1000 V AC

Protection category IP to IEC 60 529:

- IP 66

Protection category NEMA:

- NEMA 4X

Supply includes:

- Enclosure with hinged door, of all-round solid construction, 3 mm double-bit lock
- Door hinged on the right, may be swapped to the left
- Mounting plate
- Twin seal on the top and bottom edges of the door as integral rain protection strip

Please note the product-specific scope of supply.

Note:

- Interior installation screws are required to secure components inside the enclosure
- Components such as punched sections with mounting flanges may be attached on a 25 mm pitch pattern using the universal bracket

Approvals:

- UL
- cUL

Further approvals can be found on the Internet.

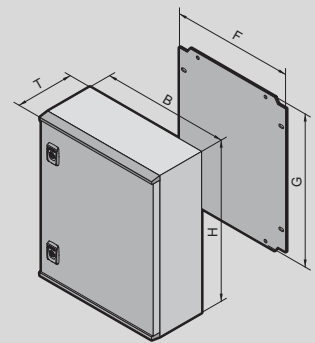

without viewing window

Width (B) mm	Packs of	250	300	400	400	500	600	600	800	Page
Height (H) mm		350	400	400	600	500	600	800	1000	
Depth (T) mm		150	200	200	200	300	200	300	300	
Mounting plate width (F) mm		155	205	305	305	405	505	505	705	
Mounting plate height (G) mm		275	325	325	525	425	525	725	925	
Mounting plate thickness mm		2.5	2.5	2.5	3.0	3.0	3.0	3.0	3.0	
Model No.	1 pc(s).	1432.000	1434.000	1444.000	1446.000	1453.000	1466.000	1468.000	1480.000	
Weight kg		4.4	6.3	7.8	11.1	13.1	15.5	22.4	34.2	
Product-specific scope of supply										
Cam lock		1	2	2	2	2	2	2	3	
Accessories										
Wall mounting bracket	4 pc(s).	1485.400	1485.400	1485.400	1485.400	1485.400	1485.400	1485.400	1485.400	97
Pole clamp	2 pc(s).	2584.100	2584.100	2584.100	2584.100	2584.100	2584.100	2584.100	–	968
Universal bracket	4 pc(s).	1485.200	1485.200	1485.200	1485.200	1485.200	1485.200	1485.200	1485.200	97
Door stay	2 pc(s).	1485.100	1485.100	1485.100	1485.100	1485.100	1485.100	1485.100	1485.100	96
LED system light		–	–	2500.100	2500.100	2500.100	2500.100	2500.110	2500.110	1014
Mini-comfort handle AX	1 pc(s).	1485.600	1485.600	1485.600	1485.600	1485.600	1485.600	1485.600	1485.600	96
Cable gland		see page	see page	see page	see page	see page	see page	see page	see page	1056
Screw for interior installation	50 pc(s).	1485.300	1485.300	1485.300	1485.300	1485.300	1485.300	1485.300	1485.300	97
Wiring plan pocket	1 pc(s).	–	–	–	–	–	4116.500	4116.500	4116.500	95
Punched section with mounting flange 23 x 64 mm, installation in the height	4 pc(s).	–	8617.110	8617.110	8617.130	8617.120	8617.130	8617.140	8617.150	991
Punched section with mounting flange 23 x 64 mm, installation in the width		–	–	8617.110	8617.110	8617.120	8617.130	8617.130	8617.140	
Support strips, installation in the door	20 pc(s).	–	–	4594.000	4594.000	4309.000	4596.000	4596.000	4598.000	952
Punched section with mounting flange 14 x 39 mm, installation in the door	4 pc(s).	–	–	8619.700	8619.700	8619.710	8619.720	8619.720	8619.730	952



System accessories Page 877 Ex enclosures Page 257

Material:

- Enclosure and door: Fibre-glass-reinforced unsaturated polyester
- Fire protection corresponding to UL 94 V-0
- Door: All-round foamed-in PU seal
- Mounting plate: Sheet steel
- Viewing window: Polycarbonate

Surface finish:

- Enclosure and door: Dyed plastic with no after-treatment
- Mounting plate: Zinc-plated

Colour:

- Similar to RAL 7035

Protection class:

- II at 1000 V AC

Protection category IP to IEC 60 529:

- IP 56

Protection category NEMA:

- NEMA 12

Supply includes:

- Enclosure with hinged door with viewing window, of all-round solid construction, 3 mm double-bit lock
- Door hinged on the right, may be swapped to the left
- Mounting plate
- Twin seal on the top and bottom edges of the door as integral rain protection strip

Please note the product-specific scope of supply.

Note:

- Interior installation screws are required to secure components inside the enclosure
- Components such as punched sections with mounting flanges may be attached on a 25 mm pitch pattern using the universal bracket

Approvals:

- UL
- cUL

Further approvals can be found on the Internet.

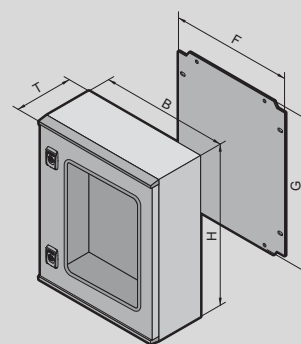

with viewing window

Width (B) mm	Packs of	400	400	500	600	600	800	Page
Height (H) mm		400	600	500	600	800	1000	
Depth (T) mm		200	200	300	200	300	300	
Mounting plate width (F) mm		305	305	405	505	505	705	
Mounting plate height (G) mm		325	525	425	525	725	925	
Mounting plate thickness mm		2.5	3.0	3.0	3.0	3.0	3.0	
Model No.	1 pc(s).	1448.000	1449.000	1454.000	1467.000	1469.000	1479.000	
Weight kg		7.7	10.9	12.9	15.2	21.9	33.2	
Product-specific scope of supply								
Cam lock		2	2	2	2	2	3	
Accessories								
Wall mounting bracket	4 pc(s).	1485.400	1485.400	1485.400	1485.400	1485.400	1485.400	97
Pole clamp	2 pc(s).	2584.100	2584.100	2584.100	2584.100	2584.100	-	968
Universal bracket	4 pc(s).	1485.200	1485.200	1485.200	1485.200	1485.200	1485.200	97
Door stay	2 pc(s).	1485.100	1485.100	1485.100	1485.100	1485.100	1485.100	96
LED system light		2500.100	2500.100	2500.100	2500.100	2500.110	2500.110	1014
Mini-comfort handle AX	1 pc(s).	1485.600	1485.600	1485.600	1485.600	1485.600	1485.600	96
Cable gland		see page	see page	see page	see page	see page	see page	1056
Screw for interior installation	50 pc(s).	1485.300	1485.300	1485.300	1485.300	1485.300	1485.300	97
Wiring plan pocket	1 pc(s).	-	-	-	4116.500	4116.500	4116.500	955
Punched section with mounting flange 23 x 64 mm, installation in the height	4 pc(s).	8617.110	8617.130	8617.120	8617.130	8617.140	8617.150	991
Punched section with mounting flange 23 x 64 mm, installation in the width		8617.110	8617.110	8617.120	8617.130	8617.130	8617.140	
Support strips, installation in the door	20 pc(s).	4594.000	4594.000	4309.000	4596.000	4596.000	4598.000	952
Punched section with mounting flange 14 x 39 mm, installation in the door	4 pc(s).	8619.700	8619.700	8619.710	8619.720	8619.720	8619.730	952

Plastic enclosures AX

Accessories

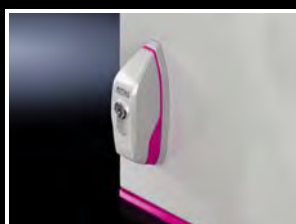

Mini-comfort handle AX

for AX plastic

The unlatched handle swivels to open the lock. Prepared for the installation of lock inserts or for the installation of standard commercially available 40 or 45 mm profile half-cylinders, as well as lock and push-button inserts.

Packs of	Model No.
1 pc(s).	1485.600
Lock inserts, type A	
7 mm square	2460.000
8 mm square	2461.000
7 mm triangular	2462.000
8 mm triangular	2463.000
Screwdriver	2464.000
Daimler insert	2465.000
3 mm double-bit	2466.000
Fiat	2307.000
6.5 mm triangular	2460.650
Lock and push-button inserts	
Lock insert, lock no. 3524 E ¹⁾	2467.000
Push-button insert	2468.000
Push-button and lock insert ¹⁾	2469.000 ²⁾
Profile half-cylinders	
To DIN 18 252 ³⁾	9785.040 ⁵⁾
	9785.042 ⁴⁾

¹⁾ With 2 keys

²⁾ Lock no. 2123; no other lock is possible

³⁾ With 3 keys for each lock insert

⁴⁾ Packs of two, simultaneous locking within the same pack, no simultaneous locking for different packs

⁵⁾ Lock-specific key



Door stay AX

for AX plastic and Ex enclosure, plastic

To secure the door in the open position. May be fitted without machining the enclosure.

Supply includes:

- Assembly parts

Installation options:

- Installation directly at the top/bottom right
- When swapping the door hinge to the opposite side, the prefitted door stay is easily removed and re-installed

Assembly	Packs of	Model No.
Top/bottom	2 pc(s).	1485.100

Plastic enclosures AX

Accessories

Wall mounting bracket

for AX plastic

For attachment to the wall, only possible from the outside of the enclosure.

Material:

- Fibreglass-reinforced polyamide¹⁾

Supply includes:

- Assembly parts for mounting on the enclosure

Colour	Packs of	Model No.
RAL 7035	4 pc(s).	1485.400
RAL 9011	4 pc(s).	1485.500¹⁾

¹⁾ With graphite additive for Ex applications

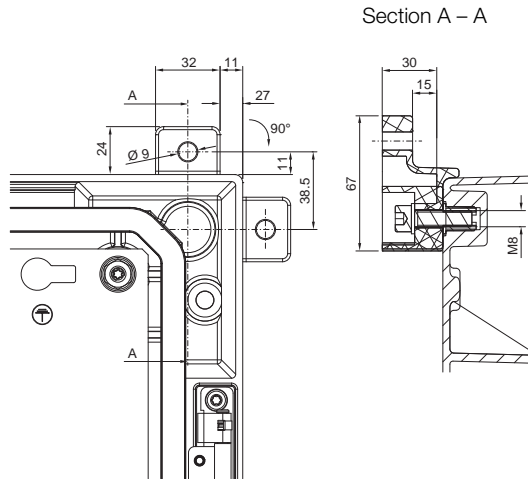

Universal bracket

for AX plastic and Ex enclosure, plastic

For the interior installation on a 25 mm pitch pattern of

- Punched sections with mounting flanges
- Door rails
- Support strips

Material:

- Sheet steel, zinc-plated

Supply includes:

- Assembly parts

Packs of	Model No.
4 pc(s).	1485.200



Screw for interior installation

for AX plastic

For mounting accessories on the mounting bosses of the enclosure frame.

Drive: Multi-tooth 25

Dimensions: 5 x 14 mm

Type of screw	Packs of	Model No.
Pan head screw, self-tapping	50 pc(s).	1485.300



Rittal – The System.

Faster – better – everywhere.



Rack systems



Baying enclosure system VX25

Product comparison	102
Product overview	104
Product advantages	106
Basic enclosure, height 1200 mm, depth 500 mm	117
Basic enclosure, height 1400 mm, depth 500 mm	118
Basic enclosure, height 1600 mm, depth 500 mm	119
Basic enclosure, height 1800 mm, depth 400 mm	120
Basic enclosure, height 1800 mm, depth 500 mm	121
Basic enclosure, height 1800 mm, depth 600 mm	122
Basic enclosure, height 2000 mm, depth 400 mm	123
Basic enclosure, height 2000 mm, depth 500 mm	124
Basic enclosure, height 2000 mm, depth 600 mm	125
Basic enclosure, height 2000 mm, depth 800 mm	126
Basic enclosure, height 2200 mm, depth 600 mm	127
Basic enclosure with glazed door	129
Electronic enclosures	130
IP 66/NEMA 4	131
Modular enclosures, height 2000 mm	132
Modular enclosures, height 2200 mm	133
Fuse-switch-disconnector enclosures	134
Distribution enclosures	135
EMC enclosures	136

Free-standing enclosure system VX SE

Product advantages	138
Basic enclosure, width 600 mm	143
Basic enclosure, width 800 mm	144
Basic enclosure, width 1000 – 1200 mm	145
Basic enclosure, width 1600 – 1800 mm	146
IP 66/NEMA 4	147



Two powerful models – one accessory range – one system

Free-standing enclosure system VX SE

For standalone enclosure applications up to 1800 mm wide



Baying enclosure system VX25

For individual bayed combinations – accessible from all sides



Baying enclosure system VX25 – Product comparison



		Basic enclosure		Basic enclosure with glazed door	Electronic enclosure	IP 66/NEMA 4	
Material	Sheet steel	■	–	■	■	■	
	Stainless steel	–	■	–	–	–	
Cladding	Door, front	■	■	–	–	■	
	Glazed door, front	–	–	■	–	–	
	Front frame	–	–	–	■	–	
	Front trim panels	–	–	–	–	–	
	Door, rear	–	–	■	■	–	
	Rear panel	■	■	–	–	■	
	Roof plate	■	■	■	■	■	
Interior installation	Mounting plate	■	■	–	■	■	
	Punched rails	■	■	–	–	■	
	Gland plate, solid	–	–	–	–	■	
	Gland plate, multi-piece	■	■	■	■	–	
	Locating frame for fuse-switch disconnectors	–	–	–	–	–	
	Adaptor section, 482.6 mm (19"), front	–	–	–	■	–	
Protection category	IP to IEC 60 529	IP 55	IP 55	IP 55	–	IP 66	
	NEMA	12	12	12	–	4	
from page		116	242	128	130	131	

Baying enclosure system VX25 – Product comparison



Enclosures

	IP 66/NEMA 4X	Distribution enclosure	Modular enclosure	Fuse-switch-disconnector enclosure	EMC enclosure
	–	■	■	■	■ ¹⁾
	■	–	–	–	–
	■	■	–	■	■
	–	–	–	–	–
	–	–	–	–	–
	–	–	–	■	–
	–	–	–	–	–
	■	■	■	■	■
	■	■	–	■	■
	■	–	–	–	■
	■	–	–	–	■
	■	–	–	–	–
	–	■	■	■	■
	–	–	–	■	–
	–	–	–	–	–
	IP 66	IP 55	Up to IP 54 ²⁾	Up to IP 3X ²⁾	IP 55
	4X	12	–	–	12
	246	135	132	134	136

¹⁾ Sheet steel with magnesium zinc coating ²⁾ Depending on the cladding

Baying enclosure system VX25 – Product overview



			Basic enclosure		Basic enclosure with glazed door ¹⁾	Electronic enclosure ²⁾	IP 66/NEMA 4	
Height x depth mm	Width mm	Doors	Model No.	Model No.	Model No.	Model No.	Model No.	
			Sheet steel	Stainless steel	Sheet steel	Sheet steel	Sheet steel	
1200 x 500	600	1	8615.000	-	-	-	-	-
	800	1	8815.000	-	-	-	-	-
	1200	2	8215.000	-	-	-	-	-
1400 x 500	600	1	8645.000	-	-	-	-	-
	800	1	8845.000	-	-	-	-	-
	1200	2	8245.000	-	-	-	-	-
1600 x 500	600	1	8665.000	-	-	-	-	-
	800	1	8865.000	-	-	-	-	-
	1200	2	8265.000	-	-	-	-	-
1600 x 600	600	1	-	-	-	8410.000	-	
1600 x 800	600	1	-	-	-	8418.000	-	
1800 x 400	600	1	8684.000	-	-	-	-	-
	800	1	8884.000	8454.000	-	-	-	-
	1000	1	8084.000	-	-	-	-	-
	1000	2	8080.000	-	-	-	-	-
	1200	2	8284.000	8456.000	-	-	-	-
1800 x 500	400	1	8485.000	-	-	-	-	-
	600	1	8685.000	8457.000	-	-	-	-
	800	1	8885.000	8455.000	-	-	-	-
	800	2	8880.000	-	-	-	-	-
	1200	2	8285.000	8453.000	-	-	-	-
1800 x 600	400	1	8486.000	-	-	-	-	-
	600	1	8686.000	-	-	-	-	-
	800	1	8886.000	-	-	-	-	-
	800	2	8881.000	-	-	-	-	-
	1200	2	8286.000	-	-	-	-	-
2000 x 400	400	1	-	-	-	-	-	-
	600	1	8604.000	-	-	-	-	-
	800	1	8804.000	-	-	-	-	-
	850	1	-	-	-	-	-	-
	1000	2	8004.000	-	-	-	-	-
	1100	2	-	-	-	-	-	-
	1200	2	8204.000	-	-	-	-	-
2000 x 500	400	1	8405.000	-	-	-	-	-
	600	1	8605.000	-	-	-	-	-
	800	1	8805.000	-	-	-	-	-
	1000	2	8005.000	-	-	-	-	-
	1200	2	8205.000	-	-	-	-	-
2000 x 600	400	1	8406.000	-	-	-	-	-
	600	1	8606.000	8452.000	8840.120	8430.000	-	
	800	1	8806.000	8450.000	8840.100	-	8807.000	
	850	1	-	-	-	-	-	
	1000	2	8006.000	-	-	-	-	
	1100	2	-	-	-	-	-	
	1200	2	8206.000	8451.000	-	-	-	
2000 x 800	400	1	-	-	-	-	-	
	600	1	8608.000	-	8840.130	8438.000	-	
	800	1	8808.000	-	8840.110	-	-	
2200 x 600	1200	2	8208.000	-	-	-	-	
	400	1	-	-	-	-	-	
	600	1	8626.000	-	-	-	-	
	800	1	8826.000	-	-	-	-	
	1000	1	-	-	-	-	-	
2200 x 800	1200	2	8226.000	-	-	-	-	
	400	1	-	-	-	-	-	
	600	1	-	-	-	-	-	
	800	1	-	-	-	-	-	
	1200	1	-	-	-	-	-	

¹⁾ Glazed door at the front, rear door ²⁾ Rear door

Baying enclosure system VX25 – Product overview



			IP 66/NEMA 4X	Distribution enclosure	Modular enclosure ³⁾	Fuse-switch-disconnector enclosure	EMC enclosure	
	Width mm	Doors	Model No.	Model No.	Model No.	Model No.	Model No.	
			Stainless steel	Sheet steel	Sheet steel	Sheet steel	Sheet steel ⁴⁾	
	600	1	-	-	-	-	-	
	800	1	-	-	-	-	-	
	1200	2	-	-	-	-	-	
	600	1	-	-	-	-	-	
	800	1	-	-	-	-	-	
	1200	2	-	-	-	-	-	
	600	1	-	-	-	-	-	
	800	1	-	-	-	-	-	
	1200	2	-	-	-	-	-	
	600	1	-	-	-	-	-	
	600	1	-	-	-	-	-	
	600	1	-	-	-	-	-	
	800	1	-	-	-	-	-	
	1000	1	-	-	-	-	-	
	1000	2	-	-	-	-	-	
	1200	2	-	-	-	-	-	
	400	1	-	-	-	-	-	
	600	1	-	-	-	-	-	
	800	1	-	-	-	-	-	
	800	2	-	-	-	-	-	
	1200	2	-	-	-	-	-	
	400	1	-	-	-	-	-	
	600	1	-	-	-	-	-	
	800	1	-	-	-	-	-	
	800	2	-	-	-	-	-	
	1200	2	-	-	-	-	-	
	400	1	-	-	-	-	-	
	600	1	-	-	-	-	-	
	800	1	-	-	-	-	-	
	800	2	-	-	-	-	-	
	1200	2	-	-	-	-	-	
	400	1	-	-	-	-	-	
	600	1	-	-	-	-	-	
	800	1	-	-	-	-	-	
	800	2	-	-	-	-	-	
	1200	2	-	-	-	-	-	
	400	1	-	-	-	-	-	
	600	1	-	-	-	-	-	
	800	1	-	-	-	-	-	
	850	1	-	9666.956	-	-	-	
	1000	2	-	-	-	-	-	
	1100	2	-	9666.966	-	-	-	
	1200	2	-	-	-	-	-	
	400	1	-	-	-	-	-	
	600	1	-	-	-	-	-	
	800	1	-	-	-	-	-	
	1000	2	-	-	-	-	-	
	1200	2	-	-	-	-	-	
	400	1	-	-	9680.406	-	-	
	600	1	-	-	9680.606	-	-	
	800	1	8458.000	-	9680.806	-	8807.010	
	850	1	-	9666.916	-	-	-	
	1000	1	-	-	-	9680.005	-	
	1100	2	-	9666.926	-	-	-	
	1200	2	-	-	-	-	-	
	400	1	-	-	9680.408	-	-	
	600	1	-	-	9680.608	-	-	
	800	1	-	-	9680.808	-	8807.020	
	1200	1	-	-	-	9680.207	-	
	400	1	-	-	9680.426	-	-	
	600	1	-	-	9680.626	-	-	
	800	1	-	-	9680.826	-	-	
	1000	1	-	-	-	9680.025	-	
	1200	2	-	-	-	-	-	
	400	1	-	-	9680.428	-	-	
	600	1	-	-	9680.628	-	-	
	800	1	-	-	9680.828	-	-	
	1200	1	-	-	-	9680.227	-	
			246	135	132	134	136	

³⁾ Without door ⁴⁾ Sheet steel with magnesium zinc coating

Baying enclosure system VX25 – Added system benefits

System benefits – Rittal's standards (not to be taken for granted)
create additional cross-system benefits



Digitalization

- The QR code on all machinable enclosure panels permits fully automated incorporation into the production workflow, for seamless digital monitoring from the incoming goods right through to the finished product.



Material savings

- As standard, potential equalisation of the enclosure panels occurs during screw-fastening, which saves up to seven earth straps per enclosure and also improves work safety by eliminating sharp-edged protruding parts.



System

- Automatic potential equalisation of the roof, rear panel and sides acts as earthing when Rittal climate control devices and Rittal fan-and-filter units are installed.



Reliable engineering

- Rittal's customers are supported by a wealth of conversion and planning tools in the automated production process and when working with a virtual prototype:
 - Configurators
 - Parts list converters
 - EPLAN Pro Panel
 - 2D/3D CAD data
 - ecl@ss Advanced
 - Technical documentation
 - Data for planners
 - Assembly videos

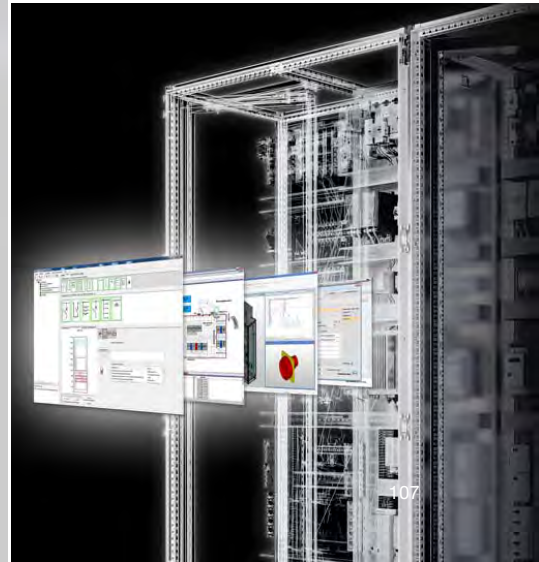

Baying enclosure system VX25 – Added system benefits

Frame and punched sections – Now with added assembly-friendliness plus efficient engineering thanks to a symmetrical frame section on a 25 mm pitch pattern across all levels, accessible from all sides.



Accessibility

- The system offers an outer mounting level in addition to the inner level, making the enclosure readily accessible and configurable from the outside.

Installation options

- The continuous pattern of square punchings supports the use of M5/M6/M8 cage nuts to create more mounting options at all profile levels.

Stability

- The corner piece with welded base frame makes it easier to secure to the floor and base and improves stability.
- The enclosure is secured to the base/plinth or subsurface either via the M12 thread in the corner piece or via the stable base structure.

Simple cable entry

- The blunt edges minimise the risk of cable damage when routing cables underneath the enclosure.
- The earthing points pre-labelled as standard provide quick guidance and help to speed up the work process.
- The double edge fold of the gland plates is resistant to bending even under heavy loads to ensure compliance with the high protection category.

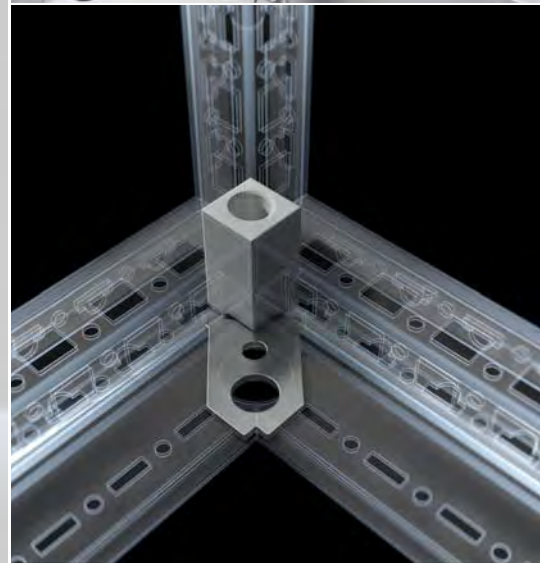

Baying enclosure system VX25 – Added time savings

Doors and walls – More flexible, assembly-friendly and economical, thanks to an ingenious hinge system, a quick-fit and readily replaceable lock system, and the elimination of avoidable machining processes.



Making life easier

- The new hinge allows doors to be fitted and removed incredibly easily without any tools, and separately locking and unlocking the hinge bolts is a thing of the past.

Handling

- For one-man assembly, the positioning aid for the side and rear panels allows labour-saving pre-fixing for the ideal fit, which you can screw-fasten later on when you have both hands free.

Flexibility

- Because the hinges of the main and adjacent doors in two-door enclosures can be swapped to the opposite side if required, this creates greater flexibility when installing cooling units in the enclosure doors and helps to avoid collisions between equipment and doors.

Time savings

- The tool-free, readily exchangeable lock systems, e.g. on the comfort handle, reduce the amount of assembly time required.



Baying enclosure system VX25 – Added reductions in complexity

Baying – Complexity is further reduced thanks to a simplified, more consistent baying system for all applications.



Overview

- The baying connectors have been designed to cover every potential baying scenario in enclosure production with just a few baying solutions. This allows easier decision-making and relieves the pressure on engineering.

Location flexibility

- The option of baying from all four sides allows an individual response to every space situation.

Clamping force

- The baying connectors are screwed into place in the direction of baying to bring the enclosures safely into position and are approved for transportation.

Sealing efficiency

- The seal, which can be inserted in a flash, allows precise positioning and can be removed at any time.



Enclosures

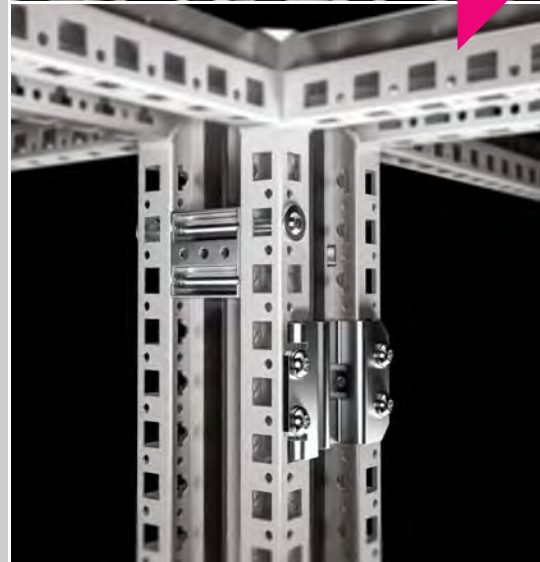

Baying enclosure system VX25 – Added assembly-friendliness

Mounting plate – More time gains, installation options and assembly-friendliness thanks to improved mounting kits, also suitable for dynamic loads.



Space gain

- The option of fitting the mounting plate 20 mm deeper in the enclosure with a special installation kit creates additional space in the enclosure depth.

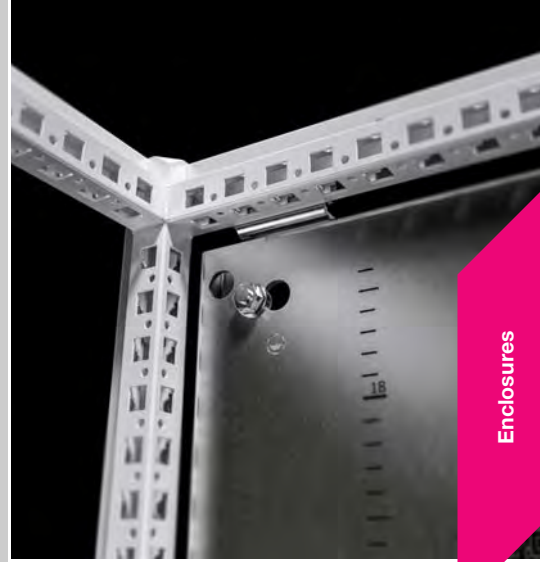

Process efficiency

- The integral clip means that the mounting plate slide block can be dismantled with no need for tools and easily refitted. This helps to streamline the fully automated machining process in every respect.



Flexibility

- The system divider designed for installation in the enclosure depth divides wide enclosures into two halves, increasing the flexibility of interior installation.



Additional benefits

- The practical mounting plate slide rail can be removed once the mounting plate has been inserted and used elsewhere in the enclosure as a fully functional punched section.
- The grid print facilitates the simple, fast positioning of components on the mounting plate.

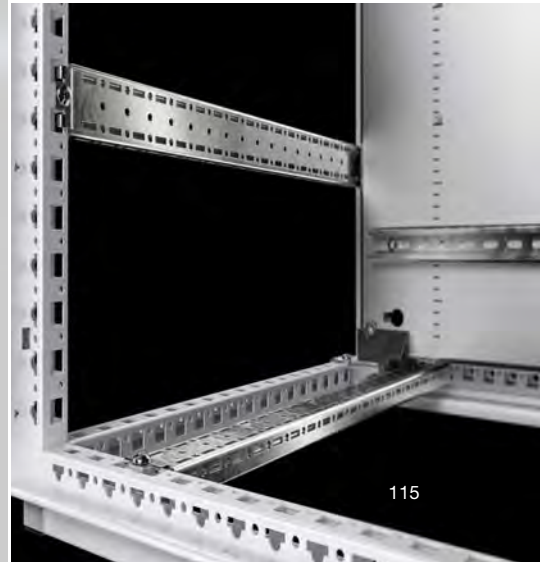

Baying enclosure system VX25



System accessories Page 877 VX25 basic enclosure with glazed door Page 128 VX25 stainless steel Page 242 VX25 EMC-shielded Page 136

Material and surface finish:

- Enclosure frame: Sheet steel, 1.5 mm, dipcoat-primed
- Roof: Sheet steel, 1.5 mm, dipcoat-primed, powder-coated on the outside, textured paint
- Door: Sheet steel, 2 mm, dipcoat-primed, powder-coated on the outside, textured paint
- Rear panel: Sheet steel, 1.5 mm, dipcoat-primed, powder-coated on the outside, textured paint
- Gland plates: Sheet steel, 1.5 mm, zinc-plated, passivated
- Mounting plate: Sheet steel, 3 mm, zinc-plated, passivated

Colour:

- RAL 7035

Protection category IP to IEC 60 529:

- IP 55

Protection category NEMA:

- NEMA 12

Supply includes:

- Enclosure frame
- Door(s) (r/h hinge, may be swapped to opposite side)
- Roof plate
- Rear panel
- Gland plates
- Mounting plate
- 2 punched rails 18 x 39 mm
- Lock: 3 mm double-bit

Approvals:

- UL
 - cUL
 - DNV-GL
 - Lloyds Register of Shipping
- Further approvals can be found on the Internet.

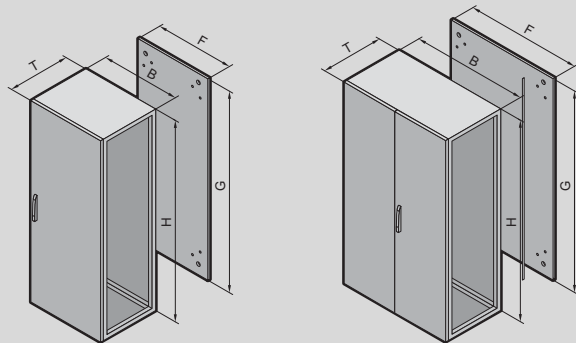

Baying enclosure system VX25

Basic enclosure, height 1200 mm, depth 500 mm

Width (B) mm	Packs of	600	800	1200	Page
Height (H) mm		1200	1200	1200	
Depth (T) mm		500	500	500	
Mounting plate width (F) mm		499	699	1099	
Mounting plate height (G) mm		1096	1096	1096	
Model No.	1 pc(s).	8615.000	8815.000	8215.000	
Weight kg		66.0	82.4	126.0	
Product-specific scope of supply					
Door(s)		1	1	2	
Accessories					
Base/plinth corner pieces with base/plinth trim panels, front and rear, 100 mm	2 pc(s).	8640.002	8640.003	8640.007	881
Base/plinth trim panels, sides, 100 mm	2 pc(s).	8640.032	8640.032	8640.032	882
Base/plinth corner pieces with base/plinth trim panels, front and rear, 200 mm	2 pc(s).	8640.022	8640.023	8640.025	881
Base/plinth trim panels, sides, 200 mm	2 pc(s).	8640.042	8640.042	8640.042	882
Levelling feet	4 pc(s).	4612.000	4612.000	4612.000	892
Side panels, screw-fastened, sheet steel	2 pc(s).	8115.245	8115.245	8115.245	901
Divider panel		-	-	-	
Divider panel for module plates		-	-	-	
Baying bracket, internal	6 pc(s).	8617.500	8617.500	8617.500	912
Baying block, internal	6 pc(s).	8617.501	8617.501	8617.501	912
Baying connector, external	6 pc(s).	8617.502	8617.502	8617.502	912
Glazed door	1 pc(s).	-	-	-	
Comfort handle VX for lock inserts	1 pc(s).	8618.200	8618.200	8618.200	937
Comfort handle VX for lock inserts and padlock	1 pc(s).	8618.230	8618.230	8618.230	937
Comfort handle VX for profile half-cylinders	1 pc(s).	8618.250	8618.250	8618.250	937
Comfort handle VX with security lock insert, lock E1	1 pc(s).	8618.240	8618.240	8618.240	937
Comfort handle VX for ASSA lock system	1 pc(s).	8618.270	8618.270	8618.270	937
Lock inserts		see page	see page	see page	941, 942
180° hinges	4 pc(s).	8618.330	8618.330	8618.330	951
Punched section with mounting flange, 14 x 39 mm, for tubular door frame	4 pc(s).	8619.720	8619.730	8619.720	952
Wiring plan pocket, sheet steel, depth 35 mm	1 pc(s).	4116.500	4118.500	4116.500	955
Wiring plan pocket, sheet steel, depth 90 mm	1 pc(s).	4116.000	4118.000	4116.000	955
Door stay	1 pc(s).	8618.430	8618.430	8618.430	956
Door stay for escape routes	1 pc(s).	8618.425	8618.425	8618.425	956
Ride-up roller	10 pc(s).	8618.420	8618.420	8618.420	956
Mounting plate infill		-	-	-	
Punched section with mounting flange 18 x 64 mm for the outer level, in the width	4 pc(s).	8617.030	8617.040	8617.060	990
Punched section with mounting flange 18 x 64 mm for the outer level, in the depth	4 pc(s).	8617.020	8617.020	8617.020	990
Punched section with mounting flange 23 x 64 mm for the inner level, in the width	4 pc(s).	8617.130	8617.140	8617.160	991
Punched section with mounting flange 23 x 64 mm for the inner level, in the depth	4 pc(s).	8617.120	8617.120	8617.120	991
Punched rail 18 x 39 mm for the enclosure depth	4 pc(s).	8617.710	8617.710	8617.710	993
Support strip for the enclosure depth	20 pc(s).	4695.000	4695.000	4695.000	994
C rail 30/15, for the enclosure width	6 pc(s).	4944.000	4945.000	4947.000	996
Support rail 48 x 26 mm, for the enclosure width	2 pc(s).	8617.800	8617.810	8617.830	996
LED system light		see page	see page	see page	1014
Earth straps		see page	see page	see page	1033
		8619.800	8619.801	8619.803	1044
Cable entry plates					
	Packs of	2 pc(s).	2 pc(s).	4 pc(s).	
Cable entry grommets	8 cables, max. Ø 13 mm	25 pc(s).	4316.000	4316.000	4316.000
	3 cables, max. Ø 21 mm	25 pc(s).	4317.000	4317.000	4317.000
	1 cable, max. Ø 47 mm	25 pc(s).	4318.000	4318.000	4318.000
Connector grommets	10 pc(s).	4311.000	4311.000	4311.000	1044
Section for cable entry, centre		8618.800	8618.801	8618.803	1045
	Packs of	2 pc(s).	2 pc(s).	4 pc(s).	
Section for cable entry, rear		8618.810	8618.811	8618.813	1045
	Packs of	2 pc(s).	2 pc(s).	4 pc(s).	
Cable duct		see page	see page	see page	1058
Cable clamp rail, right angle section	2 pc(s).	8619.410	8619.420	8619.440	1059

Baying enclosure system VX25

Basic enclosure, height 1400 mm, depth 500 mm

Width (B) mm	Packs of	600	800	1200	Page
Height (H) mm		1400	1400	1400	
Depth (T) mm		500	500	500	
Mounting plate width (F) mm		499	699	1099	
Mounting plate height (G) mm		1296	1296	1296	
Model No.	1 pc(s).	8645.000	8845.000	8245.000	
Weight kg		73.8	92.2	141.0	
Product-specific scope of supply					
Door(s)		1	1	2	
Accessories					
Base/plinth corner pieces with base/plinth trim panels, front and rear, 100 mm	2 pc(s).	8640.002	8640.003	8640.007	881
Base/plinth trim panels, sides, 100 mm	2 pc(s).	8640.032	8640.032	8640.032	882
Base/plinth corner pieces with base/plinth trim panels, front and rear, 200 mm	2 pc(s).	8640.022	8640.023	8640.025	881
Base/plinth trim panels, sides, 200 mm	2 pc(s).	8640.042	8640.042	8640.042	882
Levelling feet	4 pc(s).	4612.000	4612.000	4612.000	892
Side panels, screw-fastened, sheet steel	2 pc(s).	8145.245	8145.245	8145.245	901
Divider panel		-	-	-	
Divider panel for module plates		-	-	-	
Baying bracket, internal	6 pc(s).	8617.500	8617.500	8617.500	912
Baying block, internal	6 pc(s).	8617.501	8617.501	8617.501	912
Baying connector, external	6 pc(s).	8617.502	8617.502	8617.502	912
Glazed door		-	-	-	
Comfort handle VX for lock inserts	1 pc(s).	8618.200	8618.200	8618.200	937
Comfort handle VX for lock inserts and padlock	1 pc(s).	8618.230	8618.230	8618.230	937
Comfort handle VX for profile half-cylinders	1 pc(s).	8618.250	8618.250	8618.250	937
Comfort handle VX with security lock insert, lock E1	1 pc(s).	8618.240	8618.240	8618.240	937
Comfort handle VX for ASSA lock system	1 pc(s).	8618.270	8618.270	8618.270	937
Lock inserts		see page	see page	see page	941, 942
180° hinges	4 pc(s).	8618.330	8618.330	8618.330	951
Punched section with mounting flange, 14 x 39 mm, for tubular door frame	4 pc(s).	8619.720	8619.730	8619.720	952
Wiring plan pocket, sheet steel, depth 35 mm	1 pc(s).	4116.500	4118.500	4116.500	955
Wiring plan pocket, sheet steel, depth 90 mm	1 pc(s).	4116.000	4118.000	4116.000	955
Door stay	1 pc(s).	8618.430	8618.430	8618.430	956
Door stay for escape routes	1 pc(s).	8618.425	8618.425	8618.425	956
Ride-up roller	10 pc(s).	8618.420	8618.420	8618.420	956
Mounting plate infill		-	-	-	
Punched section with mounting flange 18 x 64 mm for the outer level, in the width	4 pc(s).	8617.030	8617.040	8617.060	990
Punched section with mounting flange 18 x 64 mm for the outer level, in the depth	4 pc(s).	8617.020	8617.020	8617.020	990
Punched section with mounting flange 23 x 64 mm for the inner level, in the width	4 pc(s).	8617.130	8617.140	8617.160	991
Punched section with mounting flange 23 x 64 mm for the inner level, in the depth	4 pc(s).	8617.120	8617.120	8617.120	991
Punched rail 18 x 39 mm for the enclosure depth	4 pc(s).	8617.710	8617.710	8617.710	993
Support strip for the enclosure depth	20 pc(s).	4695.000	4695.000	4695.000	994
C rail 30/15, for the enclosure width	6 pc(s).	4944.000	4945.000	4947.000	996
Support rail 48 x 26 mm, for the enclosure width	2 pc(s).	8617.800	8617.810	8617.830	996
LED system light		see page	see page	see page	1014
Earth straps		see page	see page	see page	1033
		8619.800	8619.801	8619.803	1044
Cable entry plates					
	Packs of	2 pc(s).	2 pc(s).	4 pc(s).	
Cable entry grommets	8 cables, max. Ø 13 mm	25 pc(s).	4316.000	4316.000	4316.000
	3 cables, max. Ø 21 mm	25 pc(s).	4317.000	4317.000	4317.000
	1 cable, max. Ø 47 mm	25 pc(s).	4318.000	4318.000	4318.000
Connector grommets	10 pc(s).	4311.000	4311.000	4311.000	1044
Section for cable entry, centre		8618.800	8618.801	8618.803	1045
	Packs of	2 pc(s).	2 pc(s).	4 pc(s).	
Section for cable entry, rear		8618.810	8618.811	8618.813	1045
	Packs of	2 pc(s).	2 pc(s).	4 pc(s).	
Cable duct		see page	see page	see page	1058
Cable clamp rail, right angle section	2 pc(s).	8619.410	8619.420	8619.440	1059

Baying enclosure system VX25

Basic enclosure, height 1600 mm, depth 500 mm

Width (B) mm	Packs of	600	800	1200	Page
Height (H) mm		1600	1600	1600	
Depth (T) mm		500	500	500	
Mounting plate width (F) mm		499	699	1099	
Mounting plate height (G) mm		1496	1496	1496	
Model No.	1 pc(s).	8665.000	8865.000	8265.000	
Weight kg		81.9	102.0	156.0	
Product-specific scope of supply					
Door(s)		1	1	2	
Accessories					
Base/plinth corner pieces with base/plinth trim panels, front and rear, 100 mm	2 pc(s).	8640.002	8640.003	8640.007	881
Base/plinth trim panels, sides, 100 mm	2 pc(s).	8640.032	8640.032	8640.032	882
Base/plinth corner pieces with base/plinth trim panels, front and rear, 200 mm	2 pc(s).	8640.022	8640.023	8640.025	881
Base/plinth trim panels, sides, 200 mm	2 pc(s).	8640.042	8640.042	8640.042	882
Levelling feet	4 pc(s).	4612.000	4612.000	4612.000	892
Side panels, screw-fastened, sheet steel	2 pc(s).	8165.245	8165.245	8165.245	901
Divider panel		-	-	-	
Divider panel for module plates		-	-	-	
Baying bracket, internal	6 pc(s).	8617.500	8617.500	8617.500	912
Baying block, internal	6 pc(s).	8617.501	8617.501	8617.501	912
Baying connector, external	6 pc(s).	8617.502	8617.502	8617.502	912
Glazed door		-	-	-	
Comfort handle VX for lock inserts	1 pc(s).	8618.200	8618.200	8618.200	937
Comfort handle VX for lock inserts and padlock	1 pc(s).	8618.230	8618.230	8618.230	937
Comfort handle VX for profile half-cylinders	1 pc(s).	8618.250	8618.250	8618.250	937
Comfort handle VX with security lock insert, lock E1	1 pc(s).	8618.240	8618.240	8618.240	937
Comfort handle VX for ASSA lock system	1 pc(s).	8618.270	8618.270	8618.270	937
Lock inserts		see page	see page	see page	941, 942
180° hinges	4 pc(s).	8618.330	8618.330	8618.330	951
Punched section with mounting flange, 14 x 39 mm, for tubular door frame	4 pc(s).	8619.720	8619.730	8619.720	952
Wiring plan pocket, sheet steel, depth 35 mm	1 pc(s).	4116.500	4118.500	4116.500	955
Wiring plan pocket, sheet steel, depth 90 mm	1 pc(s).	4116.000	4118.000	4116.000	955
Door stay	1 pc(s).	8618.430	8618.430	8618.430	956
Door stay for escape routes	1 pc(s).	8618.425	8618.425	8618.425	956
Ride-up roller	10 pc(s).	8618.420	8618.420	8618.420	956
Mounting plate infill		-	-	-	
Punched section with mounting flange 18 x 64 mm for the outer level, in the width	4 pc(s).	8617.030	8617.040	8617.060	990
Punched section with mounting flange 18 x 64 mm for the outer level, in the depth	4 pc(s).	8617.020	8617.020	8617.020	990
Punched section with mounting flange 23 x 64 mm for the inner level, in the width	4 pc(s).	8617.130	8617.140	8617.160	991
Punched section with mounting flange 23 x 64 mm for the inner level, in the depth	4 pc(s).	8617.120	8617.120	8617.120	991
Punched rail 18 x 39 mm for the enclosure depth	4 pc(s).	8617.710	8617.710	8617.710	993
Support strip for the enclosure depth	20 pc(s).	4695.000	4695.000	4695.000	994
C rail 30/15, for the enclosure width	6 pc(s).	4944.000	4945.000	4947.000	996
Support rail 48 x 26 mm, for the enclosure width	2 pc(s).	8617.800	8617.810	8617.830	996
LED system light		see page	see page	see page	1014
Earth straps		see page	see page	see page	1033
Cable entry plates		8619.800	8619.801	8619.803	1044
Cable entry grommets	Packs of	2 pc(s).	2 pc(s).	4 pc(s).	
	8 cables, max. Ø 13 mm	25 pc(s).	4316.000	4316.000	1044
	3 cables, max. Ø 21 mm	25 pc(s).	4317.000	4317.000	1044
Connector grommets	1 cable, max. Ø 47 mm	25 pc(s).	4318.000	4318.000	1044
Section for cable entry, centre	10 pc(s).	4311.000	4311.000	4311.000	1044
Section for cable entry, rear		8618.800	8618.801	8618.803	1045
	Packs of	2 pc(s).	2 pc(s).	4 pc(s).	
Cable duct		8618.810	8618.811	8618.813	1045
Cable clamp rail, right angle section		2 pc(s).	2 pc(s).	4 pc(s).	
		see page	see page	see page	1058
	2 pc(s).	8619.410	8619.420	8619.440	1059

Baying enclosure system VX25

Basic enclosure, height 1800 mm, depth 400 mm

Width (B) mm	Packs of	600	800	1000	1000	1200	Page
Height (H) mm		1800	1800	1800	1800	1800	
Depth (T) mm		400	400	400	400	400	
Mounting plate width (F) mm		499	699	899	899	1099	
Mounting plate height (G) mm		1696	1696	1696	1696	1696	
Model No.	1 pc(s).	8684.000	8884.000	8080.000	8084.000	8284.000	
Weight kg		86.9	109.0	138.0	133.0	166.0	
Product-specific scope of supply							
Door(s)		1	1	2	1	2	
Accessories							
Base/plinth corner pieces with base/plinth trim panels, front and rear, 100 mm	2 pc(s).	8640.002	8640.003	8640.005	8640.005	8640.007	881
Base/plinth trim panels, sides, 100 mm	2 pc(s).	8640.031	8640.031	8640.031	8640.031	8640.031	882
Base/plinth corner pieces with base/plinth trim panels, front and rear, 200 mm	2 pc(s).	8640.022	8640.023	8640.024	8640.024	8640.025	881
Base/plinth trim panels, sides, 200 mm	2 pc(s).	8640.041	8640.041	8640.041	8640.041	8640.041	882
Levelling feet	4 pc(s).	4612.000	4612.000	4612.000	4612.000	4612.000	892
Side panels, screw-fastened, sheet steel	2 pc(s).	8184.245	8184.245	8184.245	8184.245	8184.245	901
Divider panel	1 pc(s).	8609.200	8609.200	8609.200	8609.200	8609.200	905
Divider panel for module plates		-	-	-	-	-	
Baying bracket, internal	6 pc(s).	8617.500	8617.500	8617.500	8617.500	8617.500	912
Baying block, internal	6 pc(s).	8617.501	8617.501	8617.501	8617.501	8617.501	912
Baying connector, external	6 pc(s).	8617.502	8617.502	8617.502	8617.502	8617.502	912
Glazed door	1 pc(s).	8618.000	8618.010	-	-	-	917
Comfort handle VX for lock inserts	1 pc(s).	8618.200	8618.200	8618.200	8618.200	8618.200	937
Comfort handle VX for lock inserts and padlock	1 pc(s).	8618.230	8618.230	8618.230	8618.230	8618.230	937
Comfort handle VX for profile half-cylinders	1 pc(s).	8618.250	8618.250	8618.250	8618.250	8618.250	937
Comfort handle VX with security lock insert, lock E1	1 pc(s).	8618.240	8618.240	8618.240	8618.240	8618.240	937
Comfort handle VX for ASSA lock system	1 pc(s).	8618.270	8618.270	8618.270	8618.270	8618.270	937
Lock inserts		see page	see page	see page	see page	see page	941, 942
180° hinges	4 pc(s).	8618.330	8618.330	8618.330	8618.330	8618.330	951
Punched section with mounting flange, 14 x 39 mm, for tubular door frame	4 pc(s).	8619.720	8619.730	8619.710	8619.750	8619.720	952
Wiring plan pocket, sheet steel, depth 35 mm	1 pc(s).	4116.500	4118.500	4115.500	-	4116.500	955
Wiring plan pocket, sheet steel, depth 90 mm	1 pc(s).	4116.000	4118.000	4115.000	4124.000	4116.000	955
Door stay	1 pc(s).	8618.430	8618.430	8618.430	8618.430	8618.430	956
Door stay for escape routes	1 pc(s).	8618.425	8618.425	8618.425	8618.425	8618.425	956
Ride-up roller	10 pc(s).	8618.420	8618.420	8618.420	8618.420	8618.420	956
Mounting plate infill	1 pc(s).	4590.700	4590.700	4590.700	4590.700	4590.700	971
Punched section with mounting flange 18 x 64 mm for the outer level, in the width	4 pc(s).	8617.030	8617.040	8617.050	8617.050	8617.060	990
Punched section with mounting flange 18 x 64 mm for the outer level, in the depth	4 pc(s).	8617.010	8617.010	8617.010	8617.010	8617.010	990
Punched section with mounting flange 23 x 64 mm for the inner level, in the width	4 pc(s).	8617.130	8617.140	8617.150	8617.150	8617.160	991
Punched section with mounting flange 23 x 64 mm for the inner level, in the depth	4 pc(s).	8617.110	8617.110	8617.110	8617.110	8617.110	991
Punched rail 18 x 39 mm for the enclosure depth	4 pc(s).	8617.700	8617.700	8617.700	8617.700	8617.700	993
Support strip for the enclosure depth	20 pc(s).	4694.000	4694.000	4694.000	4694.000	4694.000	994
C rail 30/15, for the enclosure width	6 pc(s).	4944.000	4945.000	4946.000	4946.000	4947.000	996
Support rail 48 x 26 mm, for the enclosure width	2 pc(s).	8617.800	8617.810	8617.820	8617.820	8617.830	996
LED system light		see page	see page	see page	see page	see page	1014
Earth straps		see page	see page	see page	see page	see page	1033
Cable entry plates		8619.800	8619.801	8619.802	8619.802	8619.803	1044
Cable entry grommets	Packs of	2 pc(s).	2 pc(s).	4 pc(s).	4 pc(s).	4 pc(s).	
	8 cables, max. Ø 13 mm	25 pc(s).	4316.000	4316.000	4316.000	4316.000	1044
	3 cables, max. Ø 21 mm	25 pc(s).	4317.000	4317.000	4317.000	4317.000	1044
Connector grommets	10 pc(s).	4318.000	4318.000	4318.000	4318.000	4318.000	1044
Section for cable entry, centre		8618.800	8618.801	8618.802	8618.802	8618.803	1045
	Packs of	2 pc(s).	2 pc(s).	4 pc(s).	4 pc(s).	4 pc(s).	
Section for cable entry, rear		8618.810	8618.811	8618.812	8618.812	8618.813	1045
	Packs of	2 pc(s).	2 pc(s).	4 pc(s).	4 pc(s).	4 pc(s).	
Cable duct		see page	see page	see page	see page	see page	1058
Cable clamp rail, right angle section	2 pc(s).	8619.410	8619.420	8619.430	8619.430	8619.440	1059

Baying enclosure system VX25

Basic enclosure, height 1800 mm, depth 500 mm

Width (B) mm	Packs of	400	600	800	800	1200	Page
Height (H) mm		1800	1800	1800	1800	1800	
Depth (T) mm		500	500	500	500	500	
Mounting plate width (F) mm		299	499	699	699	1099	
Mounting plate height (G) mm		1696	1696	1696	1696	1696	
Model No.	1 pc(s).	8485.000	8685.000	8880.000	8885.000	8285.000	
Weight kg		66.4	90.0	119.0	113.0	173.0	
Product-specific scope of supply							
Door(s)		1	1	2	1	2	
Accessories							
Base/plinth corner pieces with base/plinth trim panels, front and rear, 100 mm	2 pc(s).	8640.001	8640.002	8640.003	8640.003	8640.007	881
Base/plinth trim panels, sides, 100 mm	2 pc(s).	8640.032	8640.032	8640.032	8640.032	8640.032	882
Base/plinth corner pieces with base/plinth trim panels, front and rear, 200 mm	2 pc(s).	8640.021	8640.022	8640.023	8640.023	8640.025	881
Base/plinth trim panels, sides, 200 mm	2 pc(s).	8640.042	8640.042	8640.042	8640.042	8640.042	882
Levelling feet	4 pc(s).	4612.000	4612.000	4612.000	4612.000	4612.000	892
Side panels, screw-fastened, sheet steel	2 pc(s).	8185.245	8185.245	8185.245	8185.245	8185.245	901
Divider panel	1 pc(s).	8609.201	8609.201	8609.201	8609.201	8609.201	905
Divider panel for module plates	1 pc(s).	8609.210	8609.210	8609.210	8609.210	8609.210	906
Baying bracket, internal	6 pc(s).	8617.500	8617.500	8617.500	8617.500	8617.500	912
Baying block, internal	6 pc(s).	8617.501	8617.501	8617.501	8617.501	8617.501	912
Baying connector, external	6 pc(s).	8617.502	8617.502	8617.502	8617.502	8617.502	912
Glazed door	1 pc(s).	–	8618.000	–	8618.010	–	917
Comfort handle VX for lock inserts	1 pc(s).	8618.200	8618.200	8618.200	8618.200	8618.200	937
Comfort handle VX for lock inserts and padlock	1 pc(s).	8618.230	8618.230	8618.230	8618.230	8618.230	937
Comfort handle VX for profile half-cylinders	1 pc(s).	8618.250	8618.250	8618.250	8618.250	8618.250	937
Comfort handle VX with security lock insert, lock E1	1 pc(s).	8618.240	8618.240	8618.240	8618.240	8618.240	937
Comfort handle VX for ASSA lock system	1 pc(s).	8618.270	8618.270	8618.270	8618.270	8618.270	937
Lock inserts		see page	see page	see page	see page	see page	941, 942
180° hinges	4 pc(s).	8618.330	8618.330	8618.330	8618.330	8618.330	951
Punched section with mounting flange, 14 x 39 mm, for tubular door frame	4 pc(s).	8619.700	8619.720	8619.700	8619.730	8619.720	952
Wiring plan pocket, sheet steel, depth 35 mm	1 pc(s).	–	4116.500	–	4118.500	4116.500	955
Wiring plan pocket, sheet steel, depth 90 mm	1 pc(s).	4114.000	4116.000	4114.000	4118.000	4116.000	955
Door stay	1 pc(s).	8618.430	8618.430	8618.430	8618.430	8618.430	956
Door stay for escape routes	1 pc(s).	8618.425	8618.425	8618.425	8618.425	8618.425	956
Ride-up roller	10 pc(s).	8618.420	8618.420	8618.420	8618.420	8618.420	956
Mounting plate infill	1 pc(s).	4590.700	4590.700	4590.700	4590.700	4590.700	971
Punched section with mounting flange 18 x 64 mm for the outer level, in the width	4 pc(s).	8617.010	8617.030	8617.040	8617.040	8617.060	990
Punched section with mounting flange 18 x 64 mm for the outer level, in the depth	4 pc(s).	8617.020	8617.020	8617.020	8617.020	8617.020	990
Punched section with mounting flange 23 x 64 mm for the inner level, in the width	4 pc(s).	8617.110	8617.130	8617.140	8617.140	8617.160	991
Punched section with mounting flange 23 x 64 mm for the inner level, in the depth	4 pc(s).	8617.120	8617.120	8617.120	8617.120	8617.120	991
Punched rail 18 x 39 mm for the enclosure depth	4 pc(s).	8617.710	8617.710	8617.710	8617.710	8617.710	993
Support strip for the enclosure depth	20 pc(s).	4695.000	4695.000	4695.000	4695.000	4695.000	994
C rail 30/15, for the enclosure width	6 pc(s).	–	4944.000	4945.000	4945.000	4947.000	996
Support rail 48 x 26 mm, for the enclosure width	2 pc(s).	–	8617.800	8617.810	8617.810	8617.830	996
LED system light		see page	see page	see page	see page	see page	1014
Earth straps		see page	see page	see page	see page	see page	1033
Cable entry plates		–	8619.800	8619.801	8619.801	8619.803	1044
Cable entry grommets	Packs of	–	2 pc(s).	2 pc(s).	2 pc(s).	4 pc(s).	
	8 cables, max. Ø 13 mm	25 pc(s).	4316.000	4316.000	4316.000	4316.000	1044
	3 cables, max. Ø 21 mm	25 pc(s).	4317.000	4317.000	4317.000	4317.000	1044
Connector grommets	1 cable, max. Ø 47 mm	25 pc(s).	4318.000	4318.000	4318.000	4318.000	1044
Connector grommets		10 pc(s).	4311.000	4311.000	4311.000	4311.000	1044
Section for cable entry, centre		–	8618.800	8618.801	8618.801	8618.803	1045
Section for cable entry, rear	Packs of	–	2 pc(s).	2 pc(s).	2 pc(s).	4 pc(s).	
		–	8618.810	8618.811	8618.811	8618.813	1045
Cable duct		see page	see page	see page	see page	see page	1058
Cable clamp rail, right angle section	2 pc(s).	8619.400	8619.410	8619.420	8619.420	8619.440	1059

Baying enclosure system VX25

Basic enclosure, height 1800 mm, depth 600 mm

Width (B) mm	Packs of	400	600	800	800	1200	Page
Height (H) mm		1800	1800	1800	1800	1800	
Depth (T) mm		600	600	600	600	600	
Mounting plate width (F) mm		299	499	699	699	1099	
Mounting plate height (G) mm		1696	1696	1696	1696	1696	
Model No.	1 pc(s).	8486.000	8686.000	8881.000	8886.000	8286.000	
Weight kg		69.6	92.3	121.0	116.0	174.0	
Product-specific scope of supply							
Door(s)		1	1	2	1	2	
Accessories							
Base/plinth corner pieces with base/plinth trim panels, front and rear, 100 mm	2 pc(s).	8640.001	8640.002	8640.003	8640.003	8640.007	881
Base/plinth trim panels, sides, 100 mm	2 pc(s).	8640.033	8640.033	8640.033	8640.033	8640.033	882
Base/plinth corner pieces with base/plinth trim panels, front and rear, 200 mm	2 pc(s).	8640.021	8640.022	8640.023	8640.023	8640.025	881
Base/plinth trim panels, sides, 200 mm	2 pc(s).	8640.043	8640.043	8640.043	8640.043	8640.043	882
Levelling feet	4 pc(s).	4612.000	4612.000	4612.000	4612.000	4612.000	892
Side panels, screw-fastened, sheet steel	2 pc(s).	8186.245	8186.245	8186.245	8186.245	8186.245	901
Divider panel	1 pc(s).	8609.202	8609.202	8609.202	8609.202	8609.202	905
Divider panel for module plates	1 pc(s).	8609.211	8609.211	8609.211	8609.211	8609.211	906
Baying bracket, internal	6 pc(s).	8617.500	8617.500	8617.500	8617.500	8617.500	912
Baying block, internal	6 pc(s).	8617.501	8617.501	8617.501	8617.501	8617.501	912
Baying connector, external	6 pc(s).	8617.502	8617.502	8617.502	8617.502	8617.502	912
Glazed door	1 pc(s).	–	8618.000	–	8618.010	–	917
Comfort handle VX for lock inserts	1 pc(s).	8618.200	8618.200	8618.200	8618.200	8618.200	937
Comfort handle VX for lock inserts and padlock	1 pc(s).	8618.230	8618.230	8618.230	8618.230	8618.230	937
Comfort handle VX for profile half-cylinders	1 pc(s).	8618.250	8618.250	8618.250	8618.250	8618.250	937
Comfort handle VX with security lock insert, lock E1	1 pc(s).	8618.240	8618.240	8618.240	8618.240	8618.240	937
Comfort handle VX for ASSA lock system	1 pc(s).	8618.270	8618.270	8618.270	8618.270	8618.270	937
Lock inserts		see page	see page	see page	see page	see page	941, 942
180° hinges	4 pc(s).	8618.330	8618.330	8618.330	8618.330	8618.330	951
Punched section with mounting flange, 14 x 39 mm, for tubular door frame	4 pc(s).	8619.700	8619.720	8619.700	8619.730	8619.720	952
Wiring plan pocket, sheet steel, depth 35 mm	1 pc(s).	–	4116.500	–	4118.500	4116.500	955
Wiring plan pocket, sheet steel, depth 90 mm	1 pc(s).	4114.000	4116.000	4114.000	4118.000	4116.000	955
Door stay	1 pc(s).	8618.430	8618.430	8618.430	8618.430	8618.430	956
Door stay for escape routes	1 pc(s).	8618.425	8618.425	8618.425	8618.425	8618.425	956
Ride-up roller	10 pc(s).	8618.420	8618.420	8618.420	8618.420	8618.420	956
Mounting plate infill	1 pc(s).	4590.700	4590.700	4590.700	4590.700	4590.700	971
Punched section with mounting flange 18 x 64 mm for the outer level, in the width	4 pc(s).	8617.010	8617.030	8617.040	8617.040	8617.060	990
Punched section with mounting flange 18 x 64 mm for the outer level, in the depth	4 pc(s).	8617.030	8617.030	8617.030	8617.030	8617.030	990
Punched section with mounting flange 23 x 64 mm for the inner level, in the width	4 pc(s).	8617.110	8617.130	8617.140	8617.140	8617.160	991
Punched section with mounting flange 23 x 64 mm for the inner level, in the depth	4 pc(s).	8617.130	8617.130	8617.130	8617.130	8617.130	991
Punched rail 18 x 39 mm for the enclosure depth	4 pc(s).	8617.720	8617.720	8617.720	8617.720	8617.720	993
Support strip for the enclosure depth	20 pc(s).	4696.000	4696.000	4696.000	4696.000	4696.000	994
C rail 30/15, for the enclosure width	6 pc(s).	–	4944.000	4945.000	4945.000	4947.000	996
Support rail 48 x 26 mm, for the enclosure width	2 pc(s).	–	8617.800	8617.810	8617.810	8617.830	996
LED system light		see page	see page	see page	see page	see page	1014
Earth straps		see page	see page	see page	see page	see page	1033
Cable entry plates		–	8619.800	8619.801	8619.801	8619.803	1044
Cable entry grommets	Packs of	–	2 pc(s).	2 pc(s).	2 pc(s).	4 pc(s).	
	8 cables, max. Ø 13 mm	25 pc(s).	4316.000	4316.000	4316.000	4316.000	1044
	3 cables, max. Ø 21 mm	25 pc(s).	4317.000	4317.000	4317.000	4317.000	1044
Connector grommets	10 pc(s).	4318.000	4318.000	4318.000	4318.000	4318.000	1044
Section for cable entry, centre		–	8618.800	8618.801	8618.801	8618.803	1045
	Packs of	–	2 pc(s).	2 pc(s).	2 pc(s).	4 pc(s).	
Section for cable entry, rear		–	8618.810	8618.811	8618.811	8618.813	1045
	Packs of	–	2 pc(s).	2 pc(s).	2 pc(s).	4 pc(s).	
Cable duct		see page	see page	see page	see page	see page	1058
Cable clamp rail, right angle section	2 pc(s).	8619.400	8619.410	8619.420	8619.420	8619.440	1059

Baying enclosure system VX25

Basic enclosure, height 2000 mm, depth 400 mm

Width (B) mm	Packs of	600	800	1000	1200	Page	
Height (H) mm		2000	2000	2000	2000		
Depth (T) mm		400	400	400	400		
Mounting plate width (F) mm		499	699	899	1099		
Mounting plate height (G) mm		1896	1896	1896	1896		
Model No.	1 pc(s).	8604.000	8804.000	8004.000	8204.000		
Weight kg		95.4	120.0	152.0	183.0		
Product-specific scope of supply							
Door(s)		1	1	2	2		
Accessories							
Base/plinth corner pieces with base/plinth trim panels, front and rear, 100 mm	2 pc(s).	8640.002	8640.003	8640.005	8640.007	881	
Base/plinth trim panels, sides, 100 mm	2 pc(s).	8640.031	8640.031	8640.031	8640.031	882	
Base/plinth corner pieces with base/plinth trim panels, front and rear, 200 mm	2 pc(s).	8640.022	8640.023	8640.024	8640.025	881	
Base/plinth trim panels, sides, 200 mm	2 pc(s).	8640.041	8640.041	8640.041	8640.041	882	
Levelling feet	4 pc(s).	4612.000	4612.000	4612.000	4612.000	892	
Side panels, screw-fastened, sheet steel	2 pc(s).	8104.245	8104.245	8104.245	8104.245	901	
Divider panel	1 pc(s).	8609.203	8609.203	8609.203	8609.203	905	
Divider panel for module plates		-	-	-	-		
Baying bracket, internal	6 pc(s).	8617.500	8617.500	8617.500	8617.500	912	
Baying block, internal	6 pc(s).	8617.501	8617.501	8617.501	8617.501	912	
Baying connector, external	6 pc(s).	8617.502	8617.502	8617.502	8617.502	912	
Glazed door	1 pc(s).	8618.020	8618.030	-	-	917	
Comfort handle VX for lock inserts	1 pc(s).	8618.200	8618.200	8618.200	8618.200	937	
Comfort handle VX for lock inserts and padlock	1 pc(s).	8618.230	8618.230	8618.230	8618.230	937	
Comfort handle VX for profile half-cylinders	1 pc(s).	8618.250	8618.250	8618.250	8618.250	937	
Comfort handle VX with security lock insert, lock E1	1 pc(s).	8618.240	8618.240	8618.240	8618.240	937	
Comfort handle VX for ASSA lock system	1 pc(s).	8618.270	8618.270	8618.270	8618.270	937	
Lock inserts		see page	see page	see page	see page	941, 942	
180° hinges	4 pc(s).	8618.330	8618.330	8618.330	8618.330	951	
Punched section with mounting flange, 14 x 39 mm, for tubular door frame	4 pc(s).	8619.720	8619.730	8619.710	8619.720	952	
Wiring plan pocket, sheet steel, depth 35 mm	1 pc(s).	4116.500	4118.500	4115.500	4116.500	955	
Wiring plan pocket, sheet steel, depth 90 mm	1 pc(s).	4116.000	4118.000	4115.000	4116.000	955	
Door stay	1 pc(s).	8618.430	8618.430	8618.430	8618.430	956	
Door stay for escape routes	1 pc(s).	8618.425	8618.425	8618.425	8618.425	956	
Ride-up roller	10 pc(s).	8618.420	8618.420	8618.420	8618.420	956	
Mounting plate infill	1 pc(s).	4591.700	4591.700	4591.700	4591.700	971	
Punched section with mounting flange 18 x 64 mm for the outer level, in the width	4 pc(s).	8617.030	8617.040	8617.050	8617.060	990	
Punched section with mounting flange 18 x 64 mm for the outer level, in the depth	4 pc(s).	8617.010	8617.010	8617.010	8617.010	990	
Punched section with mounting flange 23 x 64 mm for the inner level, in the width	4 pc(s).	8617.130	8617.140	8617.150	8617.160	991	
Punched section with mounting flange 23 x 64 mm for the inner level, in the depth	4 pc(s).	8617.110	8617.110	8617.110	8617.110	991	
Punched rail 18 x 39 mm for the enclosure depth	4 pc(s).	8617.700	8617.700	8617.700	8617.700	993	
Support strip for the enclosure depth	20 pc(s).	4694.000	4694.000	4694.000	4694.000	994	
C rail 30/15, for the enclosure width	6 pc(s).	4944.000	4945.000	4946.000	4947.000	996	
Support rail 48 x 26 mm, for the enclosure width	2 pc(s).	8617.800	8617.810	8617.820	8617.830	996	
LED system light		see page	see page	see page	see page	1014	
Earth straps		see page	see page	see page	see page	1033	
Cable entry plates		8619.800	8619.801	8619.802	8619.803	1044	
	Packs of	2 pc(s).	2 pc(s).	4 pc(s).	4 pc(s).		
Cable entry grommets	8 cables, max. Ø 13 mm	25 pc(s).	4316.000	4316.000	4316.000	4316.000	1044
	3 cables, max. Ø 21 mm	25 pc(s).	4317.000	4317.000	4317.000	4317.000	1044
	1 cable, max. Ø 47 mm	25 pc(s).	4318.000	4318.000	4318.000	4318.000	1044
Connector grommets	10 pc(s).	4311.000	4311.000	4311.000	4311.000	1044	
Section for cable entry, centre		8618.800	8618.801	8618.802	8618.803	1045	
	Packs of	2 pc(s).	2 pc(s).	4 pc(s).	4 pc(s).		
Section for cable entry, rear		8618.810	8618.811	8618.812	8618.813	1045	
	Packs of	2 pc(s).	2 pc(s).	4 pc(s).	4 pc(s).		
Cable duct		see page	see page	see page	see page	1058	
Cable clamp rail, right angle section	2 pc(s).	8619.410	8619.420	8619.430	8619.440	1059	

Baying enclosure system VX25

Basic enclosure, height 2000 mm, depth 500 mm

Width (B) mm	Packs of	400	600	800	1000	1200	Page
Height (H) mm		2000	2000	2000	2000	2000	
Depth (T) mm		500	500	500	500	500	
Mounting plate width (F) mm		299	499	699	899	1099	
Mounting plate height (G) mm		1896	1896	1896	1896	1896	
Model No.	1 pc(s).	8405.000	8605.000	8805.000	8005.000	8205.000	
Weight kg		73.0	98.0	122.0	156.0	187.0	
Product-specific scope of supply							
Door(s)		1	1	1	2	2	
Accessories							
Base/plinth corner pieces with base/plinth trim panels, front and rear, 100 mm	2 pc(s).	8640.001	8640.002	8640.003	8640.005	8640.007	881
Base/plinth trim panels, sides, 100 mm	2 pc(s).	8640.032	8640.032	8640.032	8640.032	8640.032	882
Base/plinth corner pieces with base/plinth trim panels, front and rear, 200 mm	2 pc(s).	8640.021	8640.022	8640.023	8640.024	8640.025	881
Base/plinth trim panels, sides, 200 mm	2 pc(s).	8640.042	8640.042	8640.042	8640.042	8640.042	882
Levelling feet	4 pc(s).	4612.000	4612.000	4612.000	4612.000	4612.000	892
Side panels, screw-fastened, sheet steel	2 pc(s).	8105.245	8105.245	8105.245	8105.245	8105.245	901
Divider panel	1 pc(s).	8609.204	8609.204	8609.204	8609.204	8609.204	905
Divider panel for module plates	1 pc(s).	8609.212	8609.212	8609.212	8609.212	8609.212	906
Baying bracket, internal	6 pc(s).	8617.500	8617.500	8617.500	8617.500	8617.500	912
Baying block, internal	6 pc(s).	8617.501	8617.501	8617.501	8617.501	8617.501	912
Baying connector, external	6 pc(s).	8617.502	8617.502	8617.502	8617.502	8617.502	912
Glazed door	1 pc(s).	–	8618.020	8618.030	–	–	917
Comfort handle VX for lock inserts	1 pc(s).	8618.200	8618.200	8618.200	8618.200	8618.200	937
Comfort handle VX for lock inserts and padlock	1 pc(s).	8618.230	8618.230	8618.230	8618.230	8618.230	937
Comfort handle VX for profile half-cylinders	1 pc(s).	8618.250	8618.250	8618.250	8618.250	8618.250	937
Comfort handle VX with security lock insert, lock E1	1 pc(s).	8618.240	8618.240	8618.240	8618.240	8618.240	937
Comfort handle VX for ASSA lock system	1 pc(s).	8618.270	8618.270	8618.270	8618.270	8618.270	937
Lock inserts		see page	see page	see page	see page	see page	941, 942
180° hinges	4 pc(s).	8618.330	8618.330	8618.330	8618.330	8618.330	951
Punched section with mounting flange, 14 x 39 mm, for tubular door frame	4 pc(s).	8619.700	8619.720	8619.730	8619.710	8619.720	952
Wiring plan pocket, sheet steel, depth 35 mm	1 pc(s).	–	4116.500	4118.500	4115.500	4116.500	955
Wiring plan pocket, sheet steel, depth 90 mm	1 pc(s).	4114.000	4116.000	4118.000	4115.000	4116.000	955
Door stay	1 pc(s).	8618.430	8618.430	8618.430	8618.430	8618.430	956
Door stay for escape routes	1 pc(s).	8618.425	8618.425	8618.425	8618.425	8618.425	956
Ride-up roller	10 pc(s).	8618.420	8618.420	8618.420	8618.420	8618.420	956
Mounting plate infill	1 pc(s).	4591.700	4591.700	4591.700	4591.700	4591.700	971
Punched section with mounting flange 18 x 64 mm for the outer level, in the width	4 pc(s).	8617.010	8617.030	8617.040	8617.050	8617.060	990
Punched section with mounting flange 18 x 64 mm for the outer level, in the depth	4 pc(s).	8617.020	8617.020	8617.020	8617.020	8617.020	990
Punched section with mounting flange 23 x 64 mm for the inner level, in the width	4 pc(s).	8617.110	8617.130	8617.140	8617.150	8617.160	991
Punched section with mounting flange 23 x 64 mm for the inner level, in the depth	4 pc(s).	8617.120	8617.120	8617.120	8617.120	8617.120	991
Punched rail 18 x 39 mm for the enclosure depth	4 pc(s).	8617.710	8617.710	8617.710	8617.710	8617.710	993
Support strip for the enclosure depth	20 pc(s).	4695.000	4695.000	4695.000	4695.000	4695.000	994
C rail 30/15, for the enclosure width	6 pc(s).	–	4944.000	4945.000	4946.000	4947.000	996
Support rail 48 x 26 mm, for the enclosure width	2 pc(s).	–	8617.800	8617.810	8617.820	8617.830	996
LED system light		see page	see page	see page	see page	see page	1014
Earth straps		see page	see page	see page	see page	see page	1033
Cable entry plates		–	8619.800	8619.801	8619.802	8619.803	1044
Cable entry grommets	Packs of	–	2 pc(s).	2 pc(s).	4 pc(s).	4 pc(s).	
	8 cables, max. Ø 13 mm	25 pc(s).	4316.000	4316.000	4316.000	4316.000	1044
	3 cables, max. Ø 21 mm	25 pc(s).	4317.000	4317.000	4317.000	4317.000	1044
Connector grommets	1 cable, max. Ø 47 mm	25 pc(s).	4318.000	4318.000	4318.000	4318.000	1044
Section for cable entry, centre	10 pc(s).	4311.000	4311.000	4311.000	4311.000	4311.000	1044
Section for cable entry, rear		–	8618.800	8618.801	8618.802	8618.803	1045
	Packs of	–	2 pc(s).	2 pc(s).	4 pc(s).	4 pc(s).	
Cable duct		–	8618.810	8618.811	8618.812	8618.813	1045
	Packs of	–	2 pc(s).	2 pc(s).	4 pc(s).	4 pc(s).	
Cable clamp rail, right angle section		see page	see page	see page	see page	see page	1058
	2 pc(s).	8619.400	8619.410	8619.420	8619.430	8619.440	1059

Baying enclosure system VX25

Basic enclosure, height 2000 mm, depth 600 mm

Width (B) mm	Packs of	400	600	800	1000	1200	Page
Height (H) mm		2000	2000	2000	2000	2000	
Depth (T) mm		600	600	600	600	600	
Mounting plate width (F) mm		299	499	699	899	1099	
Mounting plate height (G) mm		1896	1896	1896	1896	1896	
Model No.	1 pc(s).	8406.000	8606.000	8806.000	8006.000	8206.000	
Weight kg		75.2	101.0	126.0	160.0	191.0	
Product-specific scope of supply							
Door(s)		1	1	1	2	2	
Accessories							
Base/plinth corner pieces with base/plinth trim panels, front and rear, 100 mm	2 pc(s).	8640.001	8640.002	8640.003	8640.005	8640.007	881
Base/plinth trim panels, sides, 100 mm	2 pc(s).	8640.033	8640.033	8640.033	8640.033	8640.033	882
Base/plinth corner pieces with base/plinth trim panels, front and rear, 200 mm	2 pc(s).	8640.021	8640.022	8640.023	8640.024	8640.025	881
Base/plinth trim panels, sides, 200 mm	2 pc(s).	8640.043	8640.043	8640.043	8640.043	8640.043	882
Levelling feet	4 pc(s).	4612.000	4612.000	4612.000	4612.000	4612.000	892
Side panels, screw-fastened, sheet steel	2 pc(s).	8106.245	8106.245	8106.245	8106.245	8106.245	901
Divider panel	1 pc(s).	8609.205	8609.205	8609.205	8609.205	8609.205	905
Divider panel for module plates	1 pc(s).	8609.213	8609.213	8609.213	8609.213	8609.213	906
Baying bracket, internal	6 pc(s).	8617.500	8617.500	8617.500	8617.500	8617.500	912
Baying block, internal	6 pc(s).	8617.501	8617.501	8617.501	8617.501	8617.501	912
Baying connector, external	6 pc(s).	8617.502	8617.502	8617.502	8617.502	8617.502	912
Glazed door	1 pc(s).	–	8618.020	8618.030	–	–	917
Comfort handle VX for lock inserts	1 pc(s).	8618.200	8618.200	8618.200	8618.200	8618.200	937
Comfort handle VX for lock inserts and padlock	1 pc(s).	8618.230	8618.230	8618.230	8618.230	8618.230	937
Comfort handle VX for profile half-cylinders	1 pc(s).	8618.250	8618.250	8618.250	8618.250	8618.250	937
Comfort handle VX with security lock insert, lock E1	1 pc(s).	8618.240	8618.240	8618.240	8618.240	8618.240	937
Comfort handle VX for ASSA lock system	1 pc(s).	8618.270	8618.270	8618.270	8618.270	8618.270	937
Lock inserts		see page	see page	see page	see page	see page	941, 942
180° hinges	4 pc(s).	8618.330	8618.330	8618.330	8618.330	8618.330	951
Punched section with mounting flange, 14 x 39 mm, for tubular door frame	4 pc(s).	8619.700	8619.720	8619.730	8619.710	8619.720	952
Wiring plan pocket, sheet steel, depth 35 mm	1 pc(s).	–	4116.500	4118.500	4115.500	4116.500	955
Wiring plan pocket, sheet steel, depth 90 mm	1 pc(s).	4114.000	4116.000	4118.000	4115.000	4116.000	955
Door stay	1 pc(s).	8618.430	8618.430	8618.430	8618.430	8618.430	956
Door stay for escape routes	1 pc(s).	8618.425	8618.425	8618.425	8618.425	8618.425	956
Ride-up roller	10 pc(s).	8618.420	8618.420	8618.420	8618.420	8618.420	956
Mounting plate infill	1 pc(s).	4591.700	4591.700	4591.700	4591.700	4591.700	971
Punched section with mounting flange 18 x 64 mm for the outer level, in the width	4 pc(s).	8617.010	8617.030	8617.040	8617.050	8617.060	990
Punched section with mounting flange 18 x 64 mm for the outer level, in the depth	4 pc(s).	8617.030	8617.030	8617.030	8617.030	8617.030	990
Punched section with mounting flange 23 x 64 mm for the inner level, in the width	4 pc(s).	8617.110	8617.130	8617.140	8617.150	8617.160	991
Punched section with mounting flange 23 x 64 mm for the inner level, in the depth	4 pc(s).	8617.130	8617.130	8617.130	8617.130	8617.130	991
Punched rail 18 x 39 mm for the enclosure depth	4 pc(s).	8617.720	8617.720	8617.720	8617.720	8617.720	993
Support strip for the enclosure depth	20 pc(s).	4696.000	4696.000	4696.000	4696.000	4696.000	994
C rail 30/15, for the enclosure width	6 pc(s).	–	4944.000	4945.000	4946.000	4947.000	996
Support rail 48 x 26 mm, for the enclosure width	2 pc(s).	–	8617.800	8617.810	8617.820	8617.830	996
LED system light		see page	see page	see page	see page	see page	1014
Earth straps		see page	see page	see page	see page	see page	1033
Cable entry plates		–	8619.800	8619.801	8619.802	8619.803	1044
Cable entry grommets	Packs of	–	2 pc(s).	2 pc(s).	4 pc(s).	4 pc(s).	
	8 cables, max. Ø 13 mm	25 pc(s).	4316.000	4316.000	4316.000	4316.000	1044
	3 cables, max. Ø 21 mm	25 pc(s).	4317.000	4317.000	4317.000	4317.000	1044
Connector grommets	25 pc(s).	4318.000	4318.000	4318.000	4318.000	4318.000	1044
Connector grommets	10 pc(s).	4311.000	4311.000	4311.000	4311.000	4311.000	1044
Section for cable entry, centre		–	8618.800	8618.801	8618.802	8618.803	1045
Section for cable entry, rear	Packs of	–	2 pc(s).	2 pc(s).	4 pc(s).	4 pc(s).	
		–	8618.810	8618.811	8618.812	8618.813	1045
Cable duct		see page	see page	see page	see page	see page	1058
Cable clamp rail, right angle section	2 pc(s).	8619.400	8619.410	8619.420	8619.430	8619.440	1059

Baying enclosure system VX25

Basic enclosure, height 2000 mm, depth 800 mm

Width (B) mm	Packs of	600	800	1200	Page
Height (H) mm		2000	2000	2000	
Depth (T) mm		800	800	800	
Mounting plate width (F) mm		499	699	1099	
Mounting plate height (G) mm		1896	1896	1896	
Model No.	1 pc(s).	8608.000	8808.000	8208.000	
Weight kg		106.0	138.0	201.0	
Product-specific scope of supply					
Door(s)		1	1	2	
Accessories					
Base/plinth corner pieces with base/plinth trim panels, front and rear, 100 mm	2 pc(s).	8640.002	8640.003	8640.007	881
Base/plinth trim panels, sides, 100 mm	2 pc(s).	8640.034	8640.034	8640.034	882
Base/plinth corner pieces with base/plinth trim panels, front and rear, 200 mm	2 pc(s).	8640.022	8640.023	8640.025	881
Base/plinth trim panels, sides, 200 mm	2 pc(s).	8640.044	8640.044	8640.044	882
Levelling feet	4 pc(s).	4612.000	4612.000	4612.000	892
Side panels, screw-fastened, sheet steel	2 pc(s).	8108.245	8108.245	8108.245	901
Divider panel	1 pc(s).	8609.206	8609.206	8609.206	905
Divider panel for module plates		-	-	-	
Baying bracket, internal	6 pc(s).	8617.500	8617.500	8617.500	912
Baying block, internal	6 pc(s).	8617.501	8617.501	8617.501	912
Baying connector, external	6 pc(s).	8617.502	8617.502	8617.502	912
Glazed door	1 pc(s).	8618.020	8618.030	-	917
Comfort handle VX for lock inserts	1 pc(s).	8618.200	8618.200	8618.200	937
Comfort handle VX for lock inserts and padlock	1 pc(s).	8618.230	8618.230	8618.230	937
Comfort handle VX for profile half-cylinders	1 pc(s).	8618.250	8618.250	8618.250	937
Comfort handle VX with security lock insert, lock E1	1 pc(s).	8618.240	8618.240	8618.240	937
Comfort handle VX for ASSA lock system	1 pc(s).	8618.270	8618.270	8618.270	937
Lock inserts		see page	see page	see page	941, 942
180° hinges	4 pc(s).	8618.330	8618.330	8618.330	951
Punched section with mounting flange, 14 x 39 mm, for tubular door frame	4 pc(s).	8619.720	8619.730	8619.720	952
Wiring plan pocket, sheet steel, depth 35 mm	1 pc(s).	4116.500	4118.500	4116.500	955
Wiring plan pocket, sheet steel, depth 90 mm	1 pc(s).	4116.000	4118.000	4116.000	955
Door stay	1 pc(s).	8618.430	8618.430	8618.430	956
Door stay for escape routes	1 pc(s).	8618.425	8618.425	8618.425	956
Ride-up roller	10 pc(s).	8618.420	8618.420	8618.420	956
Mounting plate infill	1 pc(s).	4591.700	4591.700	4591.700	971
Punched section with mounting flange 18 x 64 mm for the outer level, in the width	4 pc(s).	8617.030	8617.040	8617.060	990
Punched section with mounting flange 18 x 64 mm for the outer level, in the depth	4 pc(s).	8617.040	8617.040	8617.040	990
Punched section with mounting flange 23 x 64 mm for the inner level, in the width	4 pc(s).	8617.130	8617.140	8617.160	991
Punched section with mounting flange 23 x 64 mm for the inner level, in the depth	4 pc(s).	8617.140	8617.140	8617.140	991
Punched rail 18 x 39 mm for the enclosure depth	4 pc(s).	8617.730	8617.730	8617.730	993
Support strip for the enclosure depth	20 pc(s).	4697.000	4697.000	4697.000	994
C rail 30/15, for the enclosure width	6 pc(s).	4944.000	4945.000	4947.000	996
Support rail 48 x 26 mm, for the enclosure width	2 pc(s).	8617.800	8617.810	8617.830	996
LED system light		see page	see page	see page	1014
Earth straps		see page	see page	see page	1033
		8619.800	8619.801	8619.803	1044
Cable entry plates					
	Packs of	2 pc(s).	2 pc(s).	4 pc(s).	
Cable entry grommets	8 cables, max. Ø 13 mm	25 pc(s).	4316.000	4316.000	4316.000
	3 cables, max. Ø 21 mm	25 pc(s).	4317.000	4317.000	4317.000
	1 cable, max. Ø 47 mm	25 pc(s).	4318.000	4318.000	4318.000
Connector grommets	10 pc(s).	4311.000	4311.000	4311.000	1044
Section for cable entry, centre					
	Packs of	2 pc(s).	2 pc(s).	4 pc(s).	
Section for cable entry, rear		8618.800	8618.801	8618.803	1045
	Packs of	2 pc(s).	2 pc(s).	4 pc(s).	
Cable duct		see page	see page	see page	1058
Cable clamp rail, right angle section	2 pc(s).	8619.410	8619.420	8619.440	1059

Baying enclosure system VX25

Basic enclosure, height 2200 mm, depth 600 mm

Width (B) mm	Packs of	600	800	1200	Page	
Height (H) mm		2200	2200	2200		
Depth (T) mm		600	600	600		
Mounting plate width (F) mm		499	699	1099		
Mounting plate height (G) mm		2096	2096	2096		
Model No.	1 pc(s).	8626.000	8826.000	8226.000		
Weight kg		106.0	136.0	204.0		
Product-specific scope of supply						
Door(s)		1	1	2		
Accessories						
Base/plinth corner pieces with base/plinth trim panels, front and rear, 100 mm	2 pc(s).	8640.002	8640.003	8640.007	881	
Base/plinth trim panels, sides, 100 mm	2 pc(s).	8640.033	8640.033	8640.033	882	
Base/plinth corner pieces with base/plinth trim panels, front and rear, 200 mm	2 pc(s).	8640.022	8640.023	8640.025	881	
Base/plinth trim panels, sides, 200 mm	2 pc(s).	8640.043	8640.043	8640.043	882	
Levelling feet	4 pc(s).	4612.000	4612.000	4612.000	892	
Side panels, screw-fastened, sheet steel	2 pc(s).	8126.245	8126.245	8126.245	901	
Divider panel	1 pc(s).	8609.207	8609.207	8609.207	905	
Divider panel for module plates		–	–	–		
Baying bracket, internal	6 pc(s).	8617.500	8617.500	8617.500	912	
Baying block, internal	6 pc(s).	8617.501	8617.501	8617.501	912	
Baying connector, external	6 pc(s).	8617.502	8617.502	8617.502	912	
Glazed door	1 pc(s).	8618.040	8618.050	–	917	
Comfort handle VX for lock inserts	1 pc(s).	8618.200	8618.200	8618.200	937	
Comfort handle VX for lock inserts and padlock	1 pc(s).	8618.230	8618.230	8618.230	937	
Comfort handle VX for profile half-cylinders	1 pc(s).	8618.250	8618.250	8618.250	937	
Comfort handle VX with security lock insert, lock E1	1 pc(s).	8618.240	8618.240	8618.240	937	
Comfort handle VX for ASSA lock system	1 pc(s).	8618.270	8618.270	8618.270	937	
Lock inserts		see page	see page	see page	941, 942	
180° hinges	4 pc(s).	8618.330	8618.330	8618.330	951	
Punched section with mounting flange, 14 x 39 mm, for tubular door frame	4 pc(s).	8619.720	8619.730	8619.720	952	
Wiring plan pocket, sheet steel, depth 35 mm	1 pc(s).	4116.500	4118.500	4116.500	955	
Wiring plan pocket, sheet steel, depth 90 mm	1 pc(s).	4116.000	4118.000	4116.000	955	
Door stay	1 pc(s).	8618.430	8618.430	8618.430	956	
Door stay for escape routes	1 pc(s).	8618.425	8618.425	8618.425	956	
Ride-up roller	10 pc(s).	8618.420	8618.420	8618.420	956	
Mounting plate infill	1 pc(s).	4592.700	4592.700	4592.700	971	
Punched section with mounting flange 18 x 64 mm for the outer level, in the width	4 pc(s).	8617.030	8617.040	8617.060	990	
Punched section with mounting flange 18 x 64 mm for the outer level, in the depth	4 pc(s).	8617.030	8617.030	8617.030	990	
Punched section with mounting flange 23 x 64 mm for the inner level, in the width	4 pc(s).	8617.130	8617.140	8617.160	991	
Punched section with mounting flange 23 x 64 mm for the inner level, in the depth	4 pc(s).	8617.130	8617.130	8617.130	991	
Punched rail 18 x 39 mm for the enclosure depth	4 pc(s).	8617.720	8617.720	8617.720	993	
Support strip for the enclosure depth	20 pc(s).	4696.000	4696.000	4696.000	994	
C rail 30/15, for the enclosure width	6 pc(s).	4944.000	4945.000	4947.000	996	
Support rail 48 x 26 mm, for the enclosure width	2 pc(s).	8617.800	8617.810	8617.830	996	
LED system light		see page	see page	see page	1014	
Earth straps		see page	see page	see page	1033	
Cable entry plates		8619.800	8619.801	8619.803	1044	
	Packs of	2 pc(s).	2 pc(s).	4 pc(s).		
Cable entry grommets	8 cables, max. Ø 13 mm	25 pc(s).	4316.000	4316.000	4316.000	1044
	3 cables, max. Ø 21 mm	25 pc(s).	4317.000	4317.000	4317.000	1044
	1 cable, max. Ø 47 mm	25 pc(s).	4318.000	4318.000	4318.000	1044
Connector grommets	10 pc(s).	4311.000	4311.000	4311.000	1044	
Section for cable entry, centre		8618.800	8618.801	8618.803	1045	
	Packs of	2 pc(s).	2 pc(s).	4 pc(s).		
Section for cable entry, rear		8618.810	8618.811	8618.813	1045	
	Packs of	2 pc(s).	2 pc(s).	4 pc(s).		
Cable duct		see page	see page	see page	1058	
Cable clamp rail, right angle section	2 pc(s).	8619.410	8619.420	8619.440	1059	

Baying enclosure system VX25



System accessories Page 877 **VX25 basic enclosure** Page 116 **VX25 stainless steel** Page 242 **VX25 EMC-shielded** Page 136

Material and surface finish:

- Enclosure frame: Sheet steel, 1.5 mm, dipcoat-primed
- Roof: Sheet steel, 1.5 mm, dipcoat-primed, powder-coated on the outside, textured paint
- Glazed door: Extruded aluminium section, powder-coated, single-pane safety glass, 3 mm
- Rear door: Sheet steel, 2 mm, dipcoat-primed, powder-coated on the outside, textured paint
- Gland plates: Sheet steel, 1.5 mm, zinc-plated, passivated

Colour:

- Enclosure frame, door frame, corner pieces, panels: RAL 7035
- Viewing window (printed mask on the inside): RAL 9005

Protection category IP to IEC 60 529:

- IP 55

Protection category NEMA:

- NEMA 12

Supply includes:

- Enclosure frame
- Door(s) (r/h hinge, may be swapped to opposite side)
- Roof plate
- Glazed door at front
- Rear door
- Gland plates
- Lock: 3 mm double-bit

Approvals:

- UL
- cUL
- CSA

Further approvals can be found on the Internet.

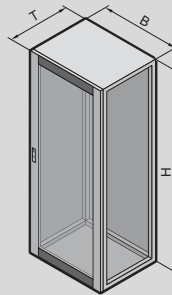

Baying enclosure system VX25

Basic enclosure with glazed door

Width (B) mm	Packs of	600	600	800	800	Page
Height (H) mm		2000	2000	2000	2000	
Depth (T) mm		600	800	600	800	
Model No.	1 pc(s).	8840.120	8840.130	8840.100	8840.110	
Weight kg		71.0	75.4	84.2	90.0	
Accessories						
Base/plinth corner pieces with base/plinth trim panels, front and rear, 100 mm	2 pc(s).	8640.002	8640.002	8640.003	8640.003	881
Base/plinth trim panels, sides, 100 mm	2 pc(s).	8640.033	8640.034	8640.033	8640.034	882
Base/plinth corner pieces with base/plinth trim panels, front and rear, 200 mm	2 pc(s).	8640.022	8640.022	8640.023	8640.023	881
Base/plinth trim panels, sides, 200 mm	2 pc(s).	8640.043	8640.044	8640.043	8640.044	882
Levelling feet	4 pc(s).	4612.000	4612.000	4612.000	4612.000	892
Side panels, screw-fastened, sheet steel	2 pc(s).	8106.245	8108.245	8106.245	8108.245	901
Divider panel	1 pc(s).	8609.205	8609.206	8609.205	8609.206	905
Divider panel for module plates	1 pc(s).	8609.213	–	8609.213	–	906
Baying bracket, internal	6 pc(s).	8617.500	8617.500	8617.500	8617.500	912
Baying block, internal	6 pc(s).	8617.501	8617.501	8617.501	8617.501	912
Baying connector, external	6 pc(s).	8617.502	8617.502	8617.502	8617.502	912
Comfort handle VX for lock inserts	1 pc(s).	8618.200	8618.200	8618.200	8618.200	937
Comfort handle VX for lock inserts and padlock	1 pc(s).	8618.230	8618.230	8618.230	8618.230	937
Comfort handle VX for profile half-cylinders	1 pc(s).	8618.250	8618.250	8618.250	8618.250	937
Comfort handle VX with security lock insert, lock E1	1 pc(s).	8618.240	8618.240	8618.240	8618.240	937
Comfort handle VX for ASSA lock system	1 pc(s).	8618.270	8618.270	8618.270	8618.270	937
Lock inserts		see page	see page	see page	see page	941, 942
180° hinges	4 pc(s).	8618.330	8618.330	8618.330	8618.330	951
Punched section with mounting flange, 14 x 39 mm, for tubular door frame	4 pc(s).	8619.720	8619.720	8619.730	8619.730	952
Wiring plan pocket, sheet steel, depth 35 mm	1 pc(s).	4116.500	4116.500	4118.500	4118.500	955
Wiring plan pocket, sheet steel, depth 90 mm	1 pc(s).	4116.000	4116.000	4118.000	4118.000	955
Door stay	1 pc(s).	8618.430	8618.430	8618.430	8618.430	956
Door stay for escape routes	1 pc(s).	8618.425	8618.425	8618.425	8618.425	956
Ride-up roller	10 pc(s).	8618.420	8618.420	8618.420	8618.420	956
Punched section with mounting flange 18 x 64 mm for the outer level, in the width	4 pc(s).	8617.030	8617.030	8617.040	8617.040	990
Punched section with mounting flange 18 x 64 mm for the outer level, in the depth	4 pc(s).	8617.030	8617.040	8617.030	8617.040	990
Punched section with mounting flange 23 x 64 mm for the inner level, in the width	4 pc(s).	8617.130	8617.130	8617.140	8617.140	991
Punched section with mounting flange 23 x 64 mm for the inner level, in the depth	4 pc(s).	8617.130	8617.140	8617.130	8617.140	991
Punched rail 18 x 39 mm for the enclosure depth	4 pc(s).	8617.720	8617.730	8617.720	8617.730	993
Support strip for the enclosure depth	20 pc(s).	4696.000	4697.000	4696.000	4697.000	994
C rail 30/15, for the enclosure width	6 pc(s).	4944.000	4944.000	4945.000	4945.000	996
Support rail 48 x 26 mm, for the enclosure width	2 pc(s).	8617.800	8617.800	8617.810	8617.810	996
LED system light		see page	see page	see page	see page	1014
Earth straps		see page	see page	see page	see page	1033
Cable entry plates		8619.800	8619.800	8619.801	8619.801	1044
	Packs of	2 pc(s).	2 pc(s).	2 pc(s).	2 pc(s).	
Cable entry grommets	8 cables, max. Ø 13 mm	25 pc(s).	4316.000	4316.000	4316.000	1044
	3 cables, max. Ø 21 mm	25 pc(s).	4317.000	4317.000	4317.000	1044
	1 cable, max. Ø 47 mm	25 pc(s).	4318.000	4318.000	4318.000	1044
Connector grommets	10 pc(s).	4311.000	4311.000	4311.000	4311.000	1044
Section for cable entry, centre		8618.800	8618.800	8618.801	8618.801	1045
	Packs of	2 pc(s).	2 pc(s).	2 pc(s).	2 pc(s).	
Section for cable entry, rear		8618.810	8618.810	8618.811	8618.811	1045
	Packs of	2 pc(s).	2 pc(s).	2 pc(s).	2 pc(s).	
Cable clamp rail, right angle section	2 pc(s).	8619.410	8619.410	8619.420	8619.420	1059

Baying enclosure system VX25



System accessories Page 877 482.6 mm (19") installation accessories Page 1075 482.6 mm (19") climate control Page 466

Material and surface finish:

- Enclosure frame: Sheet steel, 1.5 mm, dipcoat-primed
- Roof: Sheet steel, 1.5 mm, dipcoat-primed, powder-coated on the outside, textured paint
- Front frame: Extruded aluminium section, powder-coated

- Rear door: Sheet steel, 2 mm, dipcoat-primed, powder-coated on the outside, textured paint
- Gland plates: Sheet steel, 1.5 mm, zinc-plated, passivated
- 482.6 mm (19") adaptor sections: Sheet steel, zinc-plated

Colour:

- RAL 7035

Supply includes:

- Enclosure frame
- Front frame (r/h hinge, held on the left via magnetic snap fasteners)
- Rear door (r/h hinge, may be swapped to opposite side)
- Roof plate
- Gland plates
- Adaptor sections, 482.6 mm (19"), front

Electronic enclosure

Height units U	Packs of	33	33	42	42	Page
Width mm		600	600	600	600	
Height mm		1600	1600	2000	2000	
Depth mm		600	800	600	800	
Model No.	1 pc(s).	8410.000	8418.000	8430.000	8438.000	
Weight kg		58.0	63.2	67.8	72.2	

Accessories

Base/plinth corner pieces with base/plinth trim panels, front and rear, 100 mm	2 pc(s).	8640.002	8640.002	8640.002	8640.002	881
Base/plinth trim panels, sides, 100 mm	2 pc(s).	8640.033	8640.034	8640.033	8640.034	882
Base/plinth corner pieces with base/plinth trim panels, front and rear, 200 mm	2 pc(s).	8640.022	8640.022	8640.022	8640.022	881
Base/plinth trim panels, sides, 200 mm	2 pc(s).	8640.043	8640.044	8640.043	8640.044	882
Levelling feet	4 pc(s).	4612.000	4612.000	4612.000	4612.000	892
Side panels, screw-fastened, sheet steel	2 pc(s).	8166.245	8168.245	8106.245	8108.245	901
Comfort handle VX for lock inserts	1 pc(s).	8618.200	8618.200	8618.200	8618.200	937
Comfort handle VX for lock inserts and padlock	1 pc(s).	8618.230	8618.230	8618.230	8618.230	937
Comfort handle VX for profile half-cylinders	1 pc(s).	8618.250	8618.250	8618.250	8618.250	937
Lock inserts		see page	see page	see page	see page	941, 942
Punched section with mounting flange 18 x 64 mm for the outer level, in the depth	4 pc(s).	8617.030	8617.040	8617.030	8617.040	990
LED system light		see page	see page	see page	see page	1014
Section for cable entry, centre	2 pc(s).	8618.800	8618.800	8618.800	8618.800	1045
Section for cable entry, rear	2 pc(s).	8618.810	8618.810	8618.810	8618.810	1045
Cable clamp rail, right angle section	2 pc(s).	8619.410	8619.410	8619.410	8619.410	1059
Adaptor section, 482.6 mm (19")	2 pc(s).	8619.300	8619.300	8619.320	8619.320	1080
Adaptor piece, 482.6 mm (19")	4 pc(s).	8619.330	8619.330	8619.330	8619.330	1081
Slide rail with two-sided mounting	10 pc(s).	8613.161	8613.181	8613.161	8613.181	1089
Slide rail with one-sided mounting	10 pc(s).	4531.001	4531.001	4531.001	4531.001	1089
482.6 mm (19") fastener, 1 U	24 pc(s).	2090.000	2090.000	2090.000	2090.000	1097

Baying enclosure system VX25



System accessories Page 877 **Cable entry** Page 1044

Material and surface finish:

- Enclosure frame: Sheet steel, 1.5 mm, dipcoat-primed and powder-coated, textured paint
- Roof: Sheet steel, 1.5 mm, dipcoat-primed and powder-coated, textured paint
- Door: Sheet steel, 2 mm, dipcoat-primed and powder-coated, textured paint
- Rear panel: Sheet steel, 1.5 mm, dipcoat-primed and powder-coated, textured paint
- Gland plate: Sheet steel, 1.5 mm, dipcoat-primed and powder-coated, textured paint
- Mounting plate: Sheet steel, 3 mm, zinc-plated, passivated

Colour:

- RAL 7035

Protection category IP to IEC 60 529:

- IP 66

Protection category NEMA:

- NEMA 4

Supply includes:

- Enclosure frame
- Door (r/h hinge, may be swapped to opposite side)
- Roof plate
- Base
- Rear panel
- Mounting plate
- Lock: 3 mm double-bit
- 2 punched rails 18 x 39 mm
- Accessory kit for side panels for upgrading to IP 66/NEMA 4

Note:

- The standard baying connectors VX for bayed suites may be used while maintaining the protection category IP 66/NEMA 4X

Approvals:

- UL
- cUL
- DNV-GL

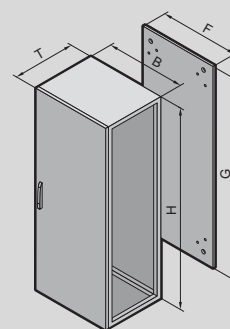

IP 66/NEMA 4

Width (B) mm	Packs of	800	Page
Height (H) mm		2000	
Depth (T) mm		600	
Mounting plate width (F) mm		699	
Mounting plate height (G) mm		1896	
Model No.	1 pc(s).	8807.000	
Accessories			
Base/plinth corner pieces with base/plinth trim panels, front and rear, 100 mm	2 pc(s).	8640.003	881
Base/plinth trim panels, sides, 100 mm	2 pc(s).	8640.033	882
Base/plinth corner pieces with base/plinth trim panels, front and rear, 200 mm	2 pc(s).	8640.023	881
Base/plinth trim panels, sides, 200 mm	2 pc(s).	8640.043	882
Levelling feet	4 pc(s).	4612.000	892
Side panels, screw-fastened, sheet steel	2 pc(s).	8106.245	901
Baying bracket, internal	6 pc(s).	8617.500	912
Baying block, internal	6 pc(s).	8617.501	912
Baying connector, external	6 pc(s).	8617.502	912
Comfort handle VX for lock inserts	1 pc(s).	8618.200	937
Comfort handle VX for profile half-cylinders	1 pc(s).	8618.250	937
Wiring plan pocket, sheet steel, depth 35 mm	1 pc(s).	4118.500	955
Wiring plan pocket, sheet steel, depth 90 mm	1 pc(s).	4118.000	955
LED system light		see page	1014
Cable duct		see page	1058
Cable clamp rail, right angle section	2 pc(s).	8619.420	1059

Baying enclosure system VX25



System accessories Page 877 Modular front design Page 925 Compartment configuration Page 410

Material and surface finish:

- Enclosure frame: Sheet steel, 1.5 mm, dipcoat-primed
- Rear panel: Sheet steel, 1.5 mm, dipcoat-primed, powder-coated on the outside, textured paint
- Gland plates: Sheet steel, 1.5 mm, zinc-plated

Colour:

- RAL 7035

Basis of test:

- IEC 61 439-1/-2
- IEC 61 641

Protection category IP to IEC 60 529:

- Up to IP 54, depending on the panels

Supply includes:

- Enclosure frame
- Rear panel
- Gland plates

Modular enclosure, height 2000 mm

Width mm	Packs of	400	600	800	400	600	800	Page
Height mm		2000	2000	2000	2000	2000	2000	
Depth mm		600	600	600	800	800	800	
Model No.	1 pc(s).	9680.406	9680.606	9680.806	9680.408	9680.608	9680.808	
Weight kg		43.8	51.0	61.0	46.0	53.7	64.2	

Accessories

Base/plinth corner pieces with base/plinth trim panels, front and rear, 100 mm	2 pc(s).	8640.001	8640.002	8640.003	8640.001	8640.002	8640.003	881
Base/plinth trim panels, sides, 100 mm	2 pc(s).	8640.033	8640.033	8640.033	8640.034	8640.034	8640.034	882
Base/plinth corner pieces with base/plinth trim panels, front and rear, 200 mm	2 pc(s).	8640.021	8640.022	8640.023	8640.021	8640.022	8640.023	881
Base/plinth trim panels, sides, 200 mm	2 pc(s).	8640.043	8640.043	8640.043	8640.044	8640.044	8640.044	882
Side panel, screw-fastened, sheet steel	2 pc(s).	8106.245	8106.245	8106.245	8106.245	8108.245	8108.245	901
Baying bracket, internal	6 pc(s).	8617.500	8617.500	8617.500	8617.500	8617.500	8617.500	912
Baying block, internal	6 pc(s).	8617.501	8617.501	8617.501	8617.501	8617.501	8617.501	912
Baying connector, external	6 pc(s).	8617.502	8617.502	8617.502	8617.502	8617.502	8617.502	912
Partial door		see page	see page	see page	see page	see page	see page	926
Front trim panel, top, solid		see page	see page	see page	see page	see page	see page	927
Front trim panel, bottom, solid		see page	see page	see page	see page	see page	see page	927
Front trim panel, bottom, vented	1 pc(s).	9682.354	9682.356	9682.358	9682.354	9682.356	9682.358	927
Roof plate IP 55, solid	1 pc(s).	9681.646	9681.666	9681.686	9681.648	9681.668	9681.688	961
Roof plate IP 2X with ventilation hole	1 pc(s).	9681.846	9681.866	9681.886	9681.848	9681.868	9681.888	961
Roof plate for cable entry glands	1 pc(s).	9681.546	9681.566	9681.586	9681.548	9681.568	9681.588	961
Cable entry gland		see page	see page	see page	see page	see page	see page	962

Baying enclosure system VX25

Modular enclosure, height 2200 mm

Width mm	Packs of	400	600	800	400	600	800	Page
Height mm		2200	2200	2200	2200	2200	2200	
Depth mm		600	600	600	800	800	800	
Model No.	1 pc(s).	9680.426	9680.626	9680.826	9680.428	9680.628	9680.828	
Weight kg		43.2	54.0	59.4	46.1	55.8	66.0	
Accessories								
Base/plinth corner pieces with base/plinth trim panels, front and rear, 100 mm	2 pc(s).	8640.001	8640.002	8640.003	8640.001	8640.002	8640.003	881
Base/plinth trim panels, sides, 100 mm	2 pc(s).	8640.033	8640.033	8640.033	8640.034	8640.034	8640.034	882
Base/plinth corner pieces with base/plinth trim panels, front and rear, 200 mm	2 pc(s).	8640.021	8640.022	8640.023	8640.021	8640.022	8640.023	881
Base/plinth trim panels, sides, 200 mm	2 pc(s).	8640.043	8640.043	8640.043	8640.044	8640.044	8640.044	882
Side panel, screw-fastened, sheet steel	2 pc(s).	8126.245	8126.245	8126.245	8128.245	8128.245	8128.245	901
Baying bracket, internal	6 pc(s).	8617.500	8617.500	8617.500	8617.500	8617.500	8617.500	912
Baying block, internal	6 pc(s).	8617.501	8617.501	8617.501	8617.501	8617.501	8617.501	912
Baying connector, external	6 pc(s).	8617.502	8617.502	8617.502	8617.502	8617.502	8617.502	912
Partial door		see page	see page	see page	see page	see page	see page	926
Front trim panel, top, solid		see page	see page	see page	see page	see page	see page	927
Front trim panel, bottom, solid		see page	see page	see page	see page	see page	see page	927
Front trim panel, bottom, vented	1 pc(s).	9682.354	9682.356	9682.358	9682.354	9682.356	9682.358	927
Roof plate IP 55, solid	1 pc(s).	9681.646	9681.666	9681.686	9681.648	9681.668	9681.688	961
Roof plate IP 2X with ventilation hole	1 pc(s).	9681.846	9681.866	9681.886	9681.848	9681.868	9681.888	961
Roof plate for cable entry glands	1 pc(s).	9681.546	9681.566	9681.586	9681.548	9681.568	9681.588	961
Cable entry gland		see page	see page	see page	see page	see page	see page	962



Rittal – The System.

Modular front design

see page 925

Baying enclosure system VX25



System accessories Page 877 Compartment configuration Page 410 Fuse-switch disconnecter section Page 415

Material and surface finish:

- Enclosure frame: Sheet steel, 1.5 mm, dipcoat-primed
- Roof: Sheet steel, 1.5 mm, dipcoat-primed, powder-coated on the outside, textured paint
- Door: Sheet steel, 2 mm, dipcoat-primed, powder-coated on the outside, textured paint
- Rear panel: Sheet steel, 1.5 mm, dipcoat-primed, powder-coated on the outside, textured paint
- Gland plate: Sheet steel, 1.5 mm, zinc-plated
- Front trim panel: Sheet steel, 1.5 mm, dipcoat-primed, powder-coated on the outside, textured paint
- Compartment side panel: Sheet steel, 1.5 mm, zinc-plated

Colour:

- RAL 7035

Basis of test:

- IEC 61 439-1/-2
- IEC 61 641

Protection category IP to IEC 60 529:

- Up to IP 3X, depending on the panels

Supply includes:

- Enclosure frame
- Door
- Roof plate
- Rear panel
- Gland plates
- Front trim panels
- Lock: 3 mm double-bit
- Compartment side panels
- Locating frame for disconnectors with fuses (brands ABB SlimLine/Jean Müller SASIL)

Fuse-switch-disconnector enclosure, height 2000 – 2200 mm

Width mm	Packs of	1000	1200	1000	1200	Page
Height mm		2000	2000	2200	2200	
Depth mm		600	800	600	800	
Model No.	1 pc(s).	9680.005	9680.207	9680.025	9680.227	
Weight kg		125.3	149.6	135.2	158.9	

Accessories

Base/plinth corner pieces with base/plinth trim panels, front and rear, 100 mm	2 pc(s).	8640.005	8640.007	8640.005	8640.007	881
Base/plinth trim panels, sides, 100 mm	2 pc(s).	8640.033	8640.034	8640.033	8640.034	882
Base/plinth corner pieces with base/plinth trim panels, front and rear, 200 mm	2 pc(s).	8640.024	8640.025	8640.024	8640.025	881
Base/plinth trim panels, sides, 200 mm	2 pc(s).	8640.043	8640.044	8640.043	8640.044	882
Side panel, screw-fastened, sheet steel	2 pc(s).	8106.245	8108.245	8126.245	8128.245	901
Baying bracket, internal	6 pc(s).	8617.500	8617.500	8617.500	8617.500	912
Baying block, internal	6 pc(s).	8617.501	8617.501	8617.501	8617.501	912
Baying connector, external	6 pc(s).	8617.502	8617.502	8617.502	8617.502	912
Roof plate IP 2X with ventilation hole	1 pc(s).	9681.806	9681.828	9681.806	9681.828	961

Baying enclosure system VX25



System accessories Page 877 **ISV assembly modules** Page 421 **VX basic enclosure** Page 116 **Lock systems** Page 937

Material and surface finish:

- Enclosure frame: Sheet steel, 1.5 mm, dipcoat-primed
- Roof: Sheet steel, 1.5 mm, dipcoat-primed, powder-coated on the outside, textured paint
- Door: Sheet steel, 2 mm, dipcoat-primed, powder-coated on the outside, textured paint
- Rear panel: Sheet steel, 1.5 mm, dipcoat-primed, powder-coated on the outside, textured paint
- Gland plates: Sheet steel, 1.5 mm, zinc-plated

Colour:

- RAL 7035

Basis of test:

- IEC 61 439-1/-2

Protection category IP to IEC 60 529:

- IP 55

Protection category NEMA:

- NEMA 12

Supply includes:

- Enclosure frame
 - Door(s) (door hinged on the right, may be swapped to the left)
 - Gland plates
 - Rear panel
 - Roof plate
 - Lock: 3 mm double-bit
- Please observe the product-specific scope of supply.

Note:

- For 600 mm wide distribution enclosures, please use VX basic enclosures
- For a base/plinth height of 200 mm, 2 packs each of plinth corner pieces, 100 mm and base/plinth trim panels, 100 mm are required

Distribution enclosure

	Packs of	850	1100	850	1100	Page
Width mm						
Height mm		2000	2000	2000	2000	
Depth mm		400	400	600	600	
Model No.	1 pc(s).	9666.956	9666.966	9666.916	9666.926	
Weight kg		111.0	146.0	117.0	156.0	
Product-specific scope of supply						
Number of doors		1	2	1	2	
Also required						
ISV installation kit	1 pc(s).	9666.912	9666.922	9666.912	9666.922	420
Mounting angles ISV	2 pc(s).	9666.712	9666.712	9666.712	9666.712	429
Depth stay for installation kit ISV	2 pc(s).	-	9666.732	-	9666.732	430
Accessories						
Base/plinth corner pieces with base/plinth trim panels, front and rear, 100 mm	2 pc(s).	8640.004	8640.006	8640.004	8640.006	881
Base/plinth trim panels, sides, 100 mm	2 pc(s).	8640.031	8640.031	8640.033	8640.033	882
Side panel, screw-fastened, sheet steel	2 pc(s).	8104.245	8104.245	8106.245	8106.245	901
Baying bracket, internal	6 pc(s).	8617.500	8617.500	8617.500	8617.500	912
Baying block, internal	6 pc(s).	8617.501	8617.501	8617.501	8617.501	912
Baying connector, external	6 pc(s).	8617.502	8617.502	8617.502	8617.502	912
Roof plate for cable entry glands	1 pc(s).	9681.594	9681.514	9681.596	9681.516	961
Cable entry gland		see page	see page	see page	see page	962

Baying enclosure system VX25



System accessories Page 877 **VX25 basic enclosure** Page 116 **VX25 stainless steel** Page 242

The large enclosures in the VX25 series offer a good level of shielding across a broad frequency range, even in the standard version. For increased EMC requirements, Rittal's VX25 enclosure is also available in a high RF attenuation version.

Material and surface finish:

- Enclosure frame: Sheet steel, 1.5 mm, with magnesium zinc coating
- Roof: Sheet steel, 1.5 mm, with magnesium zinc coating, spray-finished on the outside and paint-free on the inside

- Door: Sheet steel, 2 mm, with magnesium zinc coating, spray-finished on the outside and paint-free on the inside
- Rear panel: Sheet steel, 1.5 mm, with magnesium zinc coating, spray-finished on the outside and paint-free on the inside
- Gland plates: Sheet steel, 1.5 mm, zinc-plated
- Mounting plate: Sheet steel, 3 mm, zinc-plated

Colour:

- RAL 7035

Protection category IP to IEC 60 529:

- IP 55

NEMA protection category:

- NEMA 12

Supply includes:

- Enclosure frame
- Door(s) (door hinged on the right, may be swapped to the left)
- Rear panel
- Roof plate
- Gland plates
- Mounting plate
- Lock: 3 mm double-bit
- 2 punched rails 18 x 39 mm

Note:

- For bayed enclosures, the EMC shielding seal is required

Approvals:

- UL
- cUL

Further approvals can be found on the Internet.

EMC enclosure

Width mm	Packs of	800	800	Page
Height mm		2000	2000	
Depth mm		600	800	
Model No.	1 pc(s).	8807.010	8807.020	
Weight kg		130.0	135.0	

Accessories				
Base/plinth corner pieces with base/plinth trim panels, front and rear, 100 mm	2 pc(s).	8640.003	8640.003	881
Base/plinth trim panels, sides, 100 mm	2 pc(s).	8640.033	8640.034	882
Base/plinth corner pieces with base/plinth trim panels, front and rear, 200 mm	2 pc(s).	8640.023	8640.023	881
Base/plinth trim panels, sides, 200 mm	2 pc(s).	8640.043	8640.044	882
EMC side panels	2 pc(s).	8106.760	8108.760	1028
EMC shielding seal	1 pc(s).	8800.695	8800.695	1028
Divider panel	1 pc(s).	8609.205	8609.206	905
EMC divider panel seal	1 pc(s).	4348.500	4348.500	1028
Rail for EMC shielding bracket	1 pc(s).	2388.850	2388.850	1029
EMC shielding bracket		see page	see page	1029
EMC shield bus		see page	see page	1030
EMC gland plates	1 pc(s).	8618.821	8618.821	1029
EMC earth clamps		see page	see page	1030
EMC cable glands		see page	see page	1030
Cable duct		see page	see page	1058
LED system light		see page	see page	1014
Earth strap		see page	see page	1033
Earthing braid		see page	see page	1033
Comfort handle VX		see page	see page	937

LED system light

Innovative LED technology produces even more light,
see page 1012



Free-standing enclosure system VX SE

Added efficiency with planning and assembly



Digitalization

- The QR code on all machinable enclosure panels permits fully automated incorporation into the production workflow, for seamless digital monitoring from the incoming goods right through to the finished product.

Reliable engineering

- In the automated production process and when working with virtual prototypes, Rittal supports its customers with a host of conversion and planning tools:
 - Configurators
 - Parts list converters
 - EPLAN Pro Panel
 - 2D/3D CAD data
 - ecl@ss Advanced
 - Technical documentation
 - Data for planners

Large variety of sizes

- Enclosure widths from 600 – 1800 mm
- Widths 1600 and 1800 mm are only available for VX SE. These replace several bayed enclosures.

Benefits:

- No baying work
- One large, continuous mounting plate
- Savings on accessories:
 - Only one base/plinth
 - Only one handle
- No need to use a mounting plate infill
- 300 mm deep enclosures are ideal for use in facility management

Smart construction

- High stability thanks to a self-supporting, integral construction technique, with roof and sides from a single piece with roll-formed frame
- High protection category up to IP 66
- A wide range of sheet steel and stainless steel versions for almost any application area
- 300 mm deep enclosures are ideal for use in facility management



Free-standing enclosure system VX SE

Compatibility with the VX25 for added efficiency in interior installation, even more efficient



Compatible interior installation

- With the new base assembly and optional adaptor rail, interior installation is compatible with the VX25
- All VX25 punched sections and bars for the inner mounting level may be used without restriction
- The large swing frame supports full or partial installation for 482.6 mm (19") components. It is fully depth-adjustable within the 25 mm pitch pattern, and hinged on the left or right. Two swing frames may also be fitted together in 1200 mm wide enclosures.

Optimum installation options

- The continuous square holes on the vertical section when using adaptor rail VX support the use of metric screw-fastenings M5, M6, M8

System benefits

- The smart enclosure design from a single piece eliminates the need for additional earth straps from the roof and side panels to the frame
- Automatic potential equalisation from the rear panel to the enclosure as standard
- When using a Rittal climate control device and Rittal fan-and-filter unit in the roof, rear panel and side panels, additional earthing is not required
- The smart enclosure design from a single piece ensures good EMC properties

Simple cable entry

- The blunt edges minimise the risk of cable damage when routing cables underneath the enclosure
- The earthing points pre-labelled as standard provide quick guidance and help to accelerate the work process
- The double edge fold of the gland plates prevents bending even under heavy loads to ensure compliance with the high protection category

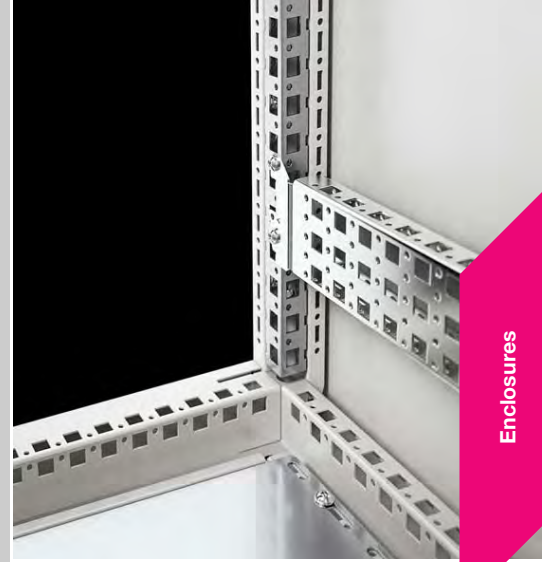

Free-standing enclosure system VX SE



System accessories Page 877 VX SE stainless steel Page 248 Base/plinth Page 880

Material and surface finish:

- Enclosure: Sheet steel, 1.5 mm, dipcoat-primed, powder-coated on the outside, textured paint
- Door: Sheet steel, 2 mm, dipcoat-primed, powder-coated on the outside, textured paint
- Rear panel: Sheet steel, 1.5 mm, dipcoat-primed, powder-coated on the outside, textured paint
- Mounting plate: Sheet steel, 3 mm, zinc-plated, passivated
- Gland plates: Sheet steel, 1.5 mm, zinc-plated, passivated

Colour:

- RAL 7035

Protection category IP to IEC 60 529:

- IP 55

Protection category NEMA:

- NEMA 12

Supply includes:

- Enclosure, solid top and sides
- Door(s)
- R/h door hinge with single-door enclosures, may be swapped to opposite side
- Mounting plate
- Gland plates
- Rear panel, detachable
- Lock: 3 mm double-bit
- 2 punched rails 18 x 39 mm

Please note the product-specific scope of supply.

Approvals:

- UL
- cUL

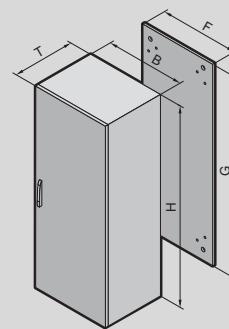

Free-standing enclosure system VX SE

Basic enclosure, width 600 mm

Width (B) mm	Packs of	600	600	600	Page	
Height (H) mm		1800	1800	2000		
Depth (T) mm		300	400	300		
Mounting plate width (F) mm		499	499	499		
Mounting plate height (G) mm		1696	1696	1896		
Model No.	1 pc(s).	5820.600	5830.600	5821.600		
Product-specific scope of supply						
Rear panel, one-piece		■	■	■		
Door(s)		1	1	1		
Accessories						
Base/plinth corner pieces with base/plinth trim panels, front and rear, 100 mm	2 pc(s).	8640.002	8640.002	8640.002	881	
Base/plinth trim panels, sides, 100 mm	2 pc(s).	8640.030	8640.031	8640.030	882	
Base/plinth corner pieces with base/plinth trim panels, front and rear, 200 mm	2 pc(s).	8640.022	8640.022	8640.022	881	
Base/plinth trim panels, sides, 200 mm	2 pc(s).	8640.040	8640.041	8640.040	882	
Levelling feet	4 pc(s).	4612.000	4612.000	4612.000	892	
Glazed door	1 pc(s).	8610.685	8610.685	8610.605	918	
Comfort handle for lock insert	1 pc(s).	8611.020	8611.020	8611.020	938	
Comfort handle for lock insert and padlock	1 pc(s).	8611.290	8611.290	8611.290	938	
Comfort handle for profile half-cylinders	1 pc(s).	8611.070	8611.070	8611.070	938	
Lock inserts		see page	see page	see page	941, 942	
180° hinges	4 pc(s).	8800.190	8800.190	8800.190	951	
Punched section with mounting flange, 14 x 39 mm, for door	4 pc(s).	8619.720	8619.720	8619.720	952	
Wiring plan pocket, depth 35 mm	1 pc(s).	4116.500	4116.500	4116.500	955	
Wiring plan pocket, depth 90 mm	1 pc(s).	4116.000	4116.000	4116.000	955	
Door stay	5 pc(s).	4583.000	4583.000	4583.000	956	
Door stay for escape routes	1 pc(s).	4583.500	4583.500	4583.500	956	
Ride-up roller	10 pc(s).	4538.000	4538.000	4538.000	956	
Adaptor rail VX to fit enclosure height	4 pc(s).	8617.750	8617.750	8617.751	995	
Punched section with mounting flange 17 x 73 mm for the inner level, in the depth	4 pc(s).	8612.030	8612.040	8612.030	992	
Punched section with mounting flange 17 x 73 mm for the outer level, in the depth	4 pc(s).	8612.130	8612.140	8612.130	992	
Punched section with mounting flange 23 x 64 mm for the inner level, in the depth ¹⁾	4 pc(s).	8617.100	8617.110	8617.100	991	
Punched section with mounting flange 23 x 64 mm for the inner level, in the width ¹⁾	4 pc(s).	8617.130	8617.130	8617.130	991	
Punched rail 18 x 39 mm for the enclosure depth ¹⁾	4 pc(s).	–	8617.700	–	993	
Support strip for the outer level for enclosure depth	20 pc(s).	–	4694.000	–	994	
Support strip for the inner level for enclosure depth	20 pc(s).	–	4309.000	–	994	
C rail 30/15, for the enclosure width	6 pc(s).	4944.000	4944.000	4944.000	996	
Support rail 48 x 26 mm, for the enclosure width ¹⁾	2 pc(s).	8617.800	8617.800	8617.800	996	
LED system light		see page	see page	see page	1014	
Earth straps		see page	see page	see page	1033	
Cable entry plate	2 pc(s).	8619.800	8619.800	8619.800	1044	
Cable entry grommets	8 cables, max. Ø 13 mm	25 pc(s).	4316.000	4316.000	4316.000	1044
	3 cables, max. Ø 21 mm	25 pc(s).	4317.000	4317.000	4317.000	1044
	1 cable, max. Ø 47 mm	25 pc(s).	4318.000	4318.000	4318.000	1044
Connector grommets	10 pc(s).	4311.000	4311.000	4311.000	1044	
Section for cable entry, centre	2 pc(s).	8618.800	8618.800	8618.800	1045	
Section for cable entry, rear	2 pc(s).	8618.810	8618.810	8618.810	1045	
Cable duct		see page	see page	see page	1058	
Cable clamp rail, right angle section	2 pc(s).	8619.410	8619.410	8619.410	1059	

¹⁾ The VX adaptor rail is required for installation in the vertical enclosure sections. Overview of VX SE compatible rail systems, see page 986

Free-standing enclosure system VX SE

Basic enclosure, width 800 mm

Width (B) mm	Packs of	800	800	800	800	800	800	Page
Height (H) mm		1800	1800	2000	2000	2000	2000	
Depth (T) mm		300	400	300	400	500	600	
Mounting plate width (F) mm		699	699	699	699	699	699	
Mounting plate height (G) mm		1696	1696	1896	1896	1896	1896	
Model No.	1 pc(s).	5822.600	5831.600	5823.600	5832.600	5833.600	5834.600	
Product-specific scope of supply								
Rear panel, one-piece		■	■	■	■	■	■	
Door(s)		1	1	1	1	1	1	
Accessories								
Base/plinth corner pieces with base/plinth trim panels, front and rear, 100 mm	2 pc(s).	8640.003	8640.003	8640.003	8640.003	8640.003	8640.003	881
Base/plinth trim panels, sides, 100 mm	2 pc(s).	8640.030	8640.031	8640.030	8640.031	8640.032	8640.033	882
Base/plinth corner pieces with base/plinth trim panels, front and rear, 200 mm	2 pc(s).	8640.023	8640.023	8640.023	8640.023	8640.023	8640.023	881
Base/plinth trim panels, sides, 200 mm	2 pc(s).	8640.040	8640.041	8640.040	8640.041	8640.042	8640.043	882
Levelling feet	4 pc(s).	4612.000	4612.000	4612.000	4612.000	4612.000	4612.000	892
Glazed door	1 pc(s).	8610.885	8610.885	8610.805	8610.805	8610.805	8610.805	918
Comfort handle for lock insert	1 pc(s).	8611.020	8611.020	8611.020	8611.020	8611.020	8611.020	938
Comfort handle for lock insert and padlock	1 pc(s).	8611.290	8611.290	8611.290	8611.290	8611.290	8611.290	938
Comfort handle for profile half-cylinders	1 pc(s).	8611.070	8611.070	8611.070	8611.070	8611.070	8611.070	938
Lock inserts		see page	see page	see page	see page	see page	see page	941, 942
180° hinges	4 pc(s).	8800.190	8800.190	8800.190	8800.190	8800.190	8800.190	951
Punched section with mounting flange, 14 x 39 mm, for door	4 pc(s).	8619.730	8619.730	8619.730	8619.730	8619.730	8619.730	952
Wiring plan pocket, depth 35 mm	1 pc(s).	4118.500	4118.500	4118.500	4118.500	4118.500	4118.500	955
Wiring plan pocket, depth 90 mm	1 pc(s).	4118.000	4118.000	4118.000	4118.000	4118.000	4118.000	955
Door stay	5 pc(s).	4583.000	4583.000	4583.000	4583.000	4583.000	4583.000	956
Door stay for escape routes	1 pc(s).	4583.500	4583.500	4583.500	4583.500	4583.500	4583.500	956
Ride-up roller	10 pc(s).	4538.000	4538.000	4538.000	4538.000	4538.000	4538.000	956
Adaptor rail VX to fit enclosure height	4 pc(s).	8617.750	8617.750	8617.751	8617.751	8617.751	8617.751	995
Punched section with mounting flange 17 x 73 mm for the inner level, in the depth	4 pc(s).	8612.030	8612.040	8612.030	8612.040	8612.050	8612.060	992
Punched section with mounting flange 17 x 73 mm for the outer level, in the depth	4 pc(s).	8612.130	8612.140	8612.130	8612.140	8612.150	8612.160	992
Punched section with mounting flange 23 x 64 mm for the inner level, in the depth ¹⁾	4 pc(s).	8617.100	8617.110	8617.100	8617.110	8617.120	8617.130	991
Punched section with mounting flange 23 x 64 mm for the inner level, in the width ¹⁾	4 pc(s).	8617.140	8617.140	8617.140	8617.140	8617.140	8617.140	991
Punched rail 18 x 39 mm for the enclosure depth ¹⁾	4 pc(s).	–	8617.700	–	8617.700	8617.710	8617.720	993
Support strip for the outer level for enclosure depth	20 pc(s).	–	4694.000	–	4694.000	4695.000	4696.000	994
Support strip for the inner level for enclosure depth	20 pc(s).	–	4309.000	–	4309.000	4596.000	8800.130	994
C rail 30/15, for the enclosure width	6 pc(s).	4945.000	4945.000	4945.000	4945.000	4945.000	4945.000	996
Support rail 48 x 26 mm, for the enclosure width ¹⁾	2 pc(s).	8617.810	8617.810	8617.810	8617.810	8617.810	8617.810	996
LED system light		see page	see page	see page	see page	see page	see page	1014
Earth straps		see page	see page	see page	see page	see page	see page	1033
Cable entry plate	2 pc(s).	8619.801	8619.801	8619.801	8619.801	8619.801	8619.801	1044
Cable entry grommets	8 cables, max. Ø 13 mm	25 pc(s).	4316.000	4316.000	4316.000	4316.000	4316.000	1044
	3 cables, max. Ø 21 mm	25 pc(s).	4317.000	4317.000	4317.000	4317.000	4317.000	1044
	1 cable, max. Ø 47 mm	25 pc(s).	4318.000	4318.000	4318.000	4318.000	4318.000	1044
Connector grommets	10 pc(s).	4311.000	4311.000	4311.000	4311.000	4311.000	4311.000	1044
Section for cable entry, centre	2 pc(s).	8618.801	8618.801	8618.801	8618.801	8618.801	8618.801	1045
Section for cable entry, rear	2 pc(s).	8618.811	8618.811	8618.811	8618.811	8618.811	8618.811	1045
Cable duct		see page	see page	see page	see page	see page	see page	1058
Cable clamp rail, right angle section	2 pc(s).	8619.420	8619.420	8619.420	8619.420	8619.420	8619.420	1059

¹⁾ The VX adaptor rail is required for installation in the vertical enclosure sections. Overview of VX SE compatible rail systems, see page 986

Free-standing enclosure system VX SE

Basic enclosure, width 1000 – 1200 mm

Width (B) mm	Packs of	1000	1200	1200	1200	1200	1200	1200	Page
Height (H) mm		1800	1800	1800	2000	2000	2000	2000	
Depth (T) mm		400	300	400	300	400	500	600	
Mounting plate width (F) mm		899	1099	1099	1099	1099	1099	1099	
Mounting plate height (G) mm		1696	1696	1696	1896	1896	1896	1896	
Model No.	1 pc(s).	5840.600	5824.600	5841.600	5825.600	5843.600	5844.600	5845.600	
Product-specific scope of supply									
Rear panel, one-piece		■	■	■	■	■	■	■	
Door(s)		2	2	2	2	2	2	2	
Accessories									
Base/plinth corner pieces with base/plinth trim panels, front and rear, 100 mm	2 pc(s).	8640.005	8640.007	8640.007	8640.007	8640.007	8640.007	8640.007	881
Base/plinth trim panels, sides, 100 mm	2 pc(s).	8640.031	8640.030	8640.031	8640.030	8640.031	8640.032	8640.033	882
Base/plinth corner pieces with base/plinth trim panels, front and rear, 200 mm	2 pc(s).	8640.024	8640.025	8640.025	8640.025	8640.025	8640.025	8640.025	881
Base/plinth trim panels, sides, 200 mm	2 pc(s).	8640.041	8640.040	8640.041	8640.040	8640.041	8640.042	8640.043	882
Levelling feet	4 pc(s).	4612.000	4612.000	4612.000	4612.000	4612.000	4612.000	4612.000	892
Glazed door		–	–	–	–	–	–	–	
Comfort handle for lock insert	1 pc(s).	8611.020	8611.020	8611.020	8611.020	8611.020	8611.020	8611.020	938
Comfort handle for lock insert and padlock	1 pc(s).	8611.290	8611.290	8611.290	8611.290	8611.290	8611.290	8611.290	938
Comfort handle for profile half-cylinders	1 pc(s).	8611.070	8611.070	8611.070	8611.070	8611.070	8611.070	8611.070	938
Lock inserts		see page	see page	see page	see page	see page	see page	see page	941, 942
180° hinges	4 pc(s).	8800.190	8800.190	8800.190	8800.190	8800.190	8800.190	8800.190	951
Punched section with mounting flange, 14 x 39 mm, for door	4 pc(s).	8619.710	8619.720	8619.720	8619.720	8619.720	8619.720	8619.720	952
Wiring plan pocket, depth 35 mm	1 pc(s).	4115.500	4116.500	4116.500	4116.500	4116.500	4116.500	4116.500	955
Wiring plan pocket, depth 90 mm	1 pc(s).	4115.000	4116.000	4116.000	4116.000	4116.000	4116.000	4116.000	955
Door stay	5 pc(s).	4583.000	4583.000	4583.000	4583.000	4583.000	4583.000	4583.000	956
Door stay for escape routes	1 pc(s).	4583.500	4583.500	4583.500	4583.500	4583.500	4583.500	4583.500	956
Ride-up roller	10 pc(s).	4538.000	4538.000	4538.000	4538.000	4538.000	4538.000	4538.000	956
Adaptor rail VX to fit enclosure height	4 pc(s).	8617.750	8617.750	8617.750	8617.751	8617.751	8617.751	8617.751	995
Punched section with mounting flange 17 x 73 mm for the inner level, in the depth	4 pc(s).	8612.040	8612.030	8612.040	8612.030	8612.040	8612.050	8612.060	992
Punched section with mounting flange 17 x 73 mm for the outer level, in the depth	4 pc(s).	8612.140	8612.130	8612.140	8612.130	8612.140	8612.150	8612.160	992
Punched section with mounting flange 23 x 64 mm for the inner level, in the depth ¹⁾	4 pc(s).	8617.110	8617.100	8617.110	8617.100	8617.110	8617.120	8617.130	991
Punched section with mounting flange 23 x 64 mm for the inner level, in the width ¹⁾	4 pc(s).	8617.150	8617.160	8617.160	8617.160	8617.160	8617.160	8617.160	991
Punched rail 18 x 39 mm for the enclosure depth ¹⁾	4 pc(s).	8617.700	–	8617.700	–	8617.700	8617.710	8617.720	993
Support strip for the outer level for enclosure depth	20 pc(s).	4694.000	–	4694.000	–	4694.000	4695.000	4696.000	994
Support strip for the inner level for enclosure depth	20 pc(s).	4309.000	–	4309.000	–	4309.000	4596.000	8800.130	994
C rail 30/15, for the enclosure width	6 pc(s).	4946.000	4947.000	4947.000	4947.000	4947.000	4947.000	4947.000	996
Support rail 48 x 26 mm, for the enclosure width ¹⁾	2 pc(s).	8617.820	8617.830	8617.830	8617.830	8617.830	8617.830	8617.830	996
LED system light		see page	see page	see page	see page	see page	see page	see page	1014
Earth straps		see page	see page	see page	see page	see page	see page	see page	1033
Cable entry plate	4 pc(s).	8619.802	8619.803	8619.803	8619.803	8619.803	8619.803	8619.803	1044
Cable entry grommets	8 cables, max. Ø 13 mm	25 pc(s).	4316.000	4316.000	4316.000	4316.000	4316.000	4316.000	1044
	3 cables, max. Ø 21 mm	25 pc(s).	4317.000	4317.000	4317.000	4317.000	4317.000	4317.000	1044
	1 cable, max. Ø 47 mm	25 pc(s).	4318.000	4318.000	4318.000	4318.000	4318.000	4318.000	1044
Connector grommets	10 pc(s).	4311.000	4311.000	4311.000	4311.000	4311.000	4311.000	4311.000	1044
Section for cable entry, centre	4 pc(s).	8618.802	8618.803	8618.803	8618.803	8618.803	8618.803	8618.803	1045
Section for cable entry, rear	4 pc(s).	8618.812	8618.813	8618.813	8618.813	8618.813	8618.813	8618.813	1045
Cable duct		see page	see page	see page	see page	see page	see page	see page	1058
Cable clamp rail, right angle section	2 pc(s).	8619.430	8619.440	8619.440	8619.440	8619.440	8619.440	8619.440	1059

¹⁾ The VX adaptor rail is required for installation in the vertical enclosure sections. Overview of VX SE compatible rail systems, see page 986

Free-standing enclosure system VX SE

Basic enclosure, width 1600 – 1800 mm

Width (B) mm	Packs of	1600	1800	Page
Height (H) mm		1800	2000	
Depth (T) mm		400	500	
Mounting plate width (F) mm		1499	1699	
Mounting plate height (G) mm		1696	1896	
Model No.	1 pc(s).	5842.600	5846.600	
Product-specific scope of supply				
Rear panel, two-piece		■	■	
Door(s)		2	2	
Accessories				
Base/plinth corner pieces with base/plinth trim panels, front and rear, 100 mm	2 pc(s).	8640.008	8640.009	881
Base/plinth trim panels, sides, 100 mm	2 pc(s).	8640.031	8640.032	882
Base/plinth corner pieces with base/plinth trim panels, front and rear, 200 mm	2 pc(s).	8640.026	8640.027	881
Base/plinth trim panels, sides, 200 mm	2 pc(s).	8640.041	8640.042	882
Levelling feet	4 pc(s).	4612.000	4612.000	892
Glazed door		–	–	
Comfort handle for lock insert	1 pc(s).	8611.020	8611.020	938
Comfort handle for lock insert and padlock	1 pc(s).	8611.290	8611.290	938
Comfort handle for profile half-cylinders	1 pc(s).	8611.070	8611.070	938
Lock inserts	1 pc(s).	see page	see page	941, 942
180° hinges	4 pc(s).	8800.190	8800.190	951
Punched section with mounting flange, 14 x 39 mm, for door	4 pc(s).	8619.730	8619.740	952
Wiring plan pocket, depth 35 mm	1 pc(s).	4118.500	–	955
Wiring plan pocket, depth 90 mm	1 pc(s).	4118.000	4123.000	955
Door stay	5 pc(s).	4583.000	4583.000	956
Door stay for escape routes	1 pc(s).	4583.500	4583.500	956
Ride-up roller	10 pc(s).	4538.000	4538.000	956
Adaptor rail VX to fit enclosure height	4 pc(s).	8617.750	8617.751	995
Punched section with mounting flange 17 x 73 mm for the inner level, in the depth	4 pc(s).	8612.040	8612.050	992
Punched section with mounting flange 17 x 73 mm for the outer level, in the depth	4 pc(s).	8612.140	8612.150	992
Punched section with mounting flange 23 x 64 mm for the inner level, in the depth ¹⁾	4 pc(s).	8617.110	8617.120	991
Punched section with mounting flange 23 x 64 mm for the inner level, in the width ¹⁾	4 pc(s).	8617.180	8617.190	991
Punched rail 18 x 39 mm for the enclosure depth ¹⁾	4 pc(s).	8617.700	8617.710	993
Support strip for the outer level for enclosure depth	20 pc(s).	4694.000	4695.000	994
Support strip for the inner level for enclosure depth	20 pc(s).	4309.000	4596.000	994
LED system light		see page	see page	1014
Earth straps		see page	see page	1033
Section for cable entry, centre	2 pc(s).	8618.804	–	1045
Section for cable entry, rear	2 pc(s).	8618.814	–	1045
Cable duct		see page	see page	1058
Cable clamp rail, right angle section	2 pc(s).	8619.450	8619.460	1059

¹⁾ The VX adaptor rail is required for installation in the vertical enclosure sections. Overview of VX SE compatible rail systems, see page 986

Free-standing enclosure system VX SE



System accessories Page 877 **VX SE IP 66/NEMA 4X stainless steel** Page 250 **Base/plinth** Page 880

Material and surface finish:

- Enclosure: Sheet steel, 1.5 mm, dipcoat-primed, powder-coated on the outside, textured paint
- Door: Sheet steel, 2 mm, dipcoat-primed, powder-coated on the outside, textured paint
- Rear panel: Sheet steel, 1.5 mm, dipcoat-primed, powder-coated on the outside, textured paint
- Mounting plate: Sheet steel, 3 mm, zinc-plated, passivated
- Base: Sheet steel, 1.5 mm, dipcoat-primed and powder-coated, textured paint

Colour:

- RAL 7035

Protection category IP to IEC 60 529:

- IP 66

Protection category NEMA:

- NEMA 4

Supply includes:

- Enclosure, solid top and sides
- Door(s)
- Door hinged on the right, may be swapped to the left
- Mounting plate
- Base, solid
- Rear panel, detachable
- Lock: 3 mm double-bit
- 2 punched rails 18 x 39 mm

Approvals:

- UL
- cUL

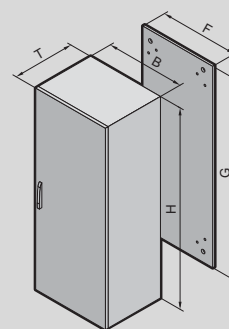

IP 66/NEMA 4

Width (B) mm	Packs of	600	800	800	Page
Height (H) mm		1800	1800	2000	
Depth (T) mm		400	400	600	
Mounting plate width (F) mm		499	699	699	
Mounting plate height (G) mm		1696	1696	1896	
Model No.	1 pc(s).	5830.680	5831.680	5834.680	
Door(s)		1	1	1	

Accessories

Base/plinth corner pieces with base/plinth trim panels, front and rear, 100 mm	2 pc(s).	8640.002	8640.003	8640.003	881
Base/plinth trim panels, sides, 100 mm	2 pc(s).	8640.031	8640.031	8640.033	882
Base/plinth corner pieces with base/plinth trim panels, front and rear, 200 mm	2 pc(s).	8640.022	8640.023	8640.023	881
Base/plinth trim panels, sides, 200 mm	2 pc(s).	8640.041	8640.041	8640.043	882
Levelling feet	4 pc(s).	4612.000	4612.000	4612.000	892
Comfort handle for lock insert	1 pc(s).	8611.020	8611.020	8611.020	938
Comfort handle for lock insert and padlock	1 pc(s).	8611.290	8611.290	8611.290	938
Comfort handle for profile half-cylinders	1 pc(s).	8611.070	8611.070	8611.070	938
Lock inserts		see page	see page	see page	941, 942
Punched section with mounting flange, 14 x 39 mm, for door	4 pc(s).	8619.720	8619.730	8619.730	952
Wiring plan pocket, depth 90 mm	1 pc(s).	4116.000	4118.000	4118.000	955
Door stay	5 pc(s).	4583.000	4583.000	4583.000	956
Adaptor rail VX to fit enclosure height	4 pc(s).	8617.750	8617.750	8617.751	995
Punched section with mounting flange 17 x 73 mm for the inner level, in the depth	4 pc(s).	8612.040	8612.040	8612.060	992
Punched section with mounting flange 17 x 73 mm for the outer level, in the depth	4 pc(s).	8612.140	8612.140	8612.160	992
Punched section with mounting flange 23 x 64 mm for the inner level, in the depth ¹⁾	4 pc(s).	8617.110	8617.110	8617.130	991
Punched section with mounting flange 23 x 64 mm for the inner level, in the width ¹⁾	4 pc(s).	8617.130	8617.140	8617.140	991
LED system light		see page	see page	see page	1014
Earth straps		see page	see page	see page	1033
Cable clamp rail, right angle section	2 pc(s).	8619.410	8619.420	8619.420	1059

¹⁾ The VX adaptor rail is required for installation in the vertical enclosure sections. Overview of VX SE compatible rail systems, see page 986

Rittal – The System.

Faster – better – everywhere.



Console systems/ PC enclosure systems/ Industrial Workstations

Product comparison	150
TopConsole system TP	
Overview of installation components	153
Combination options	156
600 mm wide	157
800 mm wide	158
1200 mm wide	159
1600 mm wide	160
One-piece consoles TP	
One-piece consoles TP	161
Universal consoles TP	
Universal consoles TP	162
PC enclosure systems	
PC enclosure systems	164
Industrial Workstations	
Combination options	166
IW enclosures and worktops	167



Console systems/PC enclosure systems/IW – Product comparison



	TopConsole system	One-piece consoles	
Version	Modular console system for operation and monitoring. The separate modules have independent lock systems.	One-piece console for operation and monitoring, with large mounting plate	
Protection category IP to IEC 60 529	IP 55	IP 55	
Protection category NEMA	NEMA 12	NEMA 12	
Service access	Console from the front, desk unit from above, pedestal from the front (for a depth of 500 mm from the front and rear)	From the front and above	
Lock system	Lock inserts may be replaced individually	Lock inserts may be replaced individually	
Installation options	Option for interior installation with bar systems on a 25 mm pitch pattern in all modules plus additional installation with partial mounting plates	Option for interior installation with bar systems on a 25 mm pitch patterns plus additional installation with partial mounting plates	
from page	153	161	

Console systems/PC enclosure systems/IW – Product comparison



	Universal consoles	PC enclosure systems	Industrial Workstations
	Enclosures with a high level of stability. The standard rear door provides free access to the continuous mounting plate. The mounting plate has a C-fold and is depth-adjustable on a 25 mm pitch pattern. The front may optionally be equipped with a short door and desk section or tall door.	Enclosure body folded from a single piece for a high level of stability. Continuous rear door for simple service access from the rear. High level of access protection thanks to an interior lock on the glazed door and lockable keyboard drawer. There are four versions with different operating concepts available to suit individual requirements.	Modular enclosure system for operation and monitoring. Five different enclosure variants may be combined into individual workstations with special worktops and command panels.
	IP 55	IP 55	IP 54/55
	NEMA 12	NEMA 12	NEMA 12
	From the front and rear	From the front and above	From the front and above
	Lock inserts may be replaced individually	Lock inserts may be replaced individually	Lock inserts may be replaced individually
	Option for interior installation with bar systems on a 25 mm pitch pattern. The desk unit may be designed as an operator console.	Option for interior installation with bar systems on a 25 mm pitch pattern. For the lower area, component shelves are available to accommodate computers, printers etc. plus a paper removal flap allowing the printer to be used without opening the door.	For the lower area, component shelves are available to accommodate computers, printers etc. plus a paper removal flap allowing the printer to be used without opening the door. The worktop may be extended with components from support arm system CP 60 and a command panel to create a complete workstation.
	162	164	166

Rittal – The System.

Faster – better – everywhere.



TopConsole system TP

Overview of installation components

- 1 Three-part assembly comprising:
 - Console
 - Desk unit
 - Pedestal
- 2 Two-part assembly comprising:
 - Desk unit
 - Pedestal
- 3 One-part assembly comprising:
 - Cover plate
 - Pedestal



TopConsole system TP



Fast planning and assembly

- Identical covers for the console and desk unit ensure straightforward engineering
- Individual installation with bar systems
- Simple installation of preassembled modules using partial mounting plates



Simple handling

- Simple one-handed operation and reliable latching of the lid stay in the topmost position
- Secure lock mechanism with end stop acknowledgement, suitable for all common lock inserts
- Stylishly finished with an aluminium strip (accessory) as a design or handle element on the cover



Flexible interior installation

- Rapid assembly of the mounting plate, simply insert and clip into place (400 mm construction depth)
- Depth-adjustable mounting plate (500 mm construction depth)
- Plenty of free space for individual configuration on the mounting plate
- Individual installation with bar systems
- Two-piece gland plates for simple cable entry



TopConsole system TP



System accessories Page 877 **Monitors, keyboards** Page 1109/1110 **Climate control** Page 449

Material:

- Enclosure: Sheet steel, 1.5 mm
- Door and console cover: Sheet steel, 2.0 mm, all-round foamed-in PU seal
- Mounting plate: Sheet steel 2.5 mm (depth 500 mm), 3.0 mm (depth 400 mm)

Surface finish:

- Enclosure, cover and door: Dipcoat-primed, powder-coated on the outside, textured paint
- Mounting plate: Zinc-plated

Colour:

- RAL 7035

Protection category IP to IEC 60 529:

- IP 55

Protection category NEMA:

- NEMA 12

Supply includes:

- Console**
- Enclosure
- Cover hinged at bottom, including cover retainer
- Open base for individual cable entry

Desk section

- Enclosure
- Hinged cover, 2 stays with automatic latching, automatic unlatching on the left and manual unlatching on the right
- Opening for cable entry into the enclosure base

Pedestal

- Enclosure open at top
- Door or double door with locking rod (with depth 400 mm at the front, with depth 500 mm at the front and rear)
- Depth-adjustable mounting plate (with depth 500 mm)
- Gland plates

Approvals:

- UL
- cUL

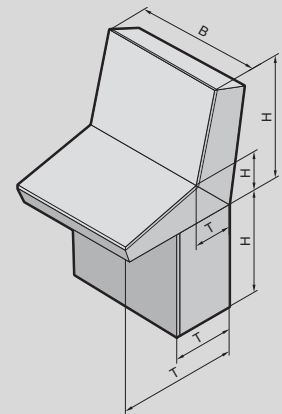
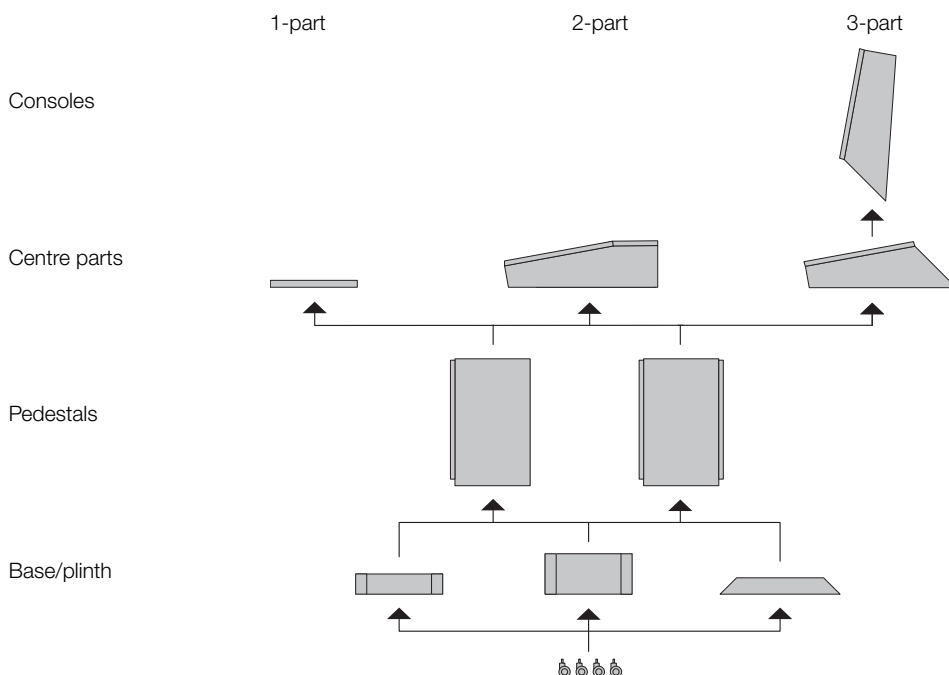

Photo shows a configuration example with equipment not included in the scope of supply

Combination options



TopConsole system TP

600 mm wide

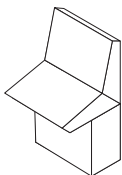
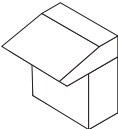
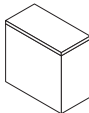
								
	Configuration	3-part		2-part		1-part		
	Depth of pedestal in mm	400	500	400	500	400	500	

Consoles

	Height (H) mm	Packs of	720	-	-	Page
	Depth (T) mm		240	-	-	
	Model No.	1 pc(s).	6720.500	-	-	

Accessories

Partial mounting plate, locatable	Width 200 mm	1 pc(s).	6730.310	-	-	982
	Width 500 mm	1 pc(s).	6730.330	-	-	982
Rail for interior installation	For width	4 pc(s).	5001.050	-	-	995

Centre parts

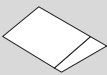
	Height (H) mm	Packs of	235	235	-	Page
	Depth (T) mm		730	755	-	
	Model No.	1 pc(s).	6714.500	6710.500	-	

Accessories

Rail for interior installation	For width	4 pc(s).	5001.050	5001.050	-	995
--------------------------------	-----------	----------	----------	----------	---	-----

Cover plate

	Height (H) mm	Packs of	-	-	27		Page
	Depth (T) mm		-	-	400	500	
	Model No.	1 pc(s).	-	-	5001.130	6730.100	163

Pedestals

	Height (H) mm	Packs of	675	675	675	675	675	675	Page
	Depth (T) mm		400	500	400	500	400	500	
	Model No.	1 pc(s).	6700.600	6704.600	6700.600	6704.600	6700.600	6704.600	

Accessories

Base/plinth corner pieces with base/plinth trim panels, front and rear	Height 100 mm	2 pc(s).	8640.002	8640.002	8640.002	8640.002	8640.002	8640.002	881
	Height 200 mm	2 pc(s).	8640.022	8640.022	8640.022	8640.022	8640.022	8640.022	881
Base/plinth trim panels, sides	Height 100 mm	2 pc(s).	8640.031	8640.032	8640.031	8640.032	8640.031	8640.032	882
	Height 200 mm	2 pc(s).	8640.041	8640.042	8640.041	8640.042	8640.041	8640.042	882
Cross member		2 pc(s).	8601.450	8601.450	8601.450	8601.450	8601.450	8601.450	891
Rail for interior installation	For height	4 pc(s).	5001.050	5001.050	5001.050	5001.050	5001.050	5001.050	995
Punched section with mounting flange, 17 x 73 mm	In the depth	4 pc(s).	8612.140	8612.150	8612.140	8612.150	8612.140	8612.150	992
Support strip	In the depth	20 pc(s).	4694.000	4695.000	4694.000	4695.000	4694.000	4695.000	994
Punched section with mounting flange, 17 x 73 mm	For door	4 pc(s).	8612.050	8612.050	8612.050	8612.050	8612.050	8612.050	992
Support strip	For door	20 pc(s).	4596.000	4596.000	4596.000	4596.000	4596.000	4596.000	952
Cable clamp rail		1 pc(s).	5001.080	5001.080	5001.080	5001.080	5001.080	5001.080	1059
Sheet steel wiring plan pockets		1 pc(s).	4116.500	4116.500	4116.500	4116.500	4116.500	4116.500	955
TP aluminium strip		1 pc(s).	6731.120	6731.120	6731.120	6731.120	-	-	163
Lock systems			from page	from page	from page	from page	from page	from page	935
LED system light			see page	see page	see page	see page	see page	see page	1014

TopConsole system TP

800 mm wide

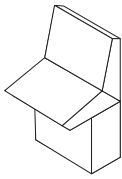
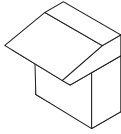
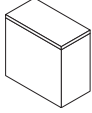
								
	Configuration	3-part		2-part		1-part		
	Depth of pedestal in mm	400	500	400	500	400	500	

Consoles							
	Height (H) mm	Packs of	720	-	-	-	Page
	Depth (T) mm		240	-	-	-	
	Model No.	1 pc(s).	6721.500	-	-	-	

Accessories							
Partial mounting plate, locatable	Width 200 mm	1 pc(s).	6730.310	-	-	-	982
	Width 500 mm	1 pc(s).	6730.330	-	-	-	982
	Width 700 mm	1 pc(s).	6730.340	-	-	-	982
Rail for interior installation	For width	4 pc(s).	5001.051	-	-	-	995

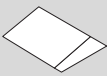
Centre parts							
	Height (H) mm	Packs of	235	235	-	-	Page
	Depth (T) mm		730	755	-	-	
	Model No.	1 pc(s).	6715.500	6711.500	-	-	

Accessories							
Rail for interior installation	For width	4 pc(s).	5001.051	5001.051	-	-	995

Cover plate							
	Height (H) mm	Packs of	-	-	27		Page
	Depth (T) mm		-	-	400	500	
	Model No.	1 pc(s).	-	-	5001.140	6730.110	163

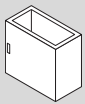
Pedestals									
	Height (H) mm	Packs of	675	675	675	675	675	675	Page
	Depth (T) mm		400	500	400	500	400	500	
	Model No.	1 pc(s).	6701.600	6705.600	6701.600	6705.600	6701.600	6705.600	

Accessories									
Base/plinth corner pieces with base/plinth trim panels, front and rear	Height 100 mm	2 pc(s).	8640.003	8640.003	8640.003	8640.003	8640.003	8640.003	881
	Height 200 mm	2 pc(s).	8640.023	8640.023	8640.023	8640.023	8640.023	8640.023	881
Base/plinth trim panels, sides	Height 100 mm	2 pc(s).	8640.031	8640.032	8640.031	8640.032	8640.031	8640.032	882
	Height 200 mm	2 pc(s).	8640.041	8640.042	8640.041	8640.042	8640.041	8640.042	882
Cross member		2 pc(s).	8601.450	8601.450	8601.450	8601.450	8601.450	8601.450	891
Rail for interior installation	For height	4 pc(s).	5001.050	5001.050	5001.050	5001.050	5001.050	5001.050	995
Punched section with mounting flange, 17 x 73 mm	In the depth	4 pc(s).	8612.140	8612.150	8612.140	8612.150	8612.140	8612.150	992
Support strip	In the depth	20 pc(s).	4694.000	4695.000	4694.000	4695.000	4694.000	4695.000	994
Support strip	For door	20 pc(s).	4598.000	4598.000	4598.000	4598.000	4598.000	4598.000	952
Cable clamp rail		1 pc(s).	5001.081	5001.081	5001.081	5001.081	5001.081	5001.081	1059
Sheet steel wiring plan pockets		1 pc(s).	4118.500	4118.500	4118.500	4118.500	4118.500	4118.500	955
TP aluminium strip		1 pc(s).	6731.120	6731.120	6731.120	6731.120	-	-	163
Lock systems			from page	from page	from page	from page	from page	from page	935
LED system light			see page	see page	see page	see page	see page	see page	1014

TopConsole system TP

1200 mm wide

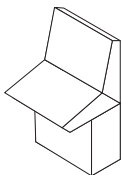
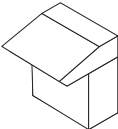
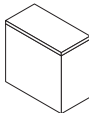
								
	Configuration	3-part		2-part		1-part		
	Depth of pedestal in mm	400	500	400	500	400	500	

Consoles

	Height (H) mm	Packs of	720	-	-	Page
	Depth (T) mm		240	-	-	
	Model No.	1 pc(s).	6722.500	-	-	

Accessories

Partial mounting plate, locatable	Width 200 mm	1 pc(s).	6730.310	-	-	982
	Width 500 mm	1 pc(s).	6730.330	-	-	982
	Width 700 mm	1 pc(s).	6730.340	-	-	982
Rail for interior installation	For width	4 pc(s).	5001.053	-	-	995

Centre parts

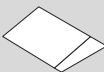
	Height (H) mm	Packs of	235	235	-	Page
	Depth (T) mm		730	755	-	
	Model No.	1 pc(s).	6716.500	6712.500	-	

Accessories

Rail for interior installation	For width	4 pc(s).	5001.053	5001.053	-	995
--------------------------------	-----------	----------	----------	----------	---	-----

Cover plate

	Height (H) mm	Packs of	-	-	27		Page
	Depth (T) mm		-	-	400	500	
	Model No.	1 pc(s).	-	-	5001.160	6730.120	163

Pedestals

	Height (H) mm	Packs of	675	675	675	675	675	675	Page
	Depth (T) mm		400	500	400	500	400	500	
	Model No.	1 pc(s).	6702.600	6706.600	6702.600	6706.600	6702.600	6706.600	

Accessories

Base/plinth corner pieces with base/plinth trim panels, front and rear	Height 100 mm	2 pc(s).	8640.007	8640.007	8640.007	8640.007	8640.007	8640.007	881
	Height 200 mm	2 pc(s).	8640.025	8640.025	8640.025	8640.025	8640.025	8640.025	881
Base/plinth trim panels, sides	Height 100 mm	2 pc(s).	8640.031	8640.032	8640.031	8640.032	8640.031	8640.032	882
	Height 200 mm	2 pc(s).	8640.041	8640.042	8640.041	8640.042	8640.041	8640.042	882
Cross member		2 pc(s).	8601.450	8601.450	8601.450	8601.450	8601.450	8601.450	891
Rail for interior installation	For height	4 pc(s).	5001.050	5001.050	5001.050	5001.050	5001.050	5001.050	995
Punched section with mounting flange, 17 x 73 mm	In the depth	4 pc(s).	8612.140	8612.150	8612.140	8612.150	8612.140	8612.150	992
Support strip	In the depth	20 pc(s).	4694.000	4695.000	4694.000	4695.000	4694.000	4695.000	994
Punched section with mounting flange, 17 x 73 mm	For door	4 pc(s).	8612.050	8612.050	8612.050	8612.050	8612.050	8612.050	992
Support strip	For door	20 pc(s).	4596.000	4596.000	4596.000	4596.000	4596.000	4596.000	952
Cable clamp rail		1 pc(s).	5001.083	5001.083	5001.083	5001.083	5001.083	5001.083	1059
Sheet steel wiring plan pockets		1 pc(s).	4116.500	4116.500	4116.500	4116.500	4116.500	4116.500	955
TP aluminium strip		1 pc(s).	6731.120	6731.120	6731.120	6731.120	-	-	163
Lock systems			from page	from page	from page	from page	from page	from page	935
LED system light			see page	see page	see page	see page	see page	see page	1014

TopConsole system TP

1600 mm wide

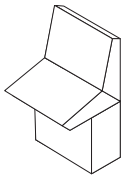
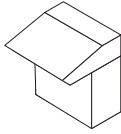
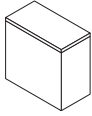
								
	Configuration	3-part		2-part		1-part		
	Depth of pedestal in mm	400	500	400	500	400	500	

Consoles							
	Height (H) mm	Packs of	720	-	-	-	Page
	Depth (T) mm		240	-	-	-	
	Model No.	1 pc(s).	6723.500	-	-	-	

Accessories							
Partial mounting plate, locatable	Width 200 mm	1 pc(s).	6730.310	-	-	-	982
	Width 500 mm	1 pc(s).	6730.330	-	-	-	982
	Width 700 mm	1 pc(s).	6730.340	-	-	-	982
Rail for interior installation	For width	4 pc(s).	5001.054	-	-	-	995

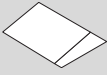
Centre parts							
	Height (H) mm	Packs of	235	235	-	-	Page
	Depth (T) mm		730	755	-	-	
	Model No.	1 pc(s).	6717.500	6713.500	-	-	

Accessories							
Rail for interior installation	For width	4 pc(s).	5001.054	5001.054	-	-	995

Trim panel							
	Height (H) mm	Packs of	-	-	27		Page
	Depth (T) mm		-	-	400	500	
	Model No.	1 pc(s).	-	-	6730.030	6730.130	163

Pedestals									
	Height (H) mm	Packs of	675	675	675	675	675	675	Page
	Depth (T) mm		400	500	400	500	400	500	
	Model No.	1 pc(s).	6703.600	6707.600	6703.600	6707.600	6703.600	6707.600	

Accessories									
Base/plinth corner pieces with base/plinth trim panels, front and rear	Height 100 mm	2 pc(s).	8640.008	8640.008	8640.008	8640.008	8640.008	8640.008	881
	Height 200 mm	2 pc(s).	8640.026	8640.026	8640.026	8640.026	8640.026	8640.026	881
Base/plinth trim panels, sides	Height 100 mm	2 pc(s).	8640.031	8640.032	8640.031	8640.032	8640.031	8640.032	882
	Height 200 mm	2 pc(s).	8640.041	8640.042	8640.041	8640.042	8640.041	8640.042	882
Cross member		2 pc(s).	8601.450	8601.450	8601.450	8601.450	8601.450	8601.450	891
Rail for interior installation	For height	4 pc(s).	5001.050	5001.050	5001.050	5001.050	5001.050	5001.050	995
Punched section with mounting flange, 17 x 73 mm	In the depth	4 pc(s).	8612.140	8612.150	8612.140	8612.150	8612.140	8612.150	992
Support strip	In the depth	20 pc(s).	4694.000	4695.000	4694.000	4695.000	4694.000	4695.000	994
Support strip	For door	20 pc(s).	4598.000	4598.000	4598.000	4598.000	4598.000	4598.000	952
Cable clamp rail	Width 800 mm	1 pc(s).	5001.081	5001.081	5001.081	5001.081	5001.081	5001.081	1059
Sheet steel wiring plan pockets		1 pc(s).	4118.500	4118.500	4118.500	4118.500	4118.500	4118.500	955
TP aluminium strip		1 pc(s).	6731.120	6731.120	6731.120	6731.120	-	-	163
Lock systems			from page	from page	from page	from page	from page	from page	935
LED system light			see page	see page	see page	see page	see page	see page	1014



System accessories P. 877 **Monitors, keyboards** P. 1109/1110 **Climate control** P. 449 **One-piece consoles, stainless steel** P. 251

Material:

- Enclosure: Sheet steel, 1.5 mm
- Door and console cover: Sheet steel, 2.0 mm, all-round foamed-in PU seal
- Mounting plate: Sheet steel, 3.0 mm

Surface finish:

- Enclosure, cover and door: Dipcoat-primed, powder-coated on the outside, textured paint
- Mounting plate: Zinc-plated

Colour:

- RAL 7035

Protection category IP to IEC 60 529:

- IP 55

Protection category NEMA:

- NEMA 12

Supply includes:

- Enclosure, solid back and sides
- Door or double door at front, with locking rod
- Mounting plate
- Cover hinged at rear, 2 stays with automatic locking. Automatic unlocking on the left, manual unlocking on the right
- Gland plates

Approvals:

- UL
- cUL

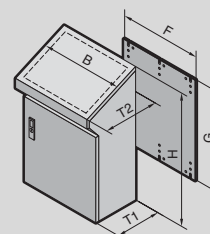

	Packs of	600	800	1000	1200	Page
Width (B) mm		600	800	1000	1200	
Height (H) mm		975	975	975	975	
Depth, bottom (T1) mm		400	400	400	400	
Depth, top (T2) mm		520	520	520	520	
Mounting plate width (F) mm		530	730	930	1130	
Mounting plate height (G) mm		900	900	900	900	
Model No.	1 pc(s).	6746.600	6748.600	6740.600	6742.600	
Door(s)		1	1	2	2	

Accessories

Base/plinth corner pieces with base/plinth trim panels, front and rear, 100 mm	2 pc(s).	8640.002	8640.003	8640.005	8640.007	881
Base/plinth trim panels, sides, 100 mm	2 pc(s).	8640.031	8640.031	8640.031	8640.031	882
Base/plinth corner pieces with base/plinth trim panels, front and rear, 200 mm	2 pc(s).	8640.022	8640.023	8640.024	8640.025	881
Base/plinth trim panels, sides, 200 mm	2 pc(s).	8640.041	8640.041	8640.041	8640.041	882
Cross member	2 pc(s).	8601.450	8601.450	8601.450	8601.450	891
TP aluminium strip	1 pc(s).	6731.120	6731.120	6731.120	6731.120	163
Rail for interior installation		see page	see page	see page	see page	995
Punched section with mounting flange, 17 x 73 mm		see page	see page	see page	see page	992
Cable clamp rails	1 pc(s).	5001.080	5001.081	5001.082	5001.083	1059
Sheet steel wiring plan pockets	1 pc(s).	4116.500	4118.500	4115.500	4116.500	955
LED system light		see page	see page	see page	see page	1014

Universal consoles TP



System accessories Page 877 **Monitors, keyboards** Page 1109/1110 **Climate control** Page 449

Material:

- Enclosure, gland plate: Sheet steel, 1.5 mm
- Door: Sheet steel, 2.0 mm
- Mounting plate: Sheet steel, 3.0 mm

Surface finish:

- Enclosure and door: Dipcoat-primed, powder-coated on the outside, textured paint
- Mounting plate and gland plates: Zinc-plated

Colour:

- RAL 7035

Protection category IP to IEC 60 529:

- IP 55

Protection category NEMA:

- NEMA 12

Supply includes:

- Enclosure with door(s)
- Mounting plate
- Gland plates



Note:

- For universal console with short front door: The desk section should be fitted in order to maintain the protection category

Approvals:

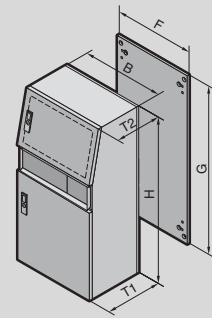
- UL
- CSA
- TÜV
- Russian Maritime Register of Shipping

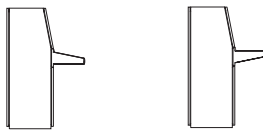

				
Version	Packs of	With short front door	With tall front door	Page
Width (B) mm		600	600	
Height (H) mm		1300	1300	
Depth, bottom (T1) mm		500	500	
Depth, top (T2) mm		417.5	417.5	
Mounting plate width (F) mm		499	499	
Mounting plate height (G) mm		1196	1196	
Model No.	1 pc(s).	2694.500	2695.500	
Weight kg		77.0	80.0	
Also required				
Desk section	1 pc(s).	2696.500	-	163
Accessories				
Base/plinth, complete	1 pc(s).	2807.200	2807.200	890
Cross member	2 pc(s).	8601.450	8601.450	891
Cable clamp rail	2 pc(s).	5001.080	5001.080	1059
Lock systems		from page	from page	935

TopConsole system TP

Accessories

TP aluminium strip

For retrospective external mounting on TP desk units, consoles and one-piece consoles.

Applications:

- TP three-part/two-part
- One-piece consoles TP
- May be mounted on all enclosures/covers with 20 mm fold height (max. metal thickness 2 mm)

Installation options:

- Easily cut to length for other sizes
- 3 x width 600 mm
- 2 x width 800 mm
- 1 x width 1000 mm + 1 x width 600 mm
- 1 x width 1200 mm
- 1 x width 1600 mm

Material:

- Extruded aluminium section
- Cover caps: Plastic

Surface finish:

- Aluminium extruded section: Natural anodised

Colour:

- Cover caps: RAL 7035

Length mm	Model No.
1750	6731.120

Supply includes:

- 1 aluminium section
- 6 plastic cover caps
- Drilling template
- Assembly parts



Cover plate

for TP

As cover for a TP pedestal.

Material:

- Sheet steel

Surface finish:

- Textured paint

Colour:

- RAL 7035

Protection category IP to IEC 60 529:

- IP 55

Protection category NEMA:

- NEMA 12

Supply includes:

- Assembly parts

For enclosure		Model No.
Width mm	Depth mm	
600	400	5001.130
800	400	5001.140
1200	400	5001.160
1600	400	6730.030
600	500	6730.100
800	500	6730.110
1200	500	6730.120
1600	500	6730.130



Desk section

for TP universal console

For installing display and control components and a keyboard. Closed at the side and front. Cover plates for top and bottom.

Material:

- Sheet steel

Surface finish:

- Dipcoat-primed, powder-coated on the outside, textured paint

Colour:

- RAL 7035

Protection category IP to IEC 60 529:

- IP 55

Protection category NEMA:

- NEMA 12

Supply includes:

- Assembly parts

Height mm	Model No.
200	2696.500

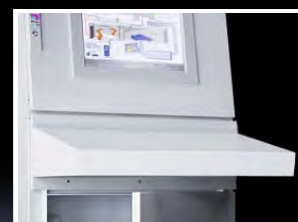

PC enclosure systems



Lock systems Page 934 Climate control Page 449 PC enclosure system, stainless steel Page 252 System accessories Page 877

Secure accommodation of all PC components, from monitors, to PCs, to keyboards. For ultimate ease of operation in a modern design. Perfect protection from humidity and dirt, temperature fluctuations and unauthorised access.

Material:

- Enclosure, door, rear door, mounting compartment, supports: Sheet steel
- Handles, decorative trim panels: Plastic
- Door trim panel: Aluminium
- Viewing window: Single-pane safety glass

Surface finish:

- Enclosure and door: Dipcoat-primed, powder-coated on the outside, textured paint
- Mounting compartment, support: Powder-coated

Colour:

- Enclosure, door, decorative trim panels, supports: RAL 7035
- Handle: RAL 7015
- Monitor panel, door centre part: RAL 7015

Protection category IP to IEC 60 529:

- IP 55

Protection category NEMA:

- NEMA 12

Supply includes:

- Enclosure, door, rear door
- Please note the product-specific scope of supply.

Approvals:

- UL
- cUL

Width 600 mm

Width mm	Packs of	600	600	600	600	Page
Height mm		1600	1600	1600	1600	
Depth mm		636	636	636	636	
Product-specific scope of supply						
Glazed door, top		■	■	■	■	
Keyboard drawer		■	-	-	■	
Component shelf		■	■	■	■	
Fold-out keyboard tray		-	■	-	-	
Desk section		-	-	■	-	
Mounting compartment, small		-	-	-	■	
Model No.	1 pc(s).	5366.050	5366.150	5366.250	5366.350	
Max. keyboard dimensions (W x H x D) mm		480 x 70 x 260	497 x 50 x 250 497 x 60 x 200	540 x 40 x 175	480 x 70 x 260	
Weight kg		101.4	98.0	95.5	95.5	
Accessories						
Base/plinth, stationary	1 pc(s).	8800.920	8800.920	8800.920	8800.920	890
Base/plinth corner pieces with base/plinth trim panels, front and rear, 100 mm	2 pc(s).	8640.002	8640.002	8640.002	8640.002	881
Base/plinth trim panels, sides, 100 mm	2 pc(s).	8640.033	8640.033	8640.033	8640.033	882
Base/plinth corner pieces with base/plinth trim panels, front and rear, 200 mm	2 pc(s).	8640.022	8640.022	8640.022	8640.022	881
Base/plinth trim panels, sides, 200 mm	2 pc(s).	8640.043	8640.043	8640.043	8640.043	881
Partial mounting plates ¹⁾	1 pc(s).	8617.550	8617.550	8617.550	8617.550	975
Component shelf, pull-out	1 pc(s).	6902.960	6902.960	6902.960	6902.960	1007
Drawer tray	1 pc(s).	6902.700	6902.700	6902.700	6902.700	1007
Paper removal flap	1 pc(s).	6903.200	6903.200	6903.200	6903.200	1116

¹⁾ The adaptor rail for VX compatibility is required for the installation, see page 995

PC enclosure systems

Width 600 – 800 mm

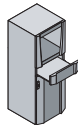
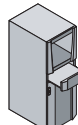
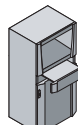
					
Width mm	Packs of	600	600	800	Page
Height mm		1600	1600	1600	
Depth mm		636	836	636	
Product-specific scope of supply					
Keyboard drawer		■	■	■	
Mounting compartment, large		■	–	–	
Glazed door, top		–	■	■	
Component shelf		–	■	■	
Model No.	1 pc(s).	5366.450	5368.050	5386.050	
Max. keyboard dimensions (W x H x D) mm		480 x 70 x 260	480 x 70 x 260	480 x 70 x 260	
Weight kg		97.5	111.0	117.6	
Accessories					
Base/plinth, stationary	1 pc(s).	8800.920	–	–	890
Base/plinth corner pieces with base/plinth trim panels, front and rear, 100 mm	2 pc(s).	8640.002	8640.002	8640.003	881
Base/plinth trim panels, sides, 100 mm	2 pc(s).	8640.033	8640.034	8640.033	881
Base/plinth corner pieces with base/plinth trim panels, front and rear, 200 mm	2 pc(s).	8640.022	8640.022	8640.023	881
Base/plinth trim panels, sides, 200 mm	2 pc(s).	8640.043	8640.044	8640.043	881
Partial mounting plates ¹⁾	1 pc(s).	8617.550	8617.550	8617.580	975
Component shelf, pull-out	1 pc(s).	6902.960	6902.980	–	1007
Drawer tray	1 pc(s).	6902.700	6902.700	–	1007
Paper removal flap	1 pc(s).	6903.200	6903.200	6903.200	1116

¹⁾ The adaptor rail for VX compatibility is required for the installation, see page 995

Industrial Workstations



System accessories Page 877 **Comfort Panel** Page 172 **Optipanel** Page 174 **TFT monitor** Page 1109

Material:

- Enclosure, roof, drawer tray, designer door, rear wall and rear door: Sheet steel
- Worktop: Chipboard, plastic-laminated on both sides (edging)
- Handle: Aluminium, powder-coated

Surface finish:

- Enclosure: Dipcoat-primed, powder-coated on the outside, textured paint

Farbe:

- Enclosure, worktop: RAL 7035
- Worktop edge strip: RAL 7015
- Worktop handle: RAL 9006

Protection category:

- See table

Supply includes:

Available on the Internet

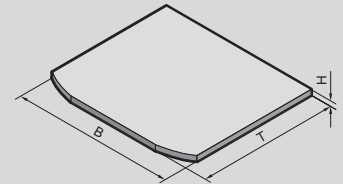
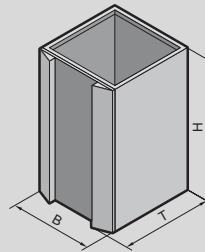
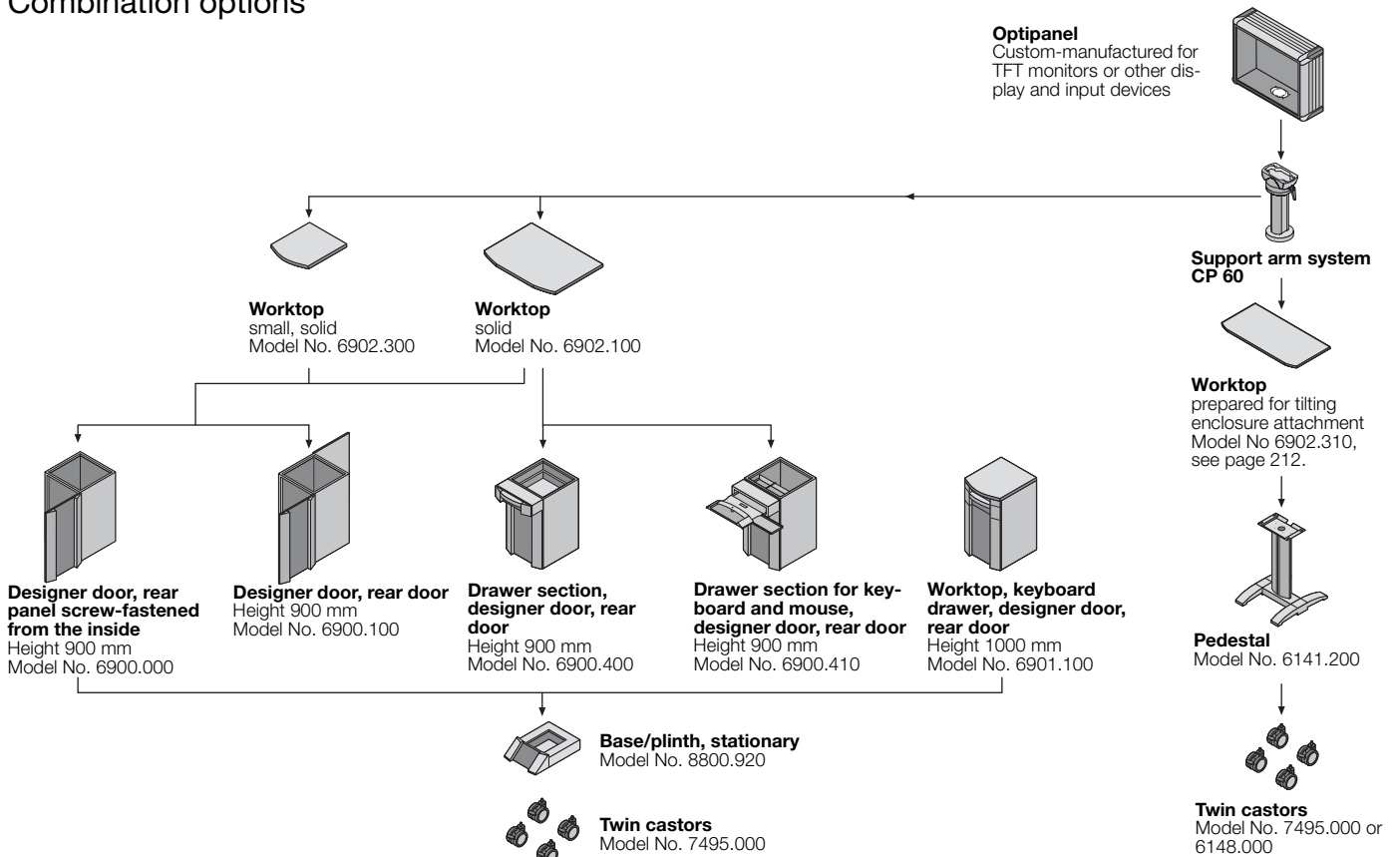





Photo shows a configuration example with equipment not included in the scope of supply

Combination options



IW enclosures and worktops

Enclosure										Page	
Version					Designer door, rear panel screw-fastened from the inside	Designer door, rear door	Drawer section, designer door, rear door	Drawer section for keyboard and mouse, designer door, rear door	Worktop, keyboard drawer, designer door, rear door		
Width (B) mm					600	600	600	600	600		
Height (H) mm					900	900	900	900	1000		
Depth (T) mm					600	600	600 (890)	600 (890)	645		
Weight (kg)					54.9	59.9	73	73	91		
Model No.					6900.000	6900.100	6900.400	6900.410	6901.100		
Protection category IP to IEC 60 529					IP 55		IP 54				
Protection category NEMA					NEMA 12		NEMA 12				
	Width (B) mm	Height (H) mm	Depth (T) mm	Weight kg	Model No.						
Worktops											
	610	38	645	11.6	6902.300	6902.300	–	–	■		
	1000	38	895	24	6902.100	6902.100	6902.100	6902.100	–		
Accessories					Packs of						
Base/plinth, stationary					1 pc(s).	8800.920	8800.920	8800.920	8800.920	8800.920	890
Cross member, adjustable					2 pc(s).	8601.680	8601.680	8601.680	8601.680	–	891
Twin castors					4 pc(s).	7495.000	7495.000	7495.000	7495.000	7495.000	893
Handle adaptor for comfort handle					1 pc(s).	8611.300	8611.300	–	–	–	918
Cable gland					1 pc(s).	6902.770	6902.770	6902.770	6902.770	6902.770	1046
Partial mounting plate VX for enclosure width 600 mm ¹⁾					1 pc(s).	see page	see page	see page	see page	see page	975
Component shelf, static installation					1 pc(s).	8800.900	8800.900	8800.900	8800.900	8800.900	1007
Component shelf, pull-out					1 pc(s).	6902.960	6902.960	6902.960	6902.960	6902.960	1007
Drawer tray					1 pc(s).	6902.700	6902.700	6902.700	6902.700	6902.700	1007
Paper removal flap					1 pc(s).	6903.200	6903.200	6903.200	6903.200	6903.200	1116
Support arm systems						see page	see page	see page	see page	see page	183
Operating housings						see page	see page	see page	see page	see page	169

¹⁾ The adaptor rail for VX compatibility is required for the installation, see page 995

Rittal – The System.

Faster – better – everywhere.



Operating housings/ support arm systems/ stand systems

Comfort Panel

Product comparison	170
Comfort Panel	172
Comfort Panel, configuration examples	173

Optipanel

Product comparison	170
Optipanel	174
Optipanel, configuration examples	175



Operating housings AX

Product comparison	170
Product advantages	176
Operating housings AX with handle strips	178
Operating housing AX for desktop TFT up to 24"	180

Compact Panel

Product comparison	170
Compact Panel	181

Support arm systems

Support arm systems, overview	183
Support arm system CP 40, steel	185
Support arm system CP 40, stainless steel	188
Support arm system CP 60	193
Support arm system CP 120	197
Support arm system CP 180	201
Support section, height-adjustable	205
Accessories	207

Stand systems

Pedestal, modular	211
Pedestal, complete	212
Pedestal, open/pillar, small	213
Accessories	214



Operating housings – Product comparison



		Comfort Panel	Optipanel	
Design		Enclosure made from extruded aluminium section with cooling fins for optimum passive cooling	Enclosure made from extruded aluminium section	
Protection category IP to IEC 60 529		IP 65	IP 65	
Protection category NEMA		NEMA 12	NEMA 12	
No. of sizes		7 standard sizes available off the shelf	7 standard sizes available off the shelf	
Support arm connection	Cross-section	□ 120 x 65 mm up to depth 74 mm, Ø 130 mm from depth 152 mm	□ 120 x 65 mm depth 100 mm, Ø 130 mm depth 150 mm	
	Quantity/ position	1/top Bottom by rotating the enclosure	1/top Bottom by rotating the enclosure	
Servicing access		From the rear, depending on the enclosure, hinged or screw-fastened; with the screw-fastened rear panel, the front flips open	From the rear, hinged rear panel	
Lock system		Lock inserts may be replaced individually	Lock inserts may be replaced individually	
Equipment		Prepared for the direct mounting of standard machine controllers and industrial PCs with corresponding screw clamps; all-round mounting channels integrated into the section for individual mounting of accessory components	Prepared for the direct mounting of standard machine controllers and industrial PCs with corresponding screw clamps	
from page		172	174	

Operating housings – Product comparison



	Operating housings AX with handle strips	Operating housing AX for desktop TFT	Compact Panel
	Enclosure made from sheet steel and front panel made from aluminium	Sheet steel enclosure and viewing panel made from 3 mm single-pane safety glass	Roof and base tray made from die-cast zinc, powder-coated, side panels made from extruded aluminium section, powder-coated
	IP 55	IP 65	IP 65
	NEMA 12	NEMA 12	NEMA 12
	10 standard sizes available off the shelf	1 standard size available off the shelf	4 standard sizes available off the shelf
	Ø 130 mm	Ø 130 mm	□ 90 x 71 mm for CP 40, steel, the enclosure may optionally be mounted directly on a rotatable wall mounting
	1/top Bottom by rotating the enclosure, optional off-centre support arm connection, pre-formed	1/top Bottom by rotating the enclosure, optional off-centre support arm connection, pre-formed	1/top Bottom by rotating the enclosure
	Depends on the enclosure, from the front or rear	From the rear	From the rear, hinged rear panel
	Lock inserts may be replaced individually	Lock inserts may be replaced individually	Screw-fastened
	Interior installation bracket with system punchings for configuration with punched sections with mounting flanges 14 x 39 mm on a 25 mm pitch pattern. Simple machining of the front panel for installing machine controllers, industrial PCs or switches.	Retainer for desktop TFT with VESA 75/100 locator up to 24" in the formats 16:9/16:10	The customer's own front panels (2 – 6 mm) are easily inserted from the rear and secured with screw clamps
	178	180	181

Comfort Panel



System accessories Page 877 Support arm systems Page 183 Stand systems Page 211 Industrial Workstations Page 166

Material:

- Enclosure: Extruded aluminium section
- Corner pieces: Die-cast zinc
- Corner protectors: Plastic

Colour:

- Enclosure: Natural anodised
- Corner pieces: RAL 7035
- Corner protectors: similar to RAL 7024

Protection category IP to IEC 60 529:

- IP 65

Protection category NEMA:

- NEMA 12

Supply includes:

- Seals and assembly parts for front panels

Note:

- The support arm connection may be swapped over by rotating the enclosure

Approvals:

- UL
- cUL

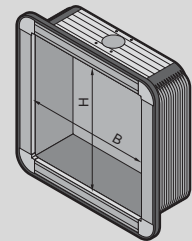

For front panel width (B) mm	Packs of	520			520		520		Page
For front panel height (H) mm		400			500		600		
Installation depth mm		74	152	191	152	191	152	191	
Model No.	1 pc(s).	6372.541	6372.542	6372.543	6372.552	6372.553	6372.562	6372.563	
Weight kg		7.8	11.7	13.8	12.3	15.2	13.5	16.7	

Design

Support arm connection □ 120 x 65 mm		■	-	-	-	-	-	-	
Support arm connection Ø 130 mm		-	■	■	■	■	■	■	
Hinged rear panel on the long side, with screw lock		■	-	-	-	-	-	-	
Hinged rear panel on the hinged long side, with cam ¹⁾		-	■	-	■	-	■	-	
Screw-fastened rear panel ²⁾		-	-	■	-	■	-	■	

Accessories





Front panel	1 pc(s).	6028.014	6028.014	6028.014	6028.015	6028.015	6028.016	6028.016	1107
Cover plate for support arm connection	1 pc(s).	6505.100	6505.500	6505.500	6505.500	6505.500	6505.500	6505.500	1107
Mounting bracket for interior installation	4 pc(s).	6205.100	6205.100	6205.100	6205.100	6205.100	6205.100	6205.100	1000
Spring nut M5	50 pc(s).	6108.000	6108.000	6108.000	6108.000	6108.000	6108.000	6108.000	1003
Earthing plate	1 pc(s).	2570.500	2570.500	2570.500	2570.500	2570.500	2570.500	2570.500	1034

¹⁾ With 3 mm double-bit lock insert, may be exchanged for 41 mm lock inserts, version C, see page 941,

plastic handles and T handles, version C, see page 942, 943

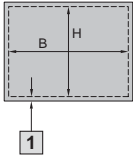
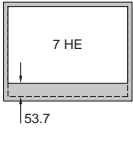
²⁾ Enclosure hinged at the front with side double-bit lock insert, may be exchanged for 41 mm lock inserts, version C, see page 941, plastic handles and T handles, version C, see page 942, 943

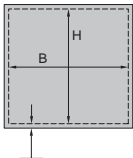
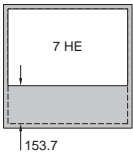
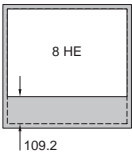
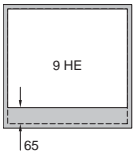
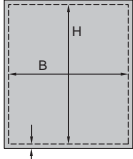
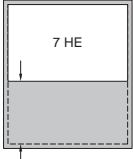
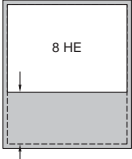
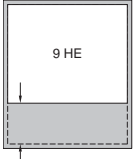
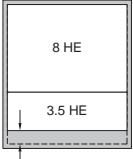
Configuration examples

Front panel height mm	Cut-out dimensions						
400							
500							
600							

↑ ↓ Free space, available for individual installed equipment such as rows of switches etc.

HE = U

Optipanel



System accessories Page 877 **Support arm systems** Page 183 **Stand systems** Page 211 **Industrial Workstations** Page 166

Material:

- Enclosure: Extruded aluminium section
- Corner pieces: Die-cast zinc
- Corner protector: Plastic

Colour:

- Enclosure: Natural anodised
- Corner pieces: RAL 7035
- Corner protectors: similar to RAL 7024

Protection category IP to IEC 60 529:

- IP 65

Protection category NEMA:

- NEMA 12

Supply includes:

- Seals

Note:

- The support arm connection may be swapped over by rotating the enclosure

Approvals:

- UL
- cUL

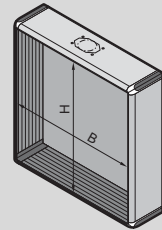

	Packs of	430	482.6	482.6	520		520	520	Page
For front panel width (B) mm									
For front panel height (H) mm		343	310.3	354.8	400		500	600	
Installation depth mm		100	100	100	100	150	150	150	
Model No.	1 pc(s).	6380.020¹⁾	6380.000	6380.040¹⁾	6380.400	6380.410	6380.510	6380.610	
Weight kg		5.3	6.2	6.6	5.8	7.3	8.3	9.2	

Design

Support arm connection □ 120 x 65 mm		■	■	■	■	-	-	-	
Support arm connection Ø 130 mm		-	-	-	-	■	■	■	
Hinged rear panel on the hinged long side ²⁾		■	■	■	■	■	■	■	
Seals and assembly parts for front panels		-	-	-	■	■	■	■	

Accessories

Front panel	1 pc(s).	-	6028.010	-	6028.014	6028.014	6028.015	6028.016	1107
Cover plate for support arm connection	1 pc(s).	6505.100	6505.100	6505.100	6505.100	6505.500	6505.500	6505.500	1107
Handle set, horizontal	1 pc(s).	-	6385.010	6385.010	-	-	-	-	1103
Mounting bracket for interior installation	4 pc(s).	6205.100	6205.100	6205.100	6205.100	6205.100	6205.100	6205.100	1000
Mounting bracket	4 pc(s).	4597.000	4597.000	4597.000	4597.000	4597.000	4597.000	4597.000	999
Earthing plate	1 pc(s).	2570.500	2570.500	2570.500	2570.500	2570.500	2570.500	2570.500	1034
Spring nut M5	50 pc(s).	6108.000	6108.000	6108.000	6108.000	6108.000	6108.000	6108.000	1003

¹⁾ To fit TFT monitors, see page 1109

²⁾ With 3 mm double-bit lock insert, may be exchanged for 41 mm lock inserts, version C, see page 941, plastic handles and T handles, version C, see page 942, 943

Configuration examples

Front panel height mm	Cut-out dimensions						
400							
		<p>B = 484 mm H = 364 mm 1 = 18 mm all-round for attaching the front panel</p>					
500							
		<p>B = 484 mm H = 464 mm 1 = 18 mm all-round for attaching the front panel</p>					
600							
		<p>B = 484 mm H = 564 mm 1 = 18 mm all-round for attaching the front panel</p>					

Free space, available for individual installed equipment such as rows of switches etc.

HE = U

Operating housings AX with handle strips



Uniform system in design and function

Modern design, adapted to support arm system CP 60/120/180

Convenience in perfection

- Integral interior installation bracket with system punchings, to match system accessories
- Fast, safe, simple servicing access from the front or rear
- Lock with integral door runners for easy locking

Built-in added value

- Support arm connection for one-person assembly
- Support arm connection \varnothing 130 mm, pre-formed off-centre in the reinforcement plate, easily drilled out

Ergonomic design

- Design strip including handle function
- Aluminium front panel, easily dismantled for machining

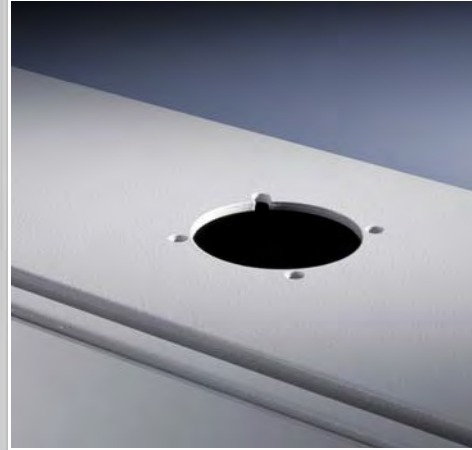

Operating housing AX with handle strips



System accessories Page 877 Support arm system Page 183 Stand systems Page 211 Operating housings with door, stainless steel Page 254

Material:

- Enclosure: Sheet steel
- Door: Sheet steel, all-round foamed-in PU seal
- Handle strips: Aluminium
- Front panel: Aluminium
- Cover caps: Plastic

Surface finish:

- Enclosure and door: Dipcoat-primed, powder-coated on the outside, textured paint
- Handle strip: Natural anodised
- Front panel: Natural anodised

Colour:

- Enclosure and door: RAL 7035
- Cover caps: similar to RAL 7024

Protection category IP to IEC 60 529:

- IP 55

Protection category NEMA:

- NEMA 12

Supply includes:

- Enclosure with door, cut-out and reinforcement for support arm connection $\text{Ø} 130 \text{ mm}$
- Front with maximum cut-out, covered with easily machinable 3 mm aluminium front panel
- Side handle strips and cover caps
- Integral interior installation bracket with system punchings
- Cam lock with 3 mm double-bit insert

Note:

- The support arm connection and door hinge may be swapped over by rotating the enclosure
- Optional: Support arm connection $\text{Ø} 130 \text{ mm}$, pre-formed off-centre in the reinforcement plate, easily drilled out
- Lock systems for servicing access from the rear: Lock insert may be exchanged for mini-comfort handle AX, 27 mm lock inserts, type A
- Lock systems for servicing access from the front: Lock insert may be exchanged for 27 mm lock inserts, type A

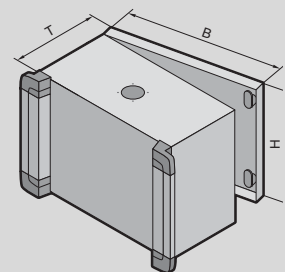
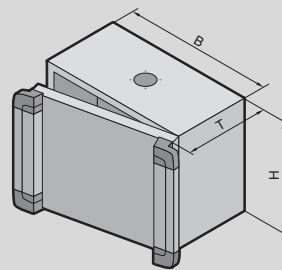

Approvals:

- UL
- cUL

Operating housing AX with handle strips

Width (B) mm	Packs of	300	300	380	380	380	Page
Height (H) mm		200	300	300	380	380	
Depth (T) mm		155	210	210	210	210	
Model No.	1 pc(s).	6320.050	6315.150	6315.250	6315.350	6320.350	
Weight, approx. kg		4.5	7.0	7.5	9.8	9.8	
Servicing access	from the rear	■	–	–	–	■	
	from the front	–	■	■	■	–	

Accessories							
Punched section with mounting flange 14 x 39 mm, installation in the height	4 pc(s).	–	–	–	8619.700	8619.700	990
Punched section with mounting flange 14 x 39 mm, installation in the width	4 pc(s).	8619.700	8619.700	–	–	–	990
Mounting bracket	4 pc(s).	4597.000	4597.000	4597.000	4597.000	4597.000	999
Mounting bracket for interior installation	4 pc(s).	6205.100	6205.100	6205.100	6205.100	6205.100	1000
Mini-comfort handle AX for lock inserts or profile half-cylinders	1 pc(s).	2537.100	2537.100	2537.100	2537.100	2537.100	940
Mini-comfort handle AX for padlock and lock inserts or profile half-cylinders	1 pc(s).	2537.300	2537.300	2537.300	2537.300	2537.300	940
Lock inserts		see page	see page	see page	see page	see page	941, 942
Earth straps		see page	see page	see page	see page	see page	1033

Width (B) mm	Packs of	500	500	600	600	600	Page
Height (H) mm		500	500	380	600	600	
Depth (T) mm		210	210	210	210	210	
Model No.	1 pc(s).	6315.450	6320.450	6320.550	6320.650	6315.650	
Weight, approx. kg		16.8	16.8	15.4	18.8	22.8	
Servicing access	from the rear	–	■	■	■	–	
	from the front	■	–	–	–	■	

Accessories							
Punched section with mounting flange 14 x 39 mm, installation in the height	4 pc(s).	8619.710	8619.710	8619.700	8619.720	8619.720	990
Punched section with mounting flange 14 x 39 mm, installation in the width	4 pc(s).	8619.720	8619.720	8619.760	8619.760	8619.760	990
Mounting bracket	4 pc(s).	4597.000	4597.000	4597.000	4597.000	4597.000	999
Mounting bracket for interior installation	4 pc(s).	6205.100	6205.100	6205.100	6205.100	6205.100	1000
Mini-comfort handle AX for lock inserts or profile half-cylinders	1 pc(s).	2537.100	2537.100	2537.100	2537.100	2537.100	940
Mini-comfort handle AX for padlock and lock inserts or profile half-cylinders	1 pc(s).	2537.300	2537.300	2537.300	2537.300	2537.300	940
Lock inserts		see page	see page	see page	see page	see page	941, 942
Earth straps		see page	see page	see page	see page	see page	1033

Rittal – The System.



Support arm system
CP 60/120/180

see page 183

Operating housing AX for desktop TFT up to 24"



System accessories Page 877 Support arm systems Page 183 Stand systems Page 211

For the installation of commercially available desktop TFTs with a screen diagonal of up to 24" in the formats 16:9/16:10.

Material:

- Enclosure: Sheet steel
- Door: Sheet steel, all-round foamed-in PU seal
- Handle strips: Aluminium
- Cover caps: Plastic
- Viewing window: Single-pane safety glass
- TFT holder: Sheet steel

Surface finish:

- Enclosure and door: Powder-coated on the outside, textured paint
- Handle strip: Natural anodised

Colour:

- Enclosure and door: RAL 7035
- Cover caps: similar to RAL 7024

Protection category IP to IEC 60 529:

- IP 65

Protection category NEMA:

- NEMA 12

Supply includes:

- Enclosure with door, cut-out and reinforcement for support arm connection \varnothing 130 mm
- Viewing window, single-pane safety glass
- Holder for desktop TFT with VESA 75/100 locator
- Side handle strips and cover caps
- Rear door with r/h hinge
- Cam lock with 3 mm double-bit insert

Note:

- The support arm connection and door hinge may be swapped over by rotating the enclosure
- Optional: Support arm connection \varnothing 130 mm, pre-formed off-centre in the reinforcement plate, easily drilled out
- Lock insert may be exchanged for mini-comfort handle AX, 27 mm lock inserts, type A

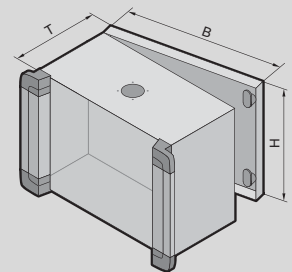

Approvals:

- UL
- cUL

Width (B) mm	Packs of	650	Page
Height (H) mm		450	
Depth (T) mm		155	
Model No.	1 pc(s).	6321.050	
Weight, approx. kg		18,0	
Cam lock		2	
Accessories			
Mini-comfort handle AX for lock inserts or profile half-cylinders	1 pc(s).	2537.100	940
Mini-comfort handle AX for padlock and lock inserts or profile half-cylinders	1 pc(s).	2537.300	940
Lock inserts		see page	941, 942



System accessories Page 877 **Support arm systems** Page 183 **Stand systems** Page 211

For small operating units built into front panels. The front panel is inserted from the rear and secured with screw clamps. Special front panels with a material thickness of between 2 and 6 mm are possible. Rear panel optionally hinged on the left or right. Roof tray with cut-out and reinforcement for support arm system CP 40 steel.

Design:

- With support arm connection 90 x 71 mm for CP 40, steel

Material:

- Roof tray, base tray: Die-cast zinc
- Rear panel: Aluminium
- Side parts: Extruded aluminium section
- Screw cover: Plastic

Surface finish:

- Roof tray, base tray, side parts: Powder-coated
- Rear panel: natural anodised

Colour:

- RAL 7024

Protection category IP to IEC 60 529:

- IP 65

Protection category NEMA:

- NEMA 12

Supply includes:

- Roof tray
- Base tray
- Rear panel
- Side parts
- Screw cover
- Seal and screw clamp

Width mm	Packs of	241	241	315	315	Page
Height mm		238	388	238	388	
Depth mm		87	87	87	87	
To fit front panel width mm		178	178	252	252	
To fit front panel height mm		200	350	200	350	
Model No.	1 pc(s).	6340.000	6340.100	6340.300	6340.400	
Weight kg		2.8	3.8	3.4	4.5	
Accessories						
Front panel	1 pc(s).	6028.500	6028.510	6028.530	6028.540	1107
Wall mounting bracket	2 pc(s).	6341.000	6341.000	6341.000	6341.000	969
Spring nut M5	50 pc(s).	6108.000	6108.000	6108.000	6108.000	1003
Cover plate	1 pc(s).	6505.200	6505.200	6505.200	6505.200	1107

Rittal – The System.

Faster – better – everywhere.



Support arm systems

Support arm system CP 40

Component overview, steel.....	185
Support section CP 40, steel.....	186
Components CP 40, steel.....	187
Component overview, stainless steel.....	188
Support section CP 40, stainless steel.....	188
Components CP 40, stainless steel.....	189

Support arm system CP 60

Component overview.....	193
Support section CP 60.....	194
Components CP 60.....	195

Support arm system CP 120

Component overview.....	197
Support section CP 120.....	198
Components CP 120.....	199

Support arm system CP 180

Component overview.....	201
Support section CP 180.....	202
Components CP 180.....	203

Support arm system CP

Support section, height-adjustable.....	206
---	-----

Load information

Comparison of support arm systems

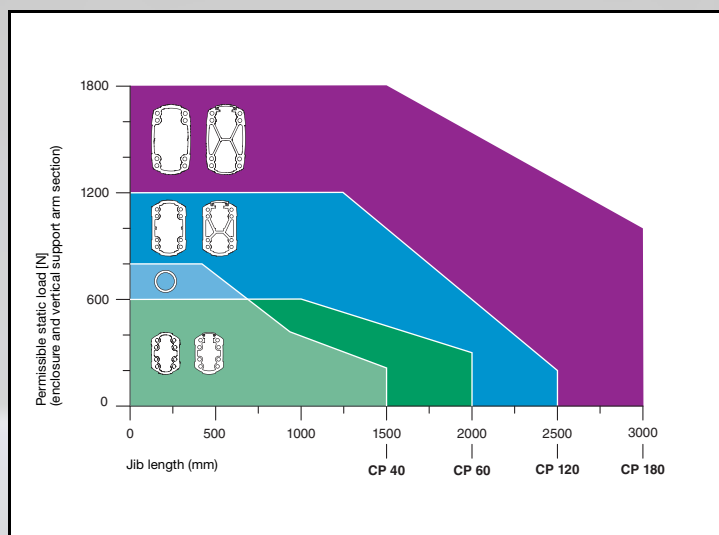

Support arm configurator

The support arm configurator determines the correct support arm system according to user-specific parameters.

More detailed information can be found at: www.rittal.com

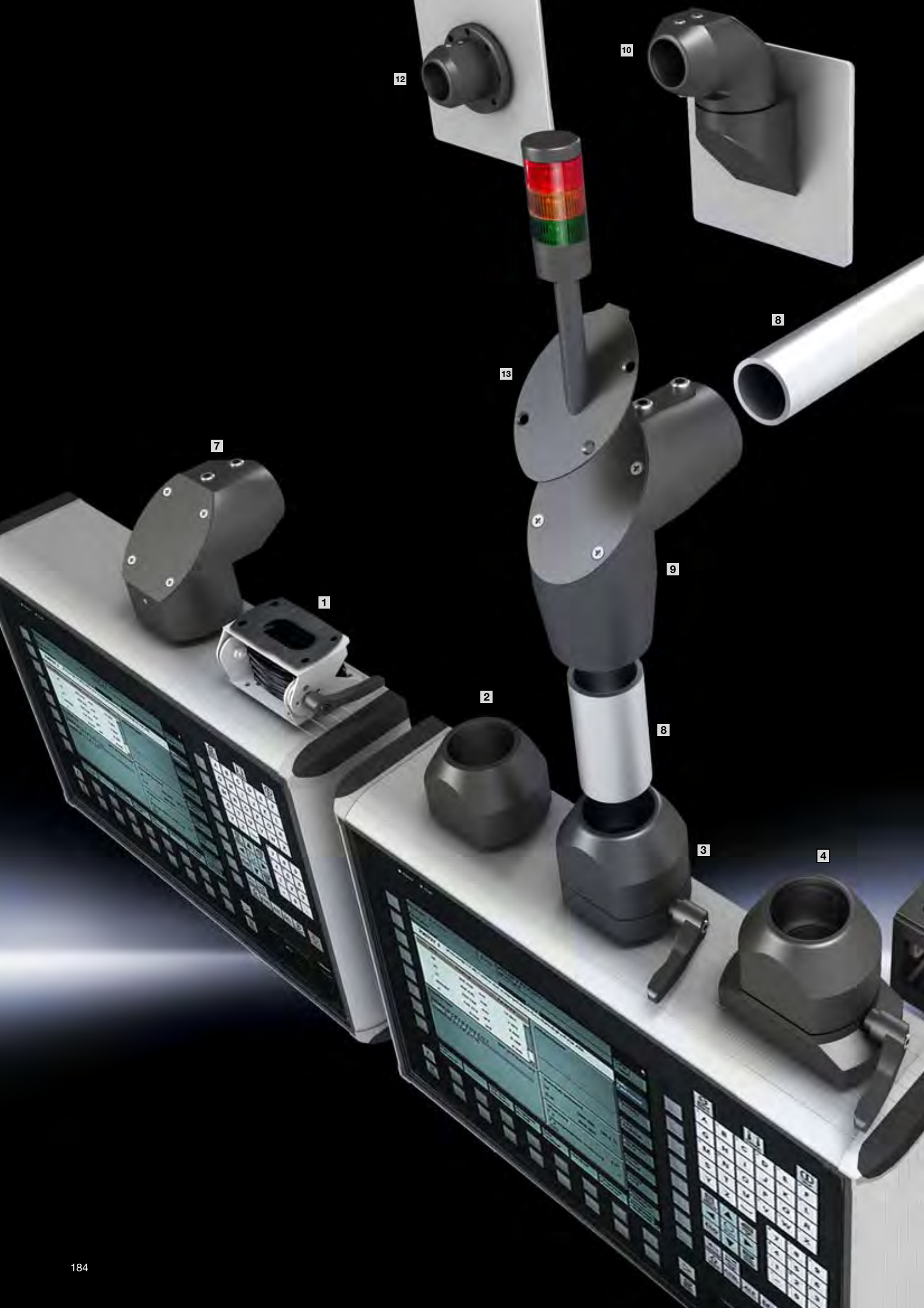

12

10

8

13

7

1

2

9

8

3

4

Support arm system CP 40, steel

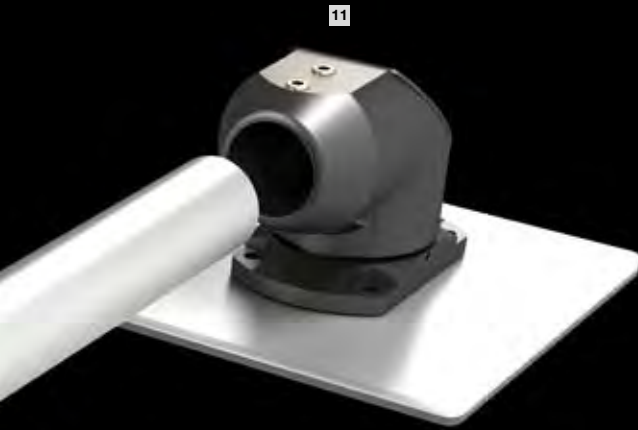

Component overview

- 1 Tilting adaptor +100/-60° for support arm connection □ 120 x 65 mm/
□ 90 x 71 mm (6206.460)
- 2 Attachment CP 40, steel, for support arm connection □ 90 x 71 mm
(6501.070)
- 3 Coupling CP 40, steel, for support arm connection □ 90 x 71 mm
(6501.050)
- 4 Coupling CP 40, steel, for support arm connection □ 120 x 65 mm
(6501.130)
- 5 Connection console VESA 75/100 for support arm connection
□ 120 x 65 mm (6206.480)
- 6 Connection console for support arm connection □ 120 x 65 mm
(6206.490)
- 7 Angle coupling 90° CP 40, steel (6501.120)
- 8 Support section CP 40, steel (6501.000, 6501.020)
- 9 Angle piece 90° CP 40, steel (6501.140)
- 10 Wall-mounted hinge CP 40, steel (6501.150)
- 11 Top-mounted joint CP 40, steel (6501.160)
- 12 Wall/base mounting bracket CP 40, steel (6501.110)
- 13 Mounting components CP 40, steel, for signal pillar (2375.030)

Load information

When using support arm system CP 40, steel in conjunction with support arm system CP 60 (in the horizontal run of the system), the load diagram for support arm system CP 60 applies.

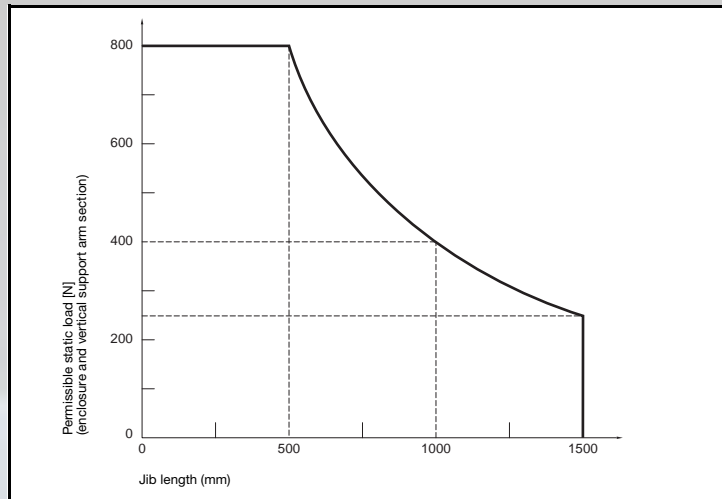

Support arm system CP 40, steel



Comfort Panel Page 172 Optipanel Page 174 Compact Panel Page 181 Operating housings AX with handle strips Page 178

Support section CP 40, steel

Attached to the connection components via 2 clamping screws

Size:

- Outer diameter: 48.3 mm
- Wall thickness: 4.0 mm

Material:

- Steel conduit, powder-coated

Colour:

- RAL 7035

Protection category IP to IEC 60 529:

- IP 54

Supply includes:

- Support section, steel

Note:

- Stainless steel, see page 188

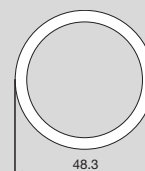

Integral adjustment facility

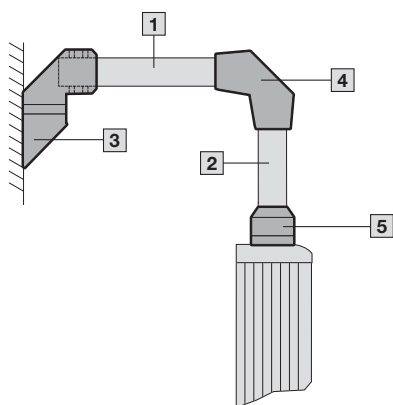

Combination with support arm system CP 60

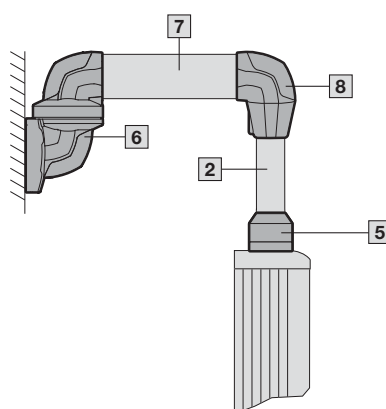



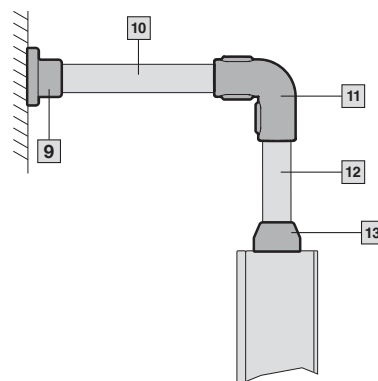









Also available in stainless steel version, see page 188

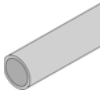

- 1 Support section CP 40, steel, 1000 mm (6501.020)
- 2 Support section CP 40, steel, 500 mm (6501.000)
- 3 Wall-mounted hinge CP 40, steel (6501.150)
- 4 Angle piece 90° CP 40, steel (6501.140)
- 5 Coupling CP 40, steel (6501.050)
- 6 Wall-mounted hinge CP 60 (6206.740)
- 7 Support section CP 60, 1000 mm (6206.100)
- 8 Angle adaptor 90° for support arm combination CP 60/40 (6206.640)
- 9 Wall/base mounting bracket, rigid, CP 40, stainless steel (6663.000)
- 10 Support section CP 40, stainless steel, 1000 mm (6660.010)
- 11 Angle piece 90° CP 40, stainless steel (6664.300)
- 12 Support section CP 40, stainless steel, 500 mm (6660.050)
- 13 Housing coupling CP 40, stainless steel (6664.000)

Support arm system CP 40, steel

	Rotating/tilting	Fixed	Length mm	Weight kg	Colour RAL	Enclosure section	Desk section	Wall section
						Model No.		
Tilting adaptor +100/-60° for support arm connection □ 120 x 65 mm/□ 90 x 71 mm								
 see page 209	■	-	-	0.8	7035/ 7024	6206.460	-	-
Attachment CP 40, steel, for support arm connection □ 90 x 71 mm								
	-	■	-	1.0	7024	6501.070	-	-
Coupling CP 40, steel, for support arm connection □ 90 x 71 mm								
	■	-	-	1.1	7024	6501.050	-	-
Coupling CP 40, steel, for support arm connection □ 120 x 65 mm								
	■	-	-	1.5	7024	6501.130	-	-
Connection console VESA 75/100 for support arm connection □ 120 x 65 mm								
 see page 207	-	■	-	1.1	7035/ 7024	6206.480	-	-
Connection console for support arm connection □ 120 x 65 mm								
 see page 207	-	■	-	0.7	7035/ 7024	6206.490	-	-
Angle coupling 90° CP 40, steel, for support arm connection □ 90 x 71 mm								
	■	-	-	1.6	7024	6501.120	-	-
Support section CP 40, steel								
	-	-	500 1000	2.1 4.2	7035 7035		6501.000 6501.020	
Angle piece 90° CP 40, steel								
	-	■	-	1.1	7024	6501.140	-	6501.140
Top-mounted joint CP 40, steel								
	■	-	-	1.8	7024	-	-	6501.160
Wall-mounted hinge CP 40, steel								
	■	-	-	2.2	7024	-	-	6501.150
Wall/base mounting bracket CP 40, steel								
	-	■	-	0.7	7024	-	-	6501.110
Mounting component CP 40, steel, for signal pillar								
 see page 1125	-	■	-	0.3	7024	2375.030	-	-
Accessories								
Angle adaptor 90° for support arm combination CP 60/40 6206.640								see page 195

Support arm system CP 40, stainless steel



Command panel housing with door, stainless steel P. 254 Premium Panel, stainless steel P. 253 Support section CP 40, steel P. 186

Support section CP 40, stainless steel

Attached to the connection components via 2 clamping screws

Size:

- Outer diameter: 48.3 mm
- Wall thickness: 3.6 mm

Material:

- Stainless steel

Surface finish:

- Brushed, grain size 400 (support section and wall console only)

Protection category IP to IEC 60 529:



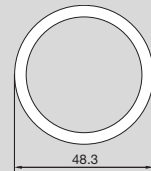

- IP 66
- IP X9

Supply includes:

- Support section, stainless steel

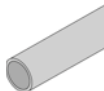
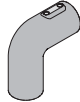

Support arm system CP 40, stainless steel

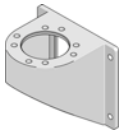
	Rotating/tilting	Rigid	Length mm	Weight kg	Material	Enclosure section	Desk section	Wall section
						Model No.		
	-	■	-	0.7	1.4305 (AISI 303)	6664.100	-	-
	-	■	-	1.3	1.4305 (AISI 303)	6664.500	-	-
	■	-	-	1.1	1.4305 (AISI 303)	6664.000	-	-
	-	■	500 1000	2.0 3.9	1.4301 (AISI 304)	6660.050 6660.010		
	-	■	-	1.3	1.4301 (AISI 304)	6664.300	-	6664.300
	-	■	-	1.7	1.430 (AISI 303)	-	-	6663.000
	■	-	-	3.9 4.5	1.430 (AISI 303)	-	-	6663.500 6663.400
	-	■	-	1.5 1.8	1.4301 (AISI 304)	-	-	6665.000 6665.500

Load information

Permissible load depending on system configuration

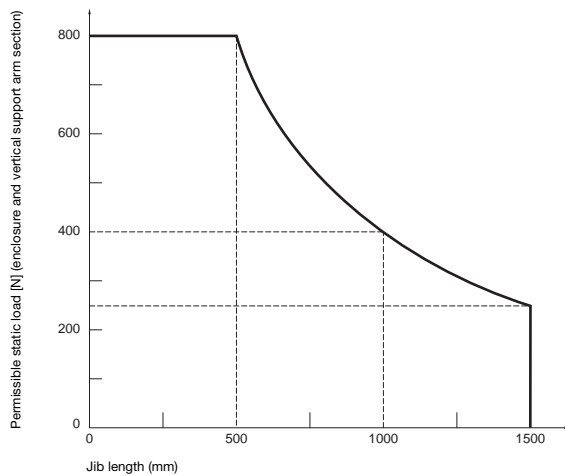

Support arm system CP 60/120/180



Uniform engineering

- All load levels up to 1800 N
- One system
- Simple system replacement in the vertical axis to cut costs and weight
- Consistent combination options

Multi-functional assembly

- Uniform adjustment principle, even retrospectively without dismantling
- Perfect limitation of rotation ranges
- Simple, one-person installation
- Sections are easily cut to the required length

Efficient cable management

- Cross-section sufficient for large connectors
- Supports simple separation between data and power cables
- Flexible cable entry and routing options
- Automatic, consistent potential equalisation of all support arm components
- Open support section for easy upgrade and servicing access

Consistent protection category

- Consistent protection category of all components, even with adaptations

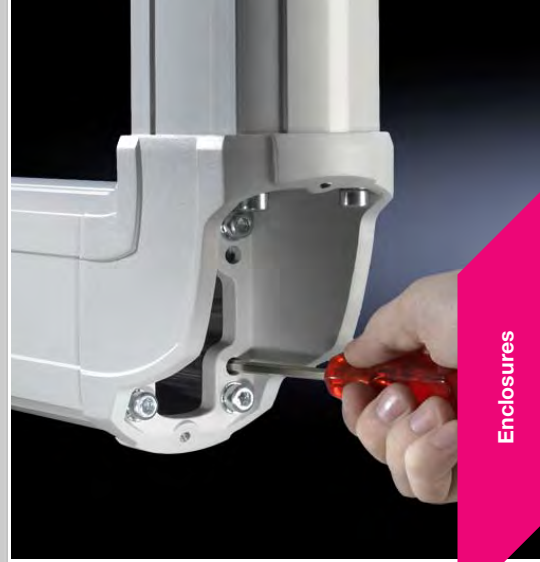

Enclosures





Support arm system CP 60

Component overview

- 1 Tilting adaptor 10° for support arm connection Ø 130 mm (6206.400)
- 2 Tilting adaptor 10° for support arm connection □ 120 x 65 mm (6206.440)
- 3 Tilting adaptor +/-45° for support arm connection Ø 130 mm (6206.420)
- 4 Tilting adaptor +100°/-60° for support arm connection □ 120 x 65 mm (6206.460)
- 5 Connection console VESA 75/100 for support arm connection □ 120 x 65 mm (6206.480)
- 6 Coupling CP 60 for support arm connection Ø 130 mm (6206.320)
- 7 Attachment CP 60 for support arm connection □ 120 x 65 mm (6206.360)
- 8 Coupling CP 60 for support arm connection Ø 130 mm (6206.300)
- 9 Coupling CP 60 for support arm connection □ 120 x 65 mm (6206.340)
- 10 Angle coupling 90° CP 60 for support arm connection Ø 130 mm (6206.380)
- 11 Support section CP 60, closed (6206.025, 6206.050, 6206.100, 6206.200)
- 12 Support section CP 60, open (6206.110)
- 13 Angle adaptor 90° for support arm combination CP 60/40 (6206.640)
- 14 Support section CP 40, steel (6501.000)
- 15 Coupling CP 40, steel, for support arm connection □ 90 x 71 mm (6501.050)
- 16 Angle piece 90° CP 60 (6206.600)
- 17 Intermediate hinge CP 60 (6206.620)
- 18 Top-mounted joint CP 60, horizontal outlet (6206.700)
- 19 Wall-mounted hinge CP 60, horizontal outlet (6206.740)
- 20 Wall/base mounting bracket CP 60, small (6206.820)
- 21 Wall/base mounting bracket CP 60, large (6206.800)
- 22 Mounting component CP 60 for signal pillar (6206.900)



Load information

Permissible load depending on system configuration

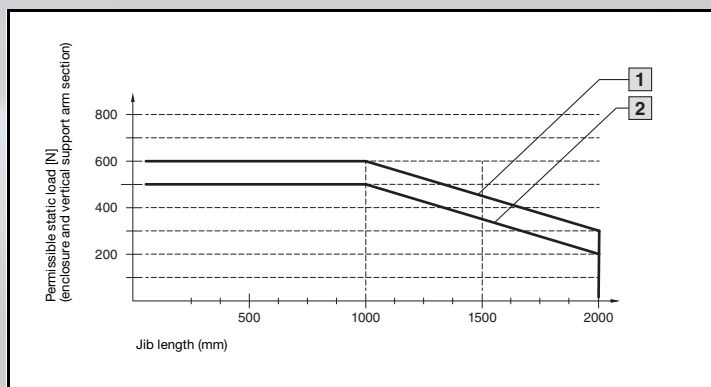

- 1 System configuration without intermediate hinge 6206.620
- 2 System configuration with intermediate hinge 6206.620

Note:

- Wall/base mounting bracket, small 6206.820 must not be used in conjunction with intermediate hinge 6206.620!
- Intermediate hinge 6206.620 should only be used once per system!

Support arm system CP 60



Comfort Panel Page 172 Optipanel Page 174 Compact Panel Page 181 Operating housings AX with handle strips Page 178

Support section CP 60

Attachment to the connection components with 4 self-tapping screws in the screw channel. May be cut to any required length, no thread-tapping required. Closed cable duct with a large cross-section. Open cable duct for easy servicing access and for pre-assembled cables with connectors; lockable via cover section.

Size:

- External dimensions: 59 x 85 mm

Material:

- Support section: Extruded aluminium section

Colour:

- Support section: RAL 7035

Protection category IP to IEC 60 529:

- IP 54

Supply includes:

- Support section

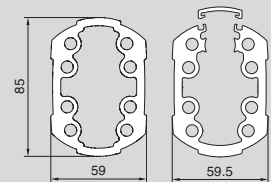

Combination with support arm system CP 40

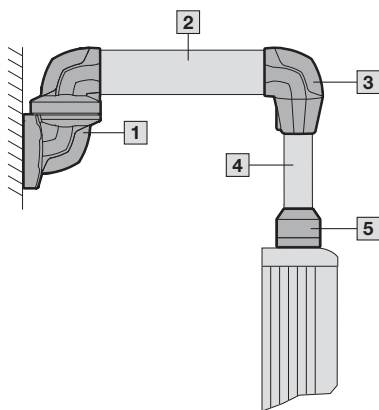

Combination with support arm system CP 120

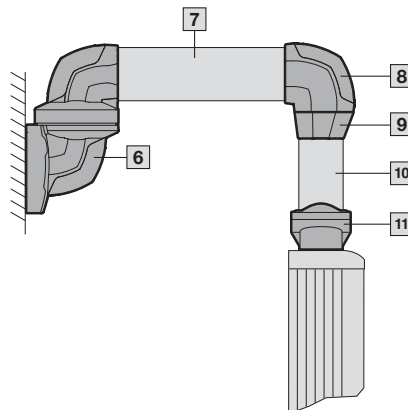



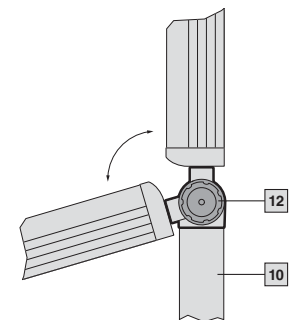





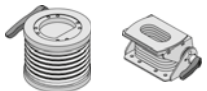



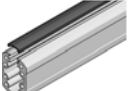

Roof plate with tilt coupler, see page 210

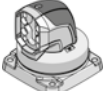

- 1 Wall-mounted hinge CP 60, horizontal outlet (6206.740)
- 2 Support section CP 60, 1000 mm (6206.100)
- 3 Angle adaptor 90° for support arm combination CP 60/40 (6206.640)
- 4 Support section CP 40, steel, 500 mm (6501.000)
- 5 Coupling CP 40, steel, for support arm connection □ 120 x 65 mm (6501.130)
- 6 Wall-mounted hinge CP 120, horizontal outlet (6212.740)
- 7 Support section CP 120, 1000 mm (6212.100)
- 8 Angle piece 90° CP 120 (6212.600)
- 9 Adaptor for support arm combination CP 120/60 (6212.640)
- 10 Support section CP 60, 500 mm (6206.050)
- 11 Coupling CP 60 for support arm connection □ 120 x 65 mm (6206.340)
- 12 Tilt coupler for support arm system CP 60/6206.350

Support arm system CP 60

	Rotating/tilting	Rigid	Length mm	Weight kg	Colour RAL	Enclosure section CP 60	Enclosure section CP 60/40	Centre section CP 60	Wall section CP 60		
Model No.											
Tilting adaptor 10° for support arm connection											
	Ø 130 mm	-	■	-	0.6	7035	6206.400	-	-	-	
	□ 120 x 65 mm	-	■	-	0.4		6206.440	-	-	-	
Tilting adaptor +/-45°, tilting adaptor +100°/-60° for support arm connection see page 209											
	Ø 130 mm	■	-	-	1.2	7024	6206.420	-	-	-	
	□ 120 x 65 mm	■	-	-	0.8	7035/7024	6206.460	6206.460	-	-	
	□ 90 x 71 mm	-	-	-	0.8		-	6206.460	-	-	
Connection console VESA 75/100 for support arm connection see page 207											
	□ 120 x 65 mm	-	■	-	1.1	7035/7024	6206.480	-	-	-	
Attachment CP 60/40 for support arm connection											
	Ø 130 mm	-	■	-	0.7	7035	6206.320	-	-	-	
	□ 120 x 65 mm	-	■	-	1.0	7035	6206.360	-	-	-	
	□ 90 x 71 mm	-	-	-	1.0	7024	-	6501.070	-	-	
Coupling CP 60/40 for support arm connection											
	Ø 130 mm	■	-	-	2.1	7035	6206.300	-	-	-	
	□ 120 x 65 mm	■	-	-	1.2	7035	6206.340	6501.130	-	-	
	□ 90 x 71 mm	-	-	-	1.1	7024	-	6501.050	-	-	
Angle coupling 90° CP 60/40 for support arm connection											
	Ø 130 mm	■	-	-	1.8	7035/7024	6206.380	-	-	-	
Support section CP 60/40											
	Closed	-	-	250	1.25	7035	6206.025	CP 60	CP 40 ¹⁾	CP 60	CP 60
500				2.5	6206.050		-	6206.025	6206.050		
1000				5.0	6206.100		6501.000	6206.100	6206.100		
2000				10.0	6206.200		6501.020	6206.200	6206.200		
	Open	-	-	1000	5.6	7035/7024	6206.110	-	-	-	
Angle adaptor 90° for support arm combination CP 60/40											
	-	■	-	-	1.0	7035/7024	-	6206.640	-	-	
Angle piece 90° CP 60											
	-	■	-	-	0.5	7035/7024	6206.600	-	-	6206.600	
Intermediate hinge CP 60											
	■	-	-	-	2.2	7035/7024	-	-	6206.620	-	
Top-mounted joint CP 60											
	Horizontal outlet	■	-	-	2.2	7035/7024	-	-	-	6206.700	
Wall-mounted hinge CP 60											
	Horizontal outlet	■	-	-	2.85	7035/7024	-	-	-	6206.740	
Wall/base mounting bracket CP 60, small											
	-	■	-	-	0.35	7035	-	-	-	6206.820	
Wall/base mounting bracket CP 60, large											
	-	■	-	-	1.4	7035/7024	-	-	-	6206.800	
Accessories											
Mounting component for signal pillar, see page 1125/Adaptor CP 120/60 Ø 130 mm to □ 120 x 65 mm 6212.500, see page 199											

¹⁾ Weight information and diagrams for CP 40, see page 187



Support arm system CP 120

Component overview

- 1 Adaptor CP 120 from support arm connection \varnothing 130 mm to \square 120 x 65 mm (6212.500)
- 2 Attachment CP 120 for support arm connection \varnothing 130 mm (6212.320)
- 3 Coupling CP 120 for support arm connection \varnothing 130 mm (6212.300)
- 4 Coupling CP 60 for support arm connection \square 120 x 65 mm (6206.340)
- 5 Angle coupling 90° CP 120 for support arm connection \varnothing 130 mm (6212.380)
- 6 Support section CP 120, closed (6212.025, 6212.050, 6212.100, 6212.200)
- 7 Support section CP 120, open (6212.150, 6212.110, 6212.210)
- 8 Support section CP 60, closed (6206.025, 6206.050, 6206.100, 6206.200)
- 9 Adaptor for support arm combination CP 120/60 (6212.640)
- 10 Angle piece 90° CP 120 (6212.600)
- 11 Intermediate hinge CP 120, without height offset (6212.680)
- 12 Intermediate hinge CP 120, with height offset (6212.620)
- 13 Top-mounted joint CP 120, vertical outlet (6212.720)
- 14 Top-mounted joint CP 120, horizontal outlet (6212.700)
- 15 Wall-mounted hinge CP 120, vertical outlet (6212.760)
- 16 Wall-mounted hinge CP 120, horizontal outlet, without height offset (6212.780)
- 17 Wall-mounted hinge CP 120, horizontal outlet, with height offset (6212.740)
- 18 Wall/base mounting bracket CP 120, small (6212.820)
- 19 Wall/base mounting bracket CP 120, large (6212.800)
- 20 Mounting component CP 120/180 for signal pillar (6212.900)

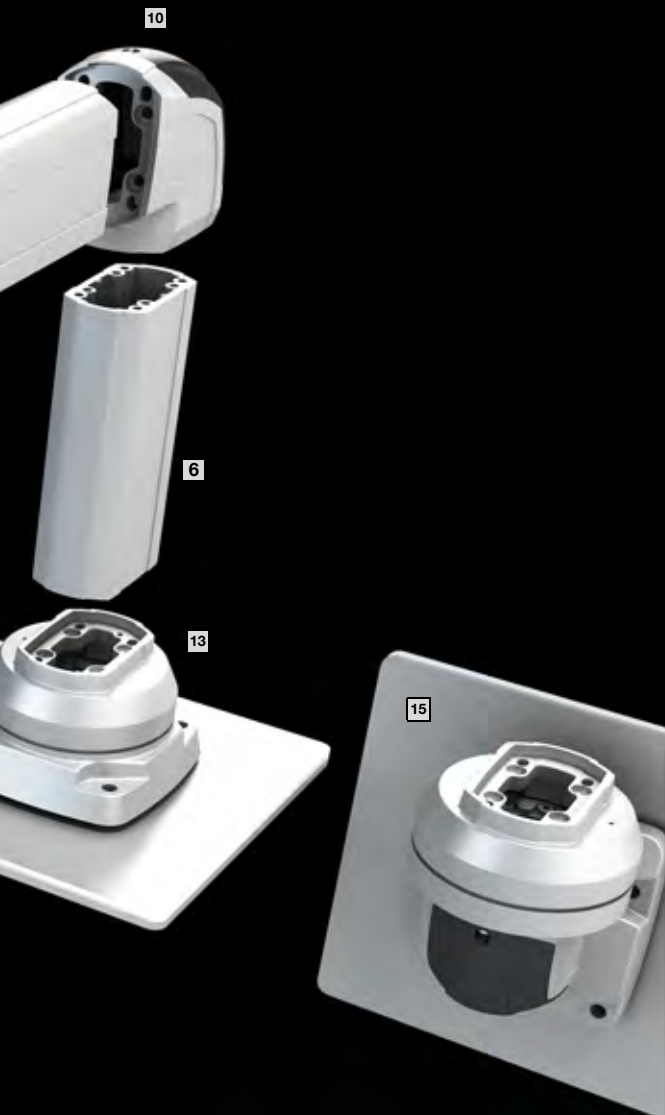

Load information

Permissible load depending on system configuration

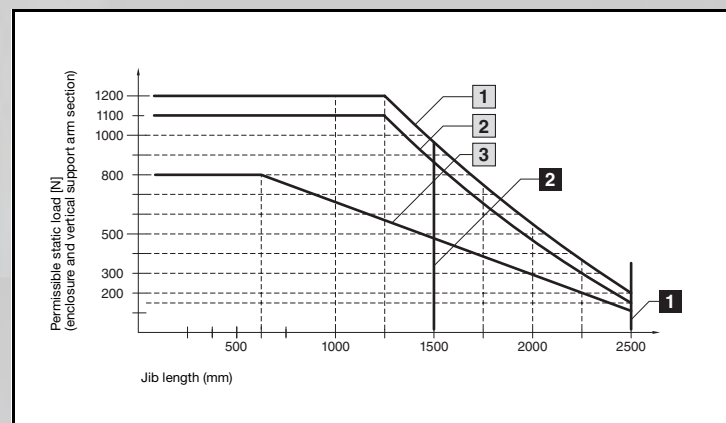

- 1 System configuration without intermediate hinge 6212.620/.680, with closed or open support section
- 2 System configuration with intermediate hinge 6212.620/.680 and closed support section
- 3 System configuration with intermediate hinge 6212.620/.680 and open support section
- 1 Maximum system length 2500 mm for systems with horizontal outlet at the system start
- 2 Maximum system length 1500 mm for systems with vertical outlet at the system start. The overall height at the vertical system start must not exceed 500 mm.

Note:

- Wall/base mounting bracket, small 6212.820 must not be used in conjunction with intermediate hinge 6212.620/.680!
- Intermediate hinge 6212.620/.680 should only be used once per system!

Support arm system CP 120



Comfort Panel P. 172 Optipanel P. 174 Operating housings AX with handle strips P. 178 Operating housing AX for desktop TFT P. 180

Support section CP 120

Attachment to the connection components with 4 self-tapping screws in the screw channel. May be cut to any required length, no thread-tapping required. Closed cable duct with a large cross-section. Open cable duct for easy servicing access and for pre-assembled cables with connectors; lockable via cover section.

X-shaped profiling for greater load capacity, large cable routing channels. Upper channel adequate for cables with large connectors (e.g. DVI or VGA) and available/usable throughout the entire system.

Size:

- External dimensions:
75 x 120 mm

Material:

- Support section:
Extruded aluminium section

Colour:

- Support section: RAL 7035

Protection category IP to IEC 60 529:

- IP 54

Supply includes:

- Support section

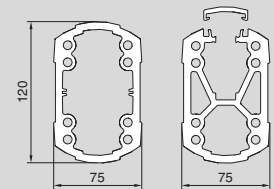

Combination with support section, height adjustable

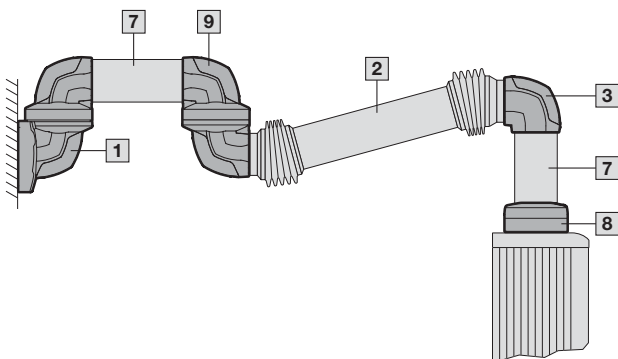
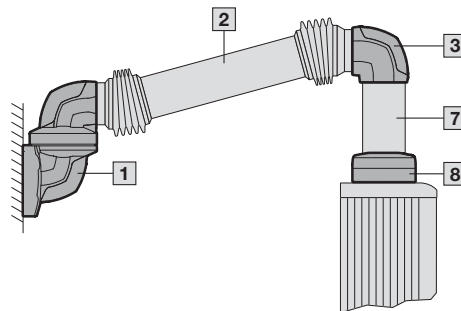
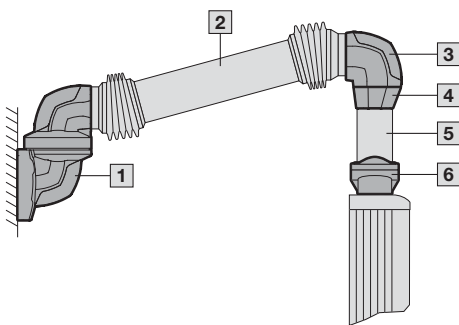

Note:

When using an intermediate hinge, the height-adjustable support section should always be inserted in the closest horizontal position to the enclosure.

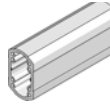
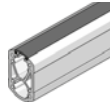

- 1 Wall-mounted hinge CP 120, horizontal outlet (6212.740)
- 2 Support section, height-adjustable (6212.120), see page 206
- 3 Angle piece 90° CP 120 (6212.600)
- 4 Adaptor for support arm combination CP 120/60 (6212.640)
- 5 Support section CP 60, L = 500 mm (6206.050)
- 6 Coupling CP 60 for support arm connection
□ 120 x 65 mm (6206.340)
- 7 Support section CP 120, closed, L = 500 mm (6212.050)
- 8 Coupling CP 120 for support arm connection Ø 130 mm (6212.300)
- 9 Intermediate hinge CP 120 (6212.620)

Support arm system CP 120

	Rotating/tilting	Rigid	Length mm	Weight kg	Colour RAL	Enclosure section CP 120	Enclosure section CP 120/60	Centre section CP 120	Wall section CP 120	
						Model No.				
Adaptor CP 120/60 from support arm connection Ø 130 mm to □ 120 x 65 mm										
	-	■	-	0.5	7035	6212.500	6212.500	-	-	
Attachment CP 120/60 for support arm connection										
	-	■	-	0.7	7035	6212.320	6206.320	-	-	
	-	■	-	0.7	7035	-	6206.360	-	-	
Coupling CP 120/60 for support arm connection										
	■	-	-	2.0	7035	6212.300	6206.300	-	-	
	-	-	-	-	-	-	6206.340	-	-	
Angle coupling 90° CP 120 for support arm connection										
	■	-	-	2.1	7035/ 7024	6212.380	-	-	-	
Support section CP 120/60						CP 120	CP 60 ¹⁾	CP 120	CP 120	
	Closed	-	-	250	2.0	7035	6212.025	6206.025	6212.025	6212.025
		-	-	500	3.9		6212.050	6206.050	6212.050	6212.050
		-	-	1000	7.8		6212.100	6206.100	6212.100	6212.100
		-	-	2000	15.6		6212.200	6206.200	6212.200	6212.200
	Open	-	-	500	4.6	7035/ 7024	6212.150	-	6212.150	6212.150
		-	-	1000	9.2		6212.110	-	6212.110	6212.110
		-	-	2000	18.4		6212.210	-	6212.210	6212.210
Adaptor for support arm combination CP 120/60										
	-	■	-	0.7	7035	-	6212.640	-	-	
Angle piece 90° CP 120										
	-	■	-	1.1	7035/ 7024	6212.600	-	-	6212.600	
Intermediate hinge CP 120										
	Without height offset	■	-	-	4.0	7035/ 7024	-	-	6212.680	-
	With height offset	■	-	-	4.4	7035/ 7024	-	-	6212.620	-
Top-mounted joint CP 120										
	Vertical outlet	■	-	-	3.8	7035	-	-	-	6212.720
	Horizontal outlet	■	-	-	4.3	7035/ 7024	-	-	-	6212.700
Wall-mounted hinge CP 120, vertical outlet										
	■	-	-	5.5	7035/ 7024	-	-	-	6212.760	
Wall-mounted hinge CP 120, horizontal outlet										
	Without height offset	■	-	-	8.3	7035/ 7024	-	-	-	6212.780
	With height offset	■	-	-	6.1	7035/ 7024	-	-	-	6212.740
Wall/base mounting bracket CP 120, small										
	-	■	-	0.5	7035	-	-	-	6212.820	
Wall/base mounting bracket CP 120, large										
	-	■	-	2.5	7035/ 7024	-	-	-	6212.800	
Accessories										
Mounting component for signal pillar, see page 1125/ Tilting adaptor for support arm connection Ø 130 mm and □ 120 x 65 mm, see page 209										

¹⁾ Weight information and diagrams for CP 60, see page 195

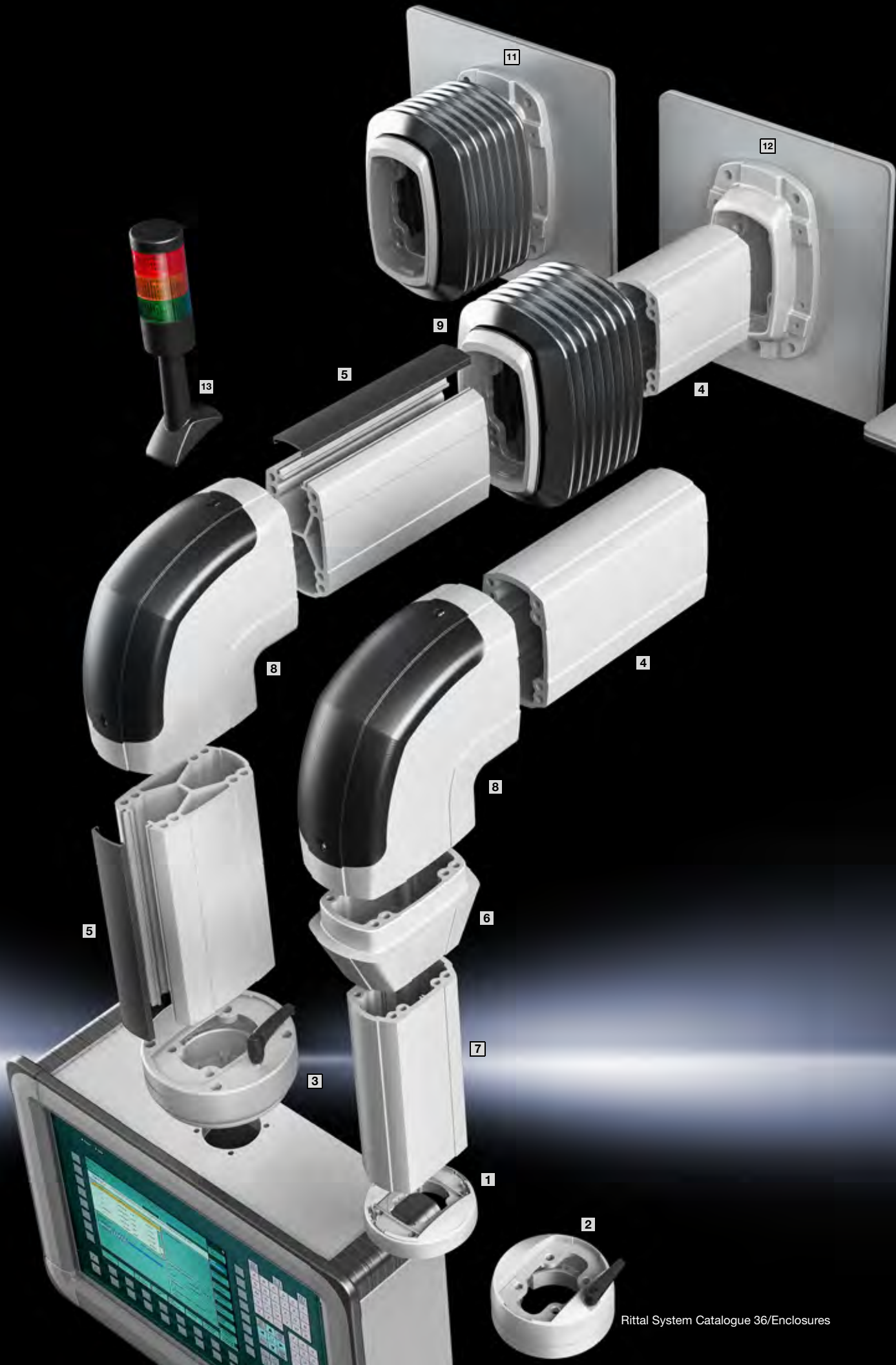

Support arm system CP 180

Component overview

- 1 Attachment CP 120 for support arm connection \varnothing 130 mm (6212.320)
- 2 Coupling CP 120 for support arm connection \varnothing 130 mm (6212.300)
- 3 Coupling CP 180 for support arm connection \varnothing 130 mm (6218.300)
- 4 Support section CPS 180, closed (6218.050, 6218.100, 6218.200)
- 5 Support section CP 180, open (6218.150, 6218.110, 6218.210)
- 6 Adaptor for support arm combination, CP 180/120 (6218.640)
- 7 Support section CP 120, closed (6212.025, 6212.050, 6212.100, 6212.200)
- 8 Angle piece 90° CP 180 (6218.600)
- 9 Intermediate hinge CP 180 (6218.620)
- 10 Top-mounted joint CP 180, horizontal outlet (6218.700)
- 11 Wall-mounted hinge CP 180, horizontal outlet (6218.740)
- 12 Wall/base mounting bracket CP 180, small (6218.820)
- 13 Mounting component CP 120/180 for signal pillar (6212.900)

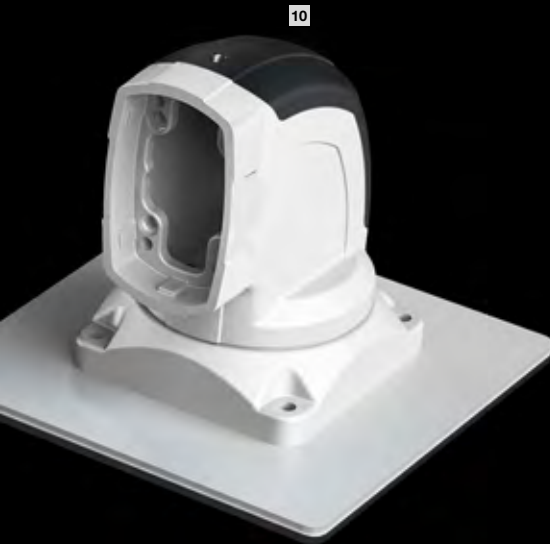

Load information

Permissible load depending on system configuration

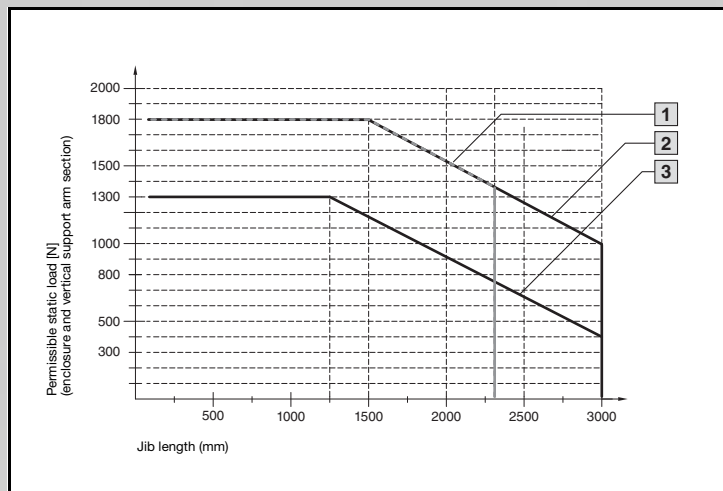

- 1 System configuration without intermediate hinge 6218.620, with closed or open support section
- 2 System configuration with intermediate hinge 6218.620 and closed support section
- 3 System configuration with intermediate hinge 6218.620 and open support section

Note:

- Intermediate hinge 6218.620 should only be used once per system!
- Where possible, Rittal recommends that the support section between components 6218.700, 6218.740, 6218.820 and intermediate hinge 6218.620 should be of a closed design

Support arm system CP 180

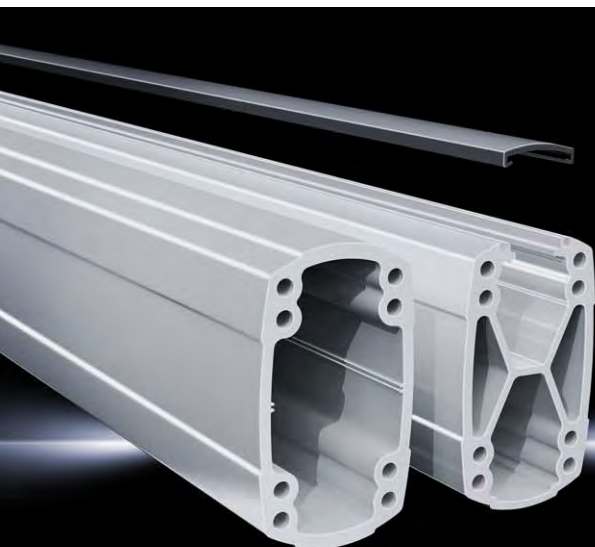

Comfort Panel P. 172 Optipanel P. 174 Operating housings AX with handle strips P. 178 Operating housing AX for desktop TFT P. 180

Support section CP 180

Attachment to the connection components with 4 self-tapping screws in the screw channel. May be cut to any required length, no thread-tapping required. Closed cable duct with a large cross-section. Open cable duct for easy servicing access and for pre-assembled cables with connectors; lockable via cover section.

X-shaped profiling for greater load capacity, large cable routing channels. Upper channel adequate for cables with large connectors (e.g. DVI or VGA) and available/usable throughout the entire system.

Size:

- External dimensions: 90 x 160 mm

Material:

- Support section: Extruded aluminium section

Colour:

- Support section: RAL 7035

Protection category IP to IEC 60 529:

- IP 54

Supply includes:

- Support section

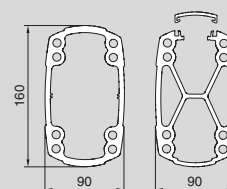

Support arm system CP 180

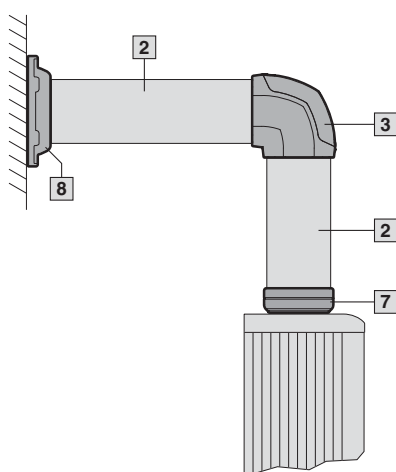



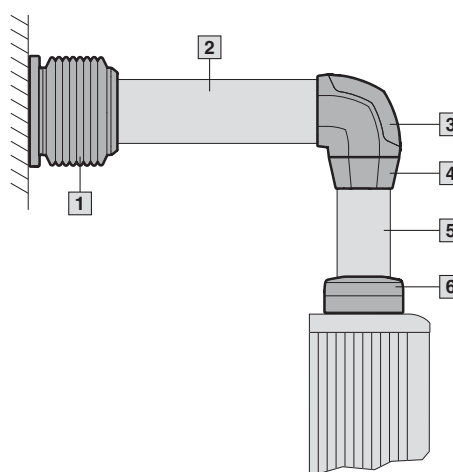





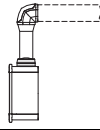

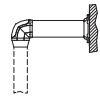

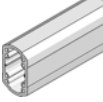
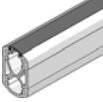

Combination with support arm system CP 120



- 1 Wall-mounted hinge CP 180, horizontal outlet (6218.740)
- 2 Support section CP 180, closed, 1000 mm (6218.100)
- 3 Angle piece 90° CP 180 (6218.600)
- 4 Adaptor for support arm combination CP 180/120 (6218.640)
- 5 Support section CP 120, closed, L = 500 mm (6212.050)
- 6 Coupling CP 120 for support arm connection Ø 130 mm (6212.300)
- 7 Coupling CP 180 for support arm connection Ø 130 mm (6218.300)
- 8 Wall/base mounting bracket CP 180, small (6218.820)

Support arm system CP 180

	Rotating/fitting	Rigid	Length mm	Weight kg	Colour RAL	Enclosure section CP 180/120	Centre section CP 180	Wall section CP 180
								
Model No.								
Adaptor from support arm connection Ø 180 mm to Ø 130 mm								
	-	■	-	0.6	7035	6212.520	-	-
Attachment CP 120 for support arm connection Ø 130 mm								
	-	■	-	0.7	7035	6212.320	-	-
Coupling CP 180/120 for support arm connection Ø 130 mm								
	■	-	-	5.3	7035	6218.300	-	-
	■	-	-	2.0		6212.300	-	-
Support section CP 180/120						CP 120 ¹⁾	CP 180	CP 180
	Closed	-	-	250	7035	6212.025	-	-
		-	-	500		6212.050	6218.050	6218.050
		-	-	1000		6212.100	6218.100	6218.100
		-	-	2000		6212.200	6218.200	6218.200
	Open	-	-	500	7035/ 7024	6212.150	6218.150	6218.150
		-	-	1000		6212.110	6218.110	6218.110
		-	-	2000		6212.210	6218.210	6218.210
		-	-	-		-	-	-
Adaptor for support arm combination CP 180/120								
	-	■	-	1.5	7035	6218.640	-	-
Angle piece 90° CP 180								
	-	■	-	3.6	7035/ 7024	6218.600	-	6218.600
Intermediate hinge CP 180								
	■	-	-	10.3	7035/ 7024	-	6218.620	-
Top-mounted joint CP 180								
	■	-	-	18.0	7035/ 7024	-	-	6218.700
Wall-mounted hinge CP 180								
	■	-	-	13.0	7035/ 7024	-	-	6218.740
Wall/base mounting bracket CP 180, small								
	-	■	-	5.0	7035	-	-	6218.820
Mounting component CP 120/180 for signal pillar								
	-	■	-	0.1	7024	6212.900	-	6212.900
Accessories								
Tilting adaptor for support arm connection Ø 130 mm and □ 120 x 65 mm, see page 209								

¹⁾ Weight information and diagrams for CP 120, see page 199

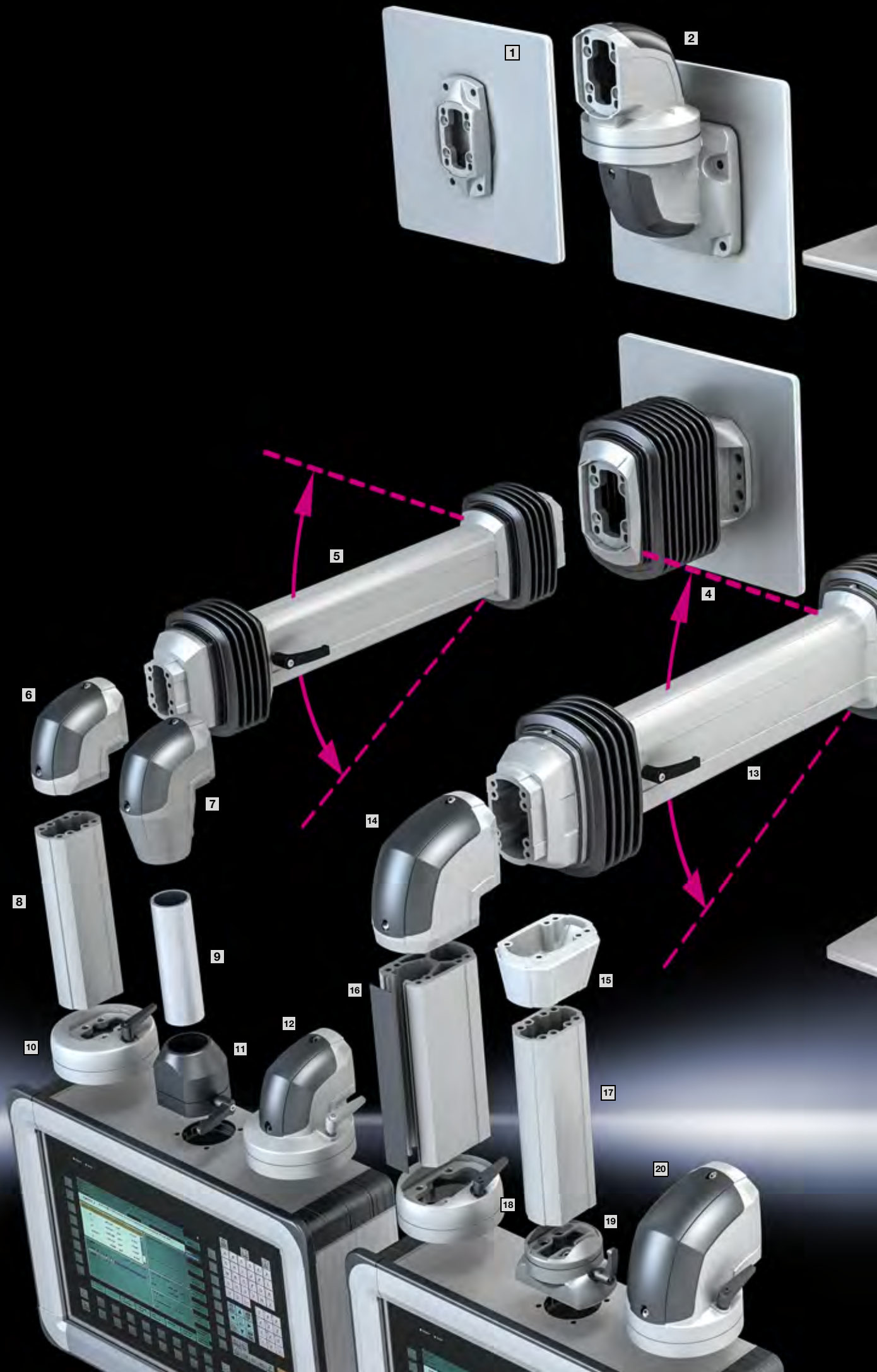

Support arm system CP

Support arm, height-adjustable

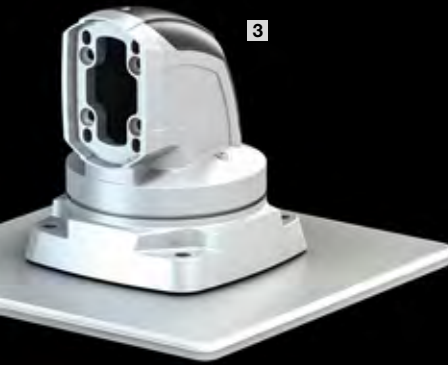

Component overview

- 1 Wall/base mounting bracket CP 120, small (6212.820)
- 2 Wall-mounted hinge CP 120, horizontal outlet, with height offset (6212.740)
- 3 Top-mounted joint CP 120, horizontal outlet (6212.700)
- 4 Wall-mounted hinge CP 120, horizontal outlet, without height offset (6212.780)
- 5 Support section, height-adjustable CP 120/CP 60 (6212.060, 6212.065)
- 6 Angle piece 90° CP 60 (6206.600)
- 7 Angle adaptor 90° for support arm combination CP 60/40 (6206.640)
- 8 Support section CP 60 (6206.110, 6206.025, 6206.050, 6206.100, 6206.200)
- 9 Support section CP 40, steel (6501.000, 6501.020)
- 10 Coupling CP 60 for support arm connection Ø 130 mm (6206.300)
- 11 Coupling CP 40, steel, for support arm connection □ 90 x 71 mm (6501.050)
- 12 Angle coupling 90° CP 60 for support arm connection Ø 130 mm (6206.380)
- 13 Support section, height-adjustable CP 120/CP 120 (6212.120)
- 14 Angle piece 90° CP 120 (6212.600)
- 15 Adaptor for support arm combination CP 120/60 (6212.640)
- 16 Support section CP 120, open (6212.150, 6212.110, 6212.210)
- 17 Support section CP 60 (6206.110, 6206.025, 6206.050, 6206.100, 6206.200)
- 18 Coupling CP 120 for support arm connection Ø 130 mm (6212.300)
- 19 Coupling CP 60 for support arm connection □ 120 x 65 mm (6206.340)
- 20 Angle coupling 90° CP 120 for support arm connection Ø 130 mm (6212.380)
- 21 Angle piece 90° CP 120 (6212.600)
- 22 Support section CP 120, closed (6212.025, 6212.050, 6212.100, 6212.200)
- 23 Top-mounted joint CP 120, vertical outlet (6212.720)

Note:

- In combination with support section, height adjustable observe:
- When using an intermediate hinge, the height-adjustable support section should always be inserted in the closest horizontal position to the enclosure.

Support arm system CP



Support section, height-adjustable

Now even more ergonomic, thanks to

- Adjustment range for tall and short operators, as well as seated and stand-up workstations:
6212.060/120: 600 mm ± 300 mm
6212.065: 950 mm ± 475 mm
- Support arm holds securely in any position
- Additional fixing with clamping lever if required
- Precise coordination to the suspended load via an adjusting screw at the front of the support section
- Adjusting screw can be accessed without dismantling any components
- Removable side panel for easy access to cable routing
- Tilt angle of the mounted enclosure is identical in every height position
- Cables with connectors such as DVI, VGA are easily inserted
- Broad weight range from 4 to 60 kg with just two systems

Maximum cross-section for cable entry:

- 17 x 41 mm for CP 6212.060/.065
- 17 x 59 mm for CP 6212.120

Colour:

- RAL 7035/7024

Protection category IP to IEC 60 529:

- IP 54

Supply includes:

- Assembly parts

Note:

For combination with support section, height-adjustable, please note:

- When using an intermediate hinge, the height-adjustable support section should always be inserted in the closest horizontal position to the enclosure

Wall/machine side	Enclosure side	Overall length mm	Weight range kg ¹⁾	Model No.
CP 120	CP 60	741	4 – 30	6212.060
CP 120	CP 60	1050	4 – 17	6212.065
CP 120	CP 120	790	10 – 60	6212.120

¹⁾ For configured enclosure and vertical support section

Cable tray

CP 6212.060/.065
30 x 10 mm (W x H)

CP 6212.120
43 x 21 mm (W x H)

Maximum connector dimensions

CP 6212.060/.065
41 x 17 mm (W x H)

CP 6212.120
59 x 17 mm (W x H)

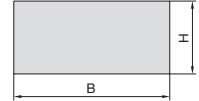
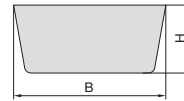

B = Width



Support arm configurator

for CP 40/60/120/180 and support section, height-adjustable

The tool determines the perfect system for your application from key user-specific parameters such as the jib length, enclosure weight or required cable cross-sections.

Benefits:

- Individual assembly tailored to the requirements of the application
- Built-in consistency check
- The outcome is a plausibility-checked parts list
- Detailed cutting dimensions for the support sections
- Free online configurator
- Simple, systematic menu prompting
- Seamless system solution
- Supply of CAD data for the configured system

Note:

- Configure online at www.rittal.com/configurators

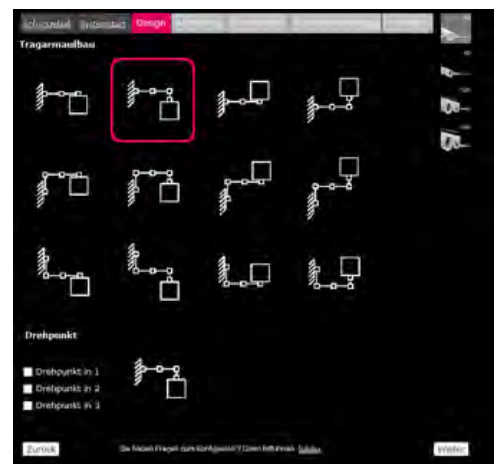

Support arm system CP 40/60/120/180

Connection console VESA 75/100

For rear connection of
 – Slimline operating housings
 – Commercially available TFTs
 – Industrial PCs
 with VESA 75/100 connection

Connection to Rittal support arm systems
 – CP 40
 – CP 60
 – CP 120 via adaptor from support arm connection
 Ø 130 mm to □ 120 x 65 mm

Benefits:

- Fast, simple one-person assembly using machined keyholes
- More space for installation and servicing
- Cables may be routed to devices outside and inside the console
- Removable cover for simple cable routing and access to interior device connections
- Integral cable clamping facilities
- Cover with captive screws

Material:

- Die-cast zinc

Colour:

- Connection console: RAL 7035
- Cover: RAL 7024

Protection category IP to IEC 60 529:

- IP 54

Supply includes:

- Connection console VESA
- Seals
- Cable ties for cable clamping
- Assembly parts

Weight kg	Model No.
1.1	6206.480



Also required:

- Attachment CP 60 for support arm connection
 □ 120 x 65 mm, 6206.360
- Coupling CP 60 for support arm connection
 □ 120 x 65 mm, 6206.340
- Tilting adaptor 10° for support arm connection
 □ 120 x 65 mm, 6206.440
- Coupling CP 40 for support arm connection
 □ 120 x 65 mm, 6501.130
- Tilting adaptor +/-45° for support arm connection
 □ 120 x 65 mm, 6206.460
- Adaptor from support arm connection Ø 130 mm
 to □ 120 x 65 mm, 6212.500

VESA connection hole pattern

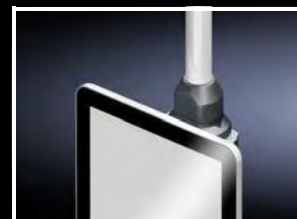
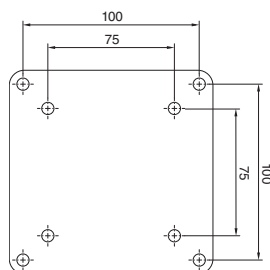

Connection console

For rear connection of slimline operating housings.
 Removable lid for simple cable entry.

Connection to Rittal support arm systems
 – CP 40
 – CP 60
 – CP 120 via adaptor from support arm connection
 Ø 130 mm to □ 120 x 65 mm

Material:

- Cast aluminium

Protection category IP to IEC 60 529:

- IP 54

Supply includes:

- Connection console
- Seals
- Assembly parts

Colour	Weight kg	Model No.
RAL 7024	0.7	6206.490



Also required:

- Coupling CP 40 for support arm connection
 □ 120 x 65 mm, 6501.130
- Attachment CP 60 for support arm connection
 □ 120 x 65 mm, 6206.360
- Coupling CP 60 for support arm connection
 □ 120 x 65 mm, 6206.340



Support arm system CP 40/60/120/180



Adaptor for Siemens Pro-Panel

Weight kg	Model No.
0.3	6206.500

For the external mounting of Siemens Simatic

- MP 377 Pro
- Thin Client 15" Pro
- Flat-Panel Monitor 15", 19" Pro
- HMI IPC477C Pro
- ThinClient Pro

Connection to support arm systems

- CP 40, steel
- CP 60/120 with support arm connection
 - 120 x 65 mm

Material:

- Aluminium

Colour:

- RAL 7035

Supply includes:

- Adaptor
- Seals
- Assembly parts

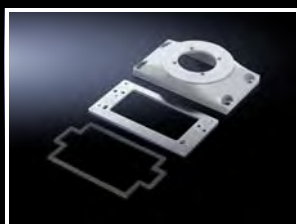

Connection plates with reinforcement plate

Weight kg	Model No.
1.4	6212.540

For easy location of the command panel onto the support arm or pedestal. More space for cable entry.

For mounting command panels

- Comfort Panel from a front panel width of 247 mm and installation depth of 152 mm
- Optipanel from a front panel width of 220 mm and installation depth of 150 mm
- Sheet steel from 135 mm installation depth

For mounting on support arm system components

- Attachment CP 60/120 for support arm connection Ø 130 mm, 6206.320, 6212.320
- Coupling CP 60/120 for support arm connection Ø 130 mm, 6206.300, 6212.300
- Angle coupling 90° CP 60/120 for support arm connection Ø 130 mm, CP 6206.380, 6212.380
- Tilting adaptor 10° CP 60/120 for support arm connection Ø 130 mm, 6206.400
- Tilting adaptor +/-45° CP 60/120 for support arm connection Ø 130 mm, 6206.420
- Coupling CP 180 for support arm connection Ø 130 mm, 6218.300

Material:

- Connection plate: Cast aluminium
- Reinforcement plate: Sheet steel, 6 mm

Colour:

- RAL 7035

Supply includes:

- Connection plates
- Reinforcement plate
- Seals
- Assembly parts

Support arm system CP 40/60/120/180

Tilting adaptor +/-45°

for command panels with support arm connection Ø 130 mm

For mounting between:

- Coupling CP 60, 6206.300
- Coupling CP 120, 6212.300
- Coupling CP 180, 6218.300

or

- Attachment CP 60, 6206.320
- Attachment CP 120, 6212.320

or

- Angle coupling 90°, CP 60, 6206.380
- Angle coupling 90°, CP 120, 6212.380

and the command panel

Tilt angle:

- Adjustable in 7.5° increments

Material:

- Tilting adaptor: Cast aluminium
- Concertina section: Plastic

Colour:

- RAL 7024

Supply includes:

- Tilting adaptor
- Concertina section
- Seals
- Assembly parts

Weight kg	Model No.
1.2	6206.420



Enclosures

Tilting adaptor +100°/-60°

for command panels with support arm connection □ 120 x 65 mm

For mounting on

- IW worktop, prepared for attachment of Ø 130 mm
- Surfaces
- Attachment/coupling with support arm connection □ 120 x 65 mm

To fit enclosures up to 20 kg with support arm connection

- □ 90 x 71 mm
- Ø 130 mm
- □ 120 x 65 mm
- VESA Standard 75

With cable tube for protected cable entry.

Tilt angle:

- Adjustable in 7.2° increments via clamping lever and may be limited to +100°/-15° using the stop screw supplied loose

Material:

- Tilting adaptor: Sheet steel, spray-finished
- Concertina section: Plastic

Colour:

- Tilting adaptor: RAL 7035
- Concertina section: RAL 7024

Supply includes:

- Tilting adaptor
- Concertina section
- Assembly parts

Weight kg	Model No.
0.8	6206.460



Support arm system CP 40/60/120/180



Tilt coupler

for support arm system CP 60

For mounting two enclosures on a support arm/stand system.

Benefits:

- Ergonomic adjustment of the screen and keyboard enclosure
- Simple, linear adjustment of the required position via the friction brake

Material:

- Cast aluminium

Surface finish:

- Textured paint

Colour:

- Tilt coupler: RAL 7035
- Covers: RAL 7024

Protection category IP to IEC 60 529:

- IP 54

Supply includes:

- Tilt coupler
- Seals
- Assembly parts

Packs of	Model No.
1 pc(s).	6206.350

Accessories:

- Adaptor CP 60 to □ 120 x 65 mm, see page 210



Adaptor for tilt coupler

CP 60 to support arm connection

□ 120 x 65 mm

Material:

- Cast aluminium

Colour:

- RAL 7035

Packs of	Model No.
1 pc(s).	6206.550



Pivot

with/without jib

For direct, vertically hinged integration into machines and systems.

Applications:

- Enclosure suspended or top-mounted

Benefits:

- With integral rotation range restrictor

Installation options:

- To fit enclosures with support arm connection Ø 130 mm.

Load capacity:

- 700 N

Rotation range/swivel area:

- Approx. 310°
- The range of rotation can be limited by inserting the grub screws provided.

Protection category IP to IEC 60 529:

- IP 54

Jib length mm	Colour	Packs of	Model No.
200	RAL 7024/7035	1 pc(s).	6206.850
-	RAL 7035	1 pc(s).	6206.870



Comfort Panel Page 172 **Optipanel** Page 174 **Compact Panel** Page 181 **Operating housings AX with handle strips** Page 178

- Pedestal, modular, consisting of:
- Pedestal base plate/cross member
 - Support section
 - Enclosure connection

Colour:
- RAL 7035

Photo shows a configuration example with equipment not included in the scope of supply

Pedestal, modular

Weight load kg			15	18	35 ¹⁾	35 ¹⁾	Page
[1] Pedestal base plate		Model No.					
Pedestal base plate/cross member			6146.100	6106.100	6106.200	6106.400	
Dimensions mm	Width		400	400	490	600	
	Height		10	108	100	205	
	Depth		400	400	600	650	
[2] Support section		Model No.					
Height-adjustable (adjustment range 732 – 1122 mm)			6146.200	-	-	-	
Closed, length 1000 mm			-	6206.100	6206.100 ¹⁾	6206.100 ¹⁾	
[3] Enclosure connection		Model No.					
Enclosure reinforcement, rigid			-	6106.110	-	-	
Attachment CP 40, steel, for support arm connection □ 90 x 71 mm			6501.070	-	-	-	
Coupling CP 40, steel, for support arm connection □ 90 x 71 mm			6501.050	-	-	-	
Coupling CP 40, steel, for support arm connection □ 120 x 65 mm			6501.130	-	-	-	
Attachment CP 60, for support arm connection Ø 130 mm			-	-	6206.320	6206.320	
Attachment CP 60, for support arm connection □ 120 x 65 mm			-	-	6206.360	6206.360	
Coupling CP 60, for support arm connection Ø 130 mm			-	-	6206.300	-	
Coupling CP 60, for support arm connection □ 120 x 65 mm			-	-	6206.340	-	
Tilt adjustment			6146.300	-	-	-	
Accessories							
Adaptor CP 60 to CP 40			-	6206.650	6206.650	6206.650	214
Twin castors			6148.000	-	6148.000	■	893
Levelling feet			-	-	4612.000	-	892
Base mounting bracket			-	-	6147.000	-	214

¹⁾ Alternative: Support arm system CP 120 may also be used by simply drilling a hole, weight load 50 kg

Stand systems



Comfort Panel Page 172 Optipanel Page 174 Compact Panel Page 181 Operating housings AX with handle strips Page 178

The right system to suit any application:

- Different design variants
- Weight load from 15 – 25 kg
- Reliable protection of cable management

Colour:
- RAL 7035

Photo shows a configuration example with equipment not included in the scope of supply

Pedestal, complete

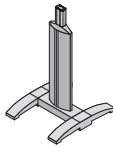
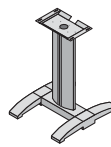
			
Weight load kg	25	25	Page
Model No.	6106.300	6141.200	
Width mm	600	600	
Height mm	1093	946	
Depth mm	660	660	
Supply includes			
Cross member	■	■	
Base plate	-	-	
Support section	■	-	
Vertical aluminium panel	■	■	
Worktop attachment	-	■	
Accessories			
Adaptor CP 60 to CP 40	6206.650	-	214
Twin castors	6148.000, 7495.000	6148.000, 7495.000	893
Levelling feet	4612.000	4612.000	892
Base mounting bracket	6147.000	6147.000	214
Attachment CP 60, for support arm connection Ø 130 mm	6206.320	-	195
Attachment CP 60, for support arm connection □ 120 x 65 mm	6206.360	-	195
Coupling CP 60, for support arm connection Ø 130 mm	6206.300	-	195
Coupling CP 60, for support arm connection □ 120 x 65 mm	6206.340	-	195
Worktop without handle ¹⁾	-	6902.310	

¹⁾ W x H x D 950 x 38 x 600 mm



Comfort Panel Page 172 **Optipanel** Page 174 **Compact Panel** Page 181 **Operating housings AX with handle strips** Page 178

The welded alternatives to the pedestal, complete

- Open pedestal for retrospective cable entry with pre-assembled connectors
- Pillar, small: For heavy installed equipment

Material:
- Steel

Surface finish:
- Spray-finished

Colour:
- RAL 7035

Photo shows a configuration example with equipment not included in the scope of supply

Pedestal, open/pillar, small

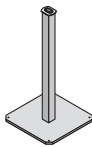
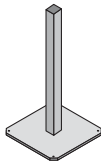
			
Weight load kg	40	80	Page
	6106.500	6112.500	
Supply includes			
Base plate cross section mm	Width	380	500
	Height	10	12
	Depth	380	500
Overall height mm	1095	1150	
Accessories			
Attachment CP 60, for support arm connection Ø 130 mm	6206.320	-	195
Attachment CP 60, for support arm connection □ 120 x 65 mm	6206.360	-	195
Coupling CP 60, for support arm connection Ø 130 mm	6206.300	-	195
Coupling CP 60, for support arm connection □ 120 x 65 mm	6206.340	-	195
Attachment CP 120, for support arm connection Ø 130 mm	-	6212.320	199
Coupling CP 120, for support arm connection Ø 130 mm	-	6212.300	199
Adaptor CP 60 to CP 40	6206.650	-	214

Stand systems

Accessories



Base mounting bracket

Brackets for screw-fastening from below to the pedestals with posidrive raised countersunk screws M12. Optionally with projection at the front, interior or sides, with Ø 11 mm hole for screw-fastening to the base.

Material:

- Steel

Surface finish:

- Zinc-plated

Supply includes:

- Posidrive raised countersunk screws M12

Packs of	Model No.
4 pc(s).	6147.000



1

Enclosure reinforcement

For external or internal reinforcement of enclosures of a corresponding size. Smaller enclosures may also be mounted directly without reinforcement.

Supply includes:

- Assembly parts for the enclosure and support section plus 2 seals



2

	For enclosure	Support arm connection	Material	Weight kg	Model No.
1	B1 ≥ 300 mm, T1 ≥ 150 mm	CP 40, stainless steel	Stainless steel 1.4301	0.9	6143.310
2	B1 ≥ 300 mm, T1 ≥ 150 mm	CP 60	Sheet steel	0.9	6106.110



Adaptor CP 60 to CP 40

for stand and support arm systems

For the transition from support section CP 60 to 48 round pipe.

Material:

- Steel

Colour:

- RAL 7035

Supply includes:

- Adaptor
- Self-tapping screws for support section attachment
- Seal

Length mm	Weight kg	Rigid	Packs of	Model No.
300	1.81	■	1 pc(s).	6206.650

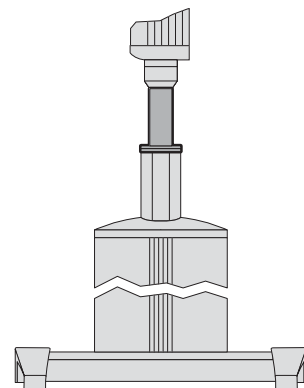

Comfort Panel

Simple selection with the online configurator,
see page 273



Configure online at
www.rittal.com/configurators

Rittal – The System.

Faster – better – everywhere.



Hygienic Design

Small and compact enclosures HD

Product advantages	218
Terminal boxes HD	220
Compact enclosures HD, single-door	221
Compact enclosures HD, two-door	222
Accessories	223

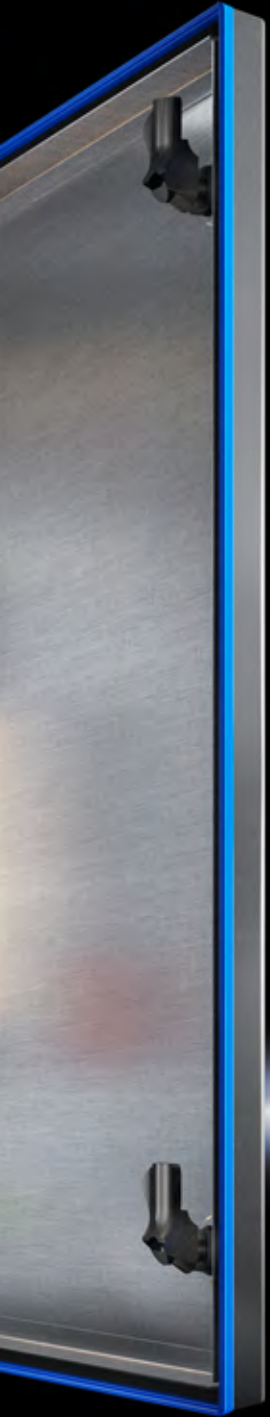

Hygienic Design enclosures – Added cleanliness guaranteed!



Silicone seal

- All-round external joint-free silicone seal
- Easy to replace
- Guides and fixes the lid to the screw fasteners
- All-round tilt for terminal boxes
 - Enclosure: 3°
 - Lid: 10°

Interior installation

- Mounting hole pitch pattern of 6.25 mm for greater flexibility
- KX support rails and mounting plates may be directly fitted

Hinges and seal

- Hinges that are inside the sealing zone create an exceptionally easy-clean design on the outside
- The durable all-round, external silicone seal is joint-free
- Installed sealing frames are easily replaced
- No external cavity between enclosure and door
- Seal dyed blue to clearly distinguish it from foodstuffs

Screw fastener

- Captive
- With external seal
- Hexagon shape for perfect cleanliness

Lock and lock insert

- External parts made of stainless steel
- Material and shape allow easy and reliable cleaning

Roof, tilted

- 30° tilt on compact enclosures prevents objects from being deposited on it
- Easily inspected
- Allows fluids to drain off rapidly



Hygienic Design

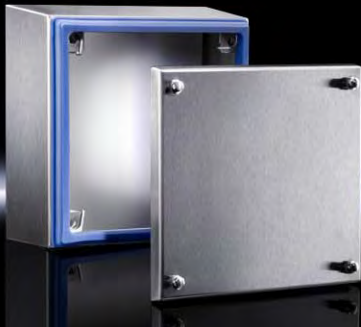

HD accessories Page 223 System accessories Page 877 Terminal boxes KX, stainless steel Page 230

Design:

- Enclosure angled forwards by 3°

Material:

- Enclosure and cover: Stainless steel 1.4301 (AISI 304) 1.5 mm
- Mounting bracket: Sheet steel, zinc-plated, passivated, 2.0 mm
- Screw plug: Stainless steel
- Seal: Silicone, compliant with FDA Guideline 21 CFR 177.2600

Surface finish:

- Enclosure and cover: Brushed, grain 400, peak-to-valley height < 0.8 µm
- Seal: Blue, dyed (RAL 5010)

Protection category IP to IEC 60 529:

- IP 66
- IP X9

Protection category NEMA:

- NEMA 13
- NEMA 3R
- NEMA 4X

Supply includes:

- Enclosure of all-round solid construction
- Cover
- Mounting bracket (pre-assembled)
- Seal and screw plug (supplied loose)

Approvals:

- UL
- cUL

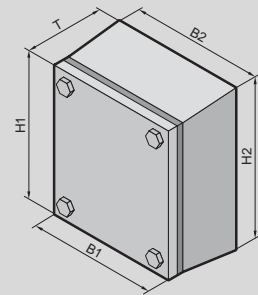

Terminal boxes HD

Width front (B1) mm	Packs of	150	150	200	300	400	400	Page
Width rear (B2) mm		172	177	227	327	427	427	
Height front (H1) mm		150	150	200	200	200	300	
Height rear (H2) mm		172	177	227	227	227	327	
Depth (T) mm		80	120	120	120	120	120	
Model No.	1 pc(s).	1670.600	1671.600	1672.600	1674.600	1675.600	1676.600	
Weight kg		1.7	2.2	3.0	4.0	5.0	5.9	

Accessories

Wall spacer bracket HD	1 pc(s).	4000.100	4000.100	4000.100	4000.100	4000.100	4000.100	223
Support rail TS 35/7.5	10 pc(s).	2314.000	2314.000	2315.000	2316.000	2317.000	2317.000	997
Cable gland HD		see page	see page	see page	see page	see page	see page	1057
Mounting plate	1 pc(s).	1560.800	1560.800	1562.800	1563.800	1564.800	1568.800	970



HD accessories Page 223 System accessories Page 877 AX stainless steel Page 236

Design:

- Roof angled forwards by 30°

Material:

- Enclosure and door: Stainless steel 1.4301 (AISI 304)
- Mounting plate: Sheet steel
- Lock insert HD: Stainless steel 1.4404 (AISI 316L)
- Seal: Silicone, compliant with FDA Guideline 21 CFR 177.2600

Surface finish:

- Enclosure and door: Brushed, grain 400, peak-to-valley height < 0.8 µm
- Mounting plate: Zinc-plated
- Seal: Blue, dyed (RAL 5010)

Protection category IP to IEC 60 529:

- IP 66
- IP X9

Protection category NEMA:

- NEMA 13
- NEMA 4X

Supply includes:

- Enclosure of all-round solid construction
- Door with inserted seal
- Door hinged on the right, may be swapped to the left
- Mounting plate

Approvals:

- UL
- cUL

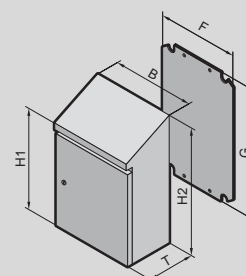

Compact enclosures HD, single-door

	Packs of	220	390	390	510	610	Page
Width (B) mm		220	390	390	510	610	
Height front (H1) mm		350	430	650	550	430	
Height rear (H2) mm		437	549	769	669	601	
Depth (T) mm		155	210	210	210	300	
Mounting plate width (F) mm		162	330	330	450	550	
Mounting plate height (G) mm		275	355	575	475	355	
Model No.	1 pc(s).	1302.600	1306.600	1308.600	1307.600	1320.600	
Weight kg		6.6	14.7	17.9	19.7	21.7	

Accessories

Wall spacer bracket HD	1 pc(s).	4000.100	4000.100	4000.100	4000.100	4000.100	223
Cable gland HD		see page	see page	see page	see page	see page	1057
Rail for interior installation	4 pc(s).	–	–	5001.050	–	–	225
T handle HD	1 pc(s).	4000.065	4000.065	4000.065	4000.065	4000.065	223

Compact enclosures HD, single-door

	Packs of	610	810	810	810	810	Page
Width (B) mm		610	810	810	810	810	
Height front (H1) mm		650	430	650	1050	1250	
Height rear (H2) mm		769	549	821	1221	1421	
Depth (T) mm		210	210	300	300	300	
Mounting plate width (F) mm		550	750	750	745	745	
Mounting plate height (G) mm		575	355	575	975	1145	
Model No.	1 pc(s).	1310.600	1314.600	1315.600	1316.600	1317.600	
Weight kg		27.4	25.5	39.0	60.1	71.0	

Accessories

Wall spacer bracket HD	1 pc(s).	4000.100	4000.100	4000.100	4000.100	4000.100	223
Cable gland HD		see page	see page	see page	see page	see page	1057
Rail for interior installation	4 pc(s).	5001.050	–	5001.050	see page	see page	225
T handle HD	1 pc(s).	4000.065	4000.065	4000.065	4000.065	4000.065	223

Hygienic Design



HD accessories Page 223 System accessories Page 877 AX stainless steel Page 236

Design:

- Roof angled forwards by 30°

Material:

- Enclosure and doors: Stainless steel 1.4301 (AISI 304)
- Mounting plate: Sheet steel
- Lock insert HD: Stainless steel 1.4404 (AISI 316L)
- Seal: Silicone, compliant with FDA Guideline 21 CFR 177.2600

Surface finish:

- Enclosure and door: Brushed, grain 400, peak-to-valley height < 0.8 µm
- Mounting plate: Zinc-plated
- Seal: Blue, dyed (RAL 5010)

Protection category IP to IEC 60 529:

- IP 66
- IP X9

Protection category NEMA:

- NEMA 13
- NEMA 4X

Supply includes:

- Enclosure of all-round solid construction
- Door with inserted seal
- Mounting plate

Approvals:

- UL
- cUL

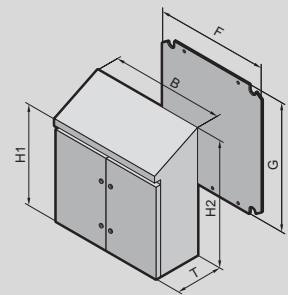

Compact enclosures HD, two-door

Width (B) mm	Packs of	1010	1010	Page
Height front (H1) mm		1050	1250	
Height rear (H2) mm		1280	1480	
Depth (T) mm		400	400	
Mounting plate width (F) mm		945	945	
Mounting plate height (G) mm		975	1175	
Model No.	1 pc(s).	1318.600	1319.600	
Accessories				
Wall spacer bracket HD	1 pc(s).	4000.100	4000.100	223
Cable gland HD		see page	see page	1057
Rail for interior installation	4 pc(s).	5001.052	5001.053	225
T handle HD	1 pc(s).	4000.065	4000.065	223

Hygienic Design

Accessories

Levelling feet HD

Benefits:

- Minimises cleaning time thanks to fully covered, permanently sealed threads
- Compensation of floor inclines up to an angle of 10° thanks to flexible base
- Baying can even be achieved on sloping floors, thanks to a large levelling range

Material:

- Stainless steel 1.4301 (AISI 304)

Load capacity:

- Max. 7000 N static per levelling foot

Supply includes:

- Assembly parts and seals

Design	Thread	Adjustment range mm	Packs of	Model No.
without base mount	M12	122 - 175	4 pc(s).	4000.240
with base attachment	M12	122 - 175	4 pc(s).	4000.250



Wall spacer bracket HD

Benefits:

- Creates space for cleaning behind the enclosure
- Shorter assembly times by eliminating the need for an all-round seal
- Improved hygiene by avoiding inaccessible dead spaces or gaps between the enclosure and wall

Functions:

- Mounting on the wall optionally from the enclosure interior via a through-hole (max. M8) or from the rear via an integral M10 thread

Material:

- Stainless steel 1.4301 (AISI 304)

Supply includes:

- Assembly parts and seals

Note:

- Depending on the size of the enclosure, up to 4 wall spacer brackets are required to ensure sufficiently stable wall mounting

Wall distance mm	Packs of	Model No.
50	1 pc(s).	4000.100

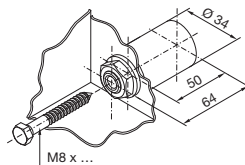

Attachment from inside

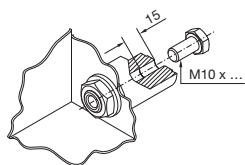

Attachment from outside

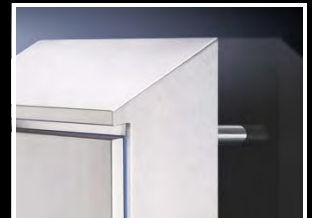

T handle HD

For easy opening without a key. May be exchanged in all enclosures with cam lock.

Material:

- Stainless steel 1.4301 (AISI 304)

Packs of	Model No.
1 pc(s).	4000.065



Hygienic Design

Accessories



Cam lock HD

Hygienic Design variant for easy, safe cleaning.

Applications:

- May be integrated into customised applications, e.g. covers of machine panels.

Material:

- Stainless steel 1.4404 (AISI 316L)
- Fastener lug, lock nut: Steel, zinc-plated

Packs of	Model No.
1 pc(s).	2304.010

+ **Accessories:**

- Enclosure key HD, see page 224



Enclosure key HD

For HD cam lock.

Note:

- Enclosure, case and lock systems are supplied as standard with matching keys

Packs of	Model No.
1 pc(s).	2549.600



Bit HD for universal key 2549.500

Packs of	Model No.
1 pc(s).	2549.510

Hygienic Design

Accessories

Rails for interior installation

for HD compact enclosures

For mounting on the existing threaded bolts.
With system punchings on three sides.

Material:

– Sheet steel, zinc-plated

Supply includes:

– Assembly parts

Length mm	Packs of	Model No.	Page
510	4 pc(s).	5001.050	995
710	4 pc(s).	5001.051	995
910	4 pc(s).	5001.052	995
1110	4 pc(s).	5001.053	995

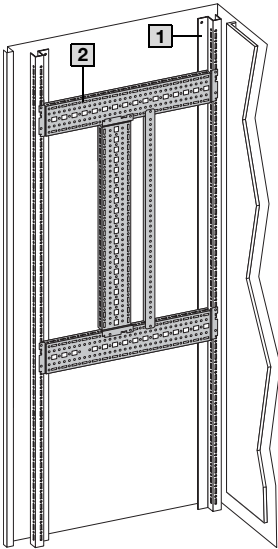

Interior installation, door

Enclosure	1	1	1
Model No.	Model No.		
1316.600	5001.052	5001.050	5001.050
1317.600	5001.053	5001.051 5001.050	5001.051 5001.050
1318.600	5001.052	5001.050	5001.050
1319.600	5001.053	5001.051 5001.050	5001.051 5001.050

Interior installation, enclosure

Enclosure	1	2	3
	Rails for interior installation 	Punched section with mounting flange, 17 x 73 mm 	Mounting plates
Model No.	Model No.		
1308.600 1310.600 1315.600	5001.050	–	–
1316.600	5001.052	8612.130 (only on lock side)	8612.400 8612.410
1317.600	5001.053	8612.130 (only on lock side)	8612.400 8612.410
1318.600	5001.052	–	8612.400 8612.410
1319.600	5001.053	–	8612.400 8612.410

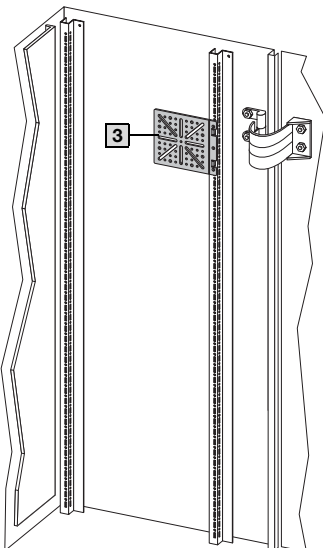

Rittal – The System.

Faster – better – everywhere.



Stainless steel



Small enclosures KX

Terminal boxes KX.....	230
E-Box KX.....	232
Bus enclosures KX	234

Small enclosures

Switch housings	235
-----------------------	-----



Compact enclosures AX

Compact enclosures AX, basic enclosure	236
--	-----

Enclosure systems



Baying enclosure system VX25, basic enclosure.....	242
Baying enclosure system VX25, IP 66/NEMA 4X.....	246

Free-standing enclosure system VX SE, basic enclosure	248
Free-standing enclosure system VX SE, IP 66/NEMA 4X	250

Console systems/PC enclosure systems

One-piece console	251
PC enclosure system.....	252

Command panels

Premium Panel	253
Command panel housing with door	254

Support arm system

Support arm system CP 40	188
--------------------------------	-----



Stainless steel enclosures

The secure choice for harsh environments



Incredible enclosure diversity

- Stainless steel enclosures for all requirement profiles in modern industrial technology. They meet the extremely high demands associated with corrosion protection and chemical substances.
- The smooth surface boasts outstanding hygienic properties which means less cleaning work.
- Depending on the requirements, the materials used are stainless steel 1.4301 (AISI 304) or stainless steel 1.4404 (AISI 316L).
- Cleverly thought-out system platforms, in conjunction with an extensive selection of system accessories, create outstanding solution diversity in the Rittal stainless steel range.

Coordinating accessories

- The uniform system platforms used in the sheet steel range produce unique installation diversity with identical engineering.
- In particular, the interior installation largely eliminates any machining of the enclosures and therefore plays a key role in maintaining the high protection category.

Optimum climate control

- Among stainless steel applications, climate control often represents a major problem because the risk of expensive system failures or machine standstills can only be decisively reduced with the right climate control components. Rely on Rittal for the perfect solutions:
 - An extensive range of wall- and roof-mounted cooling units with efficient Blue e+ technology
 - Fan-and-filter units combined with a hose-proof hood provide a simple, efficient and secure solution provided the ambient temperature is sufficiently low
 - With one of the world's leading ranges and a comprehensive service portfolio, Rittal offers individual solution concepts to minimise the risks

Efficient engineering

- Uniform design basis for sheet steel and stainless steel racks and enclosures for simple, fast assembly
- Identical engineering for sheet steel and stainless steel allows simple, time-saving planning
- A host of tools provide support with the automated production process and when working with virtual prototypes:
 - Rittal Configuration System
 - EPLAN Pro Panel
 - 2D/3D CAD data
 - ecl@ss Advanced
 - Technical documentation
- Fast, efficient calculation of climate control requirements for individual enclosure assemblies with Therm software



Small enclosures KX



System accessories Page 877 **Terminal boxes KX, sheet steel** Page 56 **Ex enclosures** Page 257 **Hygienic Design** Page 217

Material:

- Enclosures: Stainless steel 1.4301 (AISI 304)
- Cover: Stainless steel 1.4301 (AISI 304), all-round foamed-in PU seal

Surface finish:

- Enclosure and cover: Brushed, grain size 400

Protection category IP to IEC 60 529:

- IP 66

Protection category NEMA:

- NEMA 4X

Supply includes:

- Enclosure with cover
- Mini cam locks

Approvals:

- UL
 - cUL
- Further approvals can be found on the Internet.

Terminal boxes KX, stainless steel, without gland plate

Width mm	Packs of	150	150	300	200	200	Page
Height mm		150	150	150	200	200	
Depth mm		80	120	80	80	120	
Material thickness – enclosure mm		1.25	1.25	1.25	1.25	1.25	
Material thickness – cover mm		1.25	1.25	1.25	1.25	1.25	
Model No.	1 pc(s).	1560.000	1564.000	1561.000	1562.000	1565.000	
Weight, approx. kg		1.3	1.6	1.8	1.8	2.2	
Mini cam lock		4	4	4	4	4	

Accessories

Wall mounting bracket, for AX stainless steel, KX stainless steel	4 pc(s).	1594.010	1594.010	1594.010	1594.010	1594.010	965
Wall angle	4 pc(s).	–	–	2583.010	2583.010	2583.010	967
Pole clamp	2 pc(s).	2584.100	2584.100	2584.100	2584.100	2584.100	968
Mounting plates	1 pc(s).	1560.800	1560.800	1561.800	1562.800	1562.800	970
Support rails TS 35/7.5	10 pc(s).	2314.000	2314.000	2316.000	2315.000	2315.000	997
Mounting clip for support rails	30 pc(s).	2309.000	2309.000	2309.000	2309.000	2309.000	997
Mounting bracket	4 pc(s).	4597.000	4597.000	4597.000	4597.000	4597.000	999
Rail mounting bracket	20 pc(s).	2365.000	2366.000	2365.000	2365.000	2366.000	1002
Mounting claw for second mounting level	20 pc(s).	2309.100	2309.100	2309.100	2309.100	2309.100	998
Cover hinge, stainless steel	2 pc(s).	1592.210	1592.210	1592.210	1592.210	1592.210	951
Earth straps	5 pc(s).	2565.100	2565.050	2565.100	2565.100	2565.050	1033
Baying kit	1 pc(s).	–	1199.100	–	–	1199.100	916
Pressure relief stopper	5 pc(s).	2459.500	2459.500	2459.500	2459.500	2459.500	900
Condensate discharge	6 pc(s).	2459.000	2459.000	2459.000	2459.000	2459.000	900
Self-tapping screws for mounting plate	300 pc(s).	2487.000	2487.000	2487.000	2487.000	2487.000	1004

Terminal boxes KX, stainless steel, without gland plate

Width mm	Packs of	300	300	400	300	400	Page
Height mm		200	200	200	300	300	
Depth mm		80	120	120	120	120	
Material thickness – enclosure mm		1.25	1.25	1.25	1.25	1.25	
Material thickness – cover mm		1.25	1.25	1.25	1.25	1.25	
Model No.	1 pc(s).	1563.000	1566.000	1568.000	1567.000	1569.000	
Weight, approx. kg		2.4	2.9	3.6	3.9	4.6	
Mini cam lock		4	4	4	4	4	
Accessories							
Wall mounting bracket, for AX stainless steel, KX stainless steel	4 pc(s).	1594.010	1594.010	1594.010	1594.010	1594.010	965
Wall angle	4 pc(s).	2583.010	2583.010	2583.010	2583.010	2583.010	967
Pole clamp	2 pc(s).	2584.100	2584.100	2584.100	2584.100	2584.100	968
Mounting plates	1 pc(s).	1563.800	1563.800	1564.800	1567.800	1568.800	970
Support rails TS 35/7.5	10 pc(s).	2316.000	2316.000	2317.000	2316.000	2317.000	997
Mounting clip for support rails	30 pc(s).	2309.000	2309.000	2309.000	2309.000	2309.000	997
Mounting bracket	4 pc(s).	4597.000	4597.000	4597.000	4597.000	4597.000	999
Rail mounting bracket	20 pc(s).	2365.000	2366.000	2366.000	2366.000	2366.000	1002
Mounting claw for second mounting level	20 pc(s).	2309.100	2309.100	2309.100	2309.100	2309.100	998
Cover hinge, stainless steel	2 pc(s).	1592.210	1592.210	1592.210	1592.210	1592.210	951
Earth straps	5 pc(s).	2565.100	2565.050	2565.050	2565.050	2565.050	1033
Baying kit	1 pc(s).	–	1199.100	1199.100	1199.100	1199.100	916
Pressure relief stopper	5 pc(s).	2459.500	2459.500	2459.500	2459.500	2459.500	900
Condensate discharge	6 pc(s).	2459.000	2459.000	2459.000	2459.000	2459.000	900
Self-tapping screws for mounting plate	300 pc(s).	2487.000	2487.000	2487.000	2487.000	2487.000	1004

Small enclosures KX



System accessories Page 877 E-Box KX, sheet steel Page 64 Ex enclosures Page 257

Material:

- Enclosure: Stainless steel
- Door: Stainless steel, all-round foamed-in PU seal
- Mounting plate: Sheet steel

Surface finish:

- Enclosure and door: Brushed, grain size 400
- Mounting plate: Zinc-plated

Protection category IP to IEC 60 529:

- IP 66

Protection category NEMA:

- NEMA 4X

Supply includes:

- Enclosure with door
- Mounting plate
- Cam lock with 3 mm double-bit insert

Approvals:

- UL
- cUL

Further approvals can be found on the Internet.

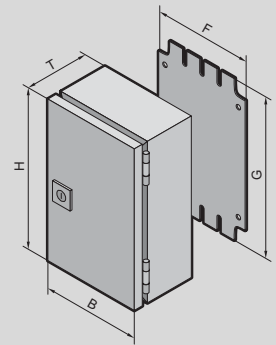

E-Box KX, stainless steel, depth 120/155 mm

Width (B) mm	Packs of	200	200	200	380	Page
Height (H) mm		300	300	300	300	
Depth (T) mm		120	155	155	155	
Mounting plate width (F) mm		175	175	175	365	
Mounting plate height (G) mm		285	285	285	275	
Material	Stainless steel 1.4301 (AISI 304)	■	■	–	■	
	Stainless steel 1.4404 (AISI 316L)	–	–	■	–	
Material thickness – enclosure mm		1.25	1.25	1.5	1.25	
Material thickness – door mm		1.25	1.25	1.5	1.25	
Model No.	1 pc(s).	1584.000	1587.000	1301.000	1588.000	
Weight, approx. kg		3.6	4.1	4.1	7.5	

Accessories						
Wall mounting bracket, for AX stainless steel, KX stainless steel	4 pc(s).	1594.010	1594.010	1594.010	1594.010	965
Pole clamp	2 pc(s).	2584.100	2584.100	2584.100	2584.100	968
Support rails TS 35/7.5	10 pc(s).	2315.000	2315.000	2315.000	2317.000 ¹⁾	997
Mounting clip for support rails	30 pc(s).	2309.000	2309.000	2309.000	2309.000	997
Mounting bracket	4 pc(s).	4597.000	4597.000	4597.000	4597.000	999
Rail mounting bracket	20 pc(s).	2366.000	2366.000	2366.000	2366.000	1002
Mini-comfort handle AX for lock inserts or profile half-cylinders	1 pc(s).	2537.100	2537.100	2537.100	2537.100	940
Mini-comfort handle AX for padlocks and lock inserts or profile half-cylinders	1 pc(s).	2537.300	2537.300	2537.300	2537.300	940
Cam lock with double-bit insert, stainless steel 1.4404 (AISI 316L)	1 pc(s).	2309.110	2309.110	2309.110	2309.110	943
Lock insert 7 mm square	1 pc(s).	2460.000	2460.000	2460.000	2460.000	941
Lock insert 8 mm square	1 pc(s).	2461.000	2461.000	2461.000	2461.000	941
Lock insert 7 mm triangular	1 pc(s).	2462.000	2462.000	2462.000	2462.000	941
Lock insert 8 mm triangular	1 pc(s).	2463.000	2463.000	2463.000	2463.000	941
Lock insert, screwdriver	1 pc(s).	2464.000	2464.000	2464.000	2464.000	941
Lock insert Daimler	1 pc(s).	2465.000	2465.000	2465.000	2465.000	941
Lock insert 3 mm double-bit	1 pc(s).	2466.000	2466.000	2466.000	2466.000	941
Lock insert Fiat	1 pc(s).	2307.000	2307.000	2307.000	2307.000	941
Lock insert 6.5 mm triangular	1 pc(s).	2460.650	2460.650	2460.650	2460.650	941
Earth straps	5 pc(s).	2565.050	2565.050	2565.050	2565.050	1033
Pressure relief stopper	5 pc(s).	2459.500	2459.500	2459.500	2459.500	900
Condensate discharge	6 pc(s).	2459.000	2459.000	2459.000	2459.000	900
Self-tapping screws for mounting plate	300 pc(s).	2487.000	2487.000	2487.000	2487.000	1004

¹⁾ Must be cut to length accordingly

Rittal – The System.



Rittal Configuration System

see page 272

Small enclosures KX



System accessories Page 877 **Bus enclosures KX, sheet steel** Page 70

Material:

- Enclosures: Stainless steel 1.4301 (AISI 304)
- Cover: Stainless steel 1.4301 (AISI 304), all-round foamed-in PU seal
- Hinges: Die-cast zinc

Surface finish:

- Enclosure and cover: Brushed, grain size 400

Protection category IP to IEC 60 529:

- IP 66

Protection category NEMA:

- NEMA 4X

Supply includes:

- Enclosure with hinged cover
- Mini cam lock

Approvals:

- UL
 - cUL
- Further approvals can be found on the Internet.

Bus enclosures KX, stainless steel

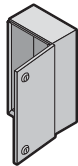
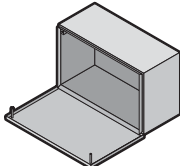
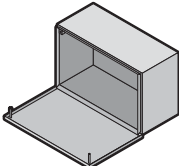
					
Width mm	Packs of	200	400	600	Page
Height mm		300	200	200	
Depth mm		80	120	120	
Material thickness – enclosure mm		1.25	1.25	1.25	
Material thickness – cover mm		1.25	1.25	1.25	
Model No.	1 pc(s).	1583.000	1585.000	1586.000	
Weight, approx. kg		2.8	4.5	6.0	
Accessories					
Wall mounting bracket, for AX stainless steel, KX stainless steel	4 pc(s).	1594.010	1594.010	1594.010	965
Wall angle	4 pc(s).	–	–	2583.010	967
Pole clamp	2 pc(s).	2584.100	2584.100	2584.100	968
Mounting plates	1 pc(s).	1563.800	1564.800	1566.800	970
Support rails TS 35/7.5	10 pc(s).	2315.000	2317.000	–	997
Support rails TS 35/15	10 pc(s).	–	–	2319.000	997
Mounting clip for support rails	30 pc(s).	2309.000	2309.000	2309.000	997
Mounting bracket	4 pc(s).	4597.000	4597.000	4597.000	999
Rail mounting bracket	20 pc(s).	2365.000	2366.000	2366.000	1002
Mounting claw for second mounting level	20 pc(s).	2309.100	2309.100	2309.100	998
Earth straps	5 pc(s).	2565.100	2565.050	2565.050	1033
Baying kit	1 pc(s).	1199.100	1199.100	1199.100	916
Pressure relief stopper	5 pc(s).	2459.500	2459.500	2459.500	900
Condensate discharge	6 pc(s).	2459.000	2459.000	2459.000	900
Self-tapping screws for mounting plate	300 pc(s).	2487.000	2487.000	2487.000	1004



System accessories Page 877

Material:

- Enclosure: Stainless steel 1.4301 (AISI 304)
- Cover: Stainless steel 1.4301 (AISI 304), all-round foamed-in PU seal

Surface finish:

- Enclosure and cover: Brushed, grain 240

Protection category IP to IEC 60 529:

- IP 66

Protection category NEMA:

- NEMA 4X

Supply includes:

- Enclosure with cover
- Quick-release fastener including plastic bushes

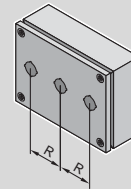

Switch housings, stainless steel

Width mm	Packs of	100	160	220	280	Page
Height mm		100	100	100	100	
Depth mm		90	90	90	90	
Material thickness - enclosure mm		1.25	1.25	1.25	1.25	
Material thickness - cover mm		1.25	1.25	1.25	1.25	
Model No.	1 pc(s).	2384.010	2384.020	2384.030	2384.040	
Pitch pattern (R) mm		-	60	60	60	
No. of switch cut-outs Ø 22.5 mm		1	2	3	4	
Number of locks		2	4	4	4	
Accessories						
Wall mounting bracket	4 pc(s).	1594.010	1594.010	1594.010	1594.010	965
Pressure relief stoppers	5 pc(s).	2459.500	2459.500	2459.500	2459.500	900
Cable gland HD		see page	see page	see page	see page	1057
Earth straps	5 pc(s).	2565.100	2565.100	2565.100	2565.100	1033

Compact enclosures AX



System accessories Page 877 AX sheet steel Page 84 Ex enclosures Page 257 Hygienic Design Page 217 Outdoor housing Page 958

Material:

- Enclosure: Stainless steel
- Door: Stainless steel, all-round foamed-in PU seal
- Mounting plate: Sheet steel
- Lock: Die-cast zinc, nickel-plated, double-bit insert: Stainless steel

Surface finish:

- Enclosure and door: Brushed, grain size 400
- Mounting plate: Zinc-plated

Supply includes:

- Enclosure with door(s)
 - Mounting plate
 - Lock: 3 mm double-bit
- Please note the product-specific scope of supply.

Approvals:

- UL
 - cUL
- Further approvals can be found on the Internet.

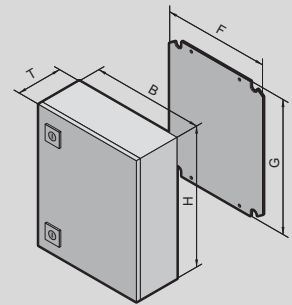

Basic enclosure AX, stainless steel

Width (B) mm	Packs of	300	300	Page
Height (H) mm		300	380	
Depth (T) mm		210	210	
Mounting plate width (F) mm		250	250	
Mounting plate height (G) mm		275	355	
Material	Stainless steel 1.4301 (AISI 304)	■	■	
	Stainless steel 1.4404 (AISI 316L)	–	–	
Model No.	1 pc(s).	1003.000	1005.000	
Weight, approx. kg		6.9	8.4	
Protection category IP to IEC 60 529		IP 66	IP 66	
Protection category NEMA		NEMA 4X	NEMA 4X	
Product-specific scope of supply				
Door(s)		1	1	
Cam lock		1	1	
3-point lock system		–	–	

Accessories				
Wall mounting bracket, for AX stainless steel, KX stainless steel, wall distance 20 mm	4 pc(s).	2433.010	2433.010	967
Wall angle, stainless steel 1.4301	4 pc(s).	2583.010	2583.010	967
Pole clamp	2 pc(s).	2584.100	2584.100	968
Rail for interior installation	4 pc(s).	2393.210	2393.210	989
Punched section with mounting flange 14 x 39 mm, installation in the height		–	–	
Punched section with mounting flange 14 x 39 mm, installation in the door		–	–	
Support strips, installation in the door		–	–	
LED system light		–	–	
Comfort handle AX for lock inserts or profile half-cylinders		–	–	
Mini-comfort handle AX for lock inserts or profile half-cylinders	1 pc(s).	2537.100	2537.100	940
Cam lock with double-bit insert, stainless steel 1.4404 (AISI 316L)	1 pc(s).	2304.100	2304.100	943
Lock inserts		see page	see page	941, 942
Perforated door strip		–	–	
Door stay	1 pc(s).	2519.010	2519.010	956
Sheet steel wiring plan pockets, width-variable		–	–	
Plastic wiring plan pockets		see page	see page	955
Wiring plan pockets with transparent pouch		see page	see page	955
Protective roof	1 pc(s).	2361.010	2361.010	958
Earth straps		see page	see page	1033
Baying kit	1 pc(s).	1199.100	1199.100	916
Cable gland, brass M12 x 1.5	15 pc(s).	2411.801	2411.801	1056
Cable gland, brass M16 x 1.5	15 pc(s).	2411.811	2411.811	1056
Cable gland, brass M20 x 1.5	10 pc(s).	2411.821	2411.821	1056
Cable gland, brass M25 x 1.5	10 pc(s).	2411.831	2411.831	1056
Cable gland, brass M32 x 1.5	5 pc(s).	2411.841	2411.841	1056
Cable gland, brass M40 x 1.5	4 pc(s).	2411.851	2411.851	1056
Cable gland, brass M50 x 1.5	2 pc(s).	2411.861	2411.861	1056
Cable gland, brass M63 x 1.5	1 pc(s).	2411.871	2411.871	1056
Cable gland, polyamide M12 x 1.5	50 pc(s).	2411.601	2411.601	1056
Cable gland, polyamide M16 x 1.5	50 pc(s).	2411.611	2411.611	1056
Cable gland, polyamide M20 x 1.5	50 pc(s).	2411.621	2411.621	1056
Cable gland, polyamide M25 x 1.5	25 pc(s).	2411.631	2411.631	1056
Cable gland, polyamide M32 x 1.5	15 pc(s).	2411.641	2411.641	1056
Cable gland, polyamide M40 x 1.5	5 pc(s).	2411.651	2411.651	1056
Cable gland, polyamide M50 x 1.5	5 pc(s).	2411.661	2411.661	1056
Cable gland, polyamide M63 x 1.5	3 pc(s).	2411.671	2411.671	1056

Compact enclosures AX

Basic enclosure AX, stainless steel

Width (B) mm	Packs of	300	380	380	380	380	400	Page
Height (H) mm		380	300	380	380	600	500	
Depth (T) mm		210	210	210	210	210	210	
Mounting plate width (F) mm		250	330	330	330	330	350	
Mounting plate height (G) mm		355	275	355	355	575	475	
Material	Stainless steel 1.4301 (AISI 304)	–	■	■	–	■	■	
	Stainless steel 1.4404 (AISI 316L)	■	–	–	■	–	–	
Model No.	1 pc(s).	1302.000	1011.000	1006.000	1303.000	1008.000	1015.000	
Weight, approx. kg		8.4	8.4	9.8	9.8	15.1	12.9	
Protection category IP to IEC 60 529		IP 66	IP 66	IP 66	IP 66	IP 66	IP 66	
Protection category NEMA		NEMA 4X	NEMA 4X	NEMA 4X	NEMA 4X	NEMA 4X	NEMA 4X	
Product-specific scope of supply								
Door(s)		1	1	1	1	1	1	
Cam lock		1	1	1	1	2	2	
3-point lock system		–	–	–	–	–	–	
Accessories								
Wall mounting bracket, for AX stainless steel, KX stainless steel, wall distance 20 mm	4 pc(s).	2433.510	2433.010	2433.010	2433.510	2433.010	2433.010	967
Wall angle, stainless steel 1.4301	4 pc(s).	2583.010	2583.010	2583.010	2583.010	2583.010	2583.010	967
Pole clamp	2 pc(s).	2584.100	2584.100	2584.100	2584.100	2584.100	2584.100	968
Rail for interior installation	4 pc(s).	2393.210	2393.210	2393.210	2393.210	2393.210	2393.210	989
Punched section with mounting flange 14 x 39 mm, installation in the height	4 pc(s).	–	–	–	–	8619.720	8619.710	990
Punched section with mounting flange 14 x 39 mm, installation in the door		–	–	–	–	–	–	
Support strips, installation in the door		–	–	–	–	–	–	
LED system light		–	–	–	–	–	2500.100	1014
Comfort handle AX for lock inserts or profile half-cylinders		–	–	–	–	–	–	
Mini-comfort handle AX for lock inserts or profile half-cylinders	1 pc(s).	2537.100	2537.100	2537.100	2537.100	2537.100	2537.100	940
Cam lock with double-bit insert, stainless steel 1.4404 (AISI 316L)	1 pc(s).	2304.100	2304.100	2304.100	2304.100	2304.100	2304.100	943
Lock inserts		see page	see page	see page	see page	see page	see page	941, 942
Perforated door strip		–	–	–	–	–	–	
Door stay	1 pc(s).	2519.010	2519.010	2519.010	2519.010	2519.010	2519.010	956
Sheet steel wiring plan pockets, width-variable		–	–	–	–	–	–	
Plastic wiring plan pockets		see page	see page	see page	see page	see page	see page	955
Wiring plan pockets with transparent pouch		see page	see page	see page	see page	see page	see page	955
Protective roof	1 pc(s).	2361.010	2472.010	2472.010	2472.010	2472.010	–	958
Earth straps		see page	see page	see page	see page	see page	see page	1033
Baying kit	1 pc(s).	1199.100	1199.100	1199.100	1199.100	1199.100	1199.100	916
Cable gland, brass M12 x 1.5	15 pc(s).	2411.801	2411.801	2411.801	2411.801	2411.801	2411.801	1056
Cable gland, brass M16 x 1.5	15 pc(s).	2411.811	2411.811	2411.811	2411.811	2411.811	2411.811	1056
Cable gland, brass M20 x 1.5	10 pc(s).	2411.821	2411.821	2411.821	2411.821	2411.821	2411.821	1056
Cable gland, brass M25 x 1.5	10 pc(s).	2411.831	2411.831	2411.831	2411.831	2411.831	2411.831	1056
Cable gland, brass M32 x 1.5	5 pc(s).	2411.841	2411.841	2411.841	2411.841	2411.841	2411.841	1056
Cable gland, brass M40 x 1.5	4 pc(s).	2411.851	2411.851	2411.851	2411.851	2411.851	2411.851	1056
Cable gland, brass M50 x 1.5	2 pc(s).	2411.861	2411.861	2411.861	2411.861	2411.861	2411.861	1056
Cable gland, brass M63 x 1.5	1 pc(s).	2411.871	2411.871	2411.871	2411.871	2411.871	2411.871	1056
Cable gland, polyamide M12 x 1.5	50 pc(s).	2411.601	2411.601	2411.601	2411.601	2411.601	2411.601	1056
Cable gland, polyamide M16 x 1.5	50 pc(s).	2411.611	2411.611	2411.611	2411.611	2411.611	2411.611	1056
Cable gland, polyamide M20 x 1.5	50 pc(s).	2411.621	2411.621	2411.621	2411.621	2411.621	2411.621	1056
Cable gland, polyamide M25 x 1.5	25 pc(s).	2411.631	2411.631	2411.631	2411.631	2411.631	2411.631	1056
Cable gland, polyamide M32 x 1.5	15 pc(s).	2411.641	2411.641	2411.641	2411.641	2411.641	2411.641	1056
Cable gland, polyamide M40 x 1.5	5 pc(s).	2411.651	2411.651	2411.651	2411.651	2411.651	2411.651	1056
Cable gland, polyamide M50 x 1.5	5 pc(s).	2411.661	2411.661	2411.661	2411.661	2411.661	2411.661	1056
Cable gland, polyamide M63 x 1.5	3 pc(s).	2411.671	2411.671	2411.671	2411.671	2411.671	2411.671	1056

Compact enclosures AX

Basic enclosure AX, stainless steel

Width (B) mm	Packs of	500	500	600	600	600	600	Page
Height (H) mm		500	500	380	600	600	760	
Depth (T) mm		210	300	210	210	210	210	
Mounting plate width (F) mm		450	450	550	550	550	550	
Mounting plate height (G) mm		475	475	355	575	575	735	
Material	Stainless steel 1.4301 (AISI 304)	■	■	■	■	–	■	
	Stainless steel 1.4404 (AISI 316L)	–	–	–	–	■	–	
Model No.	1 pc(s).	1007.000	1013.000	1009.000	1010.000	1304.000	1012.000	
Weight, approx. kg		15.7	18.4	14.6	23.5	23.5	30.2	
Protection category IP to IEC 60 529		IP 66	IP 66	IP 66	IP 66	IP 66	IP 66	
Protection category NEMA		NEMA 4X	NEMA 4X	NEMA 4X	NEMA 4X	NEMA 4X	NEMA 4X	
Product-specific scope of supply								
Door(s)		1	1	1	1	1	1	
Cam lock		2	2	1	2	2	2	
3-point lock system		–	–	–	–	–	–	
Accessories								
Wall mounting bracket, for AX stainless steel, KX stainless steel, wall distance 20 mm	4 pc(s).	2433.010	2433.010	2433.010	2433.010	2433.510	2433.010	967
Wall angle, stainless steel 1.4301	4 pc(s).	2583.010	2583.010	2583.010	2583.010	2583.010	2583.010	967
Pole clamp	2 pc(s).	2584.100	2584.100	2584.100	2584.100	2584.100	2584.100	968
Rail for interior installation	4 pc(s).	2393.210	2393.300	2393.210	2393.210	2393.210	2393.210	989
Punched section with mounting flange 14 x 39 mm, installation in the height	4 pc(s).	8619.710	8619.710	–	8619.720	8619.720	–	990
Punched section with mounting flange 14 x 39 mm, installation in the door		–	–	–	–	–	–	
Support strips, installation in the door	20 pc(s).	–	–	–	–	–	4696.000	952
LED system light	1 pc(s).	2500.100	2500.100	2500.100	2500.100	2500.100	2500.100	1014
Comfort handle AX for lock inserts or profile half-cylinders		–	–	–	–	–	–	
Mini-comfort handle AX for lock inserts or profile half-cylinders	1 pc(s).	2537.100	2537.100	2537.100	2537.100	2537.100	2537.100	940
Cam lock with double-bit insert, stainless steel 1.4404 (AISI 316L)	1 pc(s).	2304.100	2304.100	2304.100	2304.100	2304.100	2304.100	943
Lock inserts		see page	see page	see page	see page	see page	see page	941, 942
Perforated door strip	2 pc(s).	–	–	–	–	–	2311.076	953
Door stay	1 pc(s).	2519.010	2519.010	2519.010	2519.010	2519.010	2519.010	956
Sheet steel wiring plan pockets, width-variable ¹⁾	1 pc(s).	–	–	–	–	–	2515.300	954
Plastic wiring plan pockets		see page	see page	see page	see page	see page	see page	955
Wiring plan pockets with transparent pouch		see page	see page	see page	see page	see page	see page	955
Protective roof	1 pc(s).	2362.010	–	2473.010	2473.010	2473.010	2473.010	958
Earth straps		see page	see page	see page	see page	see page	see page	1033
Baying kit	1 pc(s).	1199.100	1199.100	1199.100	1199.100	1199.100	1199.100	916
Cable gland, brass M12 x 1.5	15 pc(s).	2411.801	2411.801	2411.801	2411.801	2411.801	2411.801	1056
Cable gland, brass M16 x 1.5	15 pc(s).	2411.811	2411.811	2411.811	2411.811	2411.811	2411.811	1056
Cable gland, brass M20 x 1.5	10 pc(s).	2411.821	2411.821	2411.821	2411.821	2411.821	2411.821	1056
Cable gland, brass M25 x 1.5	10 pc(s).	2411.831	2411.831	2411.831	2411.831	2411.831	2411.831	1056
Cable gland, brass M32 x 1.5	5 pc(s).	2411.841	2411.841	2411.841	2411.841	2411.841	2411.841	1056
Cable gland, brass M40 x 1.5	4 pc(s).	2411.851	2411.851	2411.851	2411.851	2411.851	2411.851	1056
Cable gland, brass M50 x 1.5	2 pc(s).	2411.861	2411.861	2411.861	2411.861	2411.861	2411.861	1056
Cable gland, brass M63 x 1.5	1 pc(s).	2411.871	2411.871	2411.871	2411.871	2411.871	2411.871	1056
Cable gland, polyamide M12 x 1.5	50 pc(s).	2411.601	2411.601	2411.601	2411.601	2411.601	2411.601	1056
Cable gland, polyamide M16 x 1.5	50 pc(s).	2411.611	2411.611	2411.611	2411.611	2411.611	2411.611	1056
Cable gland, polyamide M20 x 1.5	50 pc(s).	2411.621	2411.621	2411.621	2411.621	2411.621	2411.621	1056
Cable gland, polyamide M25 x 1.5	25 pc(s).	2411.631	2411.631	2411.631	2411.631	2411.631	2411.631	1056
Cable gland, polyamide M32 x 1.5	15 pc(s).	2411.641	2411.641	2411.641	2411.641	2411.641	2411.641	1056
Cable gland, polyamide M40 x 1.5	5 pc(s).	2411.651	2411.651	2411.651	2411.651	2411.651	2411.651	1056
Cable gland, polyamide M50 x 1.5	5 pc(s).	2411.661	2411.661	2411.661	2411.661	2411.661	2411.661	1056
Cable gland, polyamide M63 x 1.5	3 pc(s).	2411.671	2411.671	2411.671	2411.671	2411.671	2411.671	1056

¹⁾ The perforated door strip is required for the installation

Compact enclosures AX

Basic enclosure AX, stainless steel

Width (B) mm	Packs of	760	800	800	1000	1000	1000	Page
Height (H) mm		760	1000	1200	1000	1200	1200	
Depth (T) mm		300	300	300	300	300	300	
Mounting plate width (F) mm		705	745	745	945	945	945	
Mounting plate height (G) mm		735	975	1175	975	1175	1175	
Material	Stainless steel 1.4301 (AISI 304)	■	■	■	■	■	–	
	Stainless steel 1.4404 (AISI 316L)	–	–	–	–	–	■	
Model No.	1 pc(s).	1014.000	1016.000	1017.000	1018.000	1019.000	1305.000	
Weight, approx. kg		42.5	52.9	61.5	71.0	76.0	76.0	
Protection category IP to IEC 60 529		IP 66	IP 66	IP 66	IP 55	IP 55	IP 55	
Protection category NEMA		NEMA 4X	NEMA 4X	NEMA 4X	NEMA 12	NEMA 12	NEMA 12	
Product-specific scope of supply								
Door(s)		1	1	1	2	2	2	
Cam lock		2	2	–	2	–	–	
3-point lock system		–	–	■	–	■	■	

Accessories

Wall mounting bracket, for AX stainless steel, KX stainless steel, wall distance 20 mm	4 pc(s).	2433.010	2433.010	2433.010	2433.010	2433.010	2433.510	967
Wall angle, stainless steel 1.4301	4 pc(s).	2583.010	2583.010	2583.010	2583.010	2583.010	2583.010	967
Pole clamp	2 pc(s).	2584.100	2584.100	2584.100	2584.100	2584.100	2584.100	968
Rail for interior installation	4 pc(s).	2393.300	2393.300	2393.300	2393.300	2393.300	2393.300	989
Punched section with mounting flange 14 x 39 mm, installation in the height	4 pc(s).	–	8619.750	8619.770	8619.750	8619.770	8619.770	990
Punched section with mounting flange 14 x 39 mm, installation in the door	4 pc(s).	–	–	8619.730	–	8619.710	8619.710	952
Support strips, installation in the door ²⁾	20 pc(s).	4599.200	4697.000	4697.000	4695.000	4695.000	4695.000	952
LED system light	1 pc(s).	2500.110	2500.110	2500.110	2500.110	2500.110	2500.110	1014
Comfort handle AX for lock inserts or profile half-cylinders	1 pc(s).	–	–	2435.300	–	2435.300	2435.300	939
Mini-comfort handle AX for lock inserts or profile half-cylinders	1 pc(s).	2537.100	2537.100	–	2537.100	–	–	940
Cam lock with double-bit insert, stainless steel 1.4404 (AISI 316L)	1 pc(s).	2304.100	2304.100	2304.100	2304.100	–	2304.100	943
Lock inserts		see page	see page	see page	see page	see page	see page	941, 942
Perforated door strip	2 pc(s).	2311.076	2311.100	2311.120	2311.100	2311.120	2311.120	953
Door stay	1 pc(s).	2519.010	2519.010	2519.010	2519.010	2519.010	2519.010	956
Sheet steel wiring plan pockets, width-variable ¹⁾	1 pc(s).	2515.400	2515.400	2515.400	2515.200	2515.200	2515.200	954
Plastic wiring plan pockets		see page	see page	see page	see page	see page	see page	955
Wiring plan pockets with transparent pouch		see page	see page	see page	see page	see page	see page	955
Protective roof	1 pc(s).	2474.010	2475.010	2475.010	2363.010	2363.010	2363.010	958
Earth straps		see page	see page	see page	see page	see page	see page	1033
Baying kit	1 pc(s).	1199.100	1199.100	1199.100	1199.100	1199.100	1199.100	916
Cable gland, brass M12 x 1.5	15 pc(s).	2411.801	2411.801	2411.801	2411.801	2411.801	2411.801	1056
Cable gland, brass M16 x 1.5	15 pc(s).	2411.811	2411.811	2411.811	2411.811	2411.811	2411.811	1056
Cable gland, brass M20 x 1.5	10 pc(s).	2411.821	2411.821	2411.821	2411.821	2411.821	2411.821	1056
Cable gland, brass M25 x 1.5	10 pc(s).	2411.831	2411.831	2411.831	2411.831	2411.831	2411.831	1056
Cable gland, brass M32 x 1.5	5 pc(s).	2411.841	2411.841	2411.841	2411.841	2411.841	2411.841	1056
Cable gland, brass M40 x 1.5	4 pc(s).	2411.851	2411.851	2411.851	2411.851	2411.851	2411.851	1056
Cable gland, brass M50 x 1.5	2 pc(s).	2411.861	2411.861	2411.861	2411.861	2411.861	2411.861	1056
Cable gland, brass M63 x 1.5	1 pc(s).	2411.871	2411.871	2411.871	2411.871	2411.871	2411.871	1056
Cable gland, polyamide M12 x 1.5	50 pc(s).	2411.601	2411.601	2411.601	2411.601	2411.601	2411.601	1056
Cable gland, polyamide M16 x 1.5	50 pc(s).	2411.611	2411.611	2411.611	2411.611	2411.611	2411.611	1056
Cable gland, polyamide M20 x 1.5	50 pc(s).	2411.621	2411.621	2411.621	2411.621	2411.621	2411.621	1056
Cable gland, polyamide M25 x 1.5	25 pc(s).	2411.631	2411.631	2411.631	2411.631	2411.631	2411.631	1056
Cable gland, polyamide M32 x 1.5	15 pc(s).	2411.641	2411.641	2411.641	2411.641	2411.641	2411.641	1056
Cable gland, polyamide M40 x 1.5	5 pc(s).	2411.651	2411.651	2411.651	2411.651	2411.651	2411.651	1056
Cable gland, polyamide M50 x 1.5	5 pc(s).	2411.661	2411.661	2411.661	2411.661	2411.661	2411.661	1056
Cable gland, polyamide M63 x 1.5	3 pc(s).	2411.671	2411.671	2411.671	2411.671	2411.671	2411.671	1056

¹⁾ The perforated door strip is required for the installation

²⁾ For two-door enclosures: Installation in the lockable door

Hose-proof hood

Increases the protection category and facilitates cleaning, see page 538



Baying enclosure system VX25



System accessories Page 877 VX25 sheet steel Page 116 Hygienic Design Page 217 VX SE stainless steel Page 248

Material and surface finish:

- Enclosure frame: Stainless steel 1.4301 (AISI 304), 1.5 mm
- Roof: Stainless steel 1.4301 (AISI 304), 1.5 mm, exterior brushed, grain size 400
- Door: Stainless steel 1.4301 (AISI 304), 2 mm, exterior brushed, grain size 400
- Rear panel: Stainless steel 1.4301 (AISI 304), 1.5 mm, exterior brushed, grain size 400
- Gland plates: Stainless steel 1.4301 (AISI 304), 1.5 mm
- Mounting plate: Sheet steel, 3 mm, zinc-plated, passivated

Protection category IP to IEC 60 529:

- IP 55

Protection category NEMA:

- NEMA 12

Supply includes:

- Enclosure frame
- Door(s) (r/h hinge, may be swapped to opposite side)
- Roof plate
- Gland plates
- Rear panel
- Mounting plate
- Lock: 3 mm double-bit
- 2 punched rails 18 x 39 mm

Note:

- Due to the hardness of the material, we recommend using metal multi-tooth screw 2486.400 for the interior installation

Approvals:

- UL
- cUL
- DNV-GL

Further approvals can be found on the Internet.

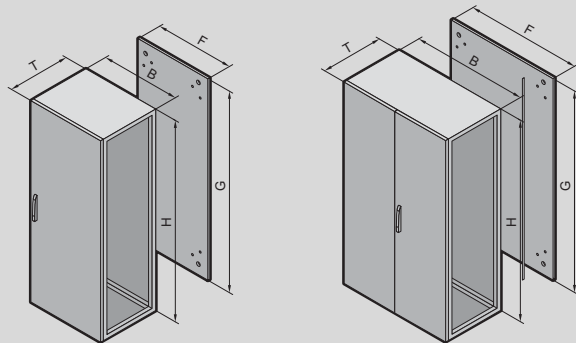

Baying enclosure system VX25

Basic enclosure, height 1800 mm, depth 400 mm, stainless steel

Width (B) mm	Packs of	800	1200	Page
Height (H) mm		1800	1800	
Depth (T) mm		400	400	
Mounting plate width (F) mm		699	1099	
Mounting plate height (G) mm		1696	1696	
Model No.	1 pc(s).	8454.000	8456.000	
Weight kg		110.0	167.0	
Product-specific scope of supply				
Door(s)		1	2	
Accessories				
Base/plinth corner pieces with base/plinth trim panels, front and rear, 100 mm	2 pc(s).	8620.051	8620.053	886
Base/plinth trim panels, sides, 100 mm	2 pc(s).	8620.070	8620.070	887
Base/plinth corner pieces with base/plinth trim panels, front and rear, 200 mm	2 pc(s).	8620.061	8620.063	886
Base/plinth trim panels, sides, 200 mm	2 pc(s).	8620.080	8620.080	887
Levelling feet	4 pc(s).	8100.780	8100.780	892
Punched section with mounting flange 23 x 89 mm, stainless steel, in the depth	4 pc(s).	8100.730	8100.730	991
Side panels, screw-fastened, stainless steel	2 pc(s).	8700.030	8700.030	901
Divider panel	1 pc(s).	8609.200	8609.200	905
Divider panel for module plates		-	-	
Baying bracket, internal	6 pc(s).	8617.500	8617.500	912
Baying block, internal	6 pc(s).	8617.501	8617.501	912
Baying connector, external, stainless steel	6 pc(s).	8617.503	8617.503	912
Comfort handle VX for lock inserts	1 pc(s).	8618.220	8618.220	937
Comfort handle VX for profile half-cylinders	1 pc(s).	8618.280	8618.280	937
Lock inserts		see page	see page	941, 942
180° hinges, stainless steel	4 pc(s).	8618.340	8618.340	951
Punched section with mounting flange, 14 x 39 mm, for tubular door frame	4 pc(s).	8619.730	8619.720	952
Wiring plan pocket, sheet steel, depth 35 mm	1 pc(s).	4118.500	4116.500	955
Wiring plan pocket, sheet steel, depth 90 mm	1 pc(s).	4118.000	4116.000	955
Door stay	1 pc(s).	8618.430	8618.430	956
Door stay for escape routes	1 pc(s).	8618.425	8618.425	956
Ride-up roller	10 pc(s).	8618.420	8618.420	956
Mounting plate infill	1 pc(s).	4590.700	4590.700	971
Punched section with mounting flange 18 x 64 mm for the outer level, in the width	4 pc(s).	8617.040	8617.060	990
Punched section with mounting flange 18 x 64 mm for the outer level, in the depth	4 pc(s).	8617.010	8617.010	990
Punched section with mounting flange 23 x 64 mm for the inner level, in the width	4 pc(s).	8617.140	8617.160	991
Punched section with mounting flange 23 x 64 mm for the inner level, in the depth	4 pc(s).	8617.110	8617.110	991
Punched rail 18 x 39 mm for the enclosure depth	4 pc(s).	8617.700	8617.700	993
Support strip for the enclosure depth	20 pc(s).	4694.000	4694.000	994
C rail 30/15, for the enclosure width	6 pc(s).	4945.000	4947.000	996
Support rail 48 x 26 mm, for the enclosure width	2 pc(s).	8617.810	8617.830	996
LED system light		see page	see page	1014
Earth straps		see page	see page	1033
Section for cable entry, centre		8618.801	8618.803	1045
	Packs of	2 pc(s).	4 pc(s).	
Section for cable entry, rear		8618.811	8618.813	1045
	Packs of	2 pc(s).	4 pc(s).	
Cable duct		see page	see page	1058
Metal multi-tooth screws	300 pc(s).	2486.400	2486.400	1004
Cable clamp rail, right angle section	2 pc(s).	8619.420	8619.440	1059

Baying enclosure system VX25

Basic enclosure, height 1800 mm, depth 500 mm, stainless steel

Width (B) mm	Packs of	600	800	1200	Page
Height (H) mm		1800	1800	1800	
Depth (T) mm		500	500	500	
Mounting plate width (F) mm		499	699	1099	
Mounting plate height (G) mm		1696	1696	1696	
Model No.	1 pc(s).	8457.000	8455.000	8453.000	
Weight kg		91.8	113.0	172.0	
Product-specific scope of supply					
Door(s)		1	1	2	
Accessories					
Base/plinth corner pieces with base/plinth trim panels, front and rear, 100 mm	2 pc(s).	8620.050	8620.051	8620.053	886
Base/plinth trim panels, sides, 100 mm	2 pc(s).	8620.071	8620.071	8620.071	887
Base/plinth corner pieces with base/plinth trim panels, front and rear, 200 mm	2 pc(s).	8620.060	8620.061	8620.063	886
Base/plinth trim panels, sides, 200 mm	2 pc(s).	8620.081	8620.081	8620.081	887
Levelling feet	4 pc(s).	8100.780	8100.780	8100.780	892
Punched section with mounting flange 23 x 89 mm, stainless steel, in the depth	4 pc(s).	8100.731	8100.731	8100.731	991
Side panels, screw-fastened, stainless steel	2 pc(s).	8700.040	8700.040	8700.040	901
Divider panel	1 pc(s).	8609.201	8609.201	8609.201	905
Divider panel for module plates	1 pc(s).	8609.210	8609.210	8609.210	906
Baying bracket, internal	6 pc(s).	8617.500	8617.500	8617.500	912
Baying block, internal	6 pc(s).	8617.501	8617.501	8617.501	912
Baying connector, external, stainless steel	6 pc(s).	8617.503	8617.503	8617.503	912
Comfort handle VX for lock inserts	1 pc(s).	8618.220	8618.220	8618.220	937
Comfort handle VX for profile half-cylinders	1 pc(s).	8618.280	8618.280	8618.280	937
Lock inserts		see page	see page	see page	941, 942
180° hinges, stainless steel	4 pc(s).	8618.340	8618.340	8618.340	951
Punched section with mounting flange, 14 x 39 mm, for tubular door frame	4 pc(s).	8619.720	8619.730	8619.720	952
Wiring plan pocket, sheet steel, depth 35 mm	1 pc(s).	4116.500	4118.500	4116.500	955
Wiring plan pocket, sheet steel, depth 90 mm	1 pc(s).	4116.000	4118.000	4116.000	955
Door stay	1 pc(s).	8618.430	8618.430	8618.430	956
Door stay for escape routes	1 pc(s).	8618.425	8618.425	8618.425	956
Ride-up roller	10 pc(s).	8618.420	8618.420	8618.420	956
Mounting plate infill	1 pc(s).	4590.700	4590.700	4590.700	971
Punched section with mounting flange 18 x 64 mm for the outer level, in the width	4 pc(s).	8617.030	8617.040	8617.060	990
Punched section with mounting flange 18 x 64 mm for the outer level, in the depth	4 pc(s).	8617.020	8617.020	8617.020	990
Punched section with mounting flange 23 x 64 mm for the inner level, in the width	4 pc(s).	8617.130	8617.140	8617.160	991
Punched section with mounting flange 23 x 64 mm for the inner level, in the depth	4 pc(s).	8617.120	8617.120	8617.120	991
Punched rail 18 x 39 mm for the enclosure depth	4 pc(s).	8617.710	8617.710	8617.710	993
Support strip for the enclosure depth	20 pc(s).	4695.000	4695.000	4695.000	994
C rail 30/15, for the enclosure width	6 pc(s).	4944.000	4945.000	4947.000	996
Support rail 48 x 26 mm, for the enclosure width	2 pc(s).	8617.800	8617.810	8617.830	996
LED system light		see page	see page	see page	1014
Earth straps		see page	see page	see page	1033
Section for cable entry, centre		8618.800	8618.801	8618.803	1045
	Packs of	2 pc(s).	2 pc(s).	4 pc(s).	
Section for cable entry, rear		8618.810	8618.811	8618.813	1045
	Packs of	2 pc(s).	2 pc(s).	4 pc(s).	
Cable duct		see page	see page	see page	1058
Metal multi-tooth screws	300 pc(s).	2486.400	2486.400	2486.400	1004
Cable clamp rail, right angle section	2 pc(s).	8619.410	8619.420	8619.440	1059

Baying enclosure system VX25

Basic enclosure, height 2000 mm, depth 600 mm, stainless steel

Width (B) mm	Packs of	600	800	1200	Page
Height (H) mm		2000	2000	2000	
Depth (T) mm		600	600	600	
Mounting plate width (F) mm		499	699	1099	
Mounting plate height (G) mm		1896	1896	1896	
Model No.	1 pc(s).	8452.000	8450.000	8451.000	
Weight kg		101.0	126.0	191.0	
Product-specific scope of supply					
Door(s)		1	1	2	
Accessories					
Base/plinth corner pieces with base/plinth trim panels, front and rear, 100 mm	2 pc(s).	8620.050	8620.051	8620.053	886
Base/plinth trim panels, sides, 100 mm	2 pc(s).	8620.072	8620.072	8620.072	887
Base/plinth corner pieces with base/plinth trim panels, front and rear, 200 mm	2 pc(s).	8620.060	8620.061	8620.063	886
Base/plinth trim panels, sides, 200 mm	2 pc(s).	8620.082	8620.082	8620.082	887
Levelling feet	4 pc(s).	8100.780	8100.780	8100.780	892
Punched section with mounting flange 23 x 89 mm, stainless steel, in the depth	4 pc(s).	8100.732	8100.732	8100.732	991
Side panels, screw-fastened, stainless steel	2 pc(s).	8700.050	8700.050	8700.050	901
Divider panel	1 pc(s).	8609.205	8609.205	8609.205	905
Divider panel for module plates	1 pc(s).	8609.213	8609.213	8609.213	906
Baying bracket, internal	6 pc(s).	8617.500	8617.500	8617.500	912
Baying block, internal	6 pc(s).	8617.501	8617.501	8617.501	912
Baying connector, external, stainless steel	6 pc(s).	8617.503	8617.503	8617.503	912
Comfort handle VX for lock inserts	1 pc(s).	8618.220	8618.220	8618.220	937
Comfort handle VX for profile half-cylinders	1 pc(s).	8618.280	8618.280	8618.280	937
Lock inserts		see page	see page	see page	941, 942
180° hinges, stainless steel	4 pc(s).	8618.340	8618.340	8618.340	951
Punched section with mounting flange, 14 x 39 mm, for tubular door frame	4 pc(s).	8619.720	8619.730	8619.720	952
Wiring plan pocket, sheet steel, depth 35 mm	1 pc(s).	4116.500	4118.500	4116.500	955
Wiring plan pocket, sheet steel, depth 90 mm	1 pc(s).	4116.000	4118.000	4116.000	955
Door stay	1 pc(s).	8618.430	8618.430	8618.430	956
Door stay for escape routes	1 pc(s).	8618.425	8618.425	8618.425	956
Ride-up roller	10 pc(s).	8618.420	8618.420	8618.420	956
Mounting plate infill	1 pc(s).	4591.700	4591.700	4591.700	971
Punched section with mounting flange 18 x 64 mm for the outer level, in the width	4 pc(s).	8617.030	8617.040	8617.060	990
Punched section with mounting flange 18 x 64 mm for the outer level, in the depth	4 pc(s).	8617.030	8617.030	8617.030	990
Punched section with mounting flange 23 x 64 mm for the inner level, in the width	4 pc(s).	8617.130	8617.140	8617.160	991
Punched section with mounting flange 23 x 64 mm for the inner level, in the depth	4 pc(s).	8617.130	8617.130	8617.130	991
Punched rail 18 x 39 mm for the enclosure depth	4 pc(s).	8617.720	8617.720	8617.720	993
Support strip for the enclosure depth	20 pc(s).	4696.000	4696.000	4696.000	994
C rail 30/15, for the enclosure width	6 pc(s).	4944.000	4945.000	4947.000	996
Support rail 48 x 26 mm, for the enclosure width	2 pc(s).	8617.800	8617.810	8617.830	996
LED system light		see page	see page	see page	1014
Earth straps		see page	see page	see page	1033
Section for cable entry, centre		8618.800	8618.801	8618.803	1045
	Packs of	2 pc(s).	2 pc(s).	4 pc(s).	
Section for cable entry, rear		8618.810	8618.811	8618.813	1045
	Packs of	2 pc(s).	2 pc(s).	4 pc(s).	
Cable duct		see page	see page	see page	1058
Metal multi-tooth screws	300 pc(s).	2486.400	2486.400	2486.400	1004
Cable clamp rail, right angle section	2 pc(s).	8619.410	8619.420	8619.440	1059

Baying enclosure system VX25



System accessories Page 877 Cable entry Page 1044 VX SE IP 66/NEMA 4 Page 147

Material and surface finish:

- Enclosure frame: Stainless steel 1.4301 (AISI 304), 1.5 mm
- Roof: Stainless steel 1.4301 (AISI 304), 1.5 mm, exterior brushed, grain size 400
- Door: Stainless steel 1.4301 (AISI 304), 2 mm, exterior brushed, grain size 400
- Rear panel: Stainless steel 1.4301 (AISI 304), 1.5 mm, exterior brushed, grain size 400
- Gland plates: Stainless steel 1.4301 (AISI 304), 1.5 mm
- Mounting plate: Sheet steel, 3 mm, zinc-plated, passivated

Supply includes:

- Enclosure frame
- Door(s) (r/h hinge, may be swapped to opposite side)
- Roof
- Gland plate
- Rear panel
- Mounting plate
- Lock: 3 mm double-bit
- 2 punched rails 18 x 39 mm
- Accessory kit for side panels for upgrading to IP 66/NEMA 4X
- Baying seal

Note:

- Due to the hardness of the material, we recommend using metal multi-tooth screw 2486.400 for the interior installation
- The standard baying connectors VX for bayed suites may be used while maintaining the protection category IP 66/ NEMA 4X

Approvals:

- UL
- cUL
- EAC

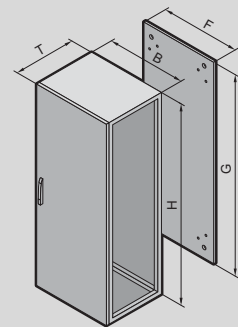

Protection category IP to IEC 60 529:

- IP 66

Protection category NEMA:

- NEMA 4X

IP 66/NEMA 4X, stainless steel

Width (B) mm	Packs of	800	Page
Height (H) mm		2000	
Depth (T) mm		600	
Mounting plate width (F) mm		699	
Mounting plate height (G) mm		1896	
Model No.	1 pc(s).	8458.000	
Weight kg		129.0	
Accessories			
Base/plinth corner pieces with base/plinth trim panels, front and rear, 100 mm	2 pc(s).	8620.051	886
Base/plinth trim panels, sides, 100 mm	2 pc(s).	8620.072	887
Base/plinth corner pieces with base/plinth trim panels, front and rear, 200 mm	2 pc(s).	8620.061	886
Base/plinth trim panels, sides, 200 mm	2 pc(s).	8620.082	887
Punched section with mounting flange 23 x 89 mm, stainless steel, in the depth	4 pc(s).	8100.732	991
Side panels, screw-fastened, stainless steel	2 pc(s).	8700.050	901
Baying bracket, internal	6 pc(s).	8617.500	912
Baying block, internal	6 pc(s).	8617.501	912
Comfort handle VX for lock inserts	1 pc(s).	8618.220	937
Comfort handle VX for profile half-cylinders	1 pc(s).	8618.280	937
Lock inserts		see page	941, 942
Wiring plan pocket, sheet steel, depth 35 mm	1 pc(s).	4118.500	955
Wiring plan pocket, sheet steel, depth 90 mm	1 pc(s).	4118.000	955
LED system light		see page	1014
Cable duct		see page	1058
Cable clamp rail, right angle section	2 pc(s).	8619.420	1059

Cooling units Blue e+, stainless steel

Optimum climate control for stainless steel applications,
see page 486



Free-standing enclosure system VX SE



System accessories Page 877 VX SE stainless steel Page 142 Lock systems Page 936 Rail systems Page 986

Material and surface finish:

- Enclosure: Stainless steel 1.4301 (AISI 304), 1.5 mm, exterior brushed, grain size 400
- Door: Stainless steel 1.4301 (AISI 304), 2 mm, exterior brushed, grain size 400
- Rear panel: Stainless steel 1.4301 (AISI 304), 1.5 mm, exterior brushed, grain size 400
- Mounting plate: Sheet steel, 3 mm, zinc-plated, passivated
- Gland plates: Stainless steel 1.4301 (AISI 304), 1.5 mm, uncoated

Protection category IP to IEC 60 529:

- IP 55

Protection category NEMA:

- NEMA 12

Supply includes:

- Enclosure, solid top and sides
- Door(s)
- R/h door hinge with single-door enclosures, may be swapped to opposite side
- Rear panel, detachable
- Mounting plate
- Gland plates
- Lock: 3 mm double-bit
- 2 punched rails 18 x 39 mm

Note:

- Due to the hardness of the material, we recommend using metal multi-tooth screw 2486.400 for the interior installation

Approvals:

- UL
- cUL

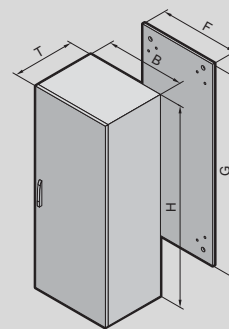

Free-standing enclosure system VX SE

Basic enclosure, stainless steel

Width (B) mm	Packs of	600	600	800	800	1000	1200	Page
Height (H) mm		1600	1800	1800	2000	1800	2000	
Depth (T) mm		400	500	500	600	400	500	
Mounting plate width (F) mm		499	499	699	699	899	1099	
Mounting plate height (G) mm		1496	1696	1696	1896	1696	1896	
Model No.	1 pc(s).	5850.600	5851.600	5852.600	5853.600	5854.600	5855.600	
Door(s)		1	1	1	1	1	2	
Accessories								
Base/plinth corner pieces with base/plinth trim panels, front and rear, 100 mm	2 pc(s).	8620.050	8620.050	8620.051	8620.051	8620.052	8620.053	886
Base/plinth trim panels, sides, 100 mm	2 pc(s).	8620.070	8620.071	8620.071	8620.072	8620.070	8620.071	887
Base/plinth corner pieces with base/plinth trim panels, front and rear, 200 mm	2 pc(s).	8620.060	8620.060	8620.061	8620.061	8620.062	8620.063	886
Base/plinth trim panels, sides, 200 mm	2 pc(s).	8620.080	8620.081	8620.081	8620.082	8620.080	8620.081	887
Levelling feet	4 pc(s).	8100.780	8100.780	8100.780	8100.780	8100.780	8100.780	892
Comfort handle for lock inserts	1 pc(s).	8611.330	8611.330	8611.330	8611.330	8611.330	8611.330	938
Comfort handle for profile half-cylinders	1 pc(s).	8611.340	8611.340	8611.340	8611.340	8611.340	8611.340	938
Lock inserts	1 pc(s).	see page	see page	see page	see page	see page	see page	941, 942
180° hinges	4 pc(s).	8701.180	8701.180	8701.180	8701.180	8701.180	8701.180	951
Punched section with mounting flange, 14 x 39 mm, for door	4 pc(s).	8619.720	8619.720	8619.730	8619.730	8619.750	8619.720	952
Wiring plan pocket, depth 35 mm	1 pc(s).	4116.500	4116.500	4118.500	4118.500	–	4116.500	955
Wiring plan pocket, depth 90 mm	1 pc(s).	4116.000	4116.000	4118.000	4118.000	4124.000	4116.000	955
Door stay	5 pc(s).	4583.000	4583.000	4583.000	4583.000	4583.000	4583.000	956
Door stay for escape routes	1 pc(s).	4583.500	4583.500	4583.500	4583.500	4583.500	4583.500	956
Ride-up roller	10 pc(s).	4538.000	4538.000	4538.000	4538.000	4538.000	4538.000	956
Adaptor rail VX to fit enclosure height	4 pc(s).	8617.750 ²⁾	8617.750	8617.750	8617.751	8617.750	8617.751	995
Punched section with mounting flange 17 x 73 mm for the inner level, in the depth	4 pc(s).	8612.040	8612.050	8612.050	8612.060	8612.040	8612.050	992
Punched section with mounting flange 17 x 73 mm for the outer level, in the depth	4 pc(s).	8612.140	8612.150	8612.150	8612.160	8612.140	8612.150	992
Punched section with mounting flange 23 x 64 mm for the inner level, in the depth ¹⁾	4 pc(s).	8617.110	8617.120	8617.120	8617.130	8617.110	8617.120	991
Punched section with mounting flange 23 x 64 mm for the inner level, in the width ¹⁾	4 pc(s).	8617.130	8617.130	8617.140	8617.140	8617.150	8617.160	991
Punched rail 18 x 39 mm for the enclosure depth ¹⁾	4 pc(s).	8617.700	8617.710	8617.710	8617.720	8617.700	8617.710	993
Support strip for the outer level for enclosure depth	20 pc(s).	4694.000	4695.000	4695.000	4696.000	4694.000	4695.000	994
Support strip for the inner level for enclosure depth	20 pc(s).	4309.000	4596.000	4596.000	8800.130	4309.000	4596.000	994
C rail 30/15, for the enclosure width	6 pc(s).	4944.000	4944.000	4945.000	4945.000	4946.000	4947.000	996
Support rail 48 x 26 mm, for the enclosure width ¹⁾	2 pc(s).	8617.800	8617.800	8617.810	8617.810	8617.820	8617.830	996
LED system light		see page	see page	see page	see page	see page	see page	1014
Earth straps		see page	see page	see page	see page	see page	see page	1033
Cable entry plate		8619.800	8619.800	8619.801	8619.801	8619.802	8619.803	1044
	Packs of	2 pc(s).	2 pc(s).	2 pc(s).	2 pc(s).	4 pc(s).	4 pc(s).	
Cable entry grommets	8 cables, max. Ø 13 mm	25 pc(s).	4316.000	4316.000	4316.000	4316.000	4316.000	1044
	3 cables, max. Ø 21 mm	25 pc(s).	4317.000	4317.000	4317.000	4317.000	4317.000	1044
	1 cable, max. Ø 47 mm	25 pc(s).	4318.000	4318.000	4318.000	4318.000	4318.000	1044
Connector grommets	10 pc(s).	4311.000	4311.000	4311.000	4311.000	4311.000	4311.000	1044
Section for cable entry, centre		8618.800	8618.800	8618.801	8618.801	8618.802	8618.803	1045
	Packs of	2 pc(s).	2 pc(s).	2 pc(s).	2 pc(s).	4 pc(s).	4 pc(s).	
Section for cable entry, rear		8618.810	8618.810	8618.811	8618.811	8618.812	8618.813	1045
	Packs of	2 pc(s).	2 pc(s).	2 pc(s).	2 pc(s).	4 pc(s).	4 pc(s).	
Cable duct		see page	see page	see page	see page	see page	see page	1058
Cable clamp rail, right angle section	2 pc(s).	8619.410	8619.410	8619.420	8619.420	8619.430	8619.440	1059

¹⁾ The VX adaptor rail is required for installation in the vertical enclosure sections. Overview of VX SE compatible rail systems, see page 986

²⁾ The VX adaptor rail for 1800 mm high enclosures 8617.750 can be cut to length accordingly for use in 1600 mm high enclosures

Free-standing enclosure system VX SE



System accessories Page 877 VX SE stainless steel Page 142

Material and surface finish:

- Enclosure: Stainless steel 1.4301 (AISI 304), 1.5 mm, exterior brushed, grain size 400
- Door: Stainless steel 1.4301 (AISI 304), 2 mm, exterior brushed, grain size 400
- Rear panel: Stainless steel 1.4301 (AISI 304), 1.5 mm, exterior brushed, grain size 400
- Mounting plate: Sheet steel, 3 mm, zinc-plated, passivated
- Base plate: Stainless steel 1.4301 (AISI 304), 1.5 mm

Protection category IP to IEC 60 529:

- IP 66

Protection category NEMA:

- NEMA 4X

Supply includes:

- Enclosure, solid top and sides
- Door(s)
- Door hinged on the right, may be swapped to the left
- Rear panel, detachable
- Mounting plate
- Base, solid
- Lock: 3 mm double-bit
- 2 punched rails 18 x 39 mm

Note:

- Due to the hardness of the material, we recommend using metal multi-tooth screw 2486.400 for the interior installation

Approvals:

- UL
- cUL

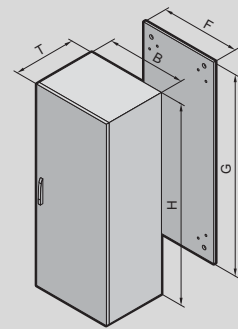

IP 66/NEMA 4X, stainless steel

Width (B) mm	Packs of	600	800	800	Page
Height (H) mm		1600	1800	2000	
Depth (T) mm		400	500	600	
Mounting plate width (F) mm		499	699	699	
Mounting plate height (G) mm		1496	1696	1896	
Model No.	1 pc(s).	5850.680	5852.680	5853.680	
Accessories					
Base/plinth corner pieces with base/plinth trim panels, front and rear, 100 mm	2 pc(s).	8620.050	8620.051	8620.051	886
Base/plinth trim panels, sides, 100 mm	2 pc(s).	8620.070	8620.071	8620.072	887
Base/plinth corner pieces with base/plinth trim panels, front and rear, 200 mm	2 pc(s).	8620.060	8620.061	8620.061	886
Base/plinth trim panels, sides, 200 mm	2 pc(s).	8620.080	8620.081	8620.082	887
Levelling feet	4 pc(s).	8100.780	8100.780	8100.780	892
Comfort handle for lock inserts	1 pc(s).	8611.330	8611.330	8611.330	938
Comfort handle for profile half-cylinders	1 pc(s).	8611.340	8611.340	8611.340	938
Lock inserts	1 pc(s).	see page	see page	see page	941, 942
Punched section with mounting flange, 14 x 39 mm, for door	4 pc(s).	8619.720	8619.730	8619.730	952
Wiring plan pocket, depth 90 mm	1 pc(s).	4116.000	4118.000	4118.000	955
Door stay	5 pc(s).	4583.000	4583.000	4583.000	956
Adaptor rail VX to fit enclosure height	4 pc(s).	8617.750 ²⁾	8617.750	8617.751	995
Punched section with mounting flange 17 x 73 mm for the inner level, in the depth	4 pc(s).	8612.040	8612.050	8612.060	992
Punched section with mounting flange 17 x 73 mm for the outer level, in the depth	4 pc(s).	8612.140	8612.150	8612.160	992
Punched section with mounting flange 23 x 64 mm for the inner level, in the depth ¹⁾	4 pc(s).	8617.110	8617.120	8617.130	991
Punched section with mounting flange 23 x 64 mm for the inner level, in the width ¹⁾	4 pc(s).	8617.130	8617.140	8617.140	991
LED system light		see page	see page	see page	1014
Earth straps		see page	see page	see page	1033
Cable clamp rail, right angle section	2 pc(s).	8619.410	8619.420	8619.420	1059

¹⁾ The VX adaptor rail is required for installation in the vertical enclosure sections. Overview of VX SE compatible rail systems, see page 986

²⁾ The VX adaptor rail for 1800 mm high enclosures 8617.750 can be cut to length accordingly for use in 1600 mm high enclosures



System accessories Page 877 Monitors, keyboards Page 1109 Climate control Page 449 One-piece consoles, sheet steel Page 161

Material:

- Enclosure: Stainless steel 1.4301 (AISI 304), 1.5 mm
- Door or double door and console lid: Stainless steel 1.4301 (AISI 304), 2.0 mm
- Mounting plate: Sheet steel, 3.0 mm

Surface finish:

- Enclosure, door, console lid and gland plates: Brushed, grain 400
- Mounting plate: Zinc-plated

Protection category IP to IEC 60 529:

- IP 55

Protection category NEMA:

- NEMA 12

Supply includes:

- Enclosure, solid back and sides
- Door or double door at front, with locking rod
- Console lid with lid stay and cam lock latched in the enclosure
- Locks with double-bit insert
- Gland plates, divided
- Mounting plate

Approvals:

- UL
- CSA
- TÜV
- Russian Maritime Register of Shipping

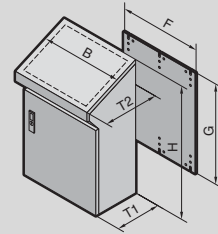

Stainless steel

Width (B) mm	Packs of	600	800	1000	1200	Page
Height (H) mm		960	960	960	960	
Depth, Bottom (T1) mm		400	400	400	400	
Depth, Top (T2) mm		480	480	480	480	
Mounting plate width (F) mm		530	730	930	1130	
Mounting plate height (G) mm		780	780	780	780	
Model No.	1 pc(s).	2683.600	2684.600	2685.600	2686.600	
Number of doors		1	1	2	2	
Weight kg		52.0	65.2	79.5	90.3	
Accessories						
Base/plinth, complete	1 pc(s).	2865.000	2869.000	2867.000	2870.000	890
Comfort handle AX	1 pc(s).	2435.300	2435.300	2435.300	2435.300	939
Support rail TS 35/15	6 pc(s).	4934.000	4935.000	4933.000	4937.000	997
LED system light		see page	see page	see page	see page	1014
Hose-proof hood		see page	see page	see page	see page	538

PC enclosure system



System accessories Page 877 Monitors, keyboards Page 1109 PC enclosure system, sheet steel Page 164

Material:

- Enclosure: Stainless steel 1.4301 (AISI 304), 1.5 mm
- Rear door: Stainless steel 1.4301 (AISI 304), 2.0 mm
- Gland plates: Stainless steel 1.4301 (AISI 304), 1.5 mm
- Monitor field: Single-pane safety glass, 4 mm

Surface finish:

- Brushed, grain 400

Protection category IP to IEC 60 529:

- IP 55

Protection category NEMA:

- NEMA 12

Supply includes:

- Enclosure, solid top and sides
- Rear door with locking rod
- Glazed door at the top, latched from the inside
- Component shelf
- Keyboard drawer with fold-down front door for handrest and mouse pad support
- Lock insert, lock no. 3524 E
- Bottom door with locking rod
- Gland plates, divided

Approvals:

- UL
- cUL

Stainless steel

Width mm	Packs of	600	Page
Height mm		1600	
Depth mm		630	
Model No.	1 pc(s).	4650.150	
Weight kg		115.0	
Accessories			
Base/plinth corner piece with base/plinth trim panels, front and rear, 100 mm, stainless steel	2 pc(s).	8620.050	886
Base/plinth trim panels, sides, 100 mm, stainless steel	2 pc(s).	8620.072	887
Levelling feet	4 pc(s).	2859.000	893
Comfort handle		see page	938
Component shelf, pull-out	1 pc(s).	6902.960	1007
Adaptor rail	4 pc(s).	8617.760	995
Partial mounting plates	1 pc(s).	8617.550	975
Punched section with mounting flange, 23 x 89 mm, stainless steel	2 pc(s).	8100.732	991
Punched section with mounting flange, 23 x 64 mm	4 pc(s).	8617.130	991
Punched section with mounting flange, 17 x 73 mm		see page	992
LED system light		see page	1014



System accessories Page 877 **Support arm system CP 40, stainless steel** Page 188 **Hygienic Design** Page 217

Benefits:

- Resistant to high-pressure cleaning: The seal lies between two surfaces and is optimally compressed by the screw fastening.
- Suitable for clean room use: Screw fastening to comply with high standards in the food industry. With plastic stoppers on the inside or hex screws on the outside.

Material:

- Stainless steel 1.4301 (AISI 304)

Surface finish:

- Brushed, grain 400

Protection category IP to

IEC 60 529:

- IP 66
- IP X9

Clean room class:

- Air purity class 1 to DIN EN ISO 14 644-1

Stainless steel

Width mm	Packs of	530	Page
Height mm		360	
Depth mm		120	
Operating housing for panel width mm		482.6	
Operating housing for panel height mm		310	
Installation depth mm		115	
Support arm connection		Top or bottom (by rotating the enclosure)	
Model No.	1 pc(s).	6681.000	
Weight kg		9.3	

Command panel housing with door



System accessories Page 877 Support arm system CP 40, stainless steel Page 188 Hygienic Design Page 217

Material:

- Enclosure and door: Stainless steel 1.4301 (AISI 304)
- Handle strips: Plastic approved for use with foodstuffs, dyed blue

Surface finish:

- Brushed, grain 400

Colour:

- Handle strips: similar to RAL 5002

Protection category IP to IEC 60 529:

- IP 66

Protection category NEMA:

- NEMA 12

Supply includes:

- Enclosure of all-round solid construction
- Cut-out and reinforcement for support arm system CP 40 stainless steel
- Fastener with guide plate
- Door with sealing frame and side handle strips
- Lock: 3 mm double-bit

Note:

- The support arm connection and door hinge may be swapped over by rotating the enclosure
- 3 mm double-bit lock insert may be exchanged for 41 mm lock inserts, plastic handles and T handles, type C

Approvals:

- UL
- CSA
- TÜV

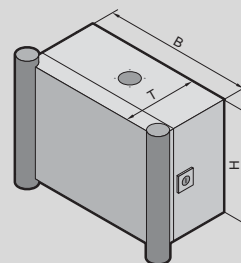

Stainless steel

Width (B) mm	Packs of	300	400	400	600	Page
Height (H) mm		300	300	400	400	
Depth (T) mm		150	150	150	150	
Model No.	1 pc(s).	6535.010	6536.010	6538.010	6539.010	
Weight kg		6.3	7.5	8.8	12.1	
Accessories						
Support rail TS 35/7.5	10 pc(s).	2316.000	2317.000	2317.000	-	997
Support rail TS 35/15	10 pc(s).	-	-	-	2319.000	997
Support strip	20 pc(s).	-	4694.000	4694.000	4696.000	994

Support arm system CP 40

Optimum interaction between operation and monitoring,
also available in stainless steel, see page 188



Rittal – The System.

Faster – better – everywhere.



Ex enclosures

Ex enclosures

Stainless steel, empty enclosure with screw-fastened cover	258
Stainless steel, empty enclosure with hinged door	259
Plastic AX, empty enclosure with hinged door.....	260
Accessories	261



Ex enclosures



System accessories Page 877

Applications:

- Zone 1 and 2 or 21 and 22 to 2014/34/EU
- Ambient temperature range: -30 °C...+80 °C
- The specified temperatures may be limited by the installed equipment
- Explosion protection category to EN 60 079: Equipment protection thanks to increased safety (Ex e), equipment protection thanks to enclosure (Ex tB)

Material:

- Enclosure: Stainless steel 1.4301 (AISI 304)
- Cover: Stainless steel 1.4301 (AISI 304), all-round foamed-in silicone seal

Surface finish:

- Enclosure: Exterior brushed, grain size 400

Protection category IP to IEC 60 529:

- IP 66

Supply includes:

- Enclosure
- Cover

Certificates:

- PTB 03 ATEX 1013U
- IEC Ex PTB 09.0033U

Approvals:

- ATEX
- IECEx PTB

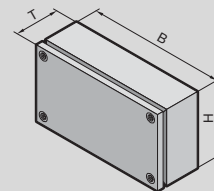

Stainless steel, empty enclosure with screw-fastened cover

Width (B) mm	Packs of	150	200	300	300	300	400	Page
Height (H) mm		150	200	150	200	300	200	
Depth (T) mm		80	80	80	80	120	120	
Model No.	1 pc(s).	9301.000	9303.000	9302.000	9304.000	9306.000	9305.000	
Weight kg		1.3	1.8	1.8	2.4	3.9	3.6	
Accessories								
Mounting plates	1 pc(s).	1560.800	1562.800	1561.800	1563.800	1567.800	1564.800	970
Wall-mounting bracket, stainless steel	4 pc(s).	1594.010	1594.010	1594.010	1594.010	1594.010	1594.010	965
Support rails TS 35/7.5	10 pc(s).	2314.000	2315.000	2316.000	2316.000	2316.000	2317.000	997
Earth straps		see page	see page	see page	see page	see page	see page	1033



System accessories Page 877

Applications:

- Zone 1 and 2 or 21 and 22 to 2014/34/EU
- Ambient temperature range: -30 °C...+80 °C
- The specified temperatures may be limited by the installed equipment
- Explosion protection category to EN 60 079: Equipment protection thanks to increased safety (Ex e), equipment protection thanks to enclosure (Ex tB)

Material:

- Enclosure: Stainless steel 1.4301 (AISI 304)
- Door: Stainless steel 1.4301 (AISI 304), all-round foamed-in silicone seal
- Mounting plate: Sheet steel

Surface finish:

- Enclosure: Brushed, grain size 400, peak-to-valley height < 0.8 µm
- Mounting plate: Zinc-plated

Protection category IP to IEC 60 529:

- IP 66

Protection category NEMA:

- NEMA 4X

Supply includes:

- Enclosure
- Door
- Mounting plate

Certificates:

- PTB 02 ATEX 1082U
- IEC Ex PTB 09.0035U

Approvals:

- UL
- cUL
- ATEX
- IECEx PTB

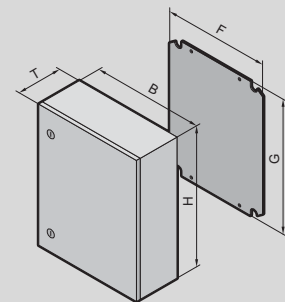

Stainless steel, empty enclosure with hinged door

Width (B) mm	Packs of	200	300	380	380	380	600	600	760	800	Page
Height (H) mm		300	380	300	380	600	600	760	760	1000	
Depth (T) mm		155	210	155	210	210	210	210	300	300	
Mounting plate width (F) mm		162	275	334	334	334	549	549	704	739	
Mounting plate height (G) mm		275	334	275	355	570	570	730	730	955	
Model No.	1 pc(s).	9401.600	9409.600	9402.600	9403.600	9404.600	9405.600	9406.600	9407.600	9408.600	
Cam lock with 3 mm double-bit insert		1	1	1	1	2	2	2	2	2	
Reinforcement section in the door		-	-	-	-	-	■	■	■	■	
Weight kg		5.0	8.1	7.8	10.1	16.9	25.2	32.5	44.1	57.8	
Accessories											
Wall mounting bracket	4 pc(s).	2433.000	2433.000	2433.000	2433.000	2433.000	2433.000	2433.000	2433.000	2433.000	261
Support rails TS 35/7.5	10 pc(s).	2315.000	2316.000	-	-	-	-	-	-	-	997
Support rails TS 35/15	10 pc(s).	-	-	-	-	-	2319.000	2319.000	-	-	997
Earth straps		see page	see page	see page	see page	see page	see page	see page	see page	see page	1033

Ex enclosures



System accessories Page 877

Applications:

- Zone 1 and 2 or 21 and 22 to 2014/34/EU
- Ambient temperature range: -30 °C...+80 °C
- The specified temperatures may be limited by the installed equipment
- Explosion protection category to EN 60 079: Equipment protection thanks to increased safety (Ex e), equipment protection thanks to enclosure (Ex tB)

Material:

- Enclosure: Fibreglass-reinforced unsaturated polyester, surface resistance: $< 10^9 \Omega$
- Door: Fibreglass-reinforced unsaturated polyester, surface resistance: $< 10^9 \Omega$ all-round foamed-in silicone seal
- Mounting plate: Sheet steel, zinc-plated, passivated

Colour:

- RAL 9011

Protection category IP to IEC 60 529:

- IP 66

Supply includes:

- Enclosure
- Door
- Mounting plate

Certificates:

Available on the Internet

Approvals:

- ATEX
 - IECEx PTB
- Further approvals can be found

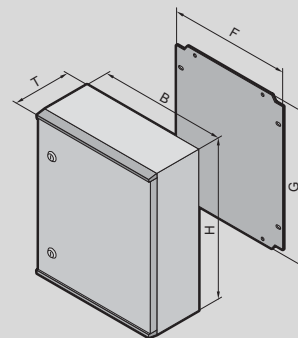

Plastic AX, empty enclosure with hinged door

Width (B) mm	Packs of	250	300	400	400	500	600	600	800	Page
Height (H) mm		350	400	400	600	500	600	800	1000	
Depth (T) mm		150	200	200	200	300	200	300	300	
Mounting plate width (F) mm		155	205	305	305	405	505	505	705	
Mounting plate height (G) mm		275	325	325	525	425	525	725	925	
Model No.	1 pc(s).	9202.100	9203.100	9204.100	9205.100	9207.100	9206.100	9208.100	9209.100	
Cam lock with 3 mm double-bit insert		1	2	2	2	2	2	3	3	
Weight kg		4.4	6.4	7.8	11.2	13.3	15.7	22.8	34.6	

Accessories

Wall mounting bracket	4 pc(s).	1485.500	1485.500	1485.500	1485.500	1485.500	1485.500	1485.500	1485.500	261
Screw for interior installation	50 pc(s).	1485.300	1485.300	1485.300	1485.300	1485.300	1485.300	1485.300	1485.300	261
Pole clamp	2 pc(s).	2584.110	2584.110	2584.110	2584.110	2584.110	2584.110	2584.110	2584.110	968
Universal bracket	4 pc(s).	1485.200	1485.200	1485.200	1485.200	1485.200	1485.200	1485.200	1485.200	97
Door stay AX	2 pc(s).	1485.100	1485.100	1485.100	1485.100	1485.100	1485.100	1485.100	1485.100	96
LED system light		-	-	2500.100	2500.100	2500.100	2500.100	2500.110	2500.110	1014

Rittal – The System.

Faster – better – everywhere.



Outdoor

Outdoor enclosures

Basic enclosures	266
Wall-mounted enclosures	269

Outdoor project solutions

Toptec	270
Multifunctional enclosures	271

At home in any outdoor application





Energy

- Mounting benefits – Flexible basic enclosure, with doors front and rear on request, for rapid interior installation and optimum on-site accessibility
- Variable base mounting – Easy to plan, because it is suitable for all site conditions: Concrete base/plinth, base plate, plastic base/plinth

Water industry

- The ideal material – Powder-coated aluminium for a long service life and corrosion resistance, plus fast machining of cut-outs
- Fast interior installation – All-round 25 mm system punchings and an extensive range of system accessories help to reduce assembly time

Telecommunications

- Fully integrated system solutions for mobile communications and broadband network installation reduce planning complexity
- Vandal-resistant – Enclosure solutions up to resistance class RC4

Telematics

- Optimum protection against corrosion – Coordinated mix of materials for heavily contaminated roadside environments helps to extend servicing intervals



Outdoor Basic enclosures – Flexibility included



Systematic roof concept

Multi-functional benefits:

- Roof projection increases the proportion of shading
- Air exchange with all-round louvred grilles
- Fan for active climate control has an IP-compatible covering



Integral transport options

- Eyebolts on the inner roof, concealed by the rain canopy
- For transporting the fully configured unit by crane



Systematic installation benefits

- System punchings in the base ensure system compatibility
- Extensive range of system-compatible accessories for individual installations



Outdoor Basic enclosures



Climate control Page 449 Outdoor housing Page 958 Cable routing Page 1044

Outdoor enclosure with 100 mm transport plinth and rain canopy with projections on all sides.

Material:

- Aluminium AlMg3

Surface finish:

- Powder-coated
- UV-resistant pure polyester

Colour:

- RAL 7035

Protection category IP to IEC 60 529:

- IP 55
- NEMA 3R

Supply includes:

- Single-walled outdoor enclosure, fully preconfigured
- Basic enclosure with three-part gland plate
- 25 mm system punchings in the roof, base, front and in the enclosure depth
- Front door(s) with door stay, swing lever handle and profile half-cylinder, lock BJ 20027
- Transport plinth with screw-fastened trim panels front and rear
- Enclosure width 1200 mm has two 600 mm wide mounting panels
- Rain canopy

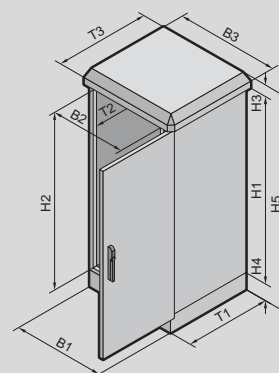

Single-walled

	Packs of	600	800	1200	Page
Width (B1) mm		600	800	1200	
Height (H1) mm		1200	1200	1200	
Depth (T1) mm		500	500	500	
Clearance width (B2) mm		512	712	512	
Clearance height (H2) mm		1112	1112	1112	
Clearance depth (T2) mm		449	449	449	
Rain canopy width (B3) mm		650	850	1250	
Rain canopy height (H3) mm		55	55	55	
Rain canopy depth (T3) mm		550	550	550	
Base/plinth height (H4) mm		100	100	100	
Overall height (H5) mm		1355	1355	1355	
Model No.	1 pc(s).	9783.530	9783.610	9784.540	
Door(s)		1	1	2	
Weight kg		38.0	49.5	66.0	
With removable centre bar, 2 lockable doors		–	–	■	
Accessories					
Mounting plate	1 pc(s).	9765.092	9765.095	9765.191	981
Enclosure heater	1 pc(s).	3105.400	3105.400	3105.400	531
Thermostat	1 pc(s).	3110.000	3110.000	3110.000	547
Profile half-cylinders	1 pc(s).	9785.040	9785.040	9785.040	942
Mounting angles, 482.6 mm (19")	2 pc(s).	7688.000	7688.000	7688.000	
Installation bracket for mounting angles, 482.6 mm (19")	2 pc(s).	7696.000	7698.000	7696.000	
LED system light		see page	see page	see page	1014

Outdoor wall-mounted enclosures



Compact enclosures AX, stainless steel Page 236 **Hygienic Design** Page 217 **Outdoor housing** Page 958

Outdoor enclosures for wall or pole mounting. Enclosure-within-an-enclosure concept, outer enclosure with cut-out at the bottom and integrated louvres on the rear panel and side panels for ventilation.

Material:

- Enclosure and mounting plate: Aluminium, AlMg3
- Door, inner enclosure: Stainless steel 1.4301 (AISI 304)

Surface finish:

- Enclosure: Powder-coated, UV-resistant pure polyester

Colour:

- RAL 7035

Protection category IP to IEC 60 529:

- IP 55

Supply includes:

- Twin-walled outdoor enclosure, fully preconfigured
- Inner enclosure with mounting plate, gland plate and security lock (CS 9791.045 with 2 security locks)
- Mounting bracket for enclosure internal thermostat or hygrostat
- Outer enclosure with designer cover and security lock 3524 E
- 2 C rails on the rear panel

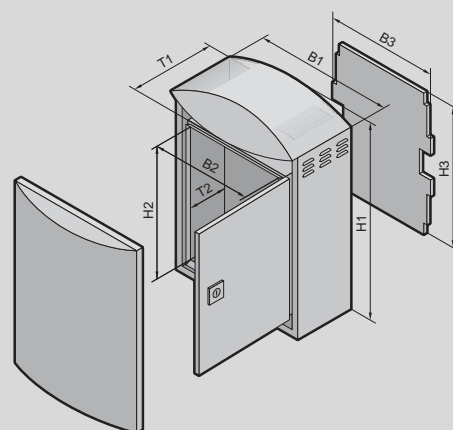

Twin-walled

Outer enclosure						
Width (B1) mm	Packs of	370	420	530	630	Page
Height (H1) mm		522	560	700	780	
Depth (T1) mm		210	210	265	380	
Inner enclosure						
Width (B2) mm		300	350	460	580	
Height (H2) mm		400	440	565	580	
Depth (T2) mm		170	170	220	333	
Clearance width mm		280	330	440	560	
Clearance height mm		380	420	545	560	
Clearance depth mm		145	145	195	308	
Mounting plate width (B3) mm		270	320	430	550	
Mounting plate height (H3) mm		380	410	535	550	
Model No.	1 pc(s).	9791.015	9791.025	9791.035	9791.045	
Accessories						
Pole clamp	2 pc(s).	2584.100	2584.100	2584.100	2584.100	968
Enclosure heater	1 pc(s).	3105.330	3105.330	3105.330	3105.330	530
Thermostat	1 pc(s).	3110.000	3110.000	3110.000	3110.000	547
Hygrostat	1 pc(s).	3118.000	3118.000	3118.000	3118.000	547
Socket	2 pc(s).	2506.120	2506.120	2506.120	2506.120	1042
LED system light		see page	see page	see page	see page	1014

Toptec project solutions

The universal platform for outdoor applications

- Weather canopy – With projection on all sides
- Chimney effect of the twin-walled structure – Reduces the influence of sunlight
- Mounting benefit – Open frame structure for fast configuration, also applies to bayed variants
- Energy-efficient – The new wall-mounted cooling unit Blue e+ Outdoor can be used worldwide, thanks to its multi-voltage capability, and is suitable for use e.g. with Toptec project solutions



Design

Enclosure type:

- Outdoor enclosure, twin-walled

Material:

- Base frame: Stainless steel
- Enclosure panels: Aluminium
- Rain canopy: Aluminium

Project solutions with multifunctional enclosures

Your platform for telecommunications solutions

- Weather canopy with ventilation
- Gland plate with cable glands
- 482.6 mm (19") mounting angles inside the enclosure, in stainless steel throughout
- Aluminium mounting plate
- Depending on the design, with single door/two doors, symmetrical or asymmetrical



Design

Enclosure type:

- Modular outdoor enclosure system, single- or twin-walled

Material:

- Base frame: Aluminium
- Enclosure and panels: Aluminium
- Rain canopy: Aluminium
- 482.6 mm (19") standard field: Stainless steel

Software for enclosures

Configurators/tools/CAD data

Enclosures

Menu-prompted configurators help you to select the right enclosure and matching standard accessories. The calculated results contain the Rittal Model Numbers for your parts list definition.

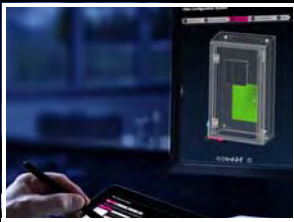

Rittal Configuration System

The latest dimension in configuration for Rittal – The System.

Simply select your preferred enclosure system and launch the configuration process. Climate control components, busbars and accessories are easily added to the enclosure without specialist product know-how, thanks to the use of plausibility-checked components. The configuration progress can be followed at any time with 3D visualisation. Cut-outs e.g. for fan-and-filter units, switches, connectors and cable entries are easily planned and positioned directly on the enclosure with the Rittal Configuration System. Parts lists, drawings and technical documents for your configuration are generated automatically.

Benefits:

- Plausibility-checked, error-free product configuration
- Control of the ongoing configuration status with 3D visualisation
- Simple planning of modifications and machining of enclosures and housings
- Order configured products directly from the Rittal online shop
- Direct data transfer of the configuration results into EPLAN Pro Panel
- Free online tool – suitable for use with any standard Web browser, no login required

Note:

- Configure online at www.rittal.com/configurators



Software for enclosures

Configurators/tools/CAD data

Human/machine interface

Operation and monitoring play an increasingly vital role in mechanical and plant engineering. Rittal meets the exacting requirements placed on the "packaging" of the sensitive yet powerful electronics with its integrated modular system at the human/machine interface.

Design, function and ergonomics are the distinguishing features of this product range.

Rittal provides free Internet planning tools to assist with planning and engineering of the command panels and support arm systems.

In this way, the right product for your customer application is achieved simply, quickly and reliably.

Command panel configurators for aluminium command panels

The online configurators for Comfort Panel and Optipanel allow you to configure individual, perfectly coordinated panel solutions. Using a catalogue of questions, the configurators automatically guide you through the individual selection masks until you have compiled a complete system. The system also has a built-in smart consistency check to ensure that your configuration is complete and error-free.

Benefits:

- Select the enclosure to match the HMI panel used (the integral database contains a variety of commercial panels from various manufacturers)
- Navigate easily through the catalogue of questions
- Quickly compile the required features
- Request a quote based on the selected data records
- Request a 3D CAD model for integration into the system design

Note:

- Optipanel and Comfort Panel:
Configure online at
www.rittal.com/configurators



Support arm configurator for CP 40/60/120/180, support section, height-adjustable

The tool is able to precisely define the correct system using important user-specific parameters such as the jib length, enclosure weight or required cable cross-sections.

Benefits:

- Individual assembly tailored to the requirements of the application
- Built-in consistency check
- The outcome is a plausibility-checked parts list plus CAD data for the configured components
- Order directly from the online shop

Note:

- Configure online at
www.rittal.com/configurators



Software for enclosures

Configurators/tools/CAD data

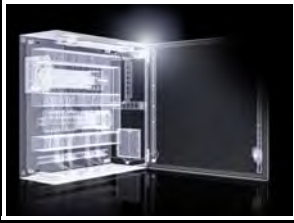

CAD data

Greater efficiency in plant design

Whichever CAD system you use, 2D and 3D CAD data provide effective support with the efficiency and productivity of your plant design work.

It includes both 2D and 3D drawings for all Rittal items plus an extensive range of system accessories.

Retrieval options:

- CAD data online: Request data from the product page on the Rittal website
- Online: Data via the Web platform "PARTcommunity"
- Online: As an app

Benefits for users of CAD data:

- All CAD data may be transferred into any commercially available CAD system, thanks to the intelligent, native 2D/3D multiCAD-compatible format.
- The accurately detailed and validated drawings allow users to create design drawings with optimum planning confidence, in a fraction of the time taken for conventional design, by simply remodelling.
- Thanks to the freely selectable level of detail in CAD models, these may be represented in a greatly simplified format, enabling huge performance enhancements among users.

Note:

- Fast online access to original data in all commercially available CAD formats directly from the Model Number



Online conversion assistant for small enclosures KX and compact enclosures AX

Convert quickly and easily with the parts list converter

- Load your complete parts list based on enclosure types KL, EB, BG, AE and CM including accessories into the conversion assistant and convert to AX/KX
- Quick search: Individual Model Numbers are also easily located using the search box
- Generate CSV parts lists for uploading into the EPLAN Data Portal basket

Benefits:

- Save time with fast, simple conversion of entire parts lists
- Directly recode project parts lists and transfer all project items into your own item database via the EPLAN Data Portal basket. There is no need to download individual macros into the item database.

Note:

- Convert directly online at www.rittal.com/ax



Product Scan app

All product information in a single scan

- Fast access to all relevant product information by scanning the QR code on the product
- Create scan lists and export the lists for subsequent use
- Track scanned products in your scan history

Note:

- Downloaded free from the App Store and from the Google Play Store



Android app



iPhone app

Reliable engineering

The ideal tools for conversion and planning,
see page 1160

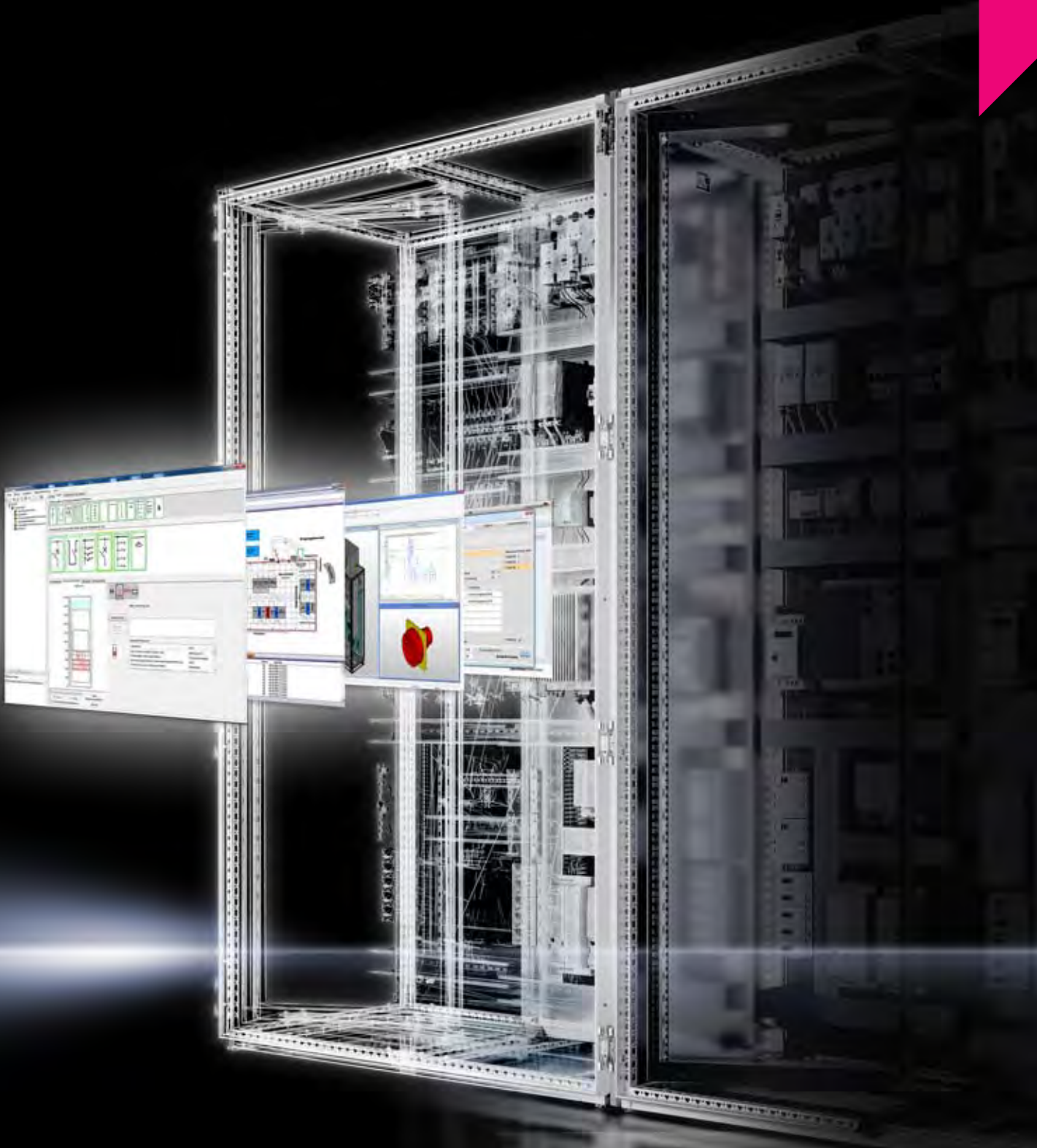

Rittal – The System.

Faster – better – everywhere.



ENCLOSURES

POWER DISTRIBUTION

CLIMATE CONTROL

FRIEDHELM LOH GROUP

POWER DISTRIBUTION

RiLine busbar systems

Overview	281
RiLine Compact busbar system	283
Mini-PLS busbar system (40 mm)	294
RiLine busbar system (60 mm)	299

VX25 Ri4Power

Modular enclosures	132
Installation accessories for modular front design	925
Fuse-switch-disconnector enclosures	134
Overview	361
Ri4Power busbar system (185 mm)	362
Busbar systems (100/185/150 mm)	388
Flat-PLS busbar system	394
Maxi-PLS busbar system	401
Connection components	406
Cover systems	408
Compartment configuration Form 1-4	410
Fuse-switch disconnector section	415
VX25 Ri4Power accessories	417

Distribution enclosures

Overview	419
Distribution enclosures	135
Mounting kits	420
Installation modules	421
ISV accessories	428

Power distribution software

VX25 Power Engineering	446
------------------------------	-----

Power distribution

Rittal – The System.

Faster – better – everywhere.



RiLine busbar systems				
<p>The tried-and-trusted, super-flexible power distribution systems for individual requirements. From small power distributors, to individual switchgear and controlgear, through to heavy-current power distributors for infrastructure and industry applications. Simple, secure assembly plus user-friendly planning with design verification are the distinguishing features of these systems.</p>				
Busbar system	RiLine Compact	Mini-PLS	RiLine PLS/flat copper bars	
Bar centre distance mm	–	40	60	
Rated current A up to	125	250	800, 1600	
Product characteristics	<ul style="list-style-type: none"> ■ Contact hazard-protected board with integral busbars for the safe accommodation and contacting of components ■ The board and all components are simply top-mounted; no tools required ■ Suitable for AC and DC applications 	<ul style="list-style-type: none"> ■ Space-saving design with full-surface top-mounting of the busbar supports and bar connector elements ■ Simple component installation via plug and lock action from the front ■ Optimum contact hazard protection with all-round encapsulation 	<ul style="list-style-type: none"> ■ Thanks to the special styling of the PLS special busbars, top-mounting with components in the support area is not a problem ■ Optimum contact hazard protection with all-round encapsulation ■ Suitable for AC and DC applications 	
From page	282	294	300	



VX25 Ri4Power		
<p>The tested complete solution – Enclosure and bar system. Mutual interference between electrical equipment in low-voltage switchgear systems has already been tested to IEC 61 439 and confirmed with a design verification.</p>	<p>Modular system for low-voltage switchgear with design verification to IEC 61 439-1/-2 and DIN EN 61 439-1/-2 plus power distributors and structured system solutions for switchgear with 1-4b Form separation.</p>	<p>ISV distribution enclosures for standard-compliant power supply in buildings and industry. Flexible configuration with practical power distribution modules.</p>
<p>Flat copper busbars</p>	<p>Flat copper busbars</p>	<p>Flat copper busbars</p>
<p>185</p>	<p>60, 70, 80, 185</p>	<p>60, 100, 185</p>
<p>2100</p>	<p>6300</p>	<p>–</p>
<ul style="list-style-type: none"> ■ Supports top-mounting of the busbar supports with components on the cover system pitch pattern ■ Integral busbar shielding in the cover section to prevent accidental arcing ■ Top-mounting of the cover section and quick retrofitting of components without removing the cover section 	<ul style="list-style-type: none"> ■ Tested system solutions to the internationally valid standard IEC 61 439-1 and simple creation of the design verification ■ High levels of short-circuit withstand strength up to I_{cw} 100 kA for 1 sec./I_{pk} 220 kA ■ Tested accidental arcing protection to IEC 61 641 	<ul style="list-style-type: none"> ■ Distribution enclosures as wall-mounted and free-standing enclosures for individual population with modular elements
<p>362</p>	<p>391</p>	<p>419</p>

Rittal – The System.

Faster – better – everywhere.



Busbar systems

RiLine Compact busbar system

Board	284
Connection adaptors	285
Component adaptors	286
Component supports	288
Circuit-breaker component adaptors	289
NH fuse-switch disconnectors	290
Motor controller	291
Power pack	292
Accessories	293

Mini-PLS busbar system (40 mm)

Busbar supports	294
Special busbars E-Cu	294
Contact hazard protection	294
Busbar connection adaptors	294
Bus-mounting fuse base	295
NH fuse-switch disconnectors, size 000	295
Component adaptors	296

RiLine busbar system (60 mm)

Flat copper bar system	300
PLS busbar system	302
Connection adaptors	304
Connection adaptor expansion set	306
OM adaptors with connection cables	307
OM adaptors with spring terminals	310
OM adaptors with plug-in cable outlet	312
OM supports	313
Circuit-breaker component adaptors, 3-pole	314
Circuit-breaker component adaptors, 4-pole	317
Switchgear assignment	319
Bus-mounting fuse base	323
NH fuse-switch disconnectors, size 000	325
NH fuse-switch disconnectors, size 00 to 3	327
– With electronic fuse monitoring	329
– With electromechanical fuse monitoring	331
Smart Monitoring System	
– NH measurement module	333
– Display/power pack	334
NH slimline fuse-switch disconnectors, size 00	335
– With electronic fuse monitoring	336
Fuse holders	338
RiLine accessories	340



RiLine Compact – Power distribution in a confined space

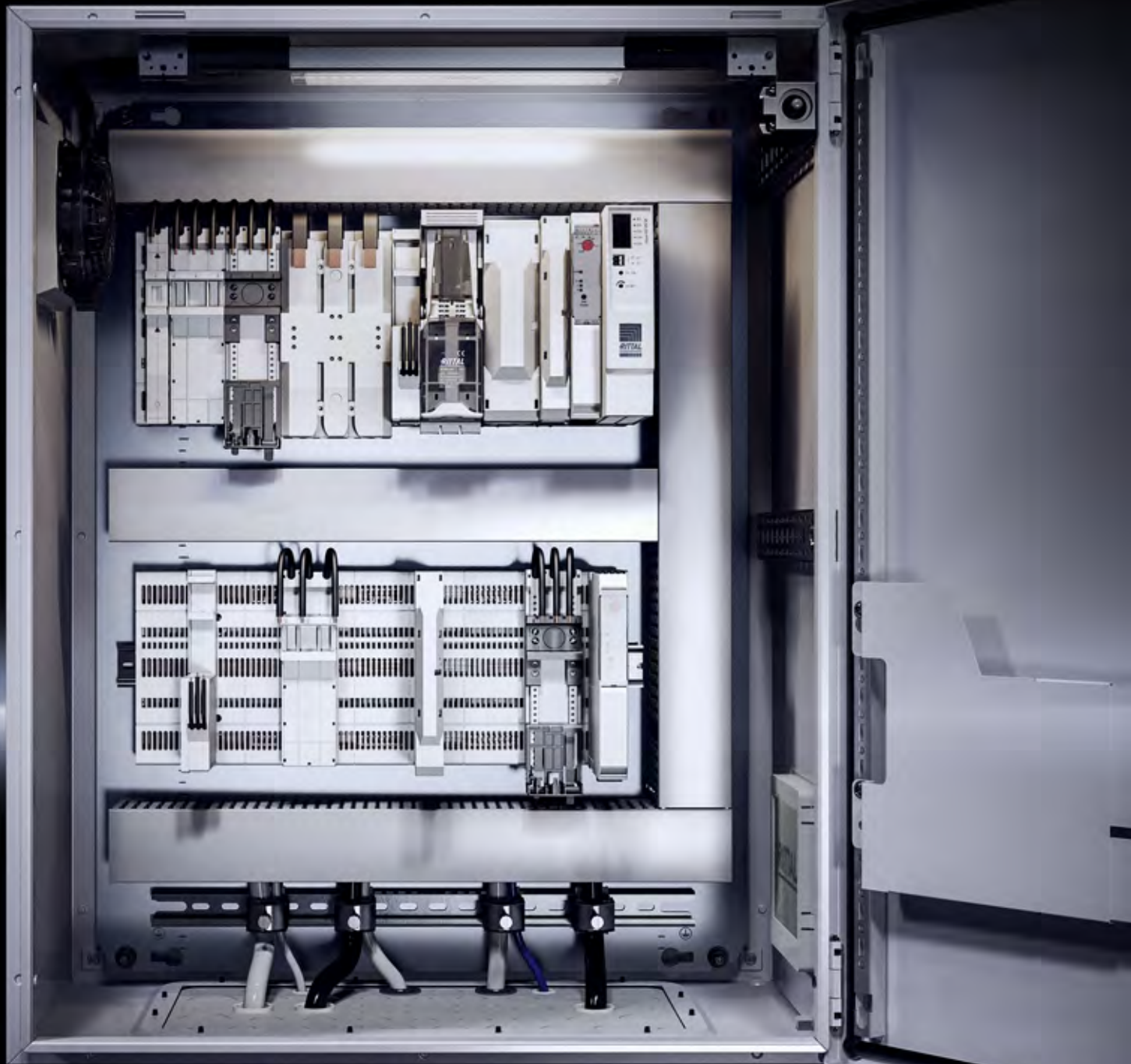

Tool-free installation made easy

- The board with integral circuit board conductors and all components are simply top-mounted; no tools required.
- Attaching the components simultaneously ensures a secure electrical connection to the all-round shock-hazard-protected board.
- The contact pitch pattern of the RiLine Compact system allows the assemblies to be positioned anywhere, in line with requirements.

Safe adaptor connection

- The RiLine Compact system adaptors support fast connection of cables and devices.
- The screw-free connection technology in the adaptor means that conductors are quickly connected, and the contact point itself is completely maintenance-free.
- The component adaptors with preassembled connection cables satisfy the special requirements of IEC 61 439 and UL.

Space-saving installation of electronic components

- The compact power supply unit provides a regulated control voltage of 24 V DC. The integral push-in terminal allows simple, fast connection of the conductors.
- The motor controller with electronic overload protection has an exceptionally space-saving design and takes up 50% less space than a conventionally wired motor controller. The hybrid technology creates a low-loss motor controller which is particularly gentle on the switching contacts. This helps to extend the service life.

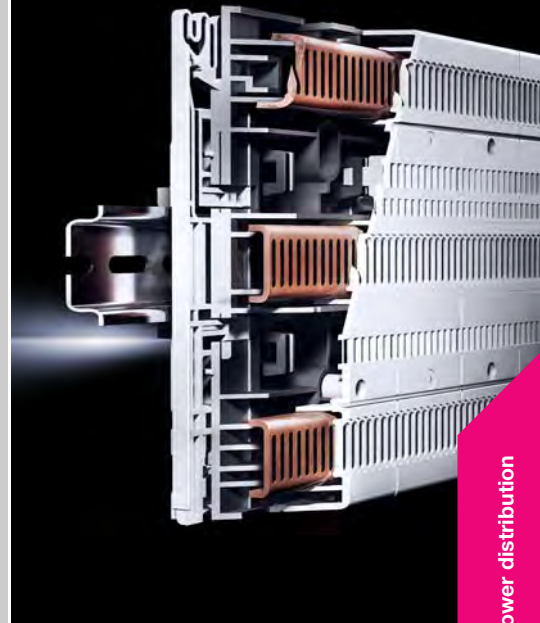

Power distribution

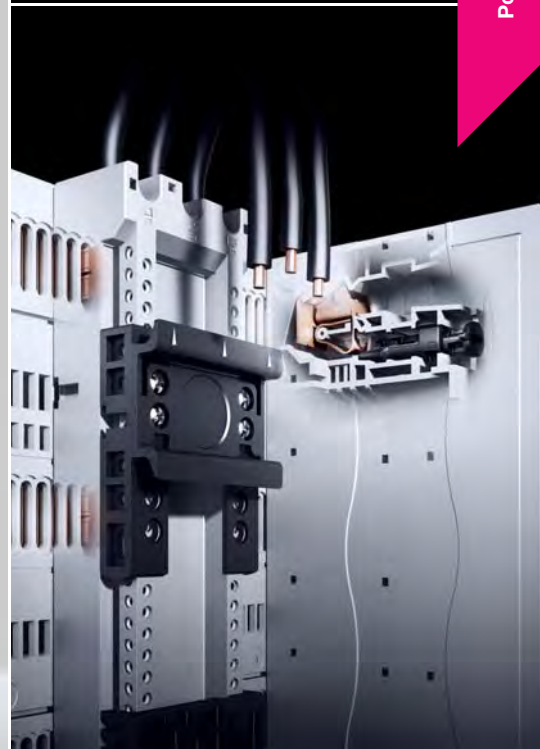

Board

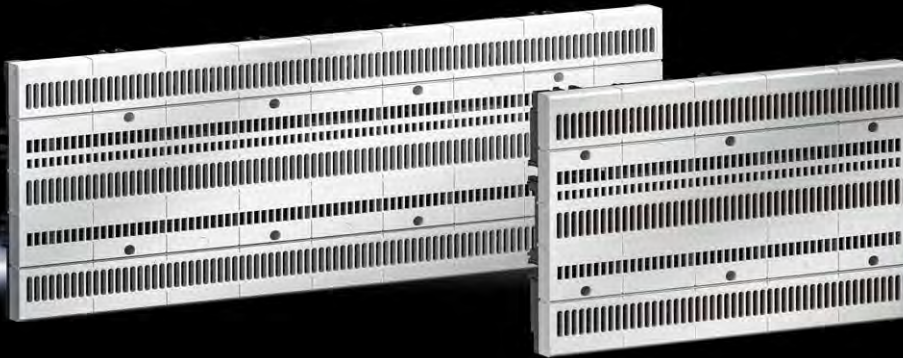

Connection adaptors Page 285 **Component adaptors** Page 286 **NH fuse-switch disconnectors** Page 290 **Motor controller/power pack** Page 291

Functions:

- Shock-hazard-protected busbar board for the safe accommodation and contacting of components, thanks to simple plug-in mounting
- Pre-punched pitch units in the board allow secure, fast positioning of components
- Reduces wiring work by contacting directly onto the board
- For snap-on mounting onto 35 x 7.5/15 mm busbars or for direct attachment to the mounting plate

Material:

- Polyamide
- Polycarbonate
- E-Cu
- Fire protection corresponding to UL 94-V0

Colour:

- RAL 7035

Protection category IP to IEC 60 529:

- IP 20

Supply includes:

- Integral busbars

Note:

- The technical data may vary for UL applications

Standards:

- UL 508
- IEC 61 439

Approvals:

- UL

RiLine Compact, 3-pole

	Packs of	125	125	Page
Rated current max. A				
Rated operating voltage V		690 (AC) 600 (DC)	690 (AC) 600 (DC)	
Number of poles		3-pole	3-pole	
Max. pitch units @ 45 mm		5	9	
Width mm		225	405	
Height mm		160	160	
Depth mm		45.1	45.1	
Model No.	1 pc(s).	9635.000	9635.010	

Connection adaptors

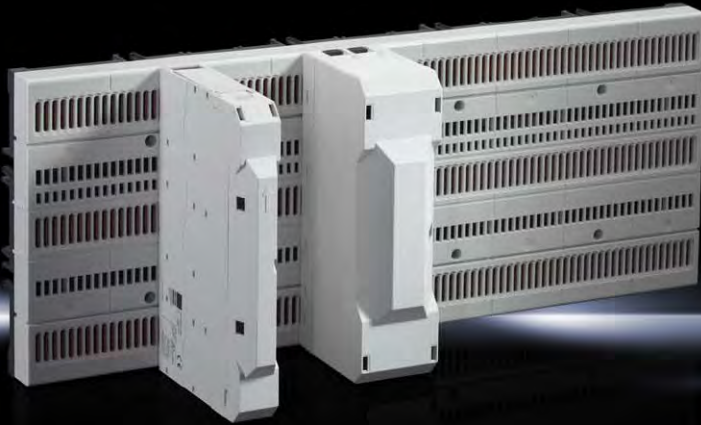

Board Page 284 **Component adaptors** Page 286 **NH fuse-switch disconnectors** Page 290 **Motor controller/power pack** Page 291

Functions:

- To supply power to the board

Material:

- Polyamide
- Fire protection corresponding to UL 94-V0

Colour:

- RAL 7035

Note:

- The technical data may vary for UL applications

Approvals:

- UL

Rated current max. 80 – 125 A, 3-pole

Rated current max. A	Packs of	80	125	Page
Rated operating voltage V, ~		690 (AC), 3~ 600 (DC), 3~	690 (AC), 3~ 600 (DC), 3~	
Number of poles		3-pole	3-pole	
Cable outlet		Top/bottom	Top/bottom	
Type of connection		Spring terminal	Box terminal	
Connection of round conductors, fine wire without wire end ferrule mm ²		1.5 - 16	6 - 50	
Connection of round conductors, fine wire with wire end ferrule mm ²		1.5 - 16	6 - 50	
Connection of round conductors, multi-wire mm ²		1.5 - 16	6 - 50	
Connection of round conductors, single-wire mm ²		1.5 - 10	6 - 50	
Connection of round conductors		AWG 6 - 16	AWG 1 - 10	
When using fine-wire round conductors 16 mm ² with wire end ferrule, we recommend the following crimping tools: Rittal 4054.004, Weidmüller PZ 16, Phoenix Contact Crimpfox 25R		■	-	
Can be used as a central infeed or as a longitudinal connector for two bayed boards		-	■	
Width mm		22.5	45	
Height mm		160	160	
Depth mm		115.5	92.5	
Model No.	4 pc(s).	9635.200	9635.210	

Component adaptors



Board Page 284 Connection adaptors Page 285 NH fuse-switch disconnectors Page 290 Motor controller/power pack Page 291

Functions:

- For mechanical attachment and direct contacting of electrical equipment on the board

Material:

- Polyamide
- Fire protection corresponding to UL 94-V0

Colour:

- RAL 7035

Note:

- Different adaptor versions are required depending on the preferred phase connection
- The technical data may vary for UL applications

Approvals:

- UL

Rated current max. 16 – 63 A, 1-pole

Design	Packs of	L1	L2	L3	L1	L2	L3	Page
Rated current max. A		16	16	16	63	63	63	
Rated operating voltage V, ~		690 (AC), 1~	690 (AC), 1~	690 (AC), 1~	690 (AC), 1~	690 (AC), 1~	690 (AC), 1~	
Number of poles		Single-pole	Single-pole	Single-pole	Single-pole	Single-pole	Single-pole	
Connection cables, Design		AWG 14	AWG 14	AWG 14	AWG 8	AWG 8	AWG 8	
Connection cables, Length mm		100	100	100	100	100	100	
Support rails Qty/height mm		1 / 10	1 / 10	1 / 10	1 / 10	1 / 10	1 / 10	
Support rail version		static	static	static	static	static	static	
Width mm		18	18	18	18	18	18	
Height mm		160	160	160	160	160	160	
Depth mm		35	35	35	35	35	35	
Model No.	6 pc(s).	9635.371	9635.372	9635.373	9635.381	9635.382	9635.383	

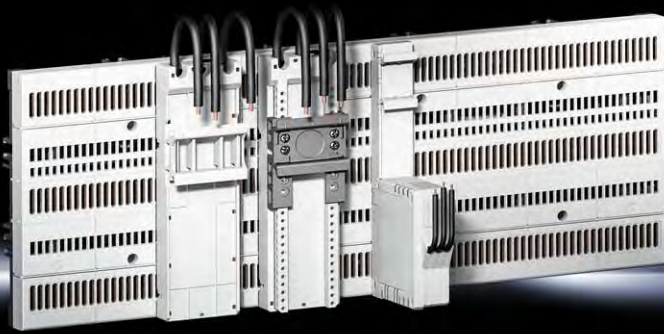

Board Page 284 Connection adaptors Page 285 NH fuse-switch disconnectors Page 290 Motor controller/power pack Page 291

Functions:

- For mechanical attachment and direct contacting of electrical equipment on the board

Material:

- Polyamide
- Fire protection corresponding to UL 94-V0

Colour:

- RAL 7035

Note:

- The technical data may vary for UL applications

Approvals:

- UL

Rated current max. 16 – 45 A, 3-pole

Design		With integral fuse holder	Basic	Basic	Comfort	Comfort	Comfort	Comfort	Page
Fuse type (class)		CC	-	-	-	-	-	-	
Rated current max. A		16	16	32	16	25	32	45	
Rated operating voltage V, ~		690 (AC), 3~600 (DC), 3~	690 (AC), 3~600 (DC), 3~	690 (AC), 3~600 (DC), 3~	690 (AC), 3~600 (DC), 3~	690 (AC), 3~600 (DC), 3~	690 (AC), 3~600 (DC), 3~	690 (AC), 3~600 (DC), 3~	
Number of poles		3-pole	3-pole	3-pole	3-pole	3-pole	3-pole	3-pole	
Fuse size mm		10 x 38	-	-	-	-	-	-	
Connection cables, Design		AWG 14	AWG 14	AWG 10	AWG 14	AWG 12	AWG 10	AWG 8	
Connection cables, Length mm		125	120	100	160	100	160	100	
Support rails Qty/height mm		1 / 10	1 / 10	1 / 10	1 / 10	1 / 10	1 / 10	1 / 10	
Support rail version		static	static	static	adjustable	adjustable	adjustable	adjustable	
Width mm		22.5	45	45	45	45	45	45	
Height mm		160	160	160	160	160	160	160	
Depth mm		80	34.5	34.5	34.5	34.5	34.5	34.5	
Model No.		9635.300	9635.310	9635.320	9635.330	9635.340	9635.350	9635.360	
	Packs of	1 pc(s).	4 pc(s).	4 pc(s).	4 pc(s).	4 pc(s).	4 pc(s).	4 pc(s).	

Accessories

Support rail	10 pc(s).	-	-	-	9635.600	9635.600	9635.600	9635.600	293
Positioner		-	-	-	see page	see page	see page	see page	293
Extension module	8 pc(s).	-	-	-	9635.630	9635.630	9635.630	9635.630	293
Extension kit	4 pc(s).	-	-	-	9635.640	9635.640	9635.640	9635.640	293

Component support

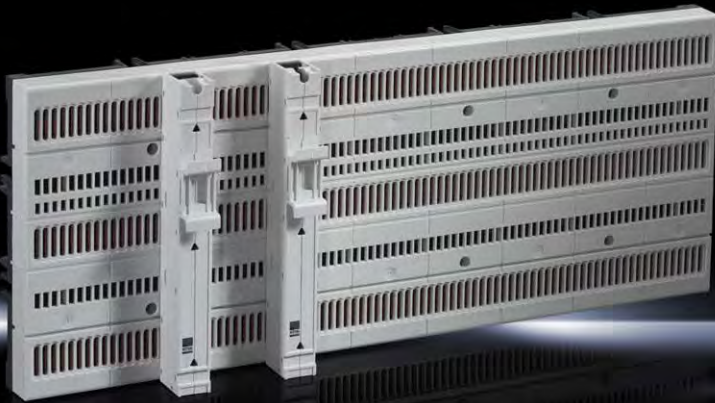

Board Page 284 **Connection adaptors** Page 285 **NH fuse-switch disconnectors** Page 290 **Motor controller/power pack** Page 291

Functions:

- For extending the mounting options on the board when using wide equipment

Material:

- Polyamide
- Fire protection corresponding to UL 94-V0

Colour:

- RAL 7035

Approvals:

- UL

without contact system

Support rails Qty/height mm	Packs of	1 / 10	Page
Support rail version		static	
Width mm		18	
Height mm		160	
Depth mm		34.5	
Model No.	6 pc(s).	9635.390	

Circuit-breaker component adaptors

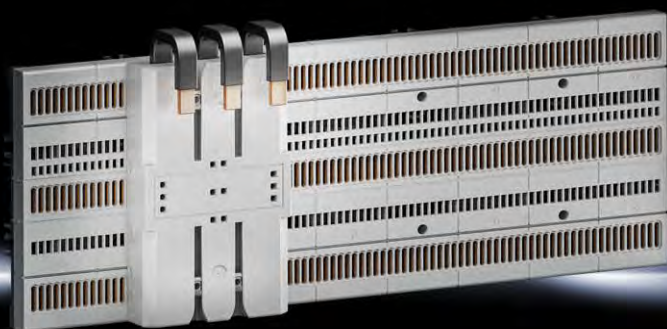

Board Page 284 Connection adaptors Page 285 NH fuse-switch disconnectors Page 290 Motor controller/power pack Page 291

Functions:

- For mechanical attachment and direct contacting of circuit-breakers on the board
- Circuit-breaker is fitted using variably adjustable fixing points (M4)

Material:

- Polyamide
- Fire protection corresponding to UL 94-V0

Colour:

- RAL 7035

Note:

- Consider the mounting distance of the circuit-breaker when selecting the circuit-breaker component adaptor
- Depending on the circuit-breaker used, there may be a reduction in output
- The technical data may vary for UL applications

Approvals:

- UL

Rated current max. 160 A, 3-pole

Rated current max. A	Packs of	160	160	Page
Rated operating voltage V, ~		690 (AC), 3~ 600 (DC), 3~	690 (AC), 3~ 600 (DC), 3~	
Number of poles		3-pole	3-pole	
Cable outlet		Top/bottom	Top/bottom	
For switchgear make (model)		ABB (XT1) Allen Bradley (140G-G) Siemens (3VA10, 3VA11, 3VA51)	ABB (XT2) Allen Bradley (140G-H) Eaton (NZM1) Schneider Electric (NSXm)	
Mounting distance mm		25	30	
Width mm		90	90	
Height mm		160	160	
Depth mm		45	45	
Model No.	1 pc(s).	9635.100	9635.110	

NH fuse-switch disconnectors



Board Page 284 **Connection adaptors** Page 285 **Component adaptors** Page 286 **Motor controller/power pack** Page 291

Functions:

- To protect connected equipment
- Integral test holes provide measurement access to the contact parts of the fuse inserts
- For cable outlet at the top, the NH fuse-switch disconnector must be mounted on the board rotated through 180°

Material:

- Polyamide
- Fire protection corresponding to UL 94-V0
- Contact tracks: Silver-plated hard copper

Colour:

- RAL 7035

Basis of test:

- IEC/DIN EN 60 947-3

Size 000

Size	Packs of	000	Page
Rated operating current max. A		125	
Rated operating voltage V, ~		690 (AC), 3~ 440 (DC), 3~	
Number of poles		3-pole	
Cable outlet		Top/bottom	
Type of connection		Box terminal	
Connection of round conductors mm ²		2.5 - 50	
Clamping area for laminated copper bars (W x H) mm		10 x 10	
Width mm		49.5	
Height mm		174.5	
Depth mm		96	
Model No.	1 pc(s).	9635.700	

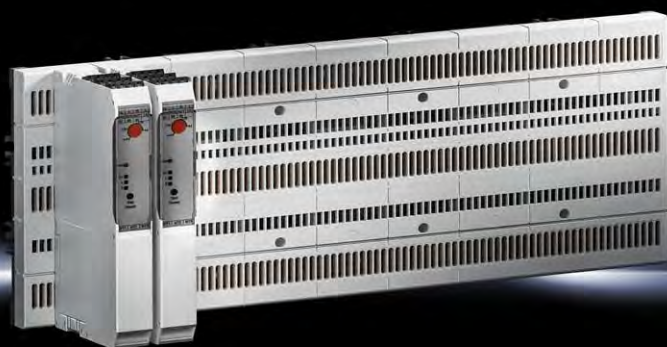

Board Page 284 Connection adaptors Page 285 Component adaptors Page 286 NH fuse-switch disconnectors Page 290

Functions:

- For controlling motors as direct or reversing starters with integral over-ride protection
- The hybrid technology used facilitates frequent switching by semi-conductors with zero wear
- During operation, mechanical contacts ensure a low heat loss
- Space-saving configuration thanks to the minimal build width

Material:

- Polyamide
- Fire protection corresponding to UL 94-V0

Colour:

- RAL 7035

Note:

- The technical data may vary for UL applications

Rated current max. 0.6 – 9 A, 3-pole

Rated current max. A	Packs of	0.6	2.4	3	9	9	Page
Rated operating voltage V, ~, Hz		500 (AC), 3~, 50/60	500 (AC), 3~, 50/60	500 (AC), 3~, 50/60	500 (AC), 3~, 50/60	500 (AC), 3~, 50/60	
Heat loss max. W		2.8	5.5	5.5	12	12	
Number of poles		3-pole	3-pole	3-pole	3-pole	3-pole	
Fuse size mm		10 x 38	10 x 38	10 x 38	10 x 38	10 x 38	
Connection of round conductors mm ²		0.14 - 2.5	0.14 - 2.5	0.14 - 2.5	0.14 - 2.5	0.14 - 2.5	
Safety integrity level (SIL) to IEC 61 508 - safe switch-off		-	-	3	-	3	
Safety integrity level (SIL) to IEC 61 508 - motor protection		-	-	2	-	2	
Adjustable current monitoring A		0.075 - 0.6	0.18 - 2.4	0.18 - 3	1.5 - 9	1.5 - 9	
Width mm		22.5	22.5	22.5	22.5	22.5	
Height mm		160	160	160	160	160	
Depth mm		114	114	114	114	114	
Approvals		UL	UL	-	UL	-	
Model No.	1 pc(s).	9635.400	9635.410	9635.415	9635.420	9635.425	

Power pack



Board Page 284 **Connection adaptors** Page 285 **Component adaptors** Page 286 **NH fuse-switch disconnectors** Page 290

Functions:

- 24 V DC control voltage supply
- Integral push-in terminal for tool-free connection of the output
- Supports parallel switching for increased output or for redundancy
- Fast commissioning, thanks to tool-free installation and automatic contacting of the power pack

Material:

- Plastic

Colour:

- RAL 7035

Protection category IP to

IEC 60 529:

- IP 20

Protection class:

- II (in the closed enclosure)

Standards:

- EN 61 000-6-2
- IEC 61 010-1 (SELV)

Directives:

- EMC Directive 2014/30/EU
- Low Voltage Directive 2014/35/EU

Approvals:

- UL

Rated operating voltage V, ~, Hz	Packs of	400, 2~, 50/60 400, 3~, 50/60 500, 2~, 50/60 500, 3~, 50/60	Page
Output voltage V (DC)		24	
Output current (max.) A		5	
Connection of round conductors mm ²		0.2 - 4	
Width mm		36	
Height mm		160	
Depth mm		159	
Operating temperature range		-25 °C...+70 °C	
Storage temperature range		-40 °C...+85 °C	
Model No.	1 pc(s).	9635.800	

RiLine Compact accessories

for component adaptors

Support rail

for Comfort component adaptors

For attaching equipment and reverser combinations.

Material:

- Polyamide
- Fire protection corresponding to UL 94-V0

Colour:

- RAL 9005

Width mm	Height mm	Packs of	Model No.
45	56	10 pc(s).	9635.600



Positioner

for Comfort component adaptors

For attaching equipment and reverser combinations.

Material:

- Polyamide
- Fire protection corresponding to UL 94-V0

Colour:

- RAL 9005

Width mm	Height mm	For switchgear make (model)	Packs of	Model No.
45	65	Siemens (S00, S0)	10 pc(s).	9635.610
45	47.5	Eaton (PKZ/PKE size 0)	10 pc(s).	9635.620



Extension module

for Comfort component adaptors

For attaching direct starters of varying lengths.

Material:

- Polyamide
- Fire protection corresponding to UL 94-V0

Colour:

- RAL 7035

Width mm	Height mm	Packs of	Model No.
45	40	8 pc(s).	9635.630



Extension kit

for Comfort component adaptors

For attaching reverser combinations with 90 mm width.

Material:

- Polyamide
- Fire protection corresponding to UL 94-V0

Colour:

- RAL 7035

Supply includes:

- 1 set consisting of 1 expansion module, 2 extension modules, 3 connection pins
- 1 set \triangleq 1 pc(s).

Width mm	Height mm	Packs of	Model No.
90	80	4 pc(s).	9635.640



Mini-PLS busbar system (40 mm)



Component adaptors Page 296 Fuse elements Page 295

Busbar supports, busbar connection adaptors

Material:

- Polyamide
- Fire protection corresponding to UL 94-V0

Colour:

- RAL 7035
- RAL 9011 (busbar connection adaptor chassis)

Contact hazard protection



Material:

- Thermally modified hard PVC
- Fire protection corresponding to UL 94-V0

Colour:

- RAL 7035

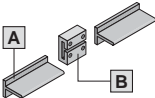
Mini-PLS busbar supports (3-pole)			
	Busbar supports, suitable for top mounting	Packs of	■
	Bar centre distance mm		40
	Approvals		UR
	Model No.	4 pc(s).	9600.000

[A] Mini-PLS special busbars E-Cu, bar thickness 3 mm, bar cross-section 120 mm ²						
	Length mm	Packs of	500	700	1100	1500
	Approvals		UR	UR	UR	UR
	Model No.	3 pc(s).	9601.000	9602.000	9603.000	9624.000
Accessories						
	Busbar connectors	Approvals		Model No.		
		UR	3 pc(s).	9611.000		

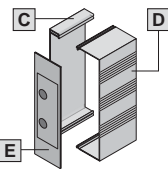
Mini-PLS contact hazard protection					
	Components	Approvals	Length mm	Packs of	Model No.
	[C] Base tray	UR	500	1 pc(s).	9605.000
			700	1 pc(s).	9606.000
			1100	1 pc(s).	9607.000
	[D] Cover section	UR	250	1 pc(s).	9608.000
			500	1 pc(s).	9609.000
[E] End cover	UR	-	2 pc(s).	9610.000	

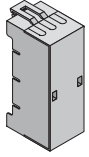
Mini-PLS busbar connection adaptors (3-pole)					Page
	Rated max. current A	Packs of	63	250	
	Rated operating voltage V, ~		690, 3~	690, 3~	
	Cable outlet		Top/bottom	Top/bottom	
	Connection of round conductors mm ²		1.5 – 35	10 – 120	
	Clamping area for laminated copper bars, W x H mm		10 x 8	17 x 15	
	Width mm		54	115	
	Height mm		160	182	
	Approvals		UR	UR	
	Model No.	1 pc(s).	9613.000	9612.000	
	Accessories				
Laminated copper bar			■	■	346



Busbar system Page 294 **Connection adaptors** Page 294 **Connection adaptors** Page 296

Bus-mounting fuse base

Material:

- Polyamide
- Fire protection corresponding to UL 94-V0

Colour:

- Chassis: RAL 9011
- Cover: RAL 7035

NH fuse-switch disconnecter

Material:

- Fibreglass-reinforced polyamide
- Fire protection corresponding to UL 94-V0
- Contact tracks: Silver-plated hard copper

Colour:

- RAL 7035

Basis of test:

- IEC/DIN EN 60 947-3
- DIN EN 60 269-2 (fuse inserts)

Busbar adaptor

Material:

- Polyamide
- Fire protection corresponding to UL 94-V0

Colour:

- RAL 9011

Mini-PLS bus-mounting fuse base (3-pole)			A	B
	Fuse insert	Packs of	D 02-E18	D 02-E18
	Rated max. current A		63	63
	Rated operating voltage V, ~		400, 3~	400, 3~
	Connection of round conductors mm ²		1.5 – 16	1.5 – 16
	Connection type		Spring terminal	Box terminal
	Width mm		39.5	38
	Height mm		189	160
	Model No.	1 pc(s).	9630.005	9630.000

NH fuse-switch disconnecter size 000 (3-pole)			
	Rated operating current max. A	Packs of	100
	Rated operating voltage V, ~		690, 3~
	Cable outlet		Top/bottom
	Connection type		Box terminal
	Connection of round conductors mm ²		1.5 – 50
	Clamping area for laminated copper bars, W x H mm		10 x 10
	Width mm		89
	Height mm		141.5
	Model No.	1 pc(s).	3431.000

Also required

Mini-PLS busbar adaptor (3-pole)			
With connection cables mm ²		35	
Width mm		90	
Height mm		160	
Model No.	1 pc(s).	9629.100	
Accessories			
Micro-switch	5 pc(s).	3071.000	358

Mini-PLS component adaptors



Busbar system Page 294 **Busbar connection adaptors** Page 294 **Fuse elements** Page 295 **Switchgear assignment** Page 297

Material:

- Polyamide (PA 6.6)
- Fire protection corresponding to UL 94-V0

Colour:

- RAL 7035
- RAL 9011 (9629.000)

Rated current max. 12 – 25 A

Rated max. current A	Packs of	12	25	25	25	25	25	25	Page	
Rated operating voltage V, ~		690, 3~	690, 3~	690, 3~	690, 3~	690, 3~	690, 3~	690, 3~		
Number of poles		3-pole	3-pole	3-pole	3-pole	3-pole	3-pole	3-pole		
Connection cables		AWG 14	AWG 12	AWG 12	AWG 12	AWG 12	AWG 12	AWG 12		
Support rails quantity/height mm		1/7.5	1/7.5	1/15	1/7.5	1/15	1/7.5	1/7.5		
Width mm		45	45	45	54	54	72	90		
Height mm		160	160	160	160	160	160	160		
Approvals		UR	UR	UR	UR	UR	UR	-		
Model No.	1 pc(s).	9614.110	9614.100	9615.100	9614.000	9615.000	9625.000	9629.010		
Accessories										
Insert strip	2 pc(s).	9623.000	9623.000	9623.000	9623.000	9623.000	9623.000	9623.000	353	
Support rails, height 7.5 mm	Width 45 mm	10 pc(s).	9320.150	9320.150	9320.150	-	-	-	9320.150	352
	Width 54 mm	10 pc(s).	-	-	-	3548.000	3548.000	-	-	352

Mini-PLS component adaptors

Rated current max. 40 – 100 A

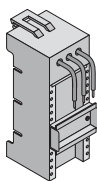
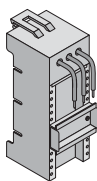
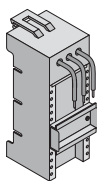
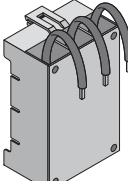
							
Rated max. current A	Packs of	40	40	40	100	Page	
Rated operating voltage V, ~		690, 3~	690, 3~	690, 3~	690, 3~		
Number of poles		3-pole	3-pole	3-pole	3-pole		
Connection cables		AWG 10	AWG 10	AWG 10	35 mm ²		
Support rails quantity/height mm		1/7.5	1/15	1/7.5	–		
Width mm		54	54	72	90		
Height mm		160	160	160	160		
Approvals		UR	UR	UR	UR		
Model No.	1 pc(s).	9616.000	9617.000	9627.000	9629.000		
Accessories							
Insert strip	2 pc(s).	9623.000	9623.000	9623.000	–	353	
Support rails	Height 7.5 mm	Width 54 mm	10 pc(s).	3548.000	3548.000	–	352
	Height 15 mm	Width 72 mm	5 pc(s).	–	–	–	9320.120

Power distribution

Switchgear assignment – Mini-PLS component adaptors 12 A/25 A

Make/model	Model No.
ABB	
MS116	9614.100
MS325	9614.000
MS450 (max. 25 A)	9614.000
MS451 (max. 25 A)	9614.000
Eaton	
PKZM0 (up to 25 A)	9614.100
PKZM01 (up to 25 A)	9614.100
PKZM4 (up to 25 A)	9614.000
PKE12	9614.100
PKE32 (up to 25 A)	9614.100
PKE65 (up to 25 A)	9614.000
Schneider Electric	
GV2-P (up to 25 A)	9614.100
GV2-RT	9614.100
GV2-LE10	9614.100
GV3 (up to 25 A)	9614.100

Make/model	Model No.
Siemens	
S0	
3RV10 21...	9614.100
3RV20 21... (up to 25 A)	9614.100
S00	
3RV10 11...	9614.100 ¹⁾
3RV20 11...	9614.100 ¹⁾
S2	
3RV10 31... (up to 25 A)	9614.000

¹⁾ Support rail must be offset

Switchgear assignment – Mini-PLS component adaptors 40 A/100 A

Make/model	Model No.	Accessories Model No.
ABB		
MS450 (max. 40 A)	9617.000	–
MS451 (max. 40 A)	9629.000	9320.120
MS495	9629.000	9320.120
MS496	9629.000	9320.120
MS497	9629.000	9320.120
Tmax		
T1	9629.000	–
T2	9629.000	–
Eaton		
NZM 1	9629.000	–
PKZ2	9627.000	–
PKZM4 (max. 40 A)	9617.000	–
PKZM4	9629.000	9320.120

Make/model	Model No.	Accessories Model No.
Schneider Electric		
NS 80	9629.000	–
GV3 (max. 40 A)	9616.000	–
GV3	9629.000	9320.120
Siemens		
S2		
3RV10 31... (max. 40 A)	9616.000	–
3RV10 31...	9629.000	9320.120
S3		
3RV1341/42	9629.000	9320.120

Rittal – The System.

Faster – better – everywhere.



RiLine

Busbar systems 3-/4-pole and DC

Support + bars + contact hazard protection

- Flat copper bar system, see page 300
- PLS busbar system, see page 302
- Accessories, see page 340



Connection system 3- and 4-pole

- Busbar connection adaptors, see page 304
- Connection clamps, see page 349
- Connection block, see page 351
- Accessories, see page 349



Component adaptors 3- and 4-pole

- OM adaptors, see page 307
- Circuit-breaker component adaptors, see page 314
- Accessories, see page 352



Fuse elements 3-pole

- Bus-mounting fuse bases, see page 323
- NH fuse-switch disconnectors, see page 325
- NH slimline fuse-switch disconnectors, see page 335
- Fuse holders, see page 337
- Accessories, see page 356



VX25 Power Engineering

see page 446

- Simple component selection, integral switchgear database
- Automatic calculation of rated currents and heat losses
- Configuration of RiLine busbar systems (offline version RPE 7.0)



RiLine busbar systems up to 800 A (60 mm)



Busbar connection adaptors Page 304 **OM adaptors** Page 307 **Circuit-breaker component adaptors** Page 314 **Fuse elements** Page 323

Material:

- Polyamide
- Fire protection corresponding to UL 94-V0





Colour:

- RAL 7035

Note:



- UL approval only valid in conjunction with AC applications
- The use of a base tray is required for UL applications.

Flat copper busbar system

Busbar supports							
Number of poles	Packs of		3-pole	3-pole	3-pole	4-pole	Page
Bar centre distance mm			60	60	60	60	
External attachment			■	-	-	-	
Internal attachment			-	■	■	■	
For busbars mm	12 x 5/10		■	■	-	■	
	15 x 5 – 30 x 10		■	■	■	■	
Rated operating voltage V, ~			1000, 3~	1000, 3~	1000, 3~	1000, 3~	
			-	-	1500 (DC)	-	
Approvals			-	-	UL	UL	
Model No.	4 pc(s).		9340.010	9340.000	9340.050	9340.004	
Also required							
Spacers when using busbars 12 x 5/10 mm			■	■	-	■	
Model No.	12 pc(s).		9340.090	9340.090	-	9340.090	341

RiLine busbar systems up to 800 A (60 mm)

Flat copper busbar system

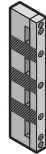
Busbar supports						
						
Number of poles	Packs of	3-pole	3-pole	3-pole	4-pole	Page
Bar centre distance mm		60	60	60	60	
Model No.	4 pc(s).	9340.010	9340.000	9340.050	9340.004	300
Also required						
Spacer when using busbars 12 x 5/10 mm		■	■	–	■	
Model No.	12 pc(s).	9340.090	9340.090	–	9340.090	341

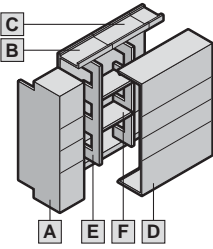
Contact hazard protection									
	Components	Length mm	Approvals	Packs of	Model No.			Model No.	Page
	A End covers	–	UL	2 pc(s).	9340.070	9340.070	9340.070	9340.074	–
	B Base trays	500	UL	2 pc(s).	–	9340.100	9340.100	–	347
		700	UL	2 pc(s).	–	9340.110	9340.110	–	347
		900	UL	2 pc(s).	–	9340.120	9340.120	–	347
		1100	UL	2 pc(s).	–	9340.130	9340.130	9340.134	347
		2400	UL	1 pc(s).	–	9340.170	9340.170	–	347
	C Base tray infills	100	UL	2 pc(s).	–	9340.140	9340.140	–	347
D Cover sections	700	UL	2 pc(s).	–	9340.200	9340.200	–	348	
	1100	UL	2 pc(s).	–	9340.210	9340.210	9340.214	348	
E Support panels	–	UL	5 pc(s).	–	9340.220	9340.220	9340.224	348	
F Cross members	160	UL	2 pc(s).	–	–	9340.230	–	348	

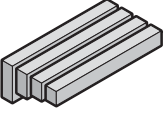
Busbars E-Cu, length: 2400 mm/bar										
	Dimensions mm	Max. rated current A according to		Approvals	Packs of	Model No.			Model No.	Page
		DIN ¹⁾	UL 508							
	12 x 5	210	160	UL	6 pc(s).	3580.000	3580.000	3580.000	3580.000	342
	12 x 10	340	320	UL	6 pc(s).	3580.100	3580.100	3580.100	3580.100	342
	15 x 5	260	200	UL	6 pc(s).	3581.000	3581.000	3581.000	3581.000	342
	15 x 10	360	400	UL	6 pc(s).	3581.100	3581.100	3581.100	3581.100	342
	20 x 5	274	270	UL	6 pc(s).	3582.000	3582.000	3582.000	3582.000	342
	20 x 10	427	540	UL	3 pc(s).	3585.005	3585.005	3585.005	3585.005	342
	25 x 5	327	330	UL	6 pc(s).	3583.000	3583.000	3583.000	3583.000	342
30 x 5	379	400	UL	6 pc(s).	3584.000	3584.000	3584.000	3584.000	342	
30 x 10	573	810	UL	3 pc(s).	3586.005	3586.005	3586.005	3586.005	342	

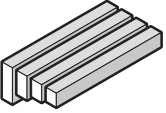
CUPONAL busbars, length: 2400 mm/bar										
	Dimensions mm	Max. rated current A according to		Approvals	Packs of	Model No.			Model No.	Page
		DIN ¹⁾	UL 508							
	20 x 5	235	–	–	6 pc(s).	–	3582.020	3582.020	–	342
	20 x 10	363	–	–	3 pc(s).	–	3585.020	3585.020	–	342
	30 x 5	328	–	–	6 pc(s).	–	3584.020	3584.020	–	342
30 x 10	493	–	–	3 pc(s).	–	3586.020	3586.020	–	342	

Accessories								
Components	For busbars mm	Approvals	Packs of	Model No.			Model No.	Page
Busbar connectors for single connection	12 x 5 – 15 x 10	UL	3 pc(s).	9350.075	9350.075	9350.075	9350.075	343
	20 x 5 – 30 x 10	UL	3 pc(s).	9320.020	9320.020	9320.020	9320.020	343
Busbar connectors for baying connection ²⁾	20 x 5 – 30 x 10	UL	3 pc(s).	9320.030	9320.030	9320.030	9320.030	343
Busbar cover sections Length: 1000 mm/section	12 x 5 – 30 x 10	UR	10 pc(s).	3092.000	3092.000	3092.000	3092.000	343
	12/15 x 5	UR	4 pc(s).	9350.010	9350.010	9350.010	9350.010	343
	12/15 x 10	UR	4 pc(s).	9350.060	9350.060	9350.060	9350.060	343

¹⁾ Maximum rated value of an exposed, uncovered busbar at a temperature increase of 30 K to DIN 43 671

²⁾ Connection from enclosure to enclosure

RiLine busbar systems 800 A/1600 A (60 mm)

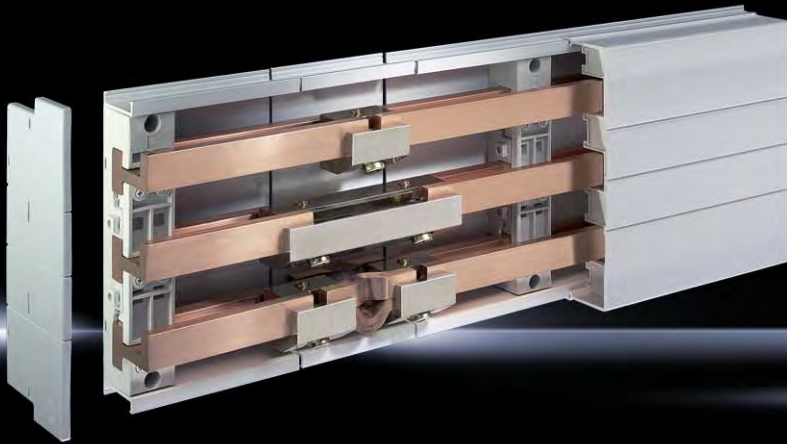

Busbar connection adaptors Page 304 **OM adaptors** Page 307 **Circuit-breaker component adaptors** Page 314 **Fuse elements** Page 323

Material:

- Polyamide
- Fire protection corresponding to UL 94-V0

Colour:

- RAL 7035

Note:





- UL approval only valid in conjunction with AC applications
- The use of a base tray is required for UL applications.

PLS busbar system

Busbar supports						
		PLS 800		PLS 1600		
For Rittal system	Packs of	3-pole	3-pole	3-pole	3-pole	4-pole
Number of poles		3-pole	3-pole	3-pole	3-pole	4-pole
Bar centre distance mm		60	60	60	60	60
Internal attachment		■	■	■	■	■
Busbar support, suitable for top mounting		■	■	■	■	-
Rated operating voltage V, ~		1000, 3~	1000, 3~	1000, 3~	1000, 3~	1000, 3~
		-	1500 (DC)	-	1500 (DC)	-
Approvals		-	UL	-	UL	UL
Model No.	4 pc(s).	9341.000	9341.050	9342.000	9342.050	9342.004

RiLine busbar systems 800 A/1600 A (60 mm)

PLS busbar system

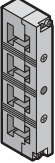
Busbar supports							
							 PLS 1600 PLUS
For Rittal system	Packs of	PLS 800		PLS 1600			Page
Number of poles		3-pole	3-pole	3-pole	3-pole	4-pole	
Bar centre distance mm		60	60	60	60	60	
Model No.	4 pc(s).	9341.000	9341.050	9342.000	9342.050	9342.004	302

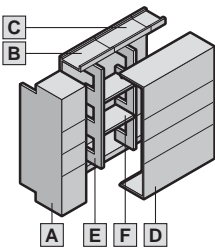
Contact hazard protection										
	Components	Length mm	Approvals	Packs of	Model No.		Model No.			Page
	A End covers	–	UL	2 pc(s).	9341.070	9341.070	9342.070	9342.070	9342.074	–
	B Base trays	500	UL	2 pc(s).	9341.100	9341.100	9342.100	9342.100	–	347
		700	UL	2 pc(s).	9341.110	9341.110	9342.110	9342.110	–	347
		900	UL	2 pc(s).	9341.120	9341.120	9342.120	9342.120	–	347
		1100	UL	2 pc(s).	9341.130	9341.130	9342.130	9342.130	9342.134	347
		2400	UL	1 pc(s).	9341.170	–	9342.170	–	–	347
	C Base tray infills	100	UL	2 pc(s).	9341.140	9341.140	9342.140	9342.140	–	347
D Cover sections	700	UL	2 pc(s).	9340.200	9340.200	9340.200	9340.200	–	348	
	1100	UL	2 pc(s).	9340.210	9340.210	9340.210	9340.210	9340.214	348	
E Support panels	–	UL	5 pc(s).	9340.220	9340.220	9340.220	9340.220	9340.224	348	
F Cross members	160	UL	2 pc(s).	–	9340.230	–	9340.230	–	348	

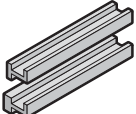
PLS special busbars E-Cu											
	Version			Packs of	PLS 800		PLS 1600			Page	
	Bar cross-section mm ²				300		900				
	Bar thickness mm				5		10				
	Max. rated current A acc. to	DIN ¹⁾				684		1368			
		UL 508				890		1500			
	Length mm	For enclosure width mm	Approvals			Model No.		Model No.			
	495	600	UL	3 pc(s).		3524.000		3527.000			344
	695	800	UL	3 pc(s).		3525.000		3528.000			344
895	1000	UL	3 pc(s).		3525.010		3528.010			344	
1095	1200	UL	3 pc(s).		3526.000		3529.000			344	
2400	variable	UL	1 pc(s).		3509.000		3516.000			344	

Accessories										
Components		Approvals	Packs of		Model No.		Model No.			Page
PLS busbar connectors	Single connection	UL	3 pc(s).		3504.000		3514.000			344
	Bayed connection ²⁾	UL	3 pc(s).		3505.000		3515.000			344
PLS expansion connector ³⁾		UR	3 pc(s).		9320.060		9320.070			345

¹⁾ Maximum rated value of an exposed, uncovered busbar at a temperature increase of 30 K to DIN 43 671

²⁾ Connection from enclosure to enclosure

³⁾ 2 PLS busbar connectors (single connection) are required to fit one expansion connector

Connection adaptors



Busbar system Page 300 **OM adaptors** Page 307 **Circuit-breaker component adaptors** Page 314 **Fuse elements** Page 323

Material:

- Cover: ABS
- Punched section: Polyamide
- Chassis 3439.010: Fibreglass-reinforced, thermoplastic polyester (PBT)
- Fire protection corresponding to UL 94-V0





Colour:

- RAL 7035

Note:

- The technical data may vary for UL applications
- UL approval only applies in conjunction with AC application
- The rated operating voltage for DC applications depends on the busbar arrangement in the busbar supports 9340.050/9341.050/9342.050.

Rated current max. 63 – 125 A

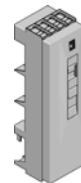

							
Rated current max. A	Packs of	63	63	125	125	125	Page
Rated operating voltage V, ~		690, 3~	690, 3~	690, 3~	690, 3~	690, 4~	
Rated operating voltage (L1 + L2) V		-	1000 (DC)	-	1000 (DC)	-	
Rated operating voltage (L1 + L3) V		-	1500 (DC)	-	1500 (DC)	-	
Number of poles		3-pole	3-pole	3-pole	3-pole	4-pole	
Cable outlet		Top	Bottom	Top/bottom	Bottom	Top/bottom	
Connection of round conductors, fine wire with wire end ferrule mm ²		2.5 - 10	2.5 - 10	10 - 25	10 - 25	10 - 25	
Connection of round conductors, multi-wire mm ²		2.5 - 10	2.5 - 10	16 - 35	16 - 35	16 - 35	
Connection of round conductors, single-wire mm ²		2.5 - 10	2.5 - 10	-	-	-	
Clamping area for laminated copper bars (W x H) mm		-	-	10 x 7.8	10 x 7.8	10 x 7.8	
Clamping area for laminated copper bars with 5 mm bar thickness (W x H)		-	-	-	-	-	
Clamping area for laminated copper bars with 10 mm bar thickness (W x H)		-	-	-	-	-	
Width mm		20	20	55	55	75	
Height mm		215	215	210	210	270	
Approvals		UL	UL	UR	UL	UL	
For bar systems with centre-to-centre spacing mm		60	60	60	60	60	
For bar thickness mm		5/10	5/10	5/10	5/10	5/10	
Model No.	1 pc(s).	9342.200	9342.210	9342.220	9342.240	9342.224	
Accessories							
Laminated copper bar		-	-	see page	see page	see page	346
Connection adaptor expansion set		-	-	-	-	-	

Connection adaptors

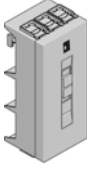
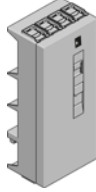
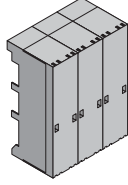
Rated current max. 250 – 600 A

						
Rated current max. A	Packs of	250	250	250	600	Page
Rated operating voltage V, ~		690, 3~	690, 3~	690, 4~	690, 3~	
Rated operating voltage (L1 + L2) V		–	1000 (DC)	–	–	
Rated operating voltage (L1 + L3) V		–	1500 (DC)	–	–	
Number of poles		3-pole	3-pole	4-pole	3-pole	
Cable outlet		Top/bottom	Bottom	Top/bottom	Top/bottom	
Connection of round conductors, fine wire with wire end ferrule mm ²		35 - 120	35 - 120	35 - 120	35 - 240	
Connection of round conductors, multi-wire mm ²		35 - 120	35 - 120	35 - 120	35 - 240	
Connection of round conductors, single-wire		–	–	–	–	
Clamping area for laminated copper bars (W x H) mm		18,5 x 15,5	18,5 x 15,5	18,5 x 15,5	24 x 21	
Clamping area for laminated copper bars with 5 mm bar thickness (W x H)		–	–	–	–	
Clamping area for laminated copper bars with 10 mm bar thickness (W x H)		–	–	–	–	
Width mm		90	90	118	180	
Height mm		210	210	270	247	
Approvals		UL	UL	UL	–	
For bar systems with centre-to-centre spacing mm		60	60	60	60	
For bar thickness mm		5/10	5/10	5/10	5/10	
Model No.	1 pc(s).	9342.250	9342.270	9342.254	3439.010	
Accessories						
Laminated copper bar		see page	see page	see page	see page	346
Connection adaptor expansion set		–	–	–	–	

Rated current max. 800 – 1600 A

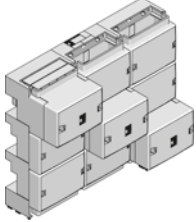
						
Rated current max. A	Packs of	800	800	800	1600	Page
Rated operating voltage V, ~		690, 3~	690, 3~	690, 3~	690, 3~	
Rated operating voltage (L1 + L2) V		–	1000 (DC)	1000 (DC)	1000 (DC)	
Rated operating voltage (L1 + L3) V		–	1500 (DC)	1500 (DC)	1500 (DC)	
Number of poles		3-pole	3-pole	3-pole	3-pole	
Cable outlet		Top/bottom	Top/bottom	Bottom	Top/bottom	
Connection of round conductors, fine wire with wire end ferrule mm ²		95 - 185	95 - 185	95 - 185	–	
Connection of round conductors, multi-wire mm ²		95 - 300	95 - 300	95 - 300	–	
Connection of round conductors, single-wire		–	–	–	–	
Clamping area for laminated copper bars (W x H) mm		33 x 20	–	33 x 20	–	
Clamping area for laminated copper bars with 5 mm bar thickness (W x H) mm		–	33 x 26	–	65 x 27	
Clamping area for laminated copper bars with 10 mm bar thickness (W x H) mm		–	33 x 21	–	65 x 22	
Width mm		129	150	129	255	
Height mm		246	210	246	210	
Approvals		UR	UL	UL	UL	
For bar systems with centre-to-centre spacing mm		60	60	60	60	
For bar thickness mm		5/10	5/10	5/10	5/10	
Model No.	1 pc(s).	9342.280	9342.310	9342.300	9342.320	
Accessories						
Laminated copper bar		see page	see page	see page	see page	346
Connection adaptor expansion set	1 pc(s).	–	9342.314	–	9342.324	306

Connection adaptor expansion set



Busbar system Page 300 **OM adaptors** Page 307 **Circuit-breaker component adaptors** Page 314 **Fuse elements** Page 323

Single-pole extra set to complement the 3-pole connection adaptor for 4-pole configurations.

Material:

- Cover: ABS
- Punched section: Polyamide
- Fire protection corresponding to UL 94-V0

Colour:

- RAL 7035

Note:

- The technical data may vary for UL applications
- UL approval only applies in conjunction with AC application

for 4-pole configuration

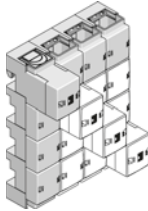
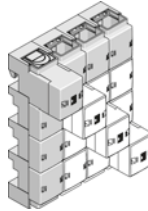
				
To fit Model No.	Packs of	9342.310	9342.320	Page
Rated current max. A		800	1600	
Rated operating voltage V, ~		690, 1~	690, 1~	
Number of poles		Single-pole	Single-pole	
Connection of round conductors, fine wire with wire end ferrule mm ²		95 - 185	-	
Connection of round conductors, multi-wire mm ²		95 - 300	-	
Clamping area for laminated copper bars with 5 mm bar thickness (W x H) mm		33 x 26	65 x 27	
Clamping area for laminated copper bars with 10 mm bar thickness (W x H) mm		33 x 21	65 x 22	
Width mm		50	85	
Height mm		270	270	
Approvals		UL	UL	
For bar systems with centre-to-centre spacing mm		60	60	
For bar thickness mm		5/10	5/10	
Model No.	1 pc(s).	9342.314	9342.324	
Accessories				
Laminated copper bar		see page	see page	346



Busbar system Page 300 **Connection adaptors** Page 304 **Fuse elements** Page 323 **Allocation of switchgear** Page 319

Material:

- Polyamide
- Fire protection corresponding to UL 94-V0

Colour:

- Chassis: RAL 7035

Note:

- The technical data may vary for UL applications

Rated current max. 16 A, with connection cables

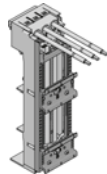
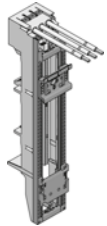
				
Rated current max. A	Packs of	16	16	Page
Rated operating voltage V, ~		690, 3~	690, 3~	
Number of poles		3-pole	3-pole	
Connection cables, Design		AWG 12	AWG 12	
Connection cables, Length mm		165	165	
With support frame mm		45 x 170	45 x 237	
With support frame support		-	■	
With PinBlock		-	■	
With insert strips		-	-	
Support rails Qty/height mm		2 / 10	1 / 10	
Support rail version		TS 45D TS 45D-V	TS 45D	
Width mm		45	45	
Height mm		208	272	
Approvals		UL	UL	
For bar systems with centre-to-centre spacing mm		60	60	
For bar thickness mm		5/10	5/10	
Model No.	1 pc(s).	9340.780	9340.760	
Accessories				
Support rail 35 x 10 mm		see page	see page	352
Insert strip	2 pc(s).	9340.290	9340.290	353
Connection pin	20 pc(s).	9340.280	9340.280	354
PinBlock	5 pc(s).	9342.800	-	354
OM supports		see page	see page	313

OM adaptors

Rated current max. 25 A, with connection cables

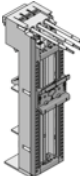
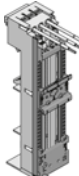
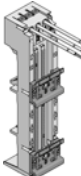
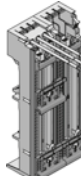
							
Rated current max. A	Packs of	25	25	25	25	25	Page
Rated operating voltage V, ~		690, 3~	690, 3~	690, 3~	690, 3~	690, 3~	
Number of poles		3-pole	3-pole	3-pole	3-pole	3-pole	
Connection cables, Design		AWG 12	AWG 12	AWG 12	AWG 12	AWG 12	
Connection cables, Length mm		130	130	130	130	130	
With support frame mm		–	45 x 170	45 x 170	–	45 x 170	
With support frame support		–	–	–	–	–	
With PinBlock		–	–	■	–	–	
With insert strips		–	–	–	–	–	
Support rails Qty/height mm		1 / 10	1 / 10	1 / 10	2 / 10	3 / 10	
Support rail version		TS 45C	TS 45C	TS 45C	TS 45D	TS 45D TS 45D-V	
Width mm		45	45	45	45	90	
Height mm		208	208	208	208	208	
Approvals		–	–	–	–	–	
For bar systems with centre-to-centre spacing mm		60	60	60	60	60	
For bar thickness mm		5/10	5/10	5/10	5/10	5/10	
Model No.	1 pc(s).	9340.310	9340.340	9340.370	9340.320	9340.400	
Accessories							
Support rail 35 x 10 mm		see page	see page	see page	see page	see page	352
Insert strip	2 pc(s).	9340.290	9340.290	9340.290	9340.290	–	353
Connection pin	20 pc(s).	9340.280	9340.280	9340.280	9340.280	–	354
PinBlock	5 pc(s).	–	9342.800	–	–	9342.800	354
OM supports		see page	see page	see page	see page	–	313

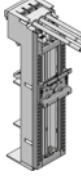
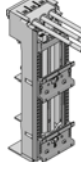
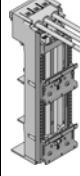
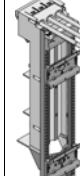
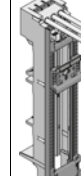
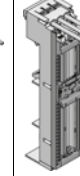
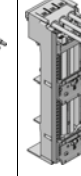

Rated current max. 32 A, with connection cables

									
Rated current max. A	Packs of	32	32	32	32	32	32	32	Page
Rated operating voltage V, ~		690, 3~	690, 3~	690, 3~	690, 3~	690, 3~	690, 3~	690, 3~	
Number of poles		3-pole	3-pole	3-pole	3-pole	3-pole	3-pole	3-pole	
Connection cables, Design		AWG 10	AWG 10	AWG 10	AWG 10	AWG 10	AWG 10	AWG 10	
Connection cables, Length mm		130	130	165	130	165	130	130	
With support frame mm		45 x 170	45 x 170	45 x 170	45 x 237	45 x 237	55 x 170	55 x 170	
With support frame support		–	–	–	■	■	–	–	
With PinBlock		–	–	–	–	■	–	–	
With insert strips		–	–	–	–	–	–	–	
Support rails Qty/height mm		1 / 10	2 / 10	2 / 10	2 / 10	1 / 10	1 / 10	2 / 10	
Support rail version		TS 45C	TS 45D TS 45D-V	TS 45D TS 45D-V	TS 45D TS 45D-V	TS 45D	TS 55D	TS 55D TS 55D-V	
Width mm		45	45	45	45	45	55	55	
Height mm		208	208	208	272	272	208	208	
Approvals		–	–	–	–	–	–	–	
For bar systems with centre-to-centre spacing mm		60	60	60	60	60	60	60	
For bar thickness mm		5/10	5/10	5/10	5/10	5/10	5/10	5/10	
Model No.	1 pc(s).	9340.350	9340.380	9340.790	9340.390	9340.770	9340.460	9340.470	
Accessories									
Support rail 35 x 10 mm		see page	see page	see page	see page	see page	see page	see page	352
Insert strip	2 pc(s).	9340.290	9340.290	9340.290	9340.290	9340.290	9340.290	9340.290	353
Connection pin	20 pc(s).	9340.280	9340.280	9340.280	9340.280	9340.280	9340.280	9340.280	354
PinBlock	5 pc(s).	9342.800	9342.800	9342.800	9342.800	9342.800	9342.810	9342.810	354
OM supports		see page	see page	see page	see page	see page	see page	see page	313

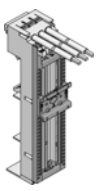
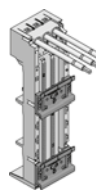
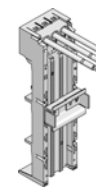
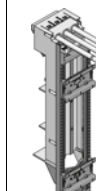
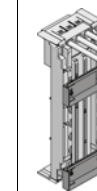
Rated current max. 40 A, with connection cables

							
Rated current max. A	Packs of	40	40	40	40	40	Page
Rated operating voltage V, ~		690, 3~	690, 3~	690, 3~	690, 3~	690, 3~	
Number of poles		3-pole	3-pole	3-pole	3-pole	3-pole	
Connection cables, Design		AWG 8	AWG 8	AWG 8	AWG 8	AWG 8	
Connection cables, Length mm		130	130	130	130	130	
With support frame mm		55 x 170	–	–	55 x 237	–	
With support frame support		–	–	–	■	–	
With PinBlock		–	–	–	–	–	
With insert strips		–	–	–	–	■	
Support rails Qty/height mm		1 / 10	2 / 10	1 / 15	2 / 10	2 / 7.5	
Support rail version		TS 55D	TS 55D	Metal	TS 55D TS 55D-V	Metal	
Width mm		55	55	55	55	75	
Height mm		208	208	208	272	208	
Approvals		–	–	–	–	–	
For bar systems with centre-to-centre spacing mm		60	60	60	60	60	
For bar thickness mm		5/10	5/10	5/10	5/10	5/10	
Model No.	1 pc(s).	9340.720	9340.740	9340.750	9340.730	9340.710	
Accessories							
Support rail 35 x 10 mm		see page	see page	see page	see page	–	352
Insert strip	2 pc(s).	9340.290	9340.290	9340.290	9340.290	–	353
Connection pin	20 pc(s).	9340.280	9340.280	9340.280	9340.280	9340.280	354
PinBlock	5 pc(s).	9342.810	–	–	9342.810	–	354
OM supports		see page	see page	see page	see page	see page	313

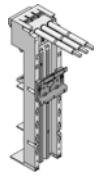
Rated current max. 65 A, with connection cables

							
Rated current max. A	Packs of	65	65	65	65	Page	
Rated operating voltage V, ~		690, 3~	690, 3~	690, 3~	690, 3~		
Number of poles		3-pole	3-pole	3-pole	3-pole		
Connection cables, Design		AWG 6	AWG 6	AWG 6	AWG 6		
Connection cables, Length mm		130	130	130	130		
With support frame mm		–	55 x 170	55 x 237	–		
With support frame support		–	–	■	–		
With PinBlock		–	–	–	–		
With insert strips		–	–	–	■		
Support rails Qty/height mm		1 / 10	1 / 10	2 / 10	1 / 7.5		
Support rail version		TS 55E	TS 55E	TS 55E TS 55D-V	Metal		
Width mm		55	55	55	75		
Height mm		208	208	272	208		
Approvals		–	–	–	–		
For bar systems with centre-to-centre spacing mm		60	60	60	60		
For bar thickness mm		5/10	5/10	5/10	5/10		
Model No.	1 pc(s).	9340.410	9340.430	9340.450	9340.700		
Accessories							
Support rail 35 x 10 mm		see page	see page	see page	–	352	
Insert strip	2 pc(s).	9340.290	9340.290	9340.290	–	353	
Connection pin	20 pc(s).	9340.280	9340.280	9340.280	–	354	
PinBlock	5 pc(s).	–	9342.810	9342.810	–	354	
OM supports		see page	see page	see page	see page	313	

OM adaptors



Busbar system Page 300 **Connection adaptors** Page 304 **Fuse elements** Page 323 **Allocation of switchgear** Page 319







Material:

- Polyamide
- Fire protection corresponding to UL 94-V0





Colour:

- Chassis: RAL 7035

Rated current max. 32 A, with spring terminals

								
Rated current max. A	Packs of	32	32	32	32	32	32	Page
Rated operating voltage V, ~		690, 3~	690, 3~	690, 3~	690, 3~	690, 3~	690, 3~	
Number of poles		3-pole	3-pole	3-pole	3-pole	3-pole	3-pole	
Connection of round conductors mm ²		1.5 - 6	1.5 - 6	1.5 - 6	1.5 - 6	1.5 - 6	1.5 - 6	
With support frame mm		-	-	45 x 170	45 x 170	45 x 237	55 x 170	
With support frame support		-	-	-	-	■	-	
With PinBlock		-	-	-	■	-	-	
Support rails Qty/height mm		1 / 10	2 / 10	1 / 10	1 / 10	2 / 10	1 / 10	
Support rail version		TS 45C	TS 45D	TS 45C	TS 45C	TS 45D TS 45D-V	TS 55D	
Width mm		45	45	45	45	45	55	
Height mm		208	208	208	208	272	208	
For bar systems with centre-to-centre spacing mm		60	60	60	60	60	60	
For bar thickness mm		5/10	5/10	5/10	5/10	5/10	5/10	
Model No.	1 pc(s).	9340.510	9340.520	9340.530	9340.550	9340.560	9340.660	
Accessories								
Support rail 35 x 10 mm		see page	see page	see page	see page	see page	see page	352
Insert strip	2 pc(s).	9340.290	9340.290	9340.290	9340.290	9340.290	9340.290	353
Connection pin	20 pc(s).	9340.280	9340.280	9340.280	9340.280	9340.280	9340.280	354
PinBlock	5 pc(s).	-	-	9342.800	9342.800	9342.800	9342.810	354
Cable set		see page	see page	see page	see page	see page	see page	354
Twin cord		-	-	-	-	-	-	
OM supports		see page	see page	see page	see page	see page	see page	313

Rated current max. 65 A, with spring terminals

						
Rated current max. A	Packs of	65	65	65	65	Page
Rated operating voltage V, ~		690, 3~	690, 3~	690, 3~	690, 3~	
Number of poles		3-pole	3-pole	3-pole	3-pole	
Connection of round conductors mm ²		2.5 - 16	2.5 - 16	2.5 - 16	2.5 - 16	
According to a heat dissipation test to IEC 61 439-1, a current carrying capacity of up to 80 A is supported		■	■	■	■	
With support frame mm		-	-	55 x 170	55 x 237	
With support frame support		-	-	-	■	
With PinBlock		-	-	-	-	
Support rails Qty/height mm		1 / 10	2 / 10	1 / 10	2 / 10	
Support rail version		TS 55E	TS 55E TS 55D	TS 55E	TS 55E TS 55D-V	
Width mm		55	55	55	55	
Height mm		208	208	208	272	
For bar systems with centre-to-centre spacing mm		60	60	60	60	
For bar thickness mm		5/10	5/10	5/10	5/10	
Model No.	1 pc(s).	9340.610	9340.620	9340.630	9340.650	
Accessories						
Support rail 35 x 10 mm		see page	see page	see page	see page	352
Insert strip	2 pc(s).	9340.290	9340.290	9340.290	9340.290	353
Connection pin	20 pc(s).	9340.280	9340.280	9340.280	9340.280	354
PinBlock	5 pc(s).	-	-	9342.810	9342.810	354
Cable set		see page	see page	see page	see page	354
Twin cord		see page	see page	see page	see page	355
OM supports		see page	see page	see page	see page	313

Rittal – The System.

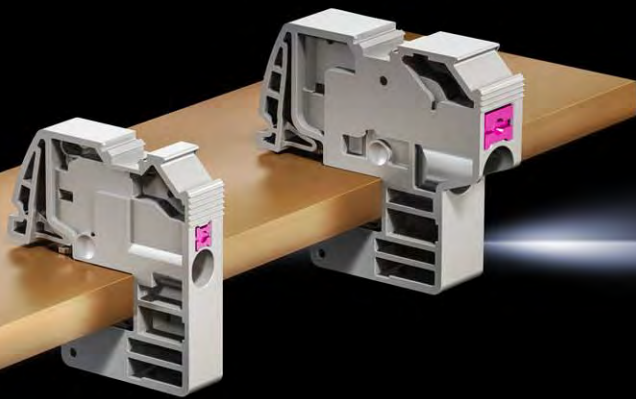

Conductor connection clamps

see page 349

OM adaptors



Busbar system Page 300 **Connection adaptors** Page 304 **Fuse elements** Page 323

Material:

- Polyamide
- Fire protection corresponding to UL 94-V0

Colour:

- Chassis: RAL 7035

Rated current max. 25 A, with plug-in cable outlet

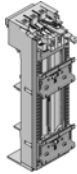
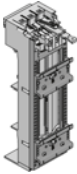
				
Rated current max. A	Packs of	25	25	Page
Rated operating voltage V, ~		690, 3~	690, 3~	
Number of poles		3-pole	3-pole	
Connection of round conductors mm ²		1.5 - 4	1.5 - 4	
With support frame mm		45 x 170	55 x 170	
Support rails Qty/height mm		2 / 10	2 / 10	
Support rail version		TS 45D TS 45D-V	TS 55D TS 55D-V	
Width mm		45	55	
Height mm		208	208	
For bar systems with centre-to-centre spacing mm		60	60	
For bar thickness mm		5/10	5/10	
Model No.	1 pc(s).	9340.910	9340.930	
Product-specific scope of supply				
Connector with connection facility for 3 main contacts (1.5 - 4 mm ²)		■	■	
Accessories				
Support rail 35 x 10 mm		see page	see page	352
Cable set		see page	see page	354





Busbar system Page 300 **Connection adaptors** Page 304 **Fuse elements** Page 323

For mounting of switchgear with external power supply.

- Material:**
- Polyamide
 - Fire protection corresponding to UL 94-V0
- Colour:**
- Chassis: RAL 7035

without contact system

					
Number of poles	Packs of	-	-	-	Page
With support frame mm		45 x 170	55 x 237	-	
With support frame support		-	■	-	
With PinBlock		■	-	-	
Support rails Qty/height mm		-	1 / 10	2 / 10	
Support rail version		-	TS 55D-V	TS 45D	
Width mm		45	55	45	
Height mm		208	272	208	
Approvals		UL	UL	UL	
For bar systems with centre-to-centre spacing mm		60	60	60	
For bar thickness mm		5/10	5/10	5/10	
Model No.	1 pc(s).	9340.260	9340.270	9340.300	
Accessories					
Support rail 35 x 10 mm		see page	see page	see page	352
Insert strip	2 pc(s).	9340.290	9340.290	9340.290	353
Connection pin	20 pc(s).	9340.280	9340.280	9340.280	354

Circuit-breaker component adaptors



Busbar system Page 300 **Connection adaptors** Page 304 **Fuse elements** Page 323

Material:

- Polyamide
- Fire protection corresponding to UL 94-V0

Colour:

- RAL 7035

Note:

- Cable outlet: Switch outlet or as outgoing cable from the switchgear

- The technical data may vary for UL applications

Rated current max. 100 – 125 A, 3-pole

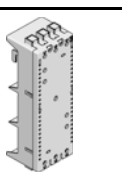
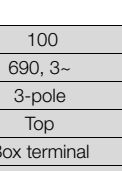
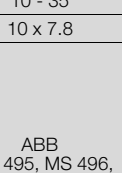
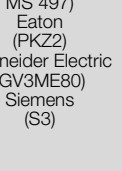
						
Rated current max. A	Packs of	100	100	125	125	Page
Rated operating voltage V, ~		690, 3~	690, 3~	690, 3~	690, 3~	
Number of poles		3-pole	3-pole	3-pole	3-pole	
Cable outlet		Top	Bottom	Top	Bottom	
Type of connection		Box terminal	Box terminal	Box terminal	Box terminal	
Connection of round conductors mm ²		10 - 35	10 - 35	35 - 120	35 - 120	
Clamping area for laminated copper bars (W x H) mm		10 x 7.8	10 x 7.8	18.5 x 15.5	18.5 x 15.5	
For switchgear make (model)		ABB (MS 495, MS 496, MS 497) Eaton (PKZ2) Schneider Electric (GV3ME80) Siemens (S3)	ABB (MS 495, MS 496, MS 497) Eaton (PKZ2) Schneider Electric (GV3ME80) Siemens (S3)	ABB (S1, S2, T1, T1 UL, T2, T2 UL, XT1, XT2) Allen Bradley (140-CMN) Eaton (NZM1, NZM1 UL, BZM B1) GE (FD160) OEZ (BC160N) Schneider Electric (NS80, NSC100, NSE75, NSE100) Schrack (MC1) Siemens (3RV13 53, 3VT1, 3VA10, 3VA11, 3VA51) Terasaki (E125, S125)	ABB (S1, S2, T1, T1 UL, T2, T2 UL, XT1, XT2) Allen Bradley (140-CMN) Eaton (NZM1, NZM1 UL, BZM B1) GE (FD160) OEZ (BC160N) Schneider Electric (NS80, NSC100, NSE75, NSE100) Schrack (MC1) Siemens (3RV13 53, 3VT1, 3VA10, 3VA11, 3VA51) Terasaki (E125, S125)	
Width mm		72	72	90	90	
Height mm		210	210	225	225	
Approvals		UL	UL	UL	UL	
For bar systems with centre-to-centre spacing mm		60	60	60	60	
For bar thickness mm		5/10	5/10	5/10	5/10	
Model No.	1 pc(s).	9342.400	9342.410	9342.540	9342.550	
Product-specific scope of supply						
Terminal cover		-	-	■	■	
Sliding blocks		-	-	■	■	
Accessories						
Support rail 35 x 15 mm	5 pc(s).	9320.120	9320.120	-	-	353
Connection bracket	3 pc(s).	-	-	9342.570	9342.570	355
Insert strip		-	-	-	-	

Circuit-breaker component adaptors

Rated current max. 160 – 250 A, 3-pole

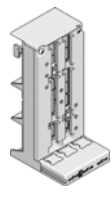
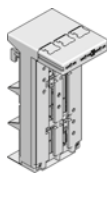
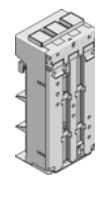
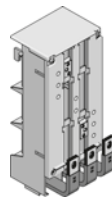
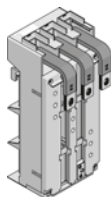
							
Rated current max. A	Packs of	160	160	250	250	250	Page
Rated operating voltage V, ~		690, 3~	690, 3~	690, 3~	690, 3~	690, 3~	
Number of poles		3-pole	3-pole	3-pole	3-pole	3-pole	
Cable outlet		Top	Bottom	Bottom	Top	Bottom	
Type of connection		Box terminal	Box terminal	Box terminal	–	–	
Connection of round conductors mm ²		35 - 120	35 - 120	35 - 120	–	–	
Clamping area for laminated copper bars (W x H) mm		18.5 x 15.5	18.5 x 15.5	18.5 x 15.5	–	–	
For switchgear make (model)		ABB (S1, S2, T1, T2, XT1, XT2) Allen Bradley (140-CMN) Eaton (NZM1, BZM B1) GE (FD160) Legrand (DPX 125, DPX 160) OEZ (BC160N) Schneider Electric (NS80, NSC100) Schrack (MC1) Siemens (3RV13 53, 3VT1, 3VA10, 3VA11) Terasaki (E125, S125)	ABB (S1, S2, T1, T2, XT1, XT2) Allen Bradley (140-CMN) Eaton (NZM1, BZM B1) GE (FD160) Legrand (DPX 125, DPX 160) OEZ (BC160N) Schneider Electric (NS80, NSC100) Schrack (MC1) Siemens (3RV13 53, 3VT1, 3VA10, 3VA11) Terasaki (E125, S125)	ABB (S3, T3, T4/320 A, T3 UL, T4 UL, XT3, XT4) Allen Bradley (140U-J) Eaton (NZM2, NZM2 UL, BZM B2) GE (FE160, FE250, FD160) Legrand (DPX 250) Mitsubishi (NF125-SGW/HGW, NF160-SGW/HGW) OEZ (BD250N, BD250S) Schneider Electric (NS(X)100, NS(X)160, NS(X)250, GV7, NSF150, NSF250) Schrack (MC2) Siemens (VL150(X) UL, VL160(X), VL250, VL250 UL, 3RV10 63, 3RV13 63, 3RV13 64, 3VT2, 3VA12/20/21/22, 3VA52/61/62) Terasaki (H125, L125, H160, L160, S160, E250, H250, L250)	ABB (S3, T3, T4/320 A, T3 UL, T4 UL, XT3, XT4) Allen Bradley (140U-J) Eaton (NZM2, NZM2 UL, BZM B2) GE (FE160, FE250, FD160) Legrand (DPX 250) Mitsubishi (NF125-SGW/HGW, NF160-SGW/HGW) OEZ (BD250N, BD250S) Schneider Electric (NS(X)100, NS(X)160, NS(X)250, GV7, NSF150, NSF250) Schrack (MC2) Siemens (VL150(X) UL, VL160(X), VL250, VL250 UL, 3RV10 63, 3RV13 63, 3RV13 64, 3VT2, 3VA12/20/21/22, 3VA52/61/62) Terasaki (H125, L125, H160, L160, S160, E250, H250, L250)	ABB (S3, T3, T4/320 A, T3 UL, T4 UL, XT3, XT4) Allen Bradley (140U-J) Eaton (NZM2, NZM2 UL, BZM B2) GE (FE160, FE250, FD160) Legrand (DPX 250) Mitsubishi (NF125-SGW/HGW, NF160-SGW/HGW) OEZ (BD250N, BD250S) Schneider Electric (NS(X)100, NS(X)160, NS(X)250, GV7, NSF150, NSF250) Schrack (MC2) Siemens (VL150(X) UL, VL160(X), VL250, VL250 UL, 3RV10 63, 3RV13 63, 3RV13 64, 3VT2, 3VA12/20/21/22, 3VA52/61/62) Terasaki (H125, L125, H160, L160, S160, E250, H250, L250)	
Width mm		90	90	105	105	105	
Height mm		215	215	240	240	240	
Approvals		–	–	UL	UL	UL	
For bar systems with centre-to-centre spacing mm		60	60	60	60	60	
For bar thickness mm		5/10	5/10	5/10	5/10	5/10	
Model No.	1 pc(s).	9342.500	9342.510	9342.610	9345.600	9345.610	
Product-specific scope of supply							
Terminal cover		■	■	■	–	–	
Sliding blocks		■	■	■	■	■	
Connection straps		–	–	–	■	■	
Accessories							
Support rail 35 x 15 mm		–	–	–	–	–	
Connection bracket	3 pc(s).	9342.570	9342.570	–	–	–	355
Insert strip		–	–	–	–	–	

Circuit-breaker component adaptors

Rated current max. 400 – 630 A, 3-pole

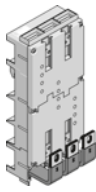
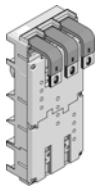
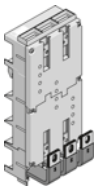
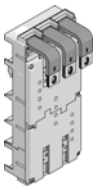
						
Rated current max. A	Packs of	400	400	630	630	Page
Rated operating voltage V, ~		690, 3~	690, 3~	690, 3~	690, 3~	
Number of poles		3-pole	3-pole	3-pole	3-pole	
Cable outlet		Top	Bottom	Top	Bottom	
Type of connection		–	–	–	–	
Connection of round conductors		–	–	–	–	
Clamping area for laminated copper bars (W x H)		–	–	–	–	
When using the Siemens VL630 switchgear, insert strip 9342.720 is additionally required		–	–	■	■	
For switchgear make (model)		Eaton (NZM3, NZM3 UL/400 A) GE (FG400) Mitsubishi (NF400-SEW/HEW/REW) Schneider Electric (NS(X)400, NSJ400) Schrack (MC3) Siemens (VL400, VL400X UL, VL400 UL, 3VA23, 3VA63) Terasaki (E400, S400, H400, L400)	Eaton (NZM3, NZM3 UL/400 A) GE (FG400) Mitsubishi (NF400-SEW/HEW/REW) Schneider Electric (NS(X)400, NSJ400) Schrack (MC3) Siemens (VL400, VL400X UL, VL400 UL, 3VA23, 3VA63) Terasaki (E400, S400, H400, L400)	ABB (S5, T5, T5 UL) Allen Bradley (140U-L) Eaton (NZM3, NZM3 UL/630 A) GE (FG630) Legrand (DPX 630) Mitsubishi (NF630-SEW/HEW/REW) OEZ (BH630N, BH630S) Schneider Electric (NS(X)630, NSJ600) Schrack (MC3) Siemens (VL630, 3VA24, 3VT3, 3V10 73, 3RV13 73, 3RV13 74, 3VA64) Terasaki (E630, S630)	ABB (S5, T5, T5 UL) Allen Bradley (140U-L) Eaton (NZM3, NZM3 UL/630 A) GE (FG630) Legrand (DPX 630) Mitsubishi (NF630-SEW/HEW/REW) OEZ (BH630N, BH630S) Schneider Electric (NS(X)630, NSJ600) Schrack (MC3) Siemens (VL630, 3VA24, 3VT3, 3V10 73, 3RV13 73, 3RV13 74, 3VA64) Terasaki (E630, S630)	
Width mm		140	140	140	140	
Height mm		345	345	345	345	
Approvals		UL	UL	UL	UL	
For bar systems with centre-to-centre spacing mm		60	60	60	60	
For bar thickness mm		5/10	5/10	5/10	5/10	
Model No.	1 pc(s).	9345.720	9345.730	9345.700	9345.710	
Product-specific scope of supply						
Connection straps		■	■	■	■	
Sliding blocks		■	■	■	■	
Accessories						
Support rail 35 x 15 mm		–	–	–	–	
Connection bracket		–	–	–	–	
Insert strip	4 pc(s).	9342.720	9342.720	9342.720	9342.720	353

Circuit-breaker component adaptors



Busbar system Page 300 Connection adaptors Page 304

Material:

- Polyamide
- Fire protection corresponding to UL 94-V0

Colour:

- RAL 7035

Note:

- Cable outlet: Switch outlet or as outgoing cable from the switchgear
- The technical data may vary for UL applications

Rated current max. 160 – 250 A, 4-pole

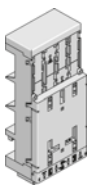
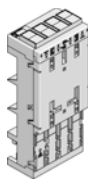
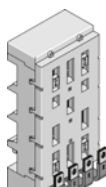
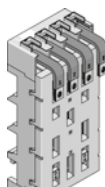
						
Rated current max. A	Packs of	160	160	250	250	Page
Rated operating voltage V, ~		690, 4~	690, 4~	690, 4~	690, 4~	
Number of poles		4-pole	4-pole	4-pole	4-pole	
Cable outlet		Top	Bottom	Top	Bottom	
Type of connection		Box terminal	Box terminal	-	-	
Connection of round conductors mm ²		35 - 120	35 - 120	-	-	
Clamping area for laminated copper bars (W x H) mm		18.5 x 15.5	18.5 x 15.5	-	-	
For switchgear make (model)		ABB (T1, T2, XT1, XT2) Eaton (NZM1-4/125 A, BZM E1-4/100 A) Schneider Electric (NSC100) Schrack (MC1) Siemens (3VA10, 3VA11)	ABB (T1, T2, XT1, XT2) Eaton (NZM1-4/125 A, BZM E1-4/100 A) Schneider Electric (NSC100) Schrack (MC1) Siemens (3VA10, 3VA11)	ABB (T3S, XT3) Eaton (NZM2-4/250 A) Schneider Electric (NS(X)100, NS(X)160, NS(X)250) Schrack (MC2) Siemens (VL160X, VL160, VL250, 3RV10 63, 3VA12/20/21/22, 3VA61/62)	ABB (T3S, XT3) Eaton (NZM2-4/250 A) Schneider Electric (NS(X)100, NS(X)160, NS(X)250) Schrack (MC2) Siemens (VL160X, VL160, VL250, 3RV10 63, 3VA12/20/21/22, 3VA61/62)	
Width mm		120	120	140	140	
Height mm		277	277	310	310	
Approvals		UL	UL	-	-	
For bar systems with centre-to-centre spacing mm		60	60	60	60	
For bar thickness mm		5/10	5/10	5/10	5/10	
Model No.	1 pc(s).	9342.504	9342.514	9345.604	9345.614	
Product-specific scope of supply						
Terminal cover		■	■	-	-	
Sliding blocks		■	■	■	■	
Connection straps		-	-	■	■	

Circuit-breaker component adaptors

Rated current max. 500 A, 4-pole

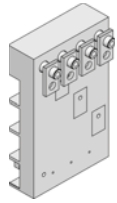
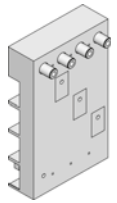
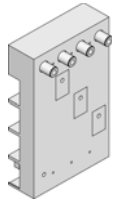
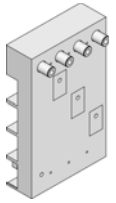
						
Rated current max. A	Packs of	500	500	500	500	Page
Rated operating voltage V, ~		690, 4~	690, 4~	690, 4~	690, 4~	
Number of poles		4-pole	4-pole	4-pole	4-pole	
Cable outlet		Bottom	Bottom	Bottom	Bottom	
Type of connection		-	-	-	-	
Connection of round conductors		-	-	-	-	
Clamping area for laminated copper bars (W x H)		-	-	-	-	
For switchgear make (model)		ABB (Tmax T5)	Schneider Electric (NS(X)400, NS(X)630)	Eaton (NZM3-4-XKR130)	Siemens (VL400)	
Width mm		185	185	185	185	
Height mm		300	300	300	300	
Approvals		-	-	-	-	
For bar systems with centre-to-centre spacing mm		60	60	60	60	
For bar thickness mm		5/10	5/10	5/10	5/10	
Model No.	1 pc(s).	9345.704	9345.714	9345.724	9345.734	
Product-specific scope of supply						
Copper spacer roll		■	■	■	■	
Connection screws		■	■	■	■	
Contact plates		■	-	-	-	

Rittal – The System.



VX25 Power Engineering

see page 446

OM adaptors with connection cables

Switchgear assignment

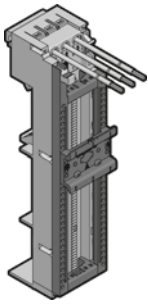

For make/model		Siemens												Schneider Electric																									
		Circuit-breaker			Starter						Reversing starter			Circuit-breaker	Starter					Reversing starter		Soft starter																	
		3RV10 11... (S00)	3RV10 21... (S0)	3RV10 31... (S2)	3RV20 11... (S00) screw terminal	3RV20 21... (S0) screw terminal up to 40 A	3RA11 10... (S00)	3RA11 20... (S0)	3RA11 30... (S2)	3RA21 10... (S00) screw terminal	3RV20 11... (S00 + S0) spring terminal block	3RA21 20... (S00/S0) screw terminal	3RA21 20... (S0) screw terminal	3RA61 20...	3RA12 10... (S00 + S00)	3RA11 20... (S0 + S0)	3RV10 31... + 3RT103... (S2 + S2)	3RA22 10... (S00) screw terminal	3RA22 20... (S0) screw terminal	GV2 - ME (screw terminal and spring terminal block)	GV2 - P	GV2 - RT, LE10, L10	GV3 BIS 65A	GV2 P + LC1D	GV2 ME + LC1D	GV2 - DM102 + LC1D/LC1K	GV2 - DP + LC1D/LC1K	GV3 + LC1D65	LUB 12	LUB 32	GV2 P + LC2D (AC)	GV2 ME + LC2D/LC2K (AC)	GV2 DM + LC2D/LC2K	GV2 DP + LC2D/LC2K	GV2 DP + LC2D/LC2K	GV2 ME + ATS			
		Construction width												Construction width																									
		45	45	55	45	45	45	55	45	45	45	45	45	45	90	100	120	90	90	45	55	45	55	45	45	45	45	45	55	45	45	90	90	90	90	90	45		
ModeNo.	Version	Required quantity (pieces)												Required quantity (pieces)																									
9340.760	OM adaptor 16 A, AWG 12, W = 45 mm										1																												
9340.340	OM adaptor 25 A, AWG 12, W = 45 mm	1	1	1																1		1							1										
9340.350	OM adaptor 32 A, AWG 10, W = 45 mm										1	1						1						1	1	1	1		1	1	1	1	1	1	1	1	1		
9340.770	OM adaptor 32 A, AWG 10, W = 45 mm												1																										
9340.370	OM adaptor 25 A, AWG 12, W = 45 mm					1	1		1						1	1	1																						
9340.390	OM adaptor 25 A, AWG 12, W = 45 mm																																					1	
9340.430	OM adaptor 65 A, AWG 6, W = 55 mm			1																1		1																	
9340.450	OM adaptor 65 A, AWG 6, W = 55 mm						1										1											1											
9340.720	OM adaptor 40 A, AWG 8, W = 55 mm				1																																		
9340.260	OM support, 45 x 208 mm														1	1		1												1	1	1	1	1	1	1	1		
9340.270	OM support, 55 x 272 mm																1		1																				
9340.290	Insert strip, 10 x 208 mm																1	1																					
9340.280	Connection pin														3	3	3	3	3															3	3	3	3	3	
9342.800	PinBlock, W = 45 mm										1	1												1	1	1	1						2	2	2	2	2		
9342.820	PinBlock PLUS												1											1	1	1	1												

OM adaptors with spring terminal blocks

Switchgear assignment

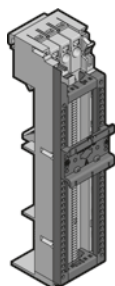

For make/model

ABB													Eaton																				
Circuit-breaker				Starter			Reversing starter			Soft starter			Circuit-breaker				Starter				Reversing starter		Soft starter										
MS 116/132													MS 116 + PSR3, PSR6, PSR9, PSR12, PSR16, PSR25																				
MS 325													MS 325 + PSR25				PKZM0																
MS 450/451													MS 450 + PSR30				PKZM01																
MS 495/496/497																	PKZM4																
																	PKE12																
																	PKE32																
																	PKE65																
																	MSC-D + M7 - M15																
																	MSC-D + M17 - M32																
																	PKZM4 + DILM 17-65																
																	MSC - DE ... M7 - M12																
																	MSC - DE ... M17 - M32																
																	PKE 65 + DILM 65																
																	MSC - R ... M7 - M12																
																	MSC - R ... M17 - M32																
																	PKE 65 + DILM 65																
																	PKE 12 + DS7-340																
																	PKE 32 + DS7-340																
																	PKZ0 + DS7-340																
Construction width													Construction width																				
45	54	55	70	45	45	70	90	90	140	45	45	55	45	45	55	45	45	55	45	45	55	45	45	55	45	45	55	90	90	110	45	45	45

Model No.	Version	Required quantity (pieces)											Required quantity (pieces)																					
		45	54	55	70	45	45	70	90	90	140	45	45	55	45	45	55	45	45	55	45	45	55	45	45	55	90	90	110	45	45	45		
9340.530	OM adaptor 32 A, 1.5 - 6 mm ² , W = 45 mm	1				1												1	1															
9340.550	OM adaptor 32 A, 1.5 - 6 mm ² , W = 45 mm								1															1	1									
9340.560	OM adaptor 32 A, 1.5 - 6 mm ² , W = 45 mm					1			1			1	1									1	1									1	1	1
9340.660	OM adaptor 32 A, 1.5 - 6 mm ² , W = 55 mm	1																																
9340.630	OM adaptor 65 A, 2.5 - 16 mm ² , W = 55 mm		1	1														1																
9340.650	OM adaptor 65 A, 2.5 - 16 mm ² , W = 55 mm								1		1						1											1			1			
9340.260	OM support, 45 x 208 mm								1	1																		1	1					
9340.270	OM support, 55 x 272 mm										1																			1				
9340.290	Insert strip, 10 x 208 mm				2				2		3																							
9340.280	Connection pin								3	3	3																	3	3	3				
9340.860	Cable set AWG 12	3				3			3		3	3	3								3			3				3			3			
9340.870	Cable set AWG 10		3						3		3							3	3									3			3		3	3
9340.890	Cable set AWG 6			3	3				3		3						3											3			3			
9342.860	Support rail TS45D, 35 x 10 mm	1																																
9342.930	Support rail TS55D, 35 x 10 mm								1																									

Bus-mounting fuse base



Busbar system Page 300 Connection adaptors Page 304 OM adaptors Page 307 Circuit-breaker component adaptors Page 314

Material:

- Bus-mounting fuse base: Fibreglass-reinforced, thermoplastic polyester (PBT)
- Contact hazard protection: Polyamide
- Fire protection corresponding to UL 94-V0

Colour:

- RAL 7035

Note:

- For the use of fuse inserts to EN 60 269-3 (DIN VDE 0636-3)

Design		-	Easy Connect	-	Easy Connect	-	Easy Connect	Page
Fuse inserts		D 02-E 18 (adaptor sleeve)	D 02-E 18 (adaptor sleeve)	D II-E 27 (adaptor sleeve)	D II-E 27 (adaptor sleeve)	D III-E 33 (adaptor sleeve)	D III-E 33 (adaptor sleeve)	
Rated current max. A		63	63	25	25	63	63	
Rated operating voltage V, ~		400, 3~ 400 (DC)	400, 3~ 400 (DC)	500, 3~ 500 (DC)	500, 3~ 500 (DC)	690, 3~ 690 (DC)	690, 3~ 690 (DC)	
Number of poles		3-pole	3-pole	3-pole	3-pole	3-pole	3-pole	
Type of connection		Box terminal	Box terminal	Box terminal	Box terminal	Box terminal	Box terminal	
Connection of round conductors mm ²		1.5 - 25	1.5 - 16	1.5 - 16	1.5 - 16	1.5 - 25	1.5 - 16	
Width mm		27	41	42	56	57	71	
Height mm		209	251	209	251	209	251	
For bar systems with centre-to-centre spacing mm		60	60	60	60	60	60	
For bar thickness mm		5/10	5/10	5/10	5/10	5/10	5/10	
Model No.		3418.010	3418.040	3427.010	3427.040	3433.010	3433.040	
	Packs of	10 pc(s).	5 pc(s).	10 pc(s).	5 pc(s).	10 pc(s).	5 pc(s).	
Product-specific scope of supply								
Pre-configured element ready for connection including cover plate, contact hazard protection and exterior connection clamps		-	■	-	■	-	■	
Also required								
Contact hazard protection cover plate	10 pc(s).	3418.020	-	3427.020	-	3433.020	-	356
Accessories								
Connection space extender	10 pc(s).	3418.030	-	3427.030	-	3433.030	-	356
Cover, side	10 pc(s).	3093.010	-	3093.020	-	3093.020	-	356

Bus-mounting fuse base D-Switch



Busbar system Page 300 **Connection adaptors** Page 304 **OM adaptors** Page 307 **Circuit-breaker component adaptors** Page 314

Material:

- Polyamide
- Fire protection corresponding to UL 94-V0

Colour:

- Chassis: RAL 7035
- Fuse holder: RAL 7001

Supply includes:

- Retaining springs for D 01 and 10 x 38 mm fuses

Basis of test:

- IEC/DIN EN 60 947-3

Note:

- For the use of fuse inserts to EN 60 269-3 (DIN VDE 0636-3)
- With integral visual fuse monitoring via flashing indicator and operating status display as well as cable routing for conductors up to 6 mm²

Fuse inserts	Packs of	D 01 (with retaining spring) D 02 (with Neozeed adaptor sleeve) 10 x 38 (with retaining spring)	Page
Rated operating current max. A		63	
Rated operating voltage V, ~		400, 3~	
Number of poles		3-pole	
Voltage, indicator light V		100 - 400	
Type of connection		Box terminal	
Connection of round conductors mm ²		1.5 - 25	
Width mm		27	
Height mm		226	
For bar systems with centre-to-centre spacing mm		60	
For bar thickness mm		5/10	
Model No.	3 pc(s).	9340.950	
Accessories			
Wiring duct	10 pc(s).	9340.905	356

NH fuse-switch-disconnectors, size 000



Busbar system Page 300 **Connection adaptors** Page 304 **OM adaptors** Page 307 **Circuit-breaker component adaptors** Page 314

Material:

- Fibreglass-reinforced polyamide
- Fire protection corresponding to UL 94-V0
- Contact tracks: Silver-plated hard copper

Colour:

- Chassis: RAL 9011
- Cover: RAL 7035

Basis of test:

- IEC/DIN EN 60 947-3
- DIN EN 60 269-2 (fuse inserts)

Size 000, for mounting plate assembly

Size	Packs of	000	Page
Rated operating current max. A		100	
Rated operating voltage V, ~		690, 3~	
Number of poles		3-pole	
Cable outlet		Top/bottom	
Type of connection		Box terminal	
Connection of round conductors mm ²		1.5 - 50	
Clamping area for laminated copper bars (W x H) mm		10 x 10	
Width mm		89	
Height mm		141.5	
For mounting plate assembly		■	
Model No.	1 pc(s).	3431.000	
Accessories			
Micro-switch	5 pc(s).	3071.000	358

NH fuse-switch-disconnectors, size 000



Busbar system Page 300 **Connection adaptors** Page 304 **OM adaptors** Page 307 **Circuit-breaker component adaptors** Page 314

Material:

- Fibreglass-reinforced polyamide
- Fire protection corresponding to UL 94-V0
- Contact tracks: Silver-plated hard copper

Colour:

- Chassis: RAL 7035
- Cover: RAL 7001

Basis of test:

- IEC/DIN EN 60 947-3
- DIN EN 60 269-2 (fuse inserts)

Size 000

Size	Packs of	000	000	000	Page
Rated operating current max. A		100	100	100	
Rated operating voltage V, ~		690, 3~	690, 3~	690, 3~	
Number of poles		3-pole	3-pole	3-pole	
Cable outlet		Top	Bottom	Bottom	
Type of connection		Box terminal	Box terminal	Box terminal	
Connection of round conductors mm ²		2.5 - 50	2.5 - 50	2.5 - 50	
Width mm		53	53	53	
Height mm		213	213	213	
With electronic fuse monitoring		-	-	■	
For bar systems with centre-to-centre spacing mm		60	60	60	
For bar thickness mm		5/10	5/10	5/10	
Model No.	1 pc(s).	3431.020	3431.030	3431.035	
Accessories					
Micro-switch	5 pc(s).	3071.000	3071.000	3071.000	358

NH fuse-switch-disconnectors, size 00 to 3



Busbar system Page 300 **Connection adaptors** Page 304 **OM adaptors** Page 307 **Circuit-breaker component adaptors** Page 314

Material:

- Polyamide
- Fire protection corresponding to UL 94-V0
- Contact tracks: Electrolytic copper, silver-plated

Colour:

- Chassis: RAL 7035
- Cover: RAL 7035/7001

Basis of test:

- IEC/DIN EN 60 947-3
- DIN EN 60 269-2 (fuse inserts)

Note:

- The technical data may vary for UR applications. Applications to UR only in conjunction with "Special Purpose Fuses".

Size 00

Size	Packs of	00	00	00	00	Page
Rated operating current max. A		160	160	160	160	
Rated operating voltage V, ~		690, 3~	690, 3~	690, 3~	690, 3~	
Number of poles		3-pole	3-pole	3-pole	3-pole	
Cable outlet		Top/bottom	Top/bottom	Top/bottom	Top/bottom	
Type of connection		Box terminal	Screw M8	Box terminal	Screw M8	
Connection of round conductors mm ²		4 - 95	10 - 95	4 - 95	10 - 95	
Connection of sector-shaped conductors		-	-	-	-	
Clamping area for laminated copper bars (W x H) mm		13 x 13	20 x 5	13 x 13	20 x 5	
Width mm		106	106	106	106	
Height mm		194	194	194	194	
Approvals		UR	UR	UR	UR	
For mounting plate assembly		-	-	■	■	
For bar systems with centre-to-centre spacing mm		60	60	-	-	
For bar thickness mm		5/10	5/10	-	-	
Model No.	1 pc(s).	9343.000	9343.010	9344.000	9344.010	
Accessories						
Box terminal		-	-	-	-	
Connection space cover	2 pc(s).	9344.520	9344.520	9344.520	9344.520	357
Arcing chamber		-	-	-	-	
Micro-switch	5 pc(s).	3071.000	3071.000	3071.000	3071.000	358
Laminated copper bar		see page	see page	see page	see page	346
Smart monitoring system	1 pc(s).	9343.070	-	-	-	333

NH fuse-switch-disconnectors, size 00 to 3

Size 1

Size	Packs of	1	1	1	1	Page
Rated operating current max. A		250	250	250	250	
Rated operating voltage V, ~		690, 3~	690, 3~	690, 3~	690, 3~	
Number of poles		3-pole	3-pole	3-pole	3-pole	
Cable outlet		Top/bottom	Top/bottom	Top/bottom	Top/bottom	
Type of connection		Box terminal	Screw M10	Box terminal	Screw M10	
Connection of round conductors mm ²		35 - 150	10 - 150	35 - 150	10 - 150	
Connection of sector-shaped conductors mm ²		50 - 150	–	50 - 150	–	
Clamping area for laminated copper bars (W x H) mm		20 x 3 - 14	32 x 10	20 x 3 - 14	32 x 10	
Width mm		184	184	184	184	
Height mm		298	298	298	298	
Approvals		UR	UR	UR	UR	
For mounting plate assembly		–	–	■	■	
For bar systems with centre-to-centre spacing mm		60	60	–	–	
For bar thickness mm		5/10	5/10	–	–	
Model No.	1 pc(s).	9343.100	9343.110	9344.100	9344.110	
Accessories						
Box terminal	3 pc(s).	–	9344.610	–	9344.610	357
Connection space cover	2 pc(s).	9344.530	9344.530	9344.530	9344.530	357
Arcing chamber	3 pc(s).	9344.680	9344.680	9344.680	9344.680	357
Micro-switch	2 pc(s).	9344.510	9344.510	9344.510	9344.510	358
Laminated copper bar		see page	see page	see page	see page	346
Smart monitoring system	1 pc(s).	9343.170	–	–	–	333

Size 2 – 3

Size	Packs of	2	2	2	3	3	3	Page
Rated operating current max. A		400	400	400	630	630	630	
Rated operating voltage V, ~		690, 3~	690, 3~	690, 3~	690, 3~	690, 3~	690, 3~	
Number of poles		3-pole	3-pole	3-pole	3-pole	3-pole	3-pole	
Cable outlet		Top/bottom	Top/bottom	Top/bottom	Top/bottom	Top/bottom	Top/bottom	
Type of connection		Box terminal	Screw M10	Screw M10	Box terminal	Screw M10	Screw M10	
Connection of round conductors mm ²		95 - 300	10 - 240	10 - 240	95 - 300	10 - 300	10 - 300	
Connection of sector-shaped conductors mm ²		120 - 300	–	–	120 - 300	–	–	
Clamping area for laminated copper bars (W x H) mm		32 x 10 - 20	50 x 10	50 x 10	32 x 10 - 20	50 x 10	50 x 10	
Width mm		210	210	210	250	250	250	
Height mm		298	298	298	298	298	298	
Approvals		UR	UR	UR	UR	UR	UR	
For mounting plate assembly		–	–	■	–	–	■	
For bar systems with centre-to-centre spacing mm		60	60	–	60	60	–	
For bar thickness mm		5/10	5/10	–	5/10	5/10	–	
Model No.	1 pc(s).	9343.200	9343.210	9344.210	9343.300	9343.310	9344.310	
Accessories								
Box terminal	3 pc(s).	–	9344.620	9344.620	–	9344.620	9344.620	357
Connection space cover	2 pc(s).	9344.540	9344.540	9344.540	9344.550	9344.550	9344.550	357
Arcing chamber	3 pc(s).	9344.680	9344.680	9344.680	9344.680	9344.680	9344.680	357
Micro-switch	2 pc(s).	9344.510	9344.510	9344.510	9344.510	9344.510	9344.510	358
Laminated copper bar		see page	see page	see page	see page	see page	see page	346
Smart monitoring system	1 pc(s).	9343.270	–	–	9343.370	–	–	333

NH fuse-switch-disconnectors, size 00 to 3



Busbar system Page 300 **Connection adaptors** Page 304 **OM adaptors** Page 307 **Circuit-breaker component adaptors** Page 314

Material:

- Polyamide
- Fire protection corresponding to UL 94-V0
- Contact tracks: Electrolytic copper, silver-plated

Colour:

- Chassis: RAL 7035
- Cover: RAL 7035/7001

Basis of test:

- IEC/DIN EN 60 947-3
- DIN EN 60 269-2 (fuse inserts)

Size 00, with electronic fuse monitoring

Size	Packs of	00	00	00	00	Page
Rated operating current max. A		160	160	160	160	
Rated operating voltage V, ~		400 - 690, 3~	400 - 690, 3~	400 - 690, 3~	400 - 690, 3~	
Number of poles		3-pole	3-pole	3-pole	3-pole	
Cable outlet		Top/bottom	Top/bottom	Top/bottom	Top/bottom	
Type of connection		Box terminal	Screw M8	Box terminal	Screw M8	
Connection of round conductors mm ²		4 - 95	10 - 95	4 - 95	10 - 95	
Connection of sector-shaped conductors		-	-	-	-	
Clamping area for laminated copper bars (W x H) mm		13 x 13	20 x 5	13 x 13	20 x 5	
Width mm		106	106	106	106	
Height mm		194	194	194	194	
For mounting plate assembly		-	-	■	■	
For bar systems with centre-to-centre spacing mm		60	60	-	-	
For bar thickness mm		5/10	5/10	-	-	
Model No.	1 pc(s).	9343.020	9343.030	9344.020	9344.030	
Accessories						
Box terminal		-	-	-	-	
Connection space cover	2 pc(s).	9344.520	9344.520	9344.520	9344.520	357
Arcing chamber		-	-	-	-	
Micro-switch	5 pc(s).	3071.000	3071.000	3071.000	3071.000	358
Laminated copper bar		see page	see page	see page	see page	346
Smart monitoring system	1 pc(s).	9343.070	-	-	-	333

NH fuse-switch-disconnectors, size 00 to 3

Size 1, with electronic fuse monitoring

Size	Packs of	1	1	1	Page
Rated operating current max. A		250	250	250	
Rated operating voltage V, ~		400 - 690, 3~	400 - 690, 3~	400 - 690, 3~	
Number of poles		3-pole	3-pole	3-pole	
Cable outlet		Top/bottom	Top/bottom	Top/bottom	
Type of connection		Box terminal	Screw M10	Screw M10	
Connection of round conductors mm ²		35 - 150	10 - 150	10 - 150	
Connection of sector-shaped conductors mm ²		50 - 150	–	–	
Clamping area for laminated copper bars (W x H) mm		20 x 3 - 14	32 x 10	32 x 10	
Width mm		184	184	184	
Height mm		298	298	298	
For mounting plate assembly		–	–	■	
For bar systems with centre-to-centre spacing mm		60	60	–	
For bar thickness mm		5/10	5/10	–	
Model No.	1 pc(s).	9343.120	9343.130	9344.130	

Accessories

Box terminal	3 pc(s).	–	9344.610	9344.610	357
Connection space cover	2 pc(s).	9344.530	9344.530	9344.530	357
Arcing chamber	3 pc(s).	9344.680	9344.680	9344.680	357
Micro-switch	2 pc(s).	9344.510	9344.510	9344.510	358
Laminated copper bar		see page	see page	see page	346
Smart monitoring system	1 pc(s).	9343.170	–	–	333

Size 2 – 3, with electronic fuse monitoring

Size	Packs of	2	2	3	3	Page
Rated operating current max. A		400	400	630	630	
Rated operating voltage V, ~		400 - 690, 3~	400 - 690, 3~	400 - 690, 3~	400 - 690, 3~	
Number of poles		3-pole	3-pole	3-pole	3-pole	
Cable outlet		Top/bottom	Top/bottom	Top/bottom	Top/bottom	
Type of connection		Screw M10	Screw M10	Screw M10	Screw M10	
Connection of round conductors mm ²		10 - 240	10 - 240	10 - 300	10 - 300	
Connection of sector-shaped conductors		–	–	–	–	
Clamping area for laminated copper bars (W x H) mm		50 x 10	50 x 10	50 x 10	50 x 10	
Width mm		210	210	250	250	
Height mm		298	298	298	298	
For mounting plate assembly		–	■	–	■	
For bar systems with centre-to-centre spacing mm		60	–	60	–	
For bar thickness mm		5/10	–	5/10	–	
Model No.	1 pc(s).	9343.230	9344.230	9343.330	9344.330	

Accessories

Box terminal	3 pc(s).	9344.620	9344.620	9344.620	9344.620	357
Connection space cover	2 pc(s).	9344.540	9344.540	9344.550	9344.550	357
Arcing chamber	3 pc(s).	9344.680	9344.680	9344.680	9344.680	357
Micro-switch	2 pc(s).	9344.510	9344.510	9344.510	9344.510	358
Laminated copper bar		see page	see page	see page	see page	346
Smart monitoring system		–	–	–	–	

NH fuse-switch-disconnectors, size 00 to 3



Busbar system Page 300 **Connection adaptors** Page 304 **OM adaptors** Page 307 **Circuit-breaker component adaptors** Page 314

Material:

- Polyamide
- Fire protection corresponding to UL 94-V0
- Contact tracks: Electrolytic copper, silver-plated

Colour:

- Chassis: RAL 7035
- Cover: RAL 7035/7001

Basis of test:

- IEC/DIN EN 60 947-3
- DIN EN 60 269-2 (fuse inserts)

Size 00, with electromechanical fuse monitoring

Size	Packs of	00	00	00	00	Page
Rated operating current max. A		160	160	160	160	
Rated operating voltage V, ~		690, 3~	690, 3~	690, 3~	690, 3~	
Number of poles		3-pole	3-pole	3-pole	3-pole	
Cable outlet		Top/bottom	Top/bottom	Top/bottom	Top/bottom	
Type of connection		Box terminal	Screw M8	Box terminal	Screw M8	
Connection of round conductors mm ²		4 - 95	10 - 95	4 - 95	10 - 95	
Connection of sector-shaped conductors		-	-	-	-	
Clamping area for laminated copper bars (W x H) mm		13 x 13	20 x 5	13 x 13	20 x 5	
Width mm		106	106	106	106	
Height mm		194	194	194	194	
For mounting plate assembly		-	-	■	■	
For bar systems with centre-to-centre spacing mm		60	60	-	-	
For bar thickness mm		5/10	5/10	-	-	
Model No.	1 pc(s).	9343.040	9343.050	9344.040	9344.050	
Accessories						
Box terminal		-	-	-	-	
Connection space cover	2 pc(s).	9344.520	9344.520	9344.520	9344.520	357
Arcing chamber		-	-	-	-	
Micro-switch	5 pc(s).	3071.000	3071.000	3071.000	3071.000	358
Laminated copper bar		see page	see page	see page	see page	346
Smart monitoring system	1 pc(s).	9343.070	-	-	-	333

NH fuse-switch-disconnectors, size 00 to 3

Size 1, with electromechanical fuse monitoring

Size	Packs of	1	1	1	Page
Rated operating current max. A		250	250	250	
Rated operating voltage V, ~		690, 3~	690, 3~	690, 3~	
Number of poles		3-pole	3-pole	3-pole	
Cable outlet		Top/bottom	Top/bottom	Top/bottom	
Type of connection		Box terminal	Screw M10	Screw M10	
Connection of round conductors mm ²		35 - 150	10 - 150	10 - 150	
Connection of sector-shaped conductors mm ²		50 - 150	–	–	
Clamping area for laminated copper bars (W x H) mm		20 x 3 - 14	32 x 10	32 x 10	
Width mm		184	184	184	
Height mm		298	298	298	
For mounting plate assembly		–	–	■	
For bar systems with centre-to-centre spacing mm		60	60	–	
For bar thickness mm		5/10	5/10	–	
Model No.	1 pc(s).	9343.140	9343.150	9344.150	

Accessories

Box terminal	3 pc(s).	–	9344.610	9344.610	357
Connection space cover	2 pc(s).	9344.530	9344.530	9344.530	357
Arcing chamber	3 pc(s).	9344.680	9344.680	9344.680	357
Micro-switch	2 pc(s).	9344.510	9344.510	9344.510	358
Laminated copper bar		see page	see page	see page	346
Smart monitoring system	1 pc(s).	9343.170	–	–	333

Size 2 – 3, with electromechanical fuse monitoring

Size	Packs of	2	2	3	3	Page
Rated operating current max. A		400	400	630	630	
Rated operating voltage V, ~		690, 3~	690, 3~	690, 3~	690, 3~	
Number of poles		3-pole	3-pole	3-pole	3-pole	
Cable outlet		Top/bottom	Top/bottom	Top/bottom	Top/bottom	
Type of connection		Screw M10	Screw M10	Screw M10	Screw M10	
Connection of round conductors mm ²		10 - 240	10 - 240	10 - 300	10 - 300	
Connection of sector-shaped conductors		–	–	–	–	
Clamping area for laminated copper bars (W x H) mm		50 x 10	50 x 10	50 x 10	50 x 10	
Width mm		210	210	250	250	
Height mm		298	298	298	298	
For mounting plate assembly		–	■	–	■	
For bar systems with centre-to-centre spacing mm		60	–	60	–	
For bar thickness mm		5/10	–	5/10	–	
Model No.	1 pc(s).	9343.250	9344.250	9343.350	9344.350	

Accessories

Box terminal	3 pc(s).	9344.620	9344.620	9344.620	9344.620	357
Connection space cover	2 pc(s).	9344.540	9344.540	9344.550	9344.550	357
Arcing chamber	3 pc(s).	9344.680	9344.680	9344.680	9344.680	357
Micro-switch	2 pc(s).	9344.510	9344.510	9344.510	9344.510	358
Laminated copper bar		see page	see page	see page	see page	346
Smart monitoring system		–	–	–	–	



NH fuse-switch disconnectors Page 325

Compact measurement unit consisting of measurement data acquisition unit, evaluation electronics, communication module, measurement power supply and flash data memory.

Functions:

- Continuous measurement of energy-related data
- Data logging in CSV format (Excel)
- Individual limit monitoring and alarm function
- May be integrated into the CMC III monitoring system
- Automatic address allocation via CAN bus

Material:

- Polyamide
- Fire protection corresponding to UL 94-V0

Colour:

- RAL 7035

Supply includes:

- NH measurement module
- Connector 2 x 2.5 mm² with preassembled bridge
- USB cable (mini-B connector on micro-B jack)

NH measurement module for NH fuse-switch disconnectors

For size	Packs of	00	1	2	3	Page
To fit Model No.		9343.000/ 9343.020/ 9343.040	9343.100/ 9343.120/ 9343.140	9343.200	9343.300	
Rated operating current max. A		150	250	400	600	
Rated operating voltage V, ~		400, 3~	400, 3~	400, 3~	400, 3~	
Number of poles		3-pole	3-pole	3-pole	3-pole	
Cable outlet		Bottom	Bottom	Bottom	Bottom	
Type of connection		Box terminal	Box terminal	Box terminal	Box terminal	
Connection of round conductors mm ²		4 - 95	35 - 150	95 - 300	95 - 300	
Connection of sector-shaped conductors mm ²		-	50 - 150	120 - 300	120 - 300	
Clamping area for laminated copper bars (W x H) mm		13 x 13	20 x 3 - 14	32 x 10 - 20	32 x 10 - 20	
Width mm		102	170	185	214	
Height mm		108	123	123	123	
Depth mm		68	92	107	107	
Precision class measurement output (voltage/current/power)		0.2 / 1.5 / 2	0.2 / 1.5 / 2	0.2 / 1.5 / 2	0.2 / 1.5 / 2	
Interfaces		2 x CAN bus (RJ45) 2 x Modbus RTU (RJ45) 1 x USB	2 x CAN bus (RJ45) 2 x Modbus RTU (RJ45) 1 x USB	2 x CAN bus (RJ45) 2 x Modbus RTU (RJ45) 1 x USB	2 x CAN bus (RJ45) 2 x Modbus RTU (RJ45) 1 x USB	
Model No.	1 pc(s).	9343.070	9343.170	9343.270	9343.370	

Smart monitoring system

Accessories



LCD display

for monitoring

Functions:

- Illuminated display with more than 50 measurement parameters
- Intuitive configuration of alarm and limit values
- Voltage supply for display via pluggable RJ12 patch cable

Material:

- Polyphenylene ether (PPE)

Colour:

- RAL 9005

Protection category IP to IEC 60 529:

- IP 51 (front)
- IP 41 (enclosure)

Supply includes:

- LCD display
- Modbus RTU cable (RJ12), length: 2 m

Interfaces	1 x Modbus RTU (RJ12)
Operating temperature range	-5 °C...+55 °C
Storage temperature range	-25 °C...+70 °C
Operating humidity range %	5 - 95
Width mm	96
Height mm	96
Depth mm	46
Packs of	1 pc(s).
Model No.	9343.410



Also required:

- Power pack, see page 334



Power pack

for LCD display

For mounting on support rails to EN 60 715, 7.5 mm high.

Material:

- Polycarbonate
- Fire protection corresponding to UL 94-V0

Colour:

- RAL 9005

Protection category IP to IEC 60 529:

- IP 20

Supply includes:

- Power pack
- Connector 2 x 2.5 mm²

Interfaces	1 x Modbus RTU (RJ12) 2 x Modbus RTU (RJ45)
Operating temperature range	-5 °C...+55 °C
Storage temperature range	-25 °C...+70 °C
Operating humidity range %	5 - 95
Width mm	71
Height mm	91
Depth mm	61
Rated operating voltage V, Hz	85 - 265 (AC/DC), 50/60
Output current (max.) A	0.42
Output voltage V (DC)	24
Packs of	1 pc(s).
Model No.	9343.400

NH slimline fuse-switch disconnectors



Busbar system Page 300 Connection adaptors Page 304 NH slimline fuse-switch disconnectors 185 mm Page 374

Material:

- Fibreglass-reinforced polyamide
- Fire protection corresponding to UL 94-V0
- Contact tracks: Silver-plated hard copper

Colour:

- Chassis: RAL 7035
- Cover: RAL 7001
- Handle: RAL 7016

Basis of test:

- IEC/DIN EN 60 947-3
- DIN EN 60 269-2 (fuse inserts)

Size 00

Size	Packs of	00	00	00	00	00	Page
Rated operating current max. A		160	160	160	160	160	
Rated operating voltage V, ~		690, 3~	690, 3~	690, 3~	690, 3~	690, 3~	
Number of poles		3-pole	3-pole	3-pole	3-pole	3-pole	
Cable outlet		Top/bottom	Top/bottom	Top/bottom	Top/bottom	Top/bottom	
Type of connection		Box terminal	Screw M8	Box terminal	Screw M8	Screw M8	
Connection of round conductors mm ²		2.5 - 95	2.5 - 95	2.5 - 95	2.5 - 95	2.5 - 95	
Width mm		50	50	50	50	50	
Height mm		400	400	400	400	400	
For converter installation		-	-	-	-	■	
For bar systems with centre-to-centre spacing mm		60	60	100	100	100	
For bar thickness mm		5/10	5/10	5/10	5/10	5/10	
Model No.	1 pc(s).	9346.000	9346.010	9346.020	9346.030	9346.060	
Product-specific scope of supply							
3 mounting hooks		■	■	■	■	-	
Accessories							
Connection space cover	1 pc(s).	9346.460	9346.460	9346.460	9346.460	9346.460	357
Clamp-type terminal connection	3 pc(s).	-	3592.010	-	3592.010	3592.010	358
Micro-switch	5 pc(s).	9346.400	9346.400	9346.400	9346.400	9346.400	358

NH slimline fuse-switch disconnectors



Busbar system Page 300 Connection adaptors Page 304 NH slimline fuse-switch disconnectors 185 mm Page 374

Material:

- Fibreglass-reinforced polyamide
- Fire protection corresponding to UL 94-V0
- Contact tracks: Silver-plated hard copper

Colour:

- Chassis: RAL 7035
- Cover: RAL 7001
- Handle: RAL 7016

Basis of test:

- IEC/DIN EN 60 947-3
- DIN EN 60 269-2 (fuse inserts)

Size 00, with electronic fuse monitoring

Size	Packs of	00	Page
Rated operating current max. A		160	
Rated operating voltage V, ~		690, 3~	
Number of poles		3-pole	
Cable outlet		Top/bottom	
Type of connection		Screw M8	
Connection of round conductors mm ²		2.5 - 95	
Width mm		50	
Height mm		400	
For bar systems with centre-to-centre spacing mm		60	
For bar thickness mm		5/10	
Model No.	1 pc(s).	9346.015	
Product-specific scope of supply			
3 mounting hooks		■	
Accessories			
Connection space cover	1 pc(s).	9346.460	357
Clamp-type terminal connection	3 pc(s).	3592.010	358
Micro-switch	5 pc(s).	9346.400	358



Busbar system Page 300 **Connection adaptors** Page 304 **OM adaptors** Page 307 **Circuit-breaker component adaptors** Page 314

Material:

- Polyamide
- Fire protection corresponding to UL 94-V0

Colour:

- RAL 7035

Basis of test:

- UL 4248-4

Note:

- Not suitable for accommodating fuses 10 x 38 mm to IEC 60 269-2/-4/-6

Rated operating current max. 30 A

Fuse type (class)	Packs of	CC	Page
Rated operating current max. A		30	
Rated operating voltage V, ~		600, 3~	
Number of poles		3-pole	
Fuse standard		UL 248-4	
Fuse size mm		10 x 38	
Voltage, indicator light V		110 - 600	
Connection of round conductors mm ²		1.5 - 6	
Connection of round conductors		AWG 10 - 16	
Width mm		27	
Height mm		200	
For bar systems with centre-to-centre spacing mm		60	
For bar thickness mm		5/10	
Model No.	4 pc(s).	9345.040	

Fuse holders



Busbar system Page 300 **Busbar connection adaptors** Page 304 **OM adaptors** Page 307 **Circuit-breaker component adaptors** Page 314

Material:

- Polyamide
- Fire protection corresponding to UL 94-V0

Colour:

- RAL 7035

Basis of test:

- UL 4248-1
- UL 4248-4
- UL 4248-8

Note:

- For snap-on mounting on 35 mm (7.5 mm/15 mm high) support rails to DIN EN 60 715 or RiLine component adaptor adaptor combinations (OM adaptors/supports)

Rated operating current max. 30 – 60 A

Fuse type (class)		CC	J	J	Page
Rated operating current max. A		30	30	60	
Rated operating voltage V, ~		600, 3~	600, 3~	600, 3~	
Number of poles		3-pole	3-pole	3-pole	
Fuse standard		UL 248-4	UL 248-8	UL 248-8	
Fuse size mm		10 x 38	21 x 57	27 x 60	
Voltage, indicator light V		110 - 600	110 - 600	110 - 600	
Connection of round conductors mm ²		0.75 - 25	1.5 - 50	2.5 - 50	
Connection of round conductors		AWG 8 - 18	AWG 1 - 18	AWG 1 - 14	
Not suitable for accommodating fuses 10 x 38 mm to IEC 60 269-2/-4/-6		■	-	-	
Width mm		54	108	120	
Height mm		81	115	118	
Model No.		9345.005	9345.015	9345.035	
	Packs of	4 pc(s).	2 pc(s).	2 pc(s).	

Mounting example on 60 mm bar systems

Required accessories		For fuse holder			Page
Designation	Model No.	9345.005	9345.015	9345.035	
OM support	9340.260	-	1 pc(s).	-	313
OM support	9340.270	-	-	1 pc(s).	313
Connection pin	9340.280	-	3 pc(s).	6 pc(s).	354
Insert strip	9340.290	-	1 pc(s).	1 pc(s).	353
OM adaptor	9340.410	-	1 pc(s).	1 pc(s).	309
OM adaptor	9340.460	1 pc(s).	-	-	308
Support rail	9342.880	-	1 pc(s).	-	352
Support rail	9342.950	1 pc(s).	1 pc(s).	2 pc(s).	352



Busbar system Page 300 **Connection adaptors** Page 304 **OM adaptors** Page 307 **Circuit-breaker component adaptors** Page 314

Material:

- Polyamide
- Fire protection corresponding to UL 94-V0
- Contact tracks: Electrolytic copper, silver-plated

Colour:

- Chassis: RAL 7035
- Cover: RAL 7035/7001

Note:

- UL (listed accessory) is met when using the fuse holder on RiLine busbar systems

Standards:

- UL 508

Rated operating current max. 100 – 400 A

Fuse type (class)	Packs of	J	J	J	Page
Rated operating current min. A		61	101	201	
Rated operating current max. A		100	200	400	
Rated operating voltage V, ~		600, 3~	600, 3~	600, 3~	
Number of poles		3-pole	3-pole	3-pole	
Fuse standard		UL 248-8	UL 248-8	UL 248-8	
Fuse size mm		29 x 118	41 x 146	54 x 181	
Cable outlet		Top/bottom	Top/bottom	Top/bottom	
Type of connection		Box terminal	Box terminal	Box terminal	
Connection of round conductors		AWG 2 – MCM 300	AWG 4/0 – MCM 600	AWG 4/0 – MCM 600	
Width mm		184	210	250	
Height mm		288	288	328	
Approvals		UL	UL	UL	
For bar systems with centre-to-centre spacing mm		60	60	60	
For bar thickness mm		5/10	5/10	5/10	
Model No.	1 pc(s).	9345.100	9345.200	9345.400	

RiLine accessories

Busbars/base isolators



Busbar supports

1-pole

Material:

- Polyamide
- Fire protection corresponding to UL 94-V0

Colour:

- RAL 7035

Note:

- Multi-pole systems with 60 mm bar centre distance may be configured by buying the busbar supports

Approvals:

- UL



Also required:

- Busbars E-Cu, see page 342
- PLS special busbars E-Cu, see page 344



Accessories:

- Spacer, see page 341

For busbar mm	12 x 5/10 15 x 5 - 30 x 10	PLS 1600
Note on Model No.	If 12 x 5/10 mm busbars are used, spacer 9340.090 is additionally required	-
PEN/N/PE support	■	■
Rated operating voltage V, ~	1000, 1~ 1500 (DC)	1000, 1~ 1500 (DC)
Number of poles	Single-pole	Single-pole
Product-specific scope of supply	-	Including raised section for stepped configuration of the PLS busbars
Packs of	4 pc(s).	4 pc(s).
Model No.	9340.030	9342.030



Busbar supports

2-pole

Material:

- Polyamide
- Fire protection corresponding to UL 94-V0

Colour:

- RAL 7035



Also required:

- Busbars E-Cu, see page 342

For busbar mm	12 x 5	12 x 5 - 30 x 10
Bar centre distance mm	70	60
PEN/N/PE support	■	■
N/PE support	■	■
Rated operating voltage V, ~	1000, 2~ 1500 (DC)	1000, 2~
Number of poles	2-pole	2-pole
Approvals	-	UL
Packs of	4 pc(s).	4 pc(s).
Model No.	9600.005	9340.040

RiLine accessories

Busbars/base isolators

Spacer

for RiLine busbar supports (flat busbar system)

For adapting 12 x 5 and 12 x 10 mm size busbars.

Material:

- Polyamide
- Fire protection corresponding to UL 94-V0

Colour:

- RAL 7035

To fit Model No.	Packs of	Model No.
9340.000/9340.004/ 9340.010/9340.030	12 pc(s).	9340.090

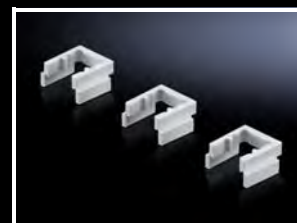

Base isolator

For configuring busbar systems with any given bar centre distances and for assembling insulated PE or PEN busbars.

Material:

- Duroplastic polyester (UP resin)

Height mm	40	50
Thread	M10	M10
Rated operating voltage kV	1	1
Tensile strength kN	12	13
Torsional strength Nm	75	90
Bending strength kN	6	6
Packs of	6 pc(s).	6 pc(s).
Model No.	3031.000	3032.000



RiLine accessories

Busbars



CUPONAL busbars

Copper-coated aluminium busbars, suitable for configuring busbar systems with busbar supports 9340.000/9340.050.

Material:

- Aluminium
- Copper

Note:

- The rated current is derived at 65 °C bar temperature and 35 °C ambient temperature
- Correction factor diagram to DIN EN 43 671
- May be cut individually to required length

Standards:

- DIN EN 13 601

**Short-circuit resistance diagram
9340.000/9340.050**

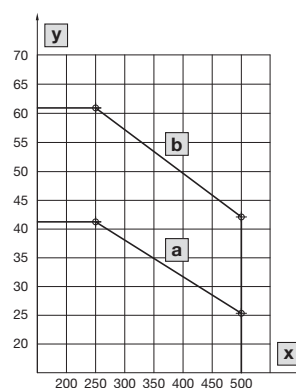

- x** Busbar support spacing (mm)
- y** Ip Surge-current resistance (kA)
- a** CUPONAL 20 x 5/10 mm
- b** CUPONAL 30 x 5/10 mm

Dimensions mm	Length mm	Rated current max. A	Packs of	Model No.
20 x 5	2400	235	6 pc(s).	3582.020
20 x 10	2400	363	3 pc(s).	3585.020
30 x 5	2400	328	6 pc(s).	3584.020
30 x 10	2400	493	3 pc(s).	3586.020

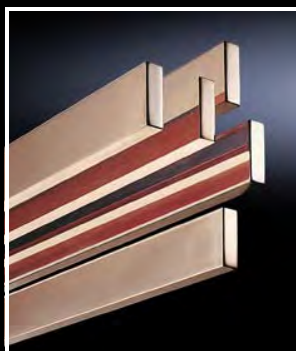

Busbars E-Cu

Material:

- E-Cu F30

Note:

- May be cut individually to required length

Standards:

- DIN EN 13 601



Accessories:

- Busbar connector, see page 343
- Busbar cover section, see page 343
- Inserted screw nuts M12, see page 1039

Dimensions mm	Length mm	Approvals	Packs of	Model No.
12 x 5	2400	UL	6 pc(s).	3580.000
15 x 5	2400	UL	6 pc(s).	3581.000
20 x 5	2400	UL	6 pc(s).	3582.000
25 x 5	2400	UL	6 pc(s).	3583.000
30 x 5	2400	UL	6 pc(s).	3584.000
12 x 10	2400	UL	6 pc(s).	3580.100
15 x 10	2400	UL	6 pc(s).	3581.100
20 x 10	2400	UL	3 pc(s).	3585.005
30 x 10	2400	UL	3 pc(s).	3586.005
40 x 10	2400	-	3 pc(s).	3587.000
50 x 10	2400	-	2 pc(s).	3588.005
60 x 10	2400	-	2 pc(s).	3589.005
80 x 10	2400	-	1 pc(s).	3590.005
100 x 10	2400	-	1 pc(s).	3590.015
120 x 10	2400	-	1 pc(s).	3590.020

Busbar cover section

Contact hazard protection by covering the busbars.

Material:

- Thermally modified hard PVC.
- Fire protection corresponding to UL 94-V0

Colour:

- RAL 7035

Note:

- May be cut individually to required length

For busbar mm	Length mm	Approvals	Packs of	Model No.
12/15 x 5	1000	-	4 pc(s).	9350.010
12/15 x 10	1000	-	4 pc(s).	9350.060
12 x 5 - 30 x 10	1000	UR	10 pc(s).	3092.000
40 - 60 x 10	1000	UR	10 pc(s).	3085.000



Busbar connector

For connecting rectangular busbars, no drilling required.

Approvals:

- UL

For busbar mm	Connection type	Material	Packs of	Model No.
12 x 5 - 15 x 10	Single connection	Console: St 37, nickel-plated Contact plate: E-Cu, nickel-plated	3 pc(s).	9350.075
20 x 5 - 30 x 10	Single connection	Top piece: Sheet steel, zinc-plated, passivated Contact plate: E-Cu, silver-plated	3 pc(s).	9320.020
20 x 5 - 30 x 10	Baying connection from enclosure to enclosure	Top piece: Sheet steel, zinc-plated, passivated Contact plate: E-Cu, silver-plated	3 pc(s).	9320.030



RiLine accessories

Busbars



PLS special busbars E-Cu

Material:

- E-Cu

Note:

- May be cut individually to required length

Approvals:

- UL



Accessories:

- PLS busbar connectors, see page 344
- PLS expansion connectors, see page 345

For system PLS 800

For enclosure width mm	Cross-section mm ²	Length mm	Bar thickness mm	Packs of	Model No.
600	300	495	5	3 pc(s).	3524.000
800	300	695	5	3 pc(s).	3525.000
1000	300	895	5	3 pc(s).	3525.010
1200	300	1095	5	3 pc(s).	3526.000
-	300	2400	5	1 pc(s).	3509.000

For system PLS 1600

For enclosure width mm	Cross-section mm ²	Length mm	Bar thickness mm	Packs of	Model No.
600	900	495	10	3 pc(s).	3527.000
800	900	695	10	3 pc(s).	3528.000
1000	900	895	10	3 pc(s).	3528.010
1200	900	1095	10	3 pc(s).	3529.000
-	900	2400	10	1 pc(s).	3516.000

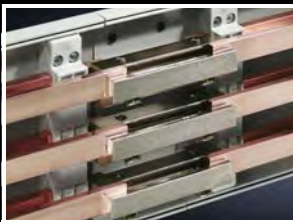

PLS busbar connectors

For connecting the PLS special busbars; no drilling required.

Material:

- E-Cu

Surface finish:

- Nickel-plated

Approvals:

- UL

For system PLS 800

Connection type	Packs of	Model No.
Single connection	3 pc(s).	3504.000
Baying connection from enclosure to enclosure	3 pc(s).	3505.000

For system PLS 1600

Connection type	Packs of	Model No.
Single connection	3 pc(s).	3514.000
Baying connection from enclosure to enclosure	3 pc(s).	3515.000

PLS expansion connectors

For thermal and mechanical compensation when connecting PLS special busbars from enclosure to enclosure.

Material:

- E-Cu

Note:

- At a temperature increase of 30 K, there is an expansion in the length of the busbars by approximately 0.5 mm/m. For this reason, it is advisable to use an expanding connection for thermal compensation in busbar systems with busbar sections > 3600 mm.

Approvals:

- UR

For system	Packs of	Model No.
PLS 800	3 pc(s).	9320.060
PLS 1600	3 pc(s).	9320.070



Also required:

- PLS busbar connectors, see page 344



Assembly instruction:

- Two busbar connectors are needed to fit one expansion connector.

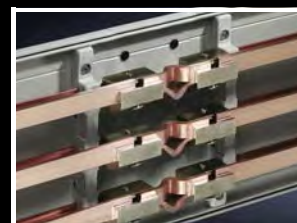

The Copper Workstation CW 120-M is ideal for bending, punching and cutting busbars, from page 639

RiLine accessories

Laminated copper bars



Laminated copper bars

Material:

- Cu lamina High-purity electrolyte copper F20
- Insulation: Highly resistant vinyl compound, elongation 370%, temperature: -30 °C...+105 °C, fire protection corresponding to UL-94 V0, dielectric strength: 20 kV/mm

Note:

- Construction = Number of lamina x lamina width x lamina thickness
- May be cut individually to required length
- The conductor temperature of the laminated copper bar is derived by adding the ambient temperature and the temperature increase together. Example: 3565.005 carrying 180 A, i.e. the temperature increases by 30 K. At an ambient temperature of 35 °C, this produces a resultant conductor temperature of 35 °C + 30 K = 65 °C.



Accessories:

- Universal support, see page 346

Construction mm	Length mm	Rated current (at 70 K) A	Rated current (at 50 K) A	Rated current (at 30 K) A	Packs of	Model No.
6 x 9 x 0.8	2000	285	240	180	1 pc(s).	3565.005
6 x 15.5 x 0.8	2000	415	350	265	1 pc(s).	3568.005
10 x 15.5 x 0.8	2000	575	480	365	1 pc(s).	3569.005
5 x 20 x 1	2000	525	435	330	1 pc(s).	3570.005
5 x 24 x 1	2000	605	510	385	1 pc(s).	3571.005
10 x 24 x 1	2000	920	770	585	1 pc(s).	3572.005
5 x 32 x 1	2000	770	645	485	1 pc(s).	3573.005
10 x 32 x 1	2000	1155	965	730	1 pc(s).	3574.005
5 x 40 x 1	2000	930	780	590	1 pc(s).	3575.005
10 x 40 x 1	2000	1370	1145	865	1 pc(s).	3576.005
5 x 50 x 1	2000	1125	940	710	1 pc(s).	3577.005
10 x 50 x 1	2000	1635	1365	1030	1 pc(s).	3578.005
10 x 63 x 1	2000	1950	1610	1230	1 pc(s).	3579.005



Universal support

for laminated copper bars

For the attachment of laminated copper bars from 5 x 20 x 1 to 10 x 63 x 1 mm.

Material:

- Fibreglass-reinforced, thermoplastic polyester (PBT)
- Fire protection corresponding to UL 94-V0

Colour:

- RAL 7035

Supply includes:

- Assembly parts

Packs of	Model No.
3 pc(s).	3079.000



Accessories:

- Punched rail 23 x 23 mm, see page 994



Universal support

for laminated copper bars

For the attachment of multi-stacked laminated copper bars from 5 x 40 x 1 to 10 x 100 x 1 mm.

Material:

- Fibreglass-reinforced, thermoplastic polyester (PBT)
- Fire protection corresponding to UL 94-V0

Colour:

- RAL 7035

Supply includes:

- Assembly parts

Packs of	Model No.
1 pc(s).	3079.010

Note:

- 1 universal support corresponding to the supply scope shown in the photograph



Accessories:

- C rails 30/15, see page 996

RiLine accessories

Contact hazard protection

Base tray

for RiLine busbar systems

For rear contact hazard protection of the busbar assembly.

Material:

- Thermally modified hard PVC.
- Fire protection corresponding to UL 94-V0

Colour:

- RAL 7035

Note:

- May be cut individually to required length

Approvals:

- UL

For system Flat copper busbars, 3-pole

Length mm	Packs of	Model No.
500	2 pc(s).	9340.100
700	2 pc(s).	9340.110
900	2 pc(s).	9340.120
1100	2 pc(s).	9340.130
2400	1 pc(s).	9340.170

For system Flat copper busbars, 4-pole

Length mm	Packs of	Model No.
1100	2 pc(s).	9340.134

For system PLS 800, 3-pole

Length mm	Packs of	Model No.
500	2 pc(s).	9341.100
700	2 pc(s).	9341.110
900	2 pc(s).	9341.120
1100	2 pc(s).	9341.130
2400	1 pc(s).	9341.170

For system PLS 1600, 3-pole

Length mm	Packs of	Model No.
500	2 pc(s).	9342.100
700	2 pc(s).	9342.110
900	2 pc(s).	9342.120
1100	2 pc(s).	9342.130
2400	1 pc(s).	9342.170

For system PLS 1600, 4-pole

Length mm	Packs of	Model No.
1100	2 pc(s).	9342.134



Power distribution

Base tray infill

for RiLine busbar systems

For rear contact hazard protection when connecting the busbars from enclosure to enclosure.

Material:

- Thermally modified hard PVC.
- Fire protection corresponding to UL 94-V0

Colour:

- RAL 7035

Supply includes:

- Assembly parts

Approvals:

- UL

For system	Length mm	Packs of	Model No.
Flat copper busbars, 3-pole	100	2 pc(s).	9340.140
PLS 800, 3-pole	100	2 pc(s).	9341.140
PLS 1600, 3-pole	100	2 pc(s).	9342.140



RiLine accessories

Contact hazard protection



Cover section

for RiLine busbar systems

For clip-on mounting onto the base tray.

Material:

- Thermally modified hard PVC.
- Fire protection corresponding to UL 94-V0

Colour:

- RAL 7035

Note:

- If the cover section is loaded from the front, the support panel is needed for stability
- May be cut individually to required length

Approvals:

- UL

For system	Length mm	Packs of	Model No.
Flat copper busbars, 3-pole PLS 800, 3-pole PLS 1600, 3-pole	700	2 pc(s).	9340.200
Flat copper busbars, 3-pole PLS 800, 3-pole PLS 1600, 3-pole	1100	2 pc(s).	9340.210
Flat copper busbars, 4-pole PLS 1600, 4-pole	1100	2 pc(s).	9340.214



Also required:

- Base tray, see page 347



Accessories:

- Support panel, see page 348

Support panel

for cover section

To prevent side access to the cover section. The support panel also provides additional stability. Recommended mounting distance ≤ 500 mm.

Material:

- Polyamide
- Fire protection corresponding to UL 94-V0

Colour:

- RAL 7035

Approvals:

- UL

For system	Packs of	Model No.
3-pole	5 pc(s).	9340.220
4-pole	5 pc(s).	9340.224

Cross member

for RiLine busbar connections

To comply with the clearances required for "feeder circuits" under UL 508. For flat bar systems with 60 mm bar centre distance and PLS 800/1600.

Material:

- Polyamide
- Fire protection corresponding to UL 94-V0

Colour:

- RAL 7035

Note:

- 2 cross members are required for one busbar connection

Approvals:

- UL

For system	Length mm	Packs of	Model No.
3-pole	160	2 pc(s).	9340.230



Also required:

- Support panel, see page 348

RiLine accessories

Connection systems

Conductor connection clamps

Push-in

Applications:

- For use as busbar pick-off of L, N or PE conductors in switchgear and controlgear, and as a conductor connection clamp in meter boxes.
- For mounting on E-Cu or CUPONAL busbars

Benefits:

- Maintenance-free
- Time-saving top-mounting
- Terminal box with integral label panels
- Universal conductor connection

Functions:

- Fully insulated terminal for tool-free conductor connection
- Conductor is released by the integral release pin

Material:

- Polyamide
- Fire protection corresponding to UL 94-V0

Colour:

- RAL 7042

Basis of test:

- IEC 60 999-1
- IEC 60 947-7-1/-2



For bar thickness mm	Connection of round conductors, single-wire mm ²	Connection of round conductors, multi-wire mm ²	Connection of round conductors, fine wire without wire end ferrule mm ²	Connection of round conductors, fine wire with wire end ferrule mm ²	Packs of	Model No.
5	0.5 - 6	0.5 - 4	0.5 - 4	0.5 - 4	10 pc(s).	3450.505
5	1.5 - 16	1.5 - 16	1.5 - 16	1.5 - 16	10 pc(s).	3451.505
10	0.5 - 6	0.5 - 4	0.5 - 4	0.5 - 4	10 pc(s).	3455.505
10	1.5 - 16	1.5 - 16	1.5 - 16	1.5 - 16	10 pc(s).	3456.505

Conductor connection clamps

For connecting round conductors and laminated copper bars.

Note:

- Wire end ferrules should be used with fine wire conductors

Approvals:

- UR

Accessories:

- Laminated copper bar, see page 346



For bar thickness mm	Connection of round conductors mm ²	Clamping area for laminated copper bars (W x H) mm	Material	Surface finish	Packs of	Model No.
5	1 - 4	-	Sheet steel	Zinc-plated, passivated	15 pc(s).	3450.500
5	2.5 - 16	8 x 8	Sheet steel	Zinc-plated, passivated	15 pc(s).	3451.500
5	16 - 50	10.5 x 11	Sheet steel	Zinc-plated, passivated	15 pc(s).	3452.500
5	35 - 70	16.5 x 15	Sheet steel	Zinc-plated, passivated	15 pc(s).	3453.500
5	70 - 185	22.5 x 20	Sheet steel	Zinc-plated, passivated	15 pc(s).	3454.500
10	1 - 4	-	Sheet steel	Zinc-plated, passivated	15 pc(s).	3455.500
10	2.5 - 16	8 x 8	Sheet steel	Zinc-plated, passivated	15 pc(s).	3456.500
10	16 - 50	10.5 x 11	Sheet steel	Zinc-plated, passivated	15 pc(s).	3457.500
10	35 - 70	16.5 x 15	Sheet steel	Zinc-plated, passivated	15 pc(s).	3458.500
10	70 - 185	22.5 x 20	Sheet steel	Zinc-plated, passivated	15 pc(s).	3459.500
3 - 5	1 - 4	-	Brass	-	15 pc(s).	3550.000
6 - 10	1 - 4	-	Brass	-	15 pc(s).	3555.000

RiLine accessories

Connection systems



Plate clamps

For connecting laminated copper bars; no drilling required.

Material:

- Sheet steel

Surface finish:

- Zinc-plated, passivated

For busbar mm	Clamping area for laminated copper bars (W x H) mm	Packs of	Model No.
12 x 5 - 30 x 10	34 x 10	3 pc(s).	3554.000
40 x 10	34 x 10	3 pc(s).	3559.000
50 x 10	34 x 10	3 pc(s).	3560.000
50 x 10	54 x 10	3 pc(s).	3562.000
60 x 10	34 x 10	3 pc(s).	3561.000
60 x 10	54 x 10	3 pc(s).	3563.000
80 x 10	65 x 10	3 pc(s).	3460.500



Accessories:

- Laminated copper bar, see page 346



System cover

For conductor connection clamps and plate clamps.

Material:

- ABS
- Fire protection corresponding to UL 94-V0

Colour:

- RAL 7035

Note:

- For 3-pole systems with 60/100 mm bar centre distance
- Only suitable for use with systems without a base tray
- For systems with a base tray, the system covers must be mechanically shortened

Approvals:

- UR

Width mm	Depth mm	Height when mounting on 60 mm busbar systems mm	Height when mounting on 100 mm busbar systems mm	Packs of	Model No.
50	80	230	325	4 pc(s).	3086.000
100	80	230	325	4 pc(s).	3087.000
100	110	230	325	4 pc(s).	3090.000
200	80	230	325	4 pc(s).	3088.000
200	110	230	325	4 pc(s).	3091.000

Connection block

Suitable for busbars 12 x 5 to 30 x 10 mm and PLS 800/1600.

Material:

- Punched section: Polyamide
- Cover: ABS
- Fire protection corresponding to UL 94-V0

Colour:

- RAL 7035

Supply includes:

- 3 terminals including cover

Note:

- When using the terminal on 2-pole busbar systems (SV 9340.040), the terminal must be rotated through 180° for connection to the PE busbar

Approvals:

- UL



Accessories:

- Laminated copper bar, see page 346



Rated current max. A	800	1600
Rated operating voltage V, ~	690, 1~	690, 1~
Rated operating voltage (L1 + L2) V	1000 (DC)	1000 (DC)
Rated operating voltage (L1 + L3) V	1500 (DC)	1500 (DC)
Cable outlet	Top/bottom	Top/bottom
Connection of round conductors, fine wire with wire end ferrule mm ²	95 - 185	-
Connection of round conductors, multi-wire mm ²	95 - 300	-
Clamping area for laminated copper bars with 5 mm bar thickness (W x H) mm	33 x 26	65 x 27
Clamping area for laminated copper bars with 10 mm bar thickness (W x H) mm	33 x 22	65 x 22
Width mm	50	85
Height mm	88	88
Packs of	3 pc(s).	3 pc(s).
Model No.	9342.311	9342.321

RiLine accessories

for OM adaptors/supports/component adaptors



Support rail 35 x 7.5 mm for Mini-PLS component adaptors

Material:

- Sheet steel

Surface finish:

- Zinc-plated

Supply includes:

- Assembly screws and side anti-slip guard

Width mm	Packs of	Model No.
45	10 pc(s).	9320.150
54	10 pc(s).	3548.000



Support rail 35 x 7.5 mm for OM adaptors/supports

Applications:

- For assembly on 55 mm wide OM adaptors/ supports with 10 mm wide insert strips mounted on the right and left
- Arrangement of the mounting hole for central configuration on 55 mm wide adaptor section or support frame

Material:

- Sheet steel

Surface finish:

- Zinc-plated

Supply includes:

- Assembly screws and side anti-slip guard

Width mm	Packs of	Model No.
72	5 pc(s).	9342.980



Support rail 35 x 10 mm for OM adaptors/supports

For attaching to the adaptor section and support frame.

Material:

- Polyamide

Colour:

- RAL 9005

Supply includes:

- Assembly screws

Note:

- UL approval in conjunction with OM adaptors/ supports
- Support rail TS xxD-V only suitable for non-pitch pattern-dependent mounting on support frame

Width mm	With anti-slip guard for motor circuit-breaker	Design	Packs of	Model No.
45	■	TS 45C	5 pc(s).	9342.850
45	-	TS 45D	5 pc(s).	9342.860
45	-	TS 45D-V	5 pc(s).	9342.870
55	■	TS 55C	5 pc(s).	9342.920
55	-	TS 55D	5 pc(s).	9342.930
55	-	TS 55D-V	5 pc(s).	9342.940



Support rail 35 x 15 mm for OM adaptors/supports

For attaching to the adaptor section.

Material:

- Sheet steel

Surface finish:

- Zinc-plated

Supply includes:

- Assembly screws and side anti-slip guard

Width mm	Packs of	Model No.
45	5 pc(s).	9342.880
55	5 pc(s).	9342.950

RiLine accessories

for OM adaptors/supports/component adaptors

Support rail 35 x 15 mm

for Mini-PLS/circuit-breaker component adaptors

Material:

- Sheet steel

Surface finish:

- Zinc-plated

Supply includes:

- Assembly screws and side anti-slip guard

Approvals:

- UR

Width mm	To fit Model No.	Packs of	Model No.
72	9342.400/ 9342.410/ 9629.000	5 pc(s).	9320.120



Insert strip

for Mini-PLS component adaptors

To extend the construction width.

Material:

- ABS

Colour:

- RAL 7035

Approvals:

- UR

Width mm	Packs of	Model No.
9	2 pc(s).	9623.000



Insert strip

for OM adaptors/supports

To extend the construction width in a 10 mm pitch pattern. May be bayed as often as required on both sides. With integral cable duct.

Material:

- Polyamide

Colour:

- RAL 7035

Supply includes:

- 6 connection pins

Approvals:

- UL

Width mm	Packs of	Model No.
10	2 pc(s).	9340.290



Insert strip

for circuit-breaker component adaptors

To extend the construction width from 140 mm to 190 mm.

Material:

- ABS

Colour:

- RAL 7035

Supply includes:

- Connection parts for power circuit-breaker, brand Siemens VL630 (3-pole)

Note:

- 4 pieces are needed to widen a component adaptor

Approvals:

- UL

Width mm	To fit Model No.	Packs of	Model No.
25	9345.700/ 9345.710/ 9345.720/ 9345.730	4 pc(s).	9342.720

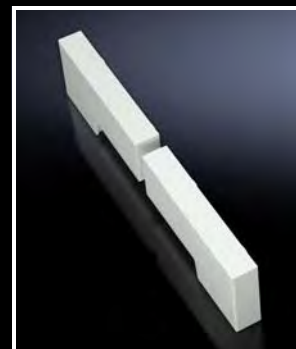

RiLine accessories

for OM adaptors/supports/component adaptors



Connection pin

for OM adaptors/supports

For any required mechanical connection of OM adaptors/supports and insert strip 9340.290.

Material:
– Polyamide

Colour:
– RAL 5010

Approvals:
– UL

Packs of	Model No.
20 pc(s).	9340.280

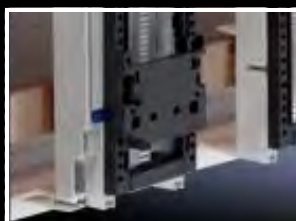

PinBlock

for support frames

For reliable attachment and positioning of the contactor on motor starter combinations. Simple clip-on mounting onto the support frame. Individual vertical positioning is achieved by relocating the PinBlock.

Material:
– Polyamide

Colour:
– RAL 9005

Note:
– UL approval in conjunction with OM adaptors/supports

For support frame width mm	Packs of	Model No.
45	5 pc(s).	9342.800
55	5 pc(s).	9342.810

+ Accessories:

– PinBlock Plus, see page 354



PinBlock Plus

for starters with increased contactor attachment

Mounted by simply clipping onto the PinBlock 9342.800/.810.

Material:
– Polyamide

Colour:
– RAL 9005

Note:
– UL approval in conjunction with OM adaptors/supports

Packs of	Model No.
5 pc(s).	9342.820



Cable set

for OM adaptors with spring terminal block

Pre-assembled connection cables for individual connection of switchgear, top-mounted on OM adaptors with tension spring clamps.

Material:
– PVC insulation
– Temperature resistant to 105 °C
– Wire ends with ultrasonic wire-end compression at both ends

Note:
– AWG = American Wire Gauge

Cross-section	Length mm	Packs of	Model No.
AWG 14 = 2.08 mm ² ± 2,5 mm ²	140	15 pc(s).	9340.850
AWG 12 = 3.31 mm ² ± 4 mm ²	140	15 pc(s).	9340.860
AWG 10 = 5.26 mm ² ± 6 mm ²	140	15 pc(s).	9340.870
AWG 8 = 8.37 mm ² ± 10 mm ²	140	6 pc(s).	9340.880
AWG 6 = 13.3 mm ² ± 16 mm ²	140	6 pc(s).	9340.890

RiLine accessories

for OM adaptors/supports/component adaptors

Twin cord

for OM adaptors with spring terminal block 2.5 – 16 mm²

Pre-assembled connection cables for individual connection of up to two switchgear units per adaptor.

Material:

- PVC insulation
- Temperature resistant to 105 °C
- Wire ends with ultrasonic wire-end compression at both ends

Note:

- AWG = American Wire Gauge

Cross-section	Length mm	Packs of	Model No.
AWG 10 = 5.26 mm ² ± 6 mm ²	140 250	6 pc(s).	9340.820
AWG 8 = 8.37 mm ² ± 10 mm ²	140 250	6 pc(s).	9340.830



Sliding block

for circuit-breaker component adaptors

For additional locking of circuit-breakers with more than two attachment points.

Colour:

- RAL 7035

Note:

- UL approval in conjunction with circuit-breaker component adaptor

To fit Model No.	With threaded insert	Packs of	Model No.
9342.500/9342.510/ 9342.504/9342.514/ 9342.540/9342.550	M3 M4	6 pc(s).	9342.560
9345.600/9345.610/ 9345.604/9345.614	M4 M5	6 pc(s).	9342.640



Connection bracket

for circuit-breaker component adaptors

Pre-assembled, laminated flat copper for connecting standard, commercially available moulded case circuit-breakers (MCCB).

Material:

- Electrolytic copper F20

Note:

- Universal application for switchgear with a dimensional difference between the mounting level and the upper edge of the contact level of 20 ± 5 mm.

For switchgear make (model)	To fit Model No.	Number of lamina	Membrane width mm	Membrane thickness mm	Packs of	Model No.
ABB (T1, T1 UL, T2, T2 UL) Eaton (NZM1, NZM1 UL, BZM B1) Schneider Electric (NSC100, NSE75, NSE100)	9342.500/ 9342.510/ 9342.540/ 9342.550	6	9	0.8	3 pc(s).	9342.570



RiLine accessories

for bus-mounting fuse bases



Contact hazard protection cover plate

for bus-mounting fuse bases

The cover ensures contact hazard protection from the front, top and below. All-round contact hazard protection (up to IP 2X) in conjunction with the side cover 3093.010/.020.

Material:

- Polyamide
- Fire protection corresponding to UL 94-V0

Colour:

- RAL 7035

To fit Model No.	Fuse inserts	Packs of	Model No.
3418.010	D 02-E 18	10 pc(s).	3418.020
3427.010	D II-E 27	10 pc(s).	3427.020
3433.010	D III-E 33	10 pc(s).	3433.020



Cover, side

for bus-mounting fuse bases

For clip-on mounting onto the cover plate, contact hazard protection.

Material:

- Polyamide
- Fire protection corresponding to UL 94-V0

Colour:

- RAL 7035

To fit Model No.	Fuse inserts	Packs of	Model No.
3418.010	D 02-E 18	10 pc(s).	3093.010
3427.010/ 3433.010	D II-E 27 D III-E 33	10 pc(s).	3093.020



Connection space extender

for bus-mounting fuse bases

Contact hazard protection cover plate including cable duct for side extension of the connection space by 14 mm.

Material:

- Polyamide
- Fire protection corresponding to UL 94-V0

Colour:

- RAL 7035

To fit Model No.	Fuse inserts	Packs of	Model No.
3418.010	D 02-E 18	10 pc(s).	3418.030
3427.010	D II-E 27	10 pc(s).	3427.030
3433.010	D III-E 33	10 pc(s).	3433.030

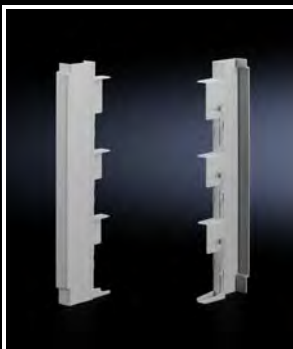

Wiring duct

for D-Switch bus-mounting fuse base

For safe, shock-hazard-protected routing of connection cables. Also suitable for use as a spacer support.

Material:

- Polyamide
- Fire protection corresponding to UL 94-V0

Colour:

- RAL 7035

Width mm	To fit Model No.	Packs of	Model No.
13.5	9340.950	10 pc(s).	9340.905

RiLine accessories

for NH fuse elements

Box terminal

for NH fuse-switch disconnectors

For direct connection of round and sector-shaped conductors and laminated copper bars. Suitable for NH fuse-switch disconnectors with screw terminal.

Material:

– Cast brass

Surface finish:

– Nickel-plated

For size	Connection of round conductors mm ²	Connection of sector-shaped conductors mm ²	Clamping area for laminated copper bars (W x H) mm	Packs of	Model No.
1	35 - 150	50 - 150	20 x 14	3 pc(s).	9344.610
2/3	95 - 300	120 - 300	32 x 20	3 pc(s).	9344.620



Arcing chamber

for NH fuse-switch disconnectors

To increase switching capacity (utilisation category).

For size	Packs of	Model No.
1 - 3	3 pc(s).	9344.680

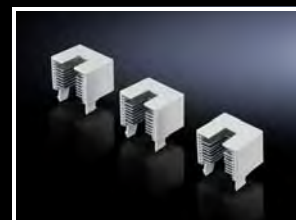

Connection space cover

for NH fuse-switch disconnectors

For extending the contact hazard protection cover, e.g. when using ring terminals with a long collar. Bayable as required at the top and bottom.

Material:

– Polyamide

Colour:

– RAL 7035

For size	Packs of	Model No.
00	2 pc(s).	9344.520
1	2 pc(s).	9344.530
2	2 pc(s).	9344.540
3	2 pc(s).	9344.550



Connection space cover

for NH slimline fuse-switch disconnectors

Extended version for the use of ring terminals with a long collar.

Material:

– Polycarbonate

For size	Packs of	Model No.
00	1 pc(s).	9346.460

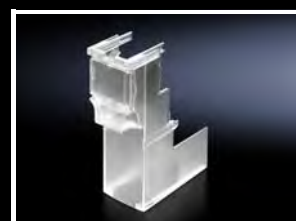

RiLine accessories

for NH fuse elements

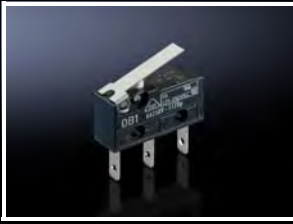

Micro-switch

for NH fuse-switch disconnectors/NH slimline fuse-switch disconnectors (185 mm)

To indicate the switch position of the NH unit (cover).

For size	Rated operating current max. A	Rated operating voltage V	Product-specific scope of supply	Packs of	Model No.
NH fuse-switch disconnectors, size 000/00 NH slimline fuse-switch disconnectors, size 00 - 3 (185 mm)	5	250	-	5 pc(s).	3071.000
NH fuse-switch disconnectors, size 1 - 3	5	250	Including plastic lug for attaching the micro-switch to the disconnectors chassis	2 pc(s).	9344.510

Micro-switch

for NH slimline fuse-switch disconnectors

To indicate the switch position of the NH unit (cover).

For size	Rated operating current max. A	Rated operating voltage V	Packs of	Model No.
00	5	250	5 pc(s).	9346.400

Clamp-type terminal connection

for NH slimline fuse-switch disconnectors

For the connection of round conductors. Suitable for NH slimline fuse-switch disconnectors with screw terminal.

Material:

- Cast brass

Surface finish:

- Nickel-plated

For size	Connection of round conductors mm ²	Packs of	Model No.
00	1.5 - 95	3 pc(s).	3592.010

Push-in conductor connection clamps

Simple, tool-free cable connection, see page 349

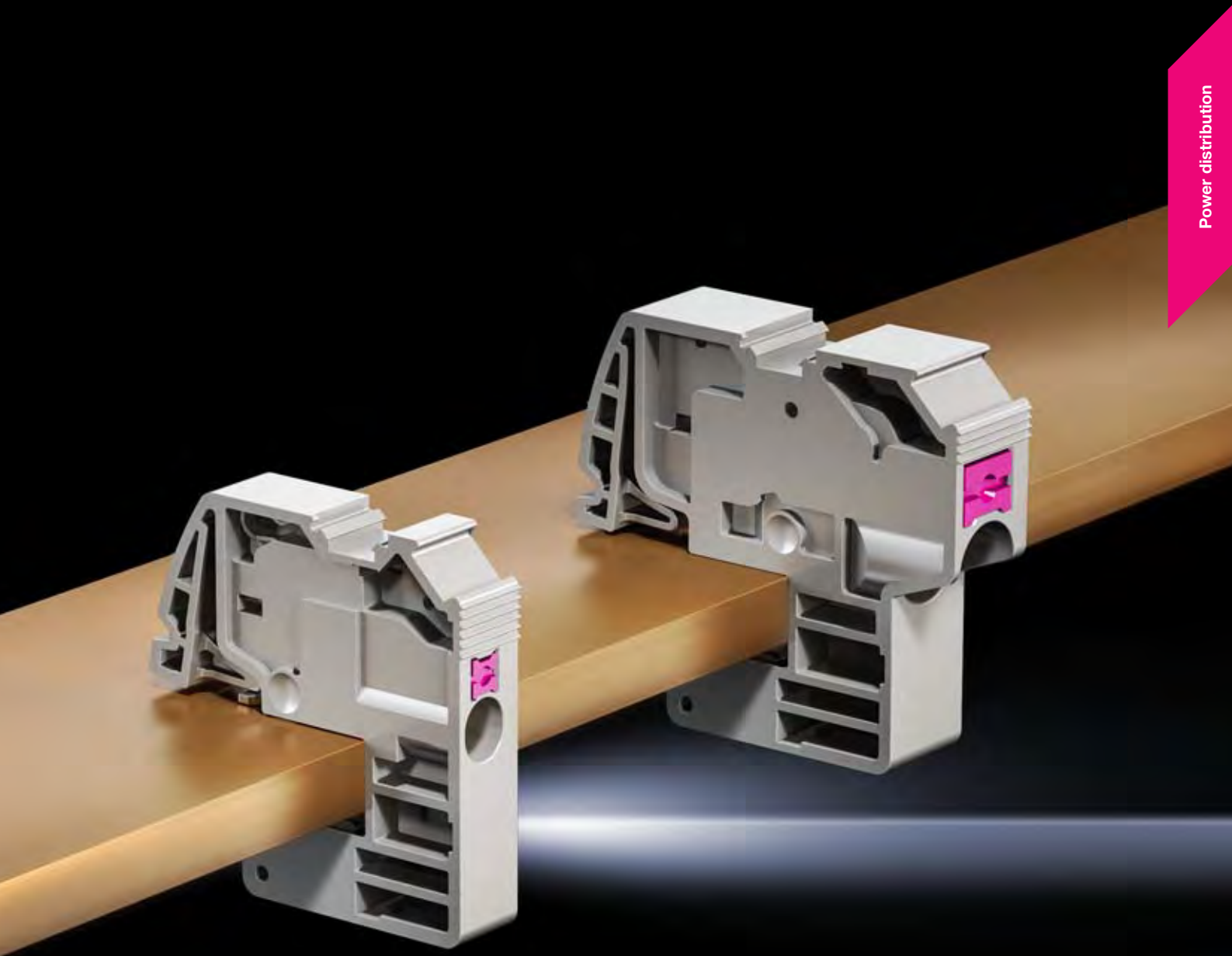

Rittal – The System.

Faster – better – everywhere.



VX25 Ri4Power

Busbar systems

Ri4Power busbar system (185 mm)	368
Busbar systems (100/185/150 mm)	388
Flat-PLS	394
Maxi-PLS	401

Connection system

Flat-PLS	398
Maxi-PLS	403
Accessories – connection components	405
Connection components	406

Cover systems

Form 1	408
Form 2b	409

Compartment configuration

Form 1-4	410
----------------	-----

Fuse-switch disconnecter section

Busbar end supports	415
Cover	415
Ri4Power accessories	417
ISV distribution enclosures	419

Baying enclosure system VX25

Modular enclosures	132
Fuse-switch-disconnector enclosures	134
Distribution enclosures	135
ISV installation kits	420
ISV installation modules	421
ISV accessories	428
Installation accessories for modular front design	926



VX25 Ri4Power system 185 mm – System assembly without drilling

The busbar system is quickly and conveniently installed in the enclosure in just three steps:

- Position the punched section with mounting flange and system attachment in the enclosure
- Secure the busbar assembly
- Clip the cover system into position

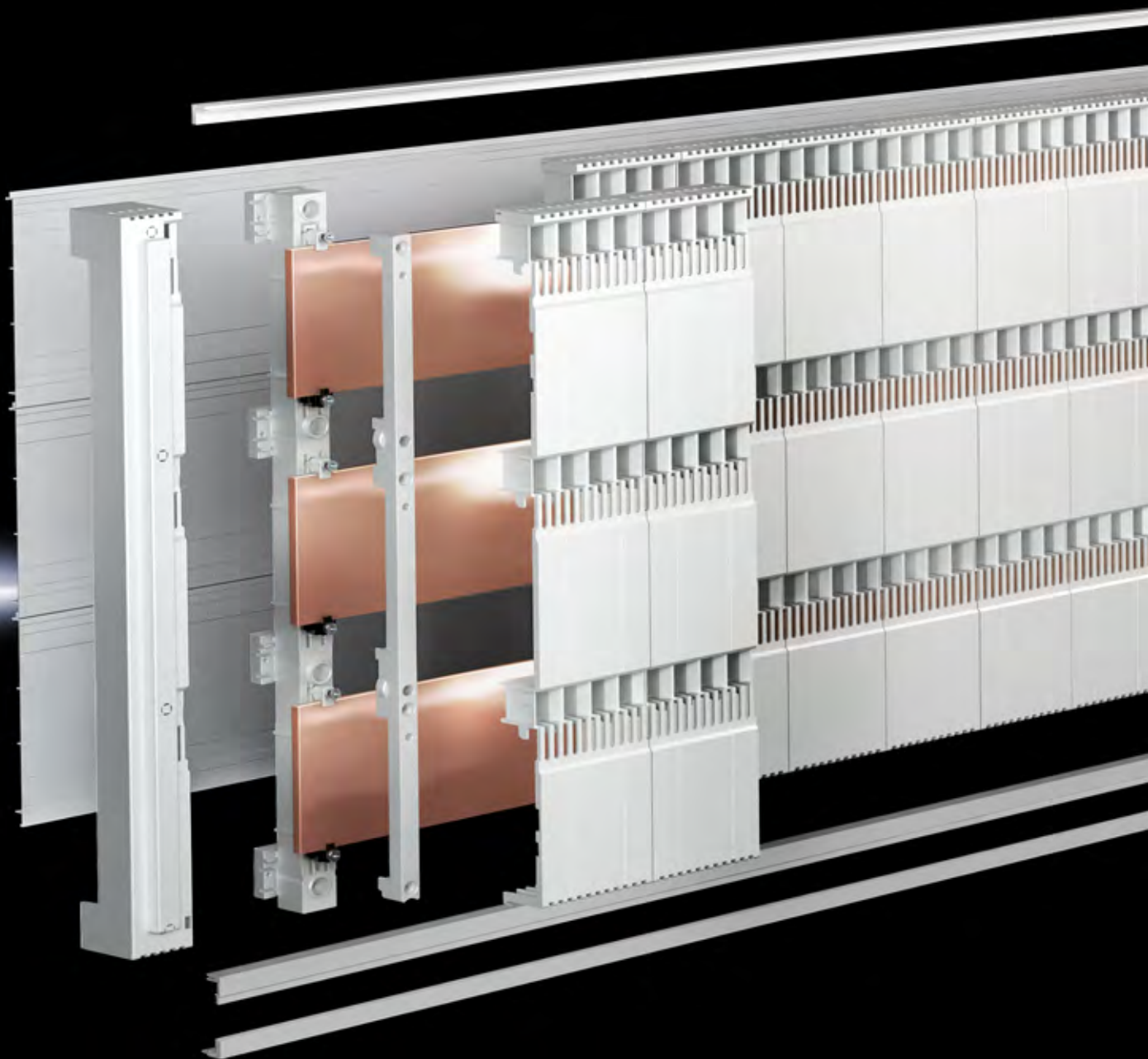

Busbar support

- For busbar dimensions ranging from 40 x 10 to 120 x 10 mm
- The support may be top-mounted with components using the pitch pattern of the cover system
- Rated short-time withstand current I_{cw} up to 50 kA
- Rated busbar currents of up to 2100 A
- Mounting via system attachment in the VX25 baying enclosure system, no drilling required



Power distribution

Cover section

- Contact hazard protection up to IP 2XB (safe from finger-contact)
- Integral busbar shielding to prevent accidental arcing
- Secure positioning of the top-mounting components, thanks to centring device
- New contact system allows components to be top-mounted on the cover section
- Components are easily retrofitted without removing the cover section



Base tray

- For rear contact hazard protection of the busbar assembly
- For optimum all-round contact hazard protection in conjunction with the cover section
- Prepared ready to install, fits VX25 baying enclosure system widths from 600 mm to 1200 mm



The perfect-fit adaptor system

Connection and component adaptors for tested, safe connection at high currents

- For air circuit-breakers up to 630 A and 1600 A
- Direction connection of various conductor types
- No-drill connection system to the busbar



Busbar connection adaptors and connection blocks

- Compact, fast connection of cables and lines
- Suitable for various types of conductor
- With standardised contact hazard protection cover plates

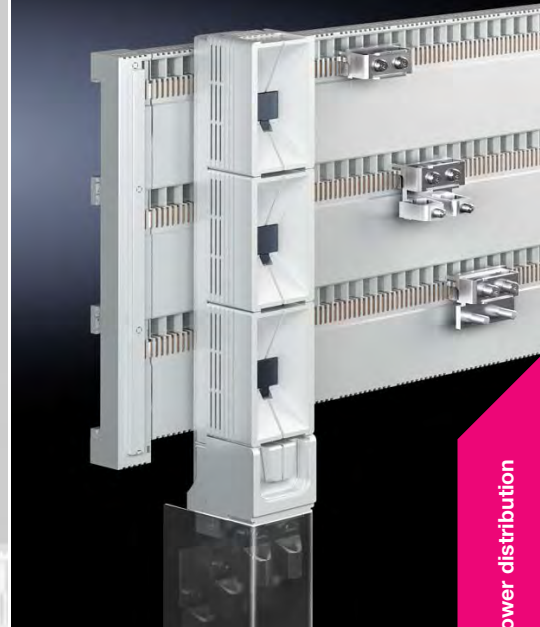

Power distribution

Component adaptors for compact circuit-breakers

- Two sizes up to 630 A and 1600 A
- Variants for clamping or screw attachment
- Make contact without drilling
- Ideal for incoming and outgoing circuits

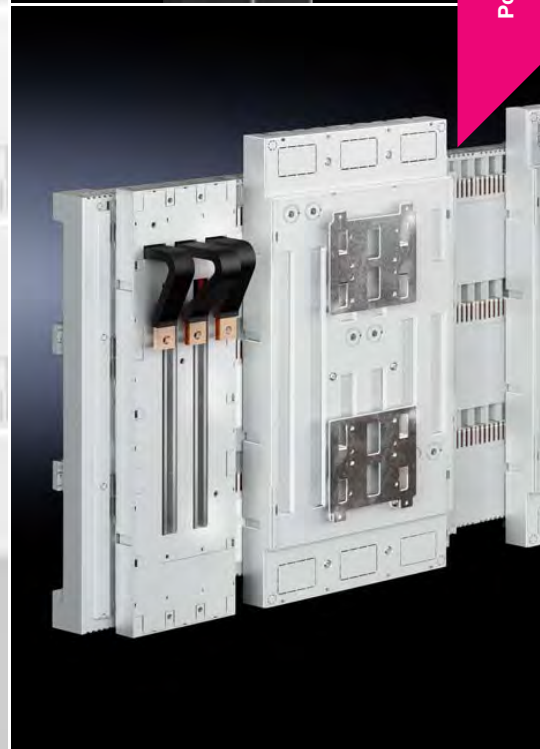

Connector kit and transformer

- Form-fit, prepared for switch brands ABB, Eaton, Schneider Electric, Siemens
- Preassembled connector kits from the adaptor to the circuit-breaker
- Optional integration of a current transformer
- Complete contact hazard protection in the inlet and outlet zones



Fuse elements to suit all situations

The new system of NH slimline fuse-switch disconnectors is based on separate air routing for heat dissipation and targeted removal of switching gases, while the NH slimline switch-disconnectors ensure user-independent disconnection and switching for enhanced safety.

- Simple device assembly
- Safe operation
- Optimum contact hazard protection

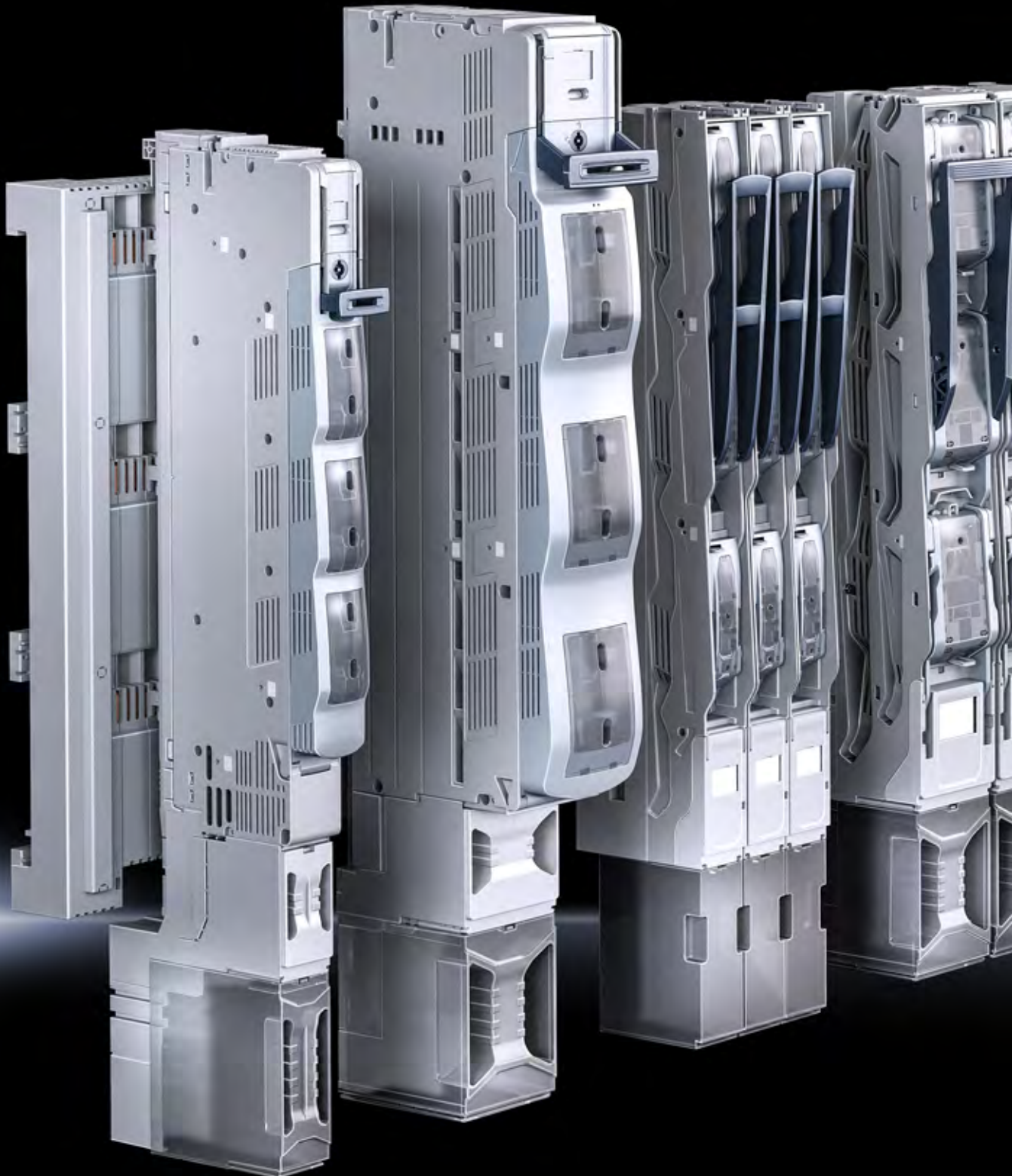

NH slimline fuse-switch disconnectors, sizes 00 to 3

- Single-pole and 3-pole switchable variants
- Symmetrical layout for cable outlet at the top and bottom
- Optional integration of current transformers
- Versions with and without fuse monitoring
- Self-closing voltage testing holes
- Prepared for multiple lead seals
- Hinged terminal cover
- Cascadable connection space extension
- Simple conversion of the bolt or screw connections
- Contact hazard-proof fuse contacts with the top section dismantled
- Optional micro-switch monitoring of the cover switch position

NH slimline switch-disconnectors, size 00 to 3

- Disconnect and switch with one device
- Integral, user-independent quick-break contact ensures safe operation
- User-friendly cable connection from above or below
- Versions with and without fuse monitoring
- Integral switch position display
- No-drill contacting with clamping screw attachment
- Double-break allows de-energised fuse replacement

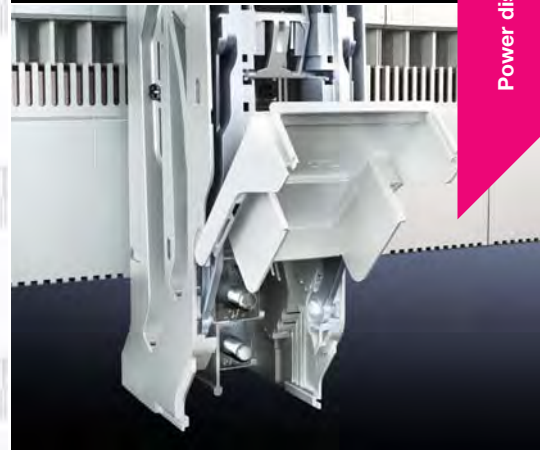
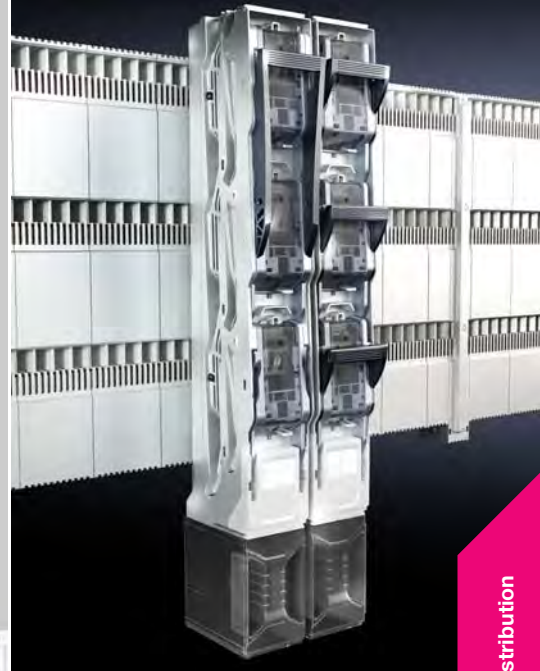

Power distribution

Busbar support (185 mm)



Connection adaptors Page 370 **Connection block** Page 371 **Component adaptors** Page 372 **NH slimline switch-disconnectors** Page 374

Material:

- Polyamide
- Fire protection corresponding to UL 94-V0

Supply includes:

- Including assembly components for contact hazard protection cover (base tray)

Colour:

- RAL 7035

			
Bar centre distance mm	Packs of	185	Page
Rated operating voltage V, ~		1000, 3-1500 (DC)	
Number of poles		3-pole	
For busbar mm		40 x 10 60 x 10 80 x 10 100 x 10 120 x 10	
Model No.	2 pc(s).	9677.500	
Accessories			
Busbars E-Cu		see page	369
Contact hazard protection cover plate		see page	381
End cover	2 pc(s).	9677.600	380

Busbar system 185 mm

Busbar supports

Note:

Required quantity when using in the enclosure width
 – 600/800 mm: 2 pc(s).
 – 1000/1200 mm: 3 pc(s).



Number of poles	Packs of	3-pole	Page
Bar centre distance mm		185	
Model No.	2 pc(s).	9677.500	368

Busbars E-Cu, length: 2400 mm/bar

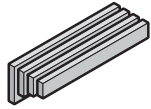

Dimensions mm	Packs of	Model No.	Page
40 x 10	3 pc(s).	3587.000	342
60 x 10	2 pc(s).	3589.005	
80 x 10	1 pc(s).	3590.005	
100 x 10	1 pc(s).	3590.015	
120 x 10	1 pc(s).	3590.020	

Accessories

Busbar connector		see page	380
------------------	--	----------	-----

System attachment



For enclosure width mm	Packs of	Model No.	Page
600	1 pc(s).	9677.511	380
800	1 pc(s).	9677.521	
1000	1 pc(s).	9677.531	
1200	1 pc(s).	9677.541	

Accessories

Punched section with mounting flange, 23 x 64 mm

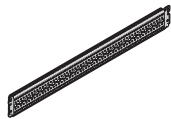

For enclosure depth mm	Packs of	Model No.	Page
500	4 pc(s).	8617.120	991
600	4 pc(s).	8617.130	
800	4 pc(s).	8617.140	

Contact hazard protection

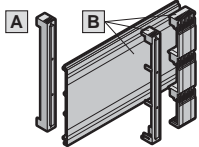

Components	For enclosure width mm	Packs of	Model No.	Page
A End covers l/r	–	2 pc(s).	9677.600	381
B Cover plate, contact hazard protection (cover section, base tray, trim section)	600	1 pc(s).	9677.550	
	800	1 pc(s).	9677.560	
	1000	1 pc(s).	9677.570	
	1200	1 pc(s).	9677.580	

Connection adaptors



Busbar system Page 368 **Connection block** Page 371 **Component adaptors** Page 372 **NH slimline switch-disconnectors** Page 374

Material:

- Chassis: Fibreglass-reinforced polyester
- Fire protection corresponding to UL 94-V0

Note:

- When using components on busbars with contact hazard protection cover, the contact terminal must be used

Colour:

- RAL 7035

Rated current max. 800 – 1400 A

Rated current max. A	Packs of	800	1400	Page
Rated operating voltage V, ~		690, 3~	690, 3~	
Number of poles		3-pole	3-pole	
Cable outlet		Top/bottom	Top/bottom	
Type of connection		Screw M12	Screw M12	
Connection of round conductors mm ²		6 - 240	6 - 300	
Width mm		100	100	
Height mm		665	960	
For bar systems with centre-to-centre spacing mm		185	185	
For bar thickness mm		10	10	
Model No.	1 pc(s).	9677.900	9677.905	
Product-specific scope of supply				
Contact hazard protection cover plate		-	■	
Accessories				
Contact terminal	3 pc(s).	9677.460	9677.460	383
Busbar terminal	3 pc(s).	9677.480	9677.480	384



Busbar system Page 368 **Connection adaptors** Page 370 **Component adaptors** Page 372 **NH slimline switch-disconnectors** Page 374

For connecting cables and laminated copper bars.

Material:

- Sheet steel, zinc-plated
- E-Cu, tin-plated

Rated current max. 1000 – 1600 A

Rated current max. A	Packs of	1000	1600	1600	Page
Rated operating voltage V, ~		690, 1~	690, 1~	690, 1~	
Cable outlet		Top/bottom	Top/bottom	Top/bottom	
Type of connection		Box terminal	-	Ring terminal M12	
Number of connection cables max.		2	-	4	
Connection of round conductors mm ²		185 - 300	-	240	
Clamping area for laminated copper bars (W x H) mm		-	80 x 20	-	
Width mm		98	98	98	
For bar thickness mm		10	10	10	
Model No.	1 pc(s).	9677.915	9677.910	9677.920	

Also required

Contact hazard protection cover plate	1 pc(s).	9677.925	9677.925	9677.925	382
---------------------------------------	----------	----------	----------	----------	-----

Component adaptors



Busbar system Page 368 **Connection adaptors** Page 370 **Connection block** Page 371 **NH slimline switch-disconnectors** Page 374

Material:

- Polyamide
- Fire protection corresponding to UL 94-V0

Colour:

- RAL 7035

Note:

- Cable outlet: Switch outlet or as outgoing cable from the switchgear
- Suitable for the use of switchgear with front screw terminal
- For mounting on busbar systems with or without cover section

Rated current max. 630 – 1600 A, clamping attachment

Rated current max. A	Packs of	630	1000	1600	Page
Rated operating voltage V, ~		690, 3~	690, 3~	690, 3~	
Number of poles		3-pole	3-pole	3-pole	
Installation type		Clamping attachment	Clamping attachment	Clamping attachment	
Cable outlet		Bottom	Bottom	Bottom	
For switchgear make (model)		ABB (Tmax T5) Eaton (NZM3) Schneider Electric (NSX630) Siemens (3VA23, 3VA24, 3VL4)	ABB (Tmax T7 - 800 A/1000 A) Eaton (NZM4 - 800 A/1000 A) Schneider Electric (NS - 800 A/1000 A) Siemens (VL1250/3VL7 - 1000 A)	ABB (Tmax T7 - 1250 A/1600 A) Eaton (NZM4 - 1250 A/1600 A) Schneider Electric (NS - 1250 A/1600 A) Siemens (VL1250/3VL7 - 1250 A, VL1600/3VL8 - 1600 A)	
Width mm		150	300	300	
Height mm		585	652	652	
For bar systems with centre-to-centre spacing mm		185	185	185	
For bar thickness mm		10	10	10	
Model No.	1 pc(s).	9677.770	9677.700	9677.710	
Product-specific scope of supply					
Connection straps		■	-	-	
Also required					
Connector kit		-	see page	see page	382
Contact hazard protection cover plate		-	see page	see page	382



Busbar system Page 368 **Connection adaptors** Page 370 **Connection block** Page 371 **NH slimline switch-disconnectors** Page 374

Material:

- Polyamide
- Fire protection corresponding to UL 94-V0

Colour:

- RAL 7035

Note:

- Cable outlet: Switch outlet or as outgoing cable from the switchgear
- Suitable for the use of switchgear with front screw terminal
- For attaching to busbars with holes. Please ensure that there is no cover section installed in the vicinity of the device.

Rated current max. 630 – 1600 A, screw attachment

Rated current max. A	Packs of	630	1000	1600	Page
Rated operating voltage V, ~		690, 3~	690, 3~	690, 3~	
Number of poles		3-pole	3-pole	3-pole	
Installation type		Screw attachment	Screw attachment	Screw attachment	
Cable outlet		Bottom	Bottom	Bottom	
For switchgear make (model)		ABB (Tmax T5) Eaton (NZM3) Schneider Electric (NSX630) Siemens (3VA23, 3VA24, 3VL4)	ABB (Tmax T7 - 800 A/1000 A) Eaton (NZM4 - 800 A/1000 A) Schneider Electric (NS - 800 A/1000 A) Siemens (VL1250/3VL7 - 1000 A)	ABB (Tmax T7 - 1250 A/1600 A) Eaton (NZM4 - 1250 A/1600 A) Schneider Electric (NS - 1250 A/1600 A) Siemens (VL1250/3VL7 - 1250 A, VL1600/3VL8 - 1600 A)	
Width mm		150	300	300	
Height mm		585	652	652	
For bar systems with centre-to-centre spacing mm		185	185	185	
For bar thickness mm		10	10	10	
Model No.	1 pc(s).	9677.780	9677.705	9677.715	
Product-specific scope of supply					
Connection straps		■	-	-	
Also required					
Connector kit		-	see page	see page	382
Contact hazard protection cover plate		-	see page	see page	382

NH slimline fuse-switch disconnectors



Busbar system Page 368 **Connection adaptors** Page 370 **Connection block** Page 371 **Component adaptors** Page 372

Material:

- Polyamide
- Fire protection corresponding to UL 94-V0
- Contact tracks: Partially silver-plated hard copper

Colour:

- Chassis: RAL 7035
- Cover: RAL 7001
- Handle: RAL 7016

Basis of test:

- IEC/DIN EN 60 947-3
- DIN EN 60 269-2 (fuse inserts)

Note:

- When using components on busbars with contact hazard protection cover, the contact terminal must be used

Size 00 – 3, design single-pole, switchable

Size	Packs of	00	1	2	3	Page
Twin track		–	–	–	–	
Rated operating current max. A		160	250	400	630	
Rated operating voltage V, ~		690, 3~	690, 3~	690, 3~	690, 3~	
Number of poles		3-pole	3-pole	3-pole	3-pole	
Cable outlet		Top/bottom	Top/bottom	Top/bottom	Top/bottom	
Type of connection		Screw M8	Bolt M12	Bolt M12	Bolt M12	
Connection of round conductors mm ²		1.5 - 95	6 - 240	6 - 240	6 - 240	
Width mm		50	100	100	100	
Height mm		670	670	670	670	
For converter installation		■	■	■	■	
For bar systems with centre-to-centre spacing mm		185	185	185	185	
For bar thickness mm		10	10	10	10	
Model No.	1 pc(s).	9677.010	9677.110	9677.210	9677.310	
Accessories						
Connection space cover	1 pc(s).	see page	9677.410	9677.410	9677.410	383
Contact terminal	3 pc(s).	9677.450	9677.460	9677.460	9677.460	383
Busbar terminal	3 pc(s).	9677.470	9677.480	9677.480	9677.480	384
Prism terminal	3 pc(s).	9677.420	–	–	–	384
V connection terminal	3 pc(s).	–	9677.430	9677.430	9677.440	384
Current converter	1 pc(s).	9677.810	see page	see page	see page	385
Cover	5 pc(s).	–	9677.415	9677.415	9677.415	385
Trim strip	2 pc(s).	9677.407	9677.407	9677.407	9677.407	386
Micro-switch	5 pc(s).	3071.000	3071.000	3071.000	3071.000	358

NH slimline fuse-switch disconnectors

Size 00 – 1, design 3-pole, switchable

Size	Packs of	00	00	1	Page
Twin track		–	–	–	
Rated operating current max. A		160	160	250	
Rated operating voltage V, ~		690, 3~	690, 3~	690, 3~	
Number of poles		3-pole	3-pole	3-pole	
Cable outlet		Top/bottom	Top/bottom	Top/bottom	
Type of connection		Screw M8	Box terminal	Bolt M12	
Connection of round conductors mm ²		1.5 - 95	1.5 - 95	6 - 240	
Width mm		50	50	100	
Height mm		670	670	670	
For converter installation		■	■	■	
For bar systems with centre-to-centre spacing mm		185	185	185	
For bar thickness mm		10	10	10	
Model No.	1 pc(s).	9677.000	9677.025	9677.100	
Accessories					
Connection space cover	1 pc(s).	see page	see page	9677.410	383
Contact terminal	3 pc(s).	9677.450	9677.450	9677.460	383
Busbar terminal	3 pc(s).	9677.470	9677.470	9677.480	384
Prism terminal	3 pc(s).	9677.420	–	–	384
V connection terminal	3 pc(s).	–	–	9677.430	384
Current converter	1 pc(s).	9677.810	9677.810	see page	385
Cover	5 pc(s).	–	–	9677.415	385
Trim strip	2 pc(s).	9677.407	9677.407	9677.407	386
Micro-switch	5 pc(s).	3071.000	3071.000	3071.000	358

Size 2 – 3, design 3-pole, switchable

Size	Packs of	2	3	3	Page
Twin track		–	–	■	
Rated operating current max. A		400	630	1250	
Rated operating voltage V, ~		690, 3~	690, 3~	690, 3~	
Number of poles		3-pole	3-pole	3-pole	
Cable outlet		Top/bottom	Top/bottom	Bottom	
Type of connection		Bolt M12	Bolt M12	Bolt M12	
Connection of round conductors mm ²		6 - 240	6 - 240	6 - 240	
Width mm		100	100	200	
Height mm		670	670	670	
For converter installation		■	■	■	
For bar systems with centre-to-centre spacing mm		185	185	185	
For bar thickness mm		10	10	10	
Model No.	1 pc(s).	9677.200	9677.300	9677.340	
Accessories					
Connection space cover	1 pc(s).	9677.410	9677.410	–	383
Contact terminal	3 pc(s).	9677.460	9677.460	9677.460	383
Busbar terminal	3 pc(s).	9677.480	9677.480	9677.480	384
Prism terminal		–	–	–	
V connection terminal	3 pc(s).	9677.430	9677.440	–	384
Current converter		see page	see page	see page	385
Cover	5 pc(s).	9677.415	9677.415	–	385
Trim strip	2 pc(s).	9677.407	9677.407	9677.407	386
Micro-switch	5 pc(s).	3071.000	3071.000	3071.000	358

NH slimline fuse-switch disconnectors



Busbar system Page 368 **Connection adaptors** Page 370 **Connection block** Page 371 **Component adaptors** Page 372

Material:

- Polyamide
- Fire protection corresponding to UL 94-V0
- Contact tracks: Partially silver-plated hard copper

Colour:

- Chassis: RAL 7035
- Cover: RAL 7001
- Handle: RAL 7016

Basis of test:

- IEC/DIN EN 60 947-3
- DIN EN 60 269-2 (fuse inserts)

Note:

- When using components on busbars with contact hazard protection cover, the contact terminal must be used

Size 00 – 3, with electronic fuse monitoring

Size	Packs of	00	1	2	3	Page
Design		3-pole, switchable	3-pole, switchable	3-pole, switchable	3-pole, switchable	
Rated operating current max. A		160	250	400	630	
Rated operating voltage V, ~		400, 3~	400, 3~	400, 3~	400, 3~	
Number of poles		3-pole	3-pole	3-pole	3-pole	
Cable outlet		Top/bottom	Top/bottom	Top/bottom	Top/bottom	
Type of connection		Screw M8	Bolt M12	Bolt M12	Bolt M12	
Connection of round conductors mm ²		1.5 - 95	6 - 240	6 - 240	6 - 240	
Width mm		50	100	100	100	
Height mm		830	830	830	830	
For converter installation		■	■	■	■	
For bar systems with centre-to-centre spacing mm		185	185	185	185	
For bar thickness mm		10	10	10	10	
Model No.	1 pc(s).	9677.015	9677.115	9677.215	9677.315	
Accessories						
Connection space cover	1 pc(s).	see page	9677.410	9677.410	9677.410	383
Contact terminal	3 pc(s).	9677.450	9677.460	9677.460	9677.460	383
Busbar terminal	3 pc(s).	9677.470	9677.480	9677.480	9677.480	384
Prism terminal	3 pc(s).	9677.420	-	-	-	384
V connection terminal	3 pc(s).	-	9677.430	9677.430	9677.440	384
Current converter	1 pc(s).	9677.810	see page	see page	see page	385
Cover	5 pc(s).	-	9677.415	9677.415	9677.415	385
Trim strip	2 pc(s).	9677.407	9677.407	9677.407	9677.407	386
Micro-switch	5 pc(s).	3071.000	3071.000	3071.000	3071.000	358

NH slimline switch-disconnectors



Busbar system Page 368 **Connection adaptors** Page 370 **Connection block** Page 371 **Component adaptors** Page 372

Functions:

- Automatic quick-break contact allows operator-independent switching
- Double-break for reliable disconnection of the contacts

Material:

- Polyamide
- Fire protection corresponding to UL 94-V0
- Contact tracks: Partially silver-plated hard copper

Colour:

- Chassis: RAL 7035
- Cover: RAL 7001
- Handle: RAL 7016

Basis of test:

- IEC/DIN EN 60 947-3
- DIN EN 60 269-2 (fuse inserts)

Size 00, design 3-pole, switchable

Size	Packs of	00	00	00	00	Page
Rated operating current max. A		160	160	160	160	
Rated operating voltage V, ~		690, 3~	690, 3~	690, 3~	690, 3~	
Number of poles		3-pole	3-pole	3-pole	3-pole	
Installation type		Clamping attachment	Clamping attachment	Screw attachment	Screw attachment	
Cable outlet		Bottom	Top	Bottom	Top	
Type of connection		Screw M8	Screw M8	Screw M8	Screw M8	
Connection of round conductors mm ²		1.5 - 95	1.5 - 95	1.5 - 95	1.5 - 95	
Width mm		50	50	50	50	
Height mm		676	676	676	676	
For converter installation		■	■	■	■	
For bar systems with centre-to-centre spacing mm		185	185	185	185	
For bar thickness mm		10	10	10	10	
Model No.	1 pc(s).	9677.060	9677.070	9677.065	9677.075	
Accessories						
Connection space cover	1 pc(s).	9677.400	9677.400	9677.400	9677.400	383
Connection space cover, rear	1 pc(s).	9677.402	9677.402	9677.402	9677.402	386
Clamp-type terminal	3 pc(s).	9677.425	9677.425	9677.425	9677.425	386
Box terminal		-	-	-	-	
Contact terminal		-	-	-	-	
Current converter	1 pc(s).	9677.810	9677.810	9677.810	9677.810	385
Trim strip	2 pc(s).	9677.407	9677.407	9677.407	9677.407	386
Micro-switch	1 pc(s).	9677.418	9677.418	9677.418	9677.418	387

NH slimline switch-disconnectors

Size 1 – 2, design 3-pole, switchable

Size	Packs of	1	1	2	Page
Rated operating current max. A		250	250	400	
Rated operating voltage V, ~		690, 3~	690, 3~	690, 3~	
Number of poles		3-pole	3-pole	3-pole	
Installation type		Screw attachment	Screw attachment	Screw attachment	
Cable outlet		Bottom	Top	Bottom	
Type of connection		Screw M12	Screw M12	Screw M12	
Connection of round conductors mm ²		6 - 240	6 - 240	6 - 240	
Width mm		100	100	100	
Height mm		772	772	772	
For converter installation		–	–	–	
For bar systems with centre-to-centre spacing mm		185	185	185	
For bar thickness mm		10	10	10	
Model No.	1 pc(s).	9677.160	9677.165	9677.260	
Accessories					
Connection space cover	1 pc(s).	9677.410	9677.410	9677.410	383
Connection space cover, rear	1 pc(s).	9677.412	9677.412	9677.412	386
Clamp-type terminal		–	–	–	
Box terminal		see page	see page	see page	387
Contact terminal	3 pc(s).	9677.485	9677.485	9677.485	387
Current converter		–	–	–	
Trim strip	2 pc(s).	9677.407	9677.407	9677.407	386
Micro-switch	1 pc(s).	9677.418	9677.418	9677.418	387

Size 2 – 3, design 3-pole, switchable

Size	Packs of	2	3	3	Page
Rated operating current max. A		400	630	500	
Rated operating voltage V, ~		690, 3~	690, 3~	690, 3~	
Number of poles		3-pole	3-pole	3-pole	
Installation type		Screw attachment	Screw attachment	Screw attachment	
Cable outlet		Top	Bottom	Top	
Type of connection		Screw M12	Screw M12	Screw M12	
Connection of round conductors mm ²		6 - 240	6 - 240	6 - 240	
Width mm		100	100	100	
Height mm		772	772	772	
For converter installation		–	–	–	
For bar systems with centre-to-centre spacing mm		185	185	185	
For bar thickness mm		10	10	10	
Model No.	1 pc(s).	9677.265	9677.360	9677.365	
Accessories					
Connection space cover	1 pc(s).	9677.410	9677.410	9677.410	383
Connection space cover, rear	1 pc(s).	9677.412	9677.412	9677.412	386
Clamp-type terminal		–	–	–	
Box terminal		see page	see page	see page	387
Contact terminal	3 pc(s).	9677.485	9677.485	9677.485	387
Current converter		–	–	–	
Trim strip	2 pc(s).	9677.407	9677.407	9677.407	386
Micro-switch	1 pc(s).	9677.418	9677.418	9677.418	387

NH slimline switch-disconnectors



Busbar system Page 368 **Connection adaptors** Page 370 **Connection block** Page 371 **Component adaptors** Page 372

Functions:

- Automatic quick-break contact allows operator-independent switching
- Double-break for reliable disconnection of the contacts

Material:

- Polyamide
- Fire protection corresponding to UL 94-V0
- Contact tracks: Partially silver-plated hard copper

Colour:

- Chassis: RAL 7035
- Cover: RAL 7001
- Handle: RAL 7016

Basis of test:

- IEC/DIN EN 60 947-3
- DIN EN 60 269-2 (fuse inserts)

Size 00 – 3, with electronic fuse monitoring

Size	Packs of	00	00	1	2	3	Page
Design		3-pole, switchable	3-pole, switchable	3-pole, switchable	3-pole, switchable	3-pole, switchable	
Rated operating current max. A		160	160	250	400	630	
Rated operating voltage V, ~		400, 3~	400, 3~	400, 3~	400, 3~	400, 3~	
Number of poles		3-pole	3-pole	3-pole	3-pole	3-pole	
Installation type		Clamping attachment	Screw attachment	Screw attachment	Screw attachment	Screw attachment	
Cable outlet		Bottom	Bottom	Bottom	Bottom	Bottom	
Type of connection		Screw M8	Screw M8	Screw M12	Screw M12	Screw M12	
Connection of round conductors mm ²		1.5 - 95	1.5 - 95	6 - 240	6 - 240	6 - 240	
Width mm		50	50	100	100	100	
Height mm		860	860	941	941	941	
For converter installation		■	■	-	-	-	
For bar systems with centre-to-centre spacing mm		185	185	185	185	185	
For bar thickness mm		10	10	10	10	10	
Model No.	1 pc(s).	9677.080	9677.085	9677.180	9677.280	9677.380	
Accessories							
Connection space cover	1 pc(s).	9677.400	9677.400	9677.410	9677.410	9677.410	383
Connection space cover, rear	1 pc(s).	9677.402	9677.402	9677.412	9677.412	9677.412	386
Clamp-type terminal	3 pc(s).	9677.425	9677.425	-	-	-	386
Box terminal		-	-	see page	see page	see page	387
Contact terminal	3 pc(s).	-	-	9677.485	9677.485	9677.485	387
Current converter	1 pc(s).	9677.810	9677.810	-	-	-	385
Trim strip	2 pc(s).	9677.407	9677.407	9677.407	9677.407	9677.407	386
Micro-switch	1 pc(s).	9677.418	9677.418	9677.418	9677.418	9677.418	387

Busbar system 185 mm

Accessories



System attachment

for VX

For attaching busbar systems with 185 mm centre-to-centre spacing inside the enclosure.

Material:

- Sheet steel

Surface finish:

- Zinc-plated

Supply includes:

- 2 system attachments (left/right)
- 2 punched sections without mounting flanges
- Assembly parts

For enclosure width mm	Product-specific scope of supply	Packs of	Model No.
600	–	1 pc(s).	9677.511
800	–	1 pc(s).	9677.521
1000	System attachment (centre)	1 pc(s).	9677.531
1200	System attachment (centre)	1 pc(s).	9677.541



Assembly instruction:

- For variable depth adjustment of the busbar system in the enclosure, the punched section with mounting flange 23 x 64 mm for VX (for the inner mounting level) is additionally required. Select according to the enclosure depth.



Accessories:

- Punched section with mounting flange, 23 x 64 mm, see page 991
- Captive nuts, see page 1002



Busbar connector

For connecting rectangular busbars, no drilling required.

Material:

- E-Cu

Surface finish:

- Tin-plated

Note:

- If using a 100 x 10 mm busbar, one 9677.610 and one 9677.620 are required

For busbar mm	Quantity required per bar	Length mm	Packs of	Model No.
40 x 10	1	40	1 pc(s).	9677.610
80 x 10	2			
100 x 10	1			
60 x 10	1	60	1 pc(s).	9677.620
100 x 10	1			
120 x 10	2			



End cover

for busbar supports

For contact hazard protection of the busbar system on the left and right. Attachment is on the busbar supports.

Material:

- Polyamide
- Fire protection corresponding to UL 94-V0

Colour:

- RAL 7035

Supply includes:

- 1 end cover, left
- 1 end cover, right

To fit Model No.	Packs of	Model No.
9677.500	2 pc(s).	9677.600

Contact hazard protection cover plate

for 185 mm busbar system

For contact hazard protection of the busbar assembly at the rear and front.

Material:

- Base tray: Polyphenylene ether (PPE)
- End section: Polyphenylene ether (PPE)
- Cover section: Polyamide
- Centre cover: Polyamide

Colour:

- RAL 7035

Supply includes:

- Cover section, slotted, 50 mm wide
- Cover sections, slotted, 100 mm wide
- Base trays
- Trim sections

For enclosure width mm	Product-specific scope of supply	Packs of	Model No.
600	-	1 pc(s).	9677.550
800	-	1 pc(s).	9677.560
1000	Centre cover for busbar support	1 pc(s).	9677.570
1200	Centre cover for busbar support	1 pc(s).	9677.580



Accessories:

- Cover strip, see page 381

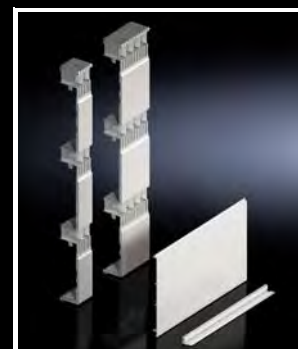

Cover strip

for contact hazard protection cover

For covering the front exposed contact slots in the cover section.

Material:

- Polyamide
- Fire protection corresponding to UL 94-V0

Colour:

- RAL 7035

Width mm	Height mm	To fit Model No.	Packs of	Model No.
100	67	9677.550/ 9677.560/ 9677.570/ 9677.580	3 pc(s).	9677.650

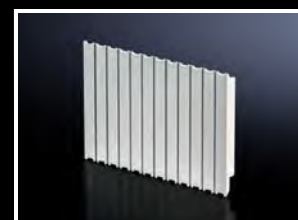

Contact hazard protection cover plate

for enclosure connection

For rear and front contact hazard protection of the connection points from enclosure to enclosure, with and without busbar connectors.

Material:

- Base tray: Polyphenylene ether (PPE)
- Cover section: Polyamide
- Centre cover: Polyamide

Colour:

- RAL 7035

Supply includes:

- 3 base trays
- 1 cover (front)
- 2 centre covers for busbar support

Packs of	Model No.
1 pc(s).	9677.640



Busbar system 185 mm

Accessories



Contact hazard protection cover plate

for connection block

To cover the connector block at the front.

Material:

- Polyamide
- Fire protection corresponding to UL 94-V0

Colour:

- RAL 7035

Width mm	Height mm	Packs of	Model No.
105	245	1 pc(s).	9677.925



Connector kit

for component adaptors

Preassembled connector kit for common brands of moulded-case circuit-breaker (MCCB). For electrical connection between the switch and the component adaptor (3-pole).

Material:

- E-Cu

Supply includes:

- Assembly parts

For switchgear make (model)	To fit Model No.	Packs of	Model No.
ABB (Tmax T7 - 800 A/1000 A) Schneider Electric (NS - 800 A/1000 A)	9677.700/9677.705	1 pc(s).	9677.730
Eaton (NZM4 - 800 A/1000 A) Siemens (VL1250/3VL7 - 1000 A)	9677.700/9677.705	1 pc(s).	9677.740
ABB (Tmax T7 - 1250 A/1600 A) Schneider Electric (NS - 1250 A/1600 A)	9677.710/9677.715	1 pc(s).	9677.750
Eaton (NZM4 - 1250 A/1600 A) Siemens (VL1250/3VL7 - 1250 A, VL1600/VL8 - 1600 A)	9677.710/9677.715	1 pc(s).	9677.760

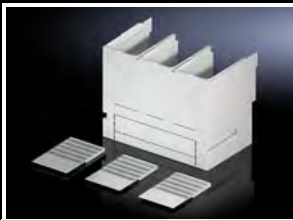

Contact hazard protection cover plate

for component adaptors

To cover the connector kit at the front. The cover may also optionally be used for the switchgear cable connection. Open cable accesses in the contact hazard protection cover may be sealed using the side panels.

Material:

- Polyamide
- Fire protection corresponding to UL 94-V0

Supply includes:

- Side panels

For switchgear make (model)	Packs of	Model No.
-	1 pc(s).	9677.790
ABB (Tmax T7)	1 pc(s).	9677.792
Eaton (NZM 4)	1 pc(s).	9677.794
Siemens (3VL7/3VL8)	1 pc(s).	9677.796
Schneider Electric (NS1600)	1 pc(s).	9677.798

Connection space cover

for NH slimline fuse-switch-disconnectors/NH slimline switch-disconnectors

Cascadable connection space cover to guarantee contact hazard protection in the cable connection zone when using ring terminals with a long collar.

Material:

- Polycarbonate
- Fire protection corresponding to UL 94-V0

Note:

- When using NH slimline fuse-switch disconnectors with top cable outlet, use of the connection space cover is mandatory

For size	To fit Model No.	Cable outlet	Note on Model No.	Packs of	Model No.
00	9677.0X0/9677.0X5	Bottom	Also suitable for use with NH slimline switch-disconnectors with top cable outlet	1 pc(s).	9677.400
00	9677.000/9677.010/ 9677.015/9677.025	Top	–	1 pc(s).	9677.405
1 - 3	9677.1X0/9677.1X5/ 9677.2X0/9677.2X5/ 9677.300/9677.310/ 9677.3X5	Top/bottom	–	1 pc(s).	9677.410

Contact terminal

for NH slimline fuse-switch disconnectors/ connection adaptors

For mounting components on busbar systems with 185 mm centre-to-centre spacing, no drilling required.

Material:

- Sheet steel, zinc-plated
- E-Cu, tin-plated

Note:

- Only suitable for use on busbar system with contact hazard protection cover (cover section, slotted)

For size	Packs of	Model No.
00	3 pc(s).	9677.450
1 - 3 and connection adaptors	3 pc(s).	9677.460



Busbar system 185 mm

Accessories



Busbar terminal

for NH slimline fuse-switch disconnectors/ connection adaptors

For mounting components on busbar systems with 185 mm centre-to-centre spacing, no drilling required.

Material:

- Sheet steel

Surface finish:

- Zinc-plated

Note:

- Can only be used on busbar systems without contact hazard protection cover (cover section, slotted)

For size	Packs of	Model No.
00	3 pc(s).	9677.470
1 - 3 and connection adaptors	3 pc(s).	9677.480



Prism terminal

for NH slimline fuse-switch disconnectors

For the direct connection of round conductors.

Material:

- Brass

Surface finish:

- Tin-plated

For size	To fit Model No.	Connection of round conductors mm ²	Packs of	Model No.
00	9677.000/ 9677.010/ 9677.015	10 - 95	3 pc(s).	9677.420



V connection terminal

for NH slimline fuse-switch disconnectors

For the direct connection of round conductors.

Material:

- Brass

Surface finish:

- Tin-plated

For size	To fit Model No.	Connection of round conductors mm ²	Packs of	Model No.
1/2	9677.100/ 9677.110/ 9677.115/ 9677.200/ 9677.210/ 9677.215	70 - 240	3 pc(s).	9677.430
3	9677.300/ 9677.310/ 9677.315	120 - 300	3 pc(s).	9677.440

Current converter

for NH slimline fuse-switch-disconnectors/ NH slimline switch-disconnectors

Compact design without altering the installation depth via mechanical integration into the NH slimline switch-disconnector (185 mm centre-to-centre spacing); this allows space-saving assembly.

Material:

– Polyamide

Basis of test:

– IEC 60 044-1
– EN 60715
– DIN VDE 0414
– DIN 42 600-2

For size	00	1 - 3	1 - 3	1 - 3	1 - 3
To fit Model No.	9677.000/ 9677.010/ 9677.015/ 9677.025/ 9677.060/ 9677.065/ 9677.070/ 9677.075/ 9677.080/ 9677.085	9677.100/ 9677.110/ 9677.115/ 9677.200/ 9677.210/ 9677.215/ 9677.300/ 9677.310/ 9677.315/ 9677.340	9677.100/ 9677.110/ 9677.115/ 9677.200/ 9677.210/ 9677.215/ 9677.300/ 9677.310/ 9677.315/ 9677.340	9677.100/ 9677.110/ 9677.115/ 9677.200/ 9677.210/ 9677.215/ 9677.300/ 9677.310/ 9677.315/ 9677.340	9677.100/ 9677.110/ 9677.115/ 9677.200/ 9677.210/ 9677.215/ 9677.300/ 9677.310/ 9677.315/ 9677.340
Primary current A	150	200	250	400	600
Secondary current A	5	5	5	5	5
Accuracy class	1	1	1	1	1
Rated frequency Hz	50 - 60	50 - 60	50 - 60	50 - 60	50 - 60
Insulation voltage kV	3	3	3	3	3
Insulating material category	E	B	B	B	B
Connection of round conductors mm ²	2.5 - 4	–	–	–	–
Type of connection	Screw terminals	Round conductor 2.5 mm ² (length 1.5 m)	Round conductor 2.5 mm ² (length 1.5 m)	Round conductor 2.5 mm ² (length 1.5 m)	Round conductor 2.5 mm ² (length 1.5 m)
Rated power input VA	2.5	1.5	2.5	2.5	2.5
Packs of	1 pc(s).	1 pc(s).	1 pc(s).	1 pc(s).	1 pc(s).
Model No.	9677.810	9677.840	9677.860	9677.870	9677.880

Cover

for NH slimline fuse-switch disconnectors

To increase rear contact hazard protection of the NH slimline fuse-switch-disconnector in the top section when mounting on a 185 mm bar system with contact hazard protection.

Material:

– Polyamide

Colour:

– RAL 7035

For size	Packs of	Model No.
1 - 3	5 pc(s).	9677.415

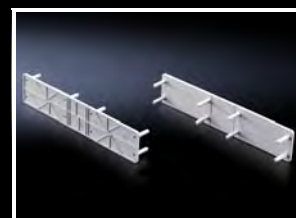

Busbar system 185 mm

Accessories



Trim strip

**for NH slimline fuse-switch-disconnectors/
NH slimline switch-disconnectors**

To create a contact surface for individual use of a front contact hazard protection cover plate. Mounted on the side of the NH strip enclosure.

Material:

– Hard PVC

Colour:

– RAL 7035

For size	Packs of	Model No.
00 - 3	2 pc(s).	9677.407



Connection space cover, rear

for NH slimline switch-disconnectors

To guarantee contact hazard protection in the rear cable connection zone when using ring terminals with long press sleeves. In conjunction with the front connection space cover (9677.400/.410), this achieves all-round contact hazard protection of the connection space.

Material:

– Polyamide

Colour:

– RAL 7035

For size	Packs of	Model No.
00	1 pc(s).	9677.402
1 - 3	1 pc(s).	9677.412



Clamp-type terminal

for NH slimline switch-disconnectors

For the connection of round conductors.

Material:

– Sheet steel

Surface finish:

– Zinc-plated

For size	Connection of round conductors mm ²	Packs of	Model No.
00	16 - 70	3 pc(s).	9677.425

Busbar system 185 mm

Accessories

Box terminal

for NH slimline switch-disconnectors

For converting NH slimline switch-disconnectors to box terminal connection for round conductors.

Material:

- Aluminium
- E-Cu, silver-plated

Supply includes:

- Connection space cover, rear

For size	Connection of round conductors mm ²	Packs of	Model No.
1 - 3	70 - 240	3 pc(s).	9677.435
1 - 3	185 - 300	3 pc(s).	9677.445



Contact terminal

for NH slimline switch-disconnectors

For mounting NH slimline switch-disconnectors on bar systems with 185 mm centre-to-centre spacing, no drilling required.

Material:

- Sheet steel, zinc-plated
- E-Cu, tin-plated
- Polyamide

Note:

- Only suitable for use on busbar system with contact hazard protection cover (cover section, slotted)

For size	Packs of	Model No.
1 - 3	3 pc(s).	9677.485



Micro-switch

for NH slimline switch-disconnectors

To indicate the switch position of the NH unit (cover).

Supply includes:

- Bracket

For size	Rated operating current max. A	Rated operating voltage V	Packs of	Model No.
00 - 3	5	250	1 pc(s).	9677.418



Busbar systems (100/185/150 mm)



NH slimline fuse-switch disconnectors Page 335/374

Material: Busbar supports, inserts

- Fibreglass-reinforced, thermoplastic polyester (PBT)
- Fire protection corresponding to UL 94-V0

Colour:

- RAL 7035

Note:



- The base component of busbar support 3052.000 may also be used as a single-pole support

Busbar systems

1250 A (100 mm), 1600 A (185 mm), 2500 A (150 mm), 3000 A (150 mm)

Busbar supports, 3-pole		Packs of	Model No.				Page	
			A 1250 A	B 1600 A	C 2500 A	C 3000 A		
	Width x height x depth mm		22 x 320 x 70	24 x 515 x 51	30 x 420 x 160	30 x 420 x 170		
	Max. bar accommodation mm		60 x 10	80 x 10	2 x 80 x 10	2 x 100 x 10		
	Inserts for							
	a) Reducing the cross-section to mm		30 x 10 to 50 x 10	50/60 x 10	-	-		
	b) Reducing the bar width in 10 mm increments		-	-	■	■		
	Bar centre distance mm		100	185	150	150		
	Packs of		4 pc(s).	2 pc(s).	2 pc(s).	2 pc(s).		
			3073.000	3052.000	3055.000	3057.000		
Accessories								
	Inserts to adapt the bar dimensions	30 x 10 mm	24 pc(s).	3074.000	-	-	-	
		40 x 10 mm	24 pc(s).	3075.000	-	-	-	
		50 x 10 mm	24 pc(s).	3076.000	3074.000	-	-	
		60 x 10 mm	24 pc(s).	-	3075.000	-	-	
Spacing piece for reducing the bar width in 10 mm increments			12 pc(s).	-	-	3056.000	3056.000	
Busbars E-Cu to DIN EN 13 601, length 2400 mm								
	Dimensions mm							
	30 x 10	3 pc(s).	3586.005	-	-	-	-	
	40 x 10	3 pc(s).	3587.000	-	-	-	-	
	50 x 10	2 pc(s).	3588.005	3588.005	-	-	-	
	60 x 10	2 pc(s).	3589.005	3589.005	3589.005	3589.005	3589.005	
	80 x 10	1 pc(s).	-	3590.005	3590.005	3590.005	3590.005	
100 x 10	1 pc(s).	-	-	-	-	3590.015		
							342	

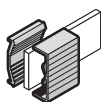
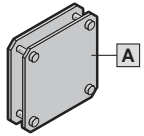
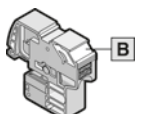
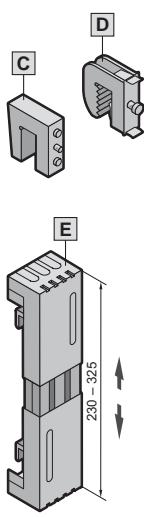
Busbar systems (100/185/150 mm)

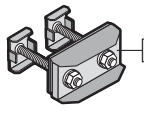
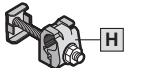
Contact hazard protection		Packs of	Model No.				Page	
			1250 A	1600 A	2500 A	3000 A		
End cover for busbar supports		10 pc(s).	3083.000	-	-	-	343	
	Busbar cover section, length 1 m for E-Cu	30 x 10 mm	10 pc(s).	3092.000	-	-		
		40 x 10 to 60 x 10 mm	10 pc(s).	3085.000	3085.000	-		-
Connection system, see page 349 (system accessories)								
	A Plate clamps for connecting laminated copper bars; no drilling required							
	For busbars mm	Clamping area for laminated copper bars mm					350	
	30 x 10	34 x 10	3 pc(s).	3554.000	-	-		
	40 x 10	34 x 10	3 pc(s).	3559.000	-	-		
	50 x 10	34 x 10	3 pc(s).	3560.000	3560.000	-		
	50 x 10	54 x 10	3 pc(s).	3562.000	3562.000	-		
	60 x 10	34 x 10	3 pc(s).	3561.000	3561.000	-		
	60 x 10	54 x 10	3 pc(s).	3563.000	3563.000	-		
	80 x 10	65 x 10	3 pc(s).	-	3460.500	-		
		B Push-in conductor connection clamps for 10 mm bar thickness						
Connection of round conductors mm ²		Clamping area for laminated copper bars mm						349
0.5 – 6		-	10 pc(s).	3455.505	3455.505	3455.505		
1.5 – 16	-	10 pc(s).	3456.505	3456.505	3456.505			
	Conductor connection clamps for 10 mm bar thickness							
	Connection of round conductors mm ²	Clamping area for laminated copper bars mm					349	
	C 1 – 4	-	15 pc(s).	3555.000	3555.000	3555.000		
	1 – 4	-	15 pc(s).	3455.500	3455.500	3455.500		
	2.5 – 16	8 x 8	15 pc(s).	3456.500	3456.500	-		
	D 16 – 50	10.5 x 11	15 pc(s).	3457.500	3457.500	-		
	35 – 70	16.5 x 15	15 pc(s).	3458.500	3458.500	-		
	70 – 185	22.5 x 20	15 pc(s).	3459.500	3459.500	-		
	E System covers for conductor connection clamps and plate clamps							
	Width x depth mm							350
50 x 80	4 pc(s).	3086.000	-	-	-			
100 x 80	4 pc(s).	3087.000	-	-	-			
100 x 110	4 pc(s).	3090.000	-	-	-			
200 x 80	4 pc(s).	3088.000	-	-	-			
200 x 110	4 pc(s).	3091.000	-	-	-			
	F Inserted screw nuts M12 , self-holding nuts with knurled ring for mounting NH slimline fuse-switch disconnectors							
	For drilled holes in busbars Ø 14.5 mm		30 pc(s).	3591.060	3591.060	-	1039	
	G Connection plate for laminated copper bars							
	For connecting laminated copper bars up to 2 x 10 x 100 x 1.0 mm to a busbar system with 2 bars per conductor	For laminated copper bars up to					399	
		2 x 10 x 32 x 1 mm	1 pc(s).	-	-	9676.747 ¹⁾		
		2 x 10 x 63 x 1 mm	1 pc(s).	-	-	9676.748 ¹⁾		
	2 x 10 x 100 x 1 mm	1 pc(s).	-	-	9676.749 ¹⁾			
	H Direct connection terminal							
	For the direct connection of round conductors 95 – 300 mm ² (single-wire and multi-wire)		1 pc(s).	-	-	9676.730 ¹⁾	9676.730 ¹⁾	

¹⁾ The required screw connection must be ordered separately according to the busbar width, see page 400

VX25 Ri4Power – Greater flexibility with interior installation



Variable adaptation

- Removal of the pre-punched knock-outs in the compartment dividers is burr-free, for flexible subdivision of the openings depending on the planned cable routing. This supports a continuous, direct power supply to the control and wiring sections.
- Cross member cutter 4054.870 for removing the pre-punched knock-outs, see page 586.

Flexible busbar routing

- The main busbars may optionally be routed in the roof section or central rear section, for enhanced planning and space flexibility.

Optimum continuity

- Because PE or N conductors are connected by directly screw-fastening the busbar supports to the frame section, this ensures an identical, consistent arrangement of bars in the rear or front enclosure area across all section types.



Power distribution



VX25 Ri4Power – Enhanced efficiency for bar systems



Significant reduction in parts

- The 25 mm pitch pattern allows busbar supports to be mounted directly onto the enclosure section. Just three screws is all you need. No further components are required.

A high level of standardisation

- Standard bars in sizes 30 x 10 mm and 50 x 10 mm are used.

Quick busbar connection

- The open busbar support can additionally accommodate the busbar connector, for simple, fast connection to the next section.



Power distribution



Busbar system

Flat-PLS



Busbar supports

for distribution busbar system

For assembling vertical distribution busbar systems (2 x 30 x 10 mm, 3-/4-pole, 70 mm centre-to-centre spacing) or busbar systems (30 x 5/10 mm, 3-/4-pole, 60 mm centre-to-centre spacing) with RiLine components in modular outgoing sections.

Material:

- Duroplastic
- Fire protection corresponding to UL 94-V0

Colour:

- Similar to RAL 9005

Supply includes:

- Assembly parts

For busbar mm	Bar centre distance mm	Packs of	Model No.
30 x 5/10 30 x 10	60 70	2 pc(s).	9686.100



Also required:

- Busbars E-Cu, see page 342



Accessories:

- End cover, see page 396



Busbar supports

for busbar entry (roof section)

For inserting 3- or 4-pole flat copper busbar systems into the roof section.

Material:

- Duroplastic
- Fire protection corresponding to UL 94-V0

Colour:

- Similar to RAL 9005

Supply includes:

- Assembly parts



For busbar mm	Bar centre distance mm	Packs of	Model No.
30 x 10	80	2 pc(s).	9686.010
50 x 10	80	2 pc(s).	9686.040



Also required:

- Busbars E-Cu, see page 342
- Captive nuts, see page 1002



Assembly instruction:

- For the installation of max. 4 busbars (sub-conductors) per phase
- Cage nut (M8) 4165.500 is required to attach the busbar supports to the enclosure section.



Accessories:

- End cover, see page 396

Busbar system

Flat-PLS

Busbar supports

for busbar baying (roof section)

For baying 3- or 4-pole flat copper busbar systems from enclosure to enclosure in the roof section.

Material:

- Duroplastic
- Fire protection corresponding to UL 94-V0

Colour:

- Similar to RAL 9005

Supply includes:

- Assembly parts

For busbar mm	Bar centre distance mm	Packs of	Model No.
30 x 10	80	2 pc(s).	9686.000
50 x 10	80	2 pc(s).	9686.030



Also required:

- Busbars E-Cu, see page 342
- Longitudinal connector E-Cu, see page 397
- Captive nuts, see page 1002



Assembly instruction:

- For the installation of max. 4 busbars (sub-conductors) per phase
- Cage nut (M8) 4165.500 is required to attach the busbar supports to the enclosure section.



Accessories:

- End cover, see page 396



Possible alternative:

- Busbar E-Cu, slotted, see page 396



Busbar supports

for busbar entry (rear section)

For inserting 3-pole flat copper busbar systems into the rear section of the enclosure.

Material:

- Duroplastic
- Fire protection corresponding to UL 94-V0

Colour:

- Similar to RAL 9005

Supply includes:

- Assembly parts

For busbar mm	Bar centre distance mm	Packs of	Model No.
50 x 10	185	2 pc(s).	9686.070



Also required:

- Busbars E-Cu, see page 342
- Captive nuts, see page 1002



Assembly instruction:

- For the installation of max. 4 busbars (sub-conductors) per phase
- Cage nut (M8) 4165.500 is required to attach the busbar supports to the enclosure section.



Accessories:

- End cover, see page 396



Busbar system

Flat-PLS



Busbar supports

for busbar baying (rear section)

For baying 3-pole flat copper busbar systems in the rear section from enclosure to enclosure.

Material:

- Duroplastic
- Fire protection corresponding to UL 94-V0

Colour:

- Similar to RAL 9005

Supply includes:

- Assembly parts

For busbar mm	Bar centre distance mm	Packs of	Model No.
50 x 10	185	2 pc(s).	9686.060



Also required:

- Busbars E-Cu, see page 342
- Longitudinal connector E-Cu, see page 397
- Captive nuts, see page 1002



Assembly instruction:

- For the installation of max. 4 busbars (sub-conductors) per phase
- Cage nut (M8) 4165.500 is required to attach the busbar supports to the enclosure section.



Accessories:

- End cover, see page 396



Possible alternative:

- Busbar E-Cu, slotted, see page 396



End cover

for busbar supports

For shock-hazard-protected covering of the busbar ends on the busbar holder.

Material:

- Polyamide
- Fire protection corresponding to UL 94-HB

Colour:

- Similar to RAL 9005

Supply includes:

- Assembly parts

Width mm	Height mm	Packs of	Model No.
50	147	3 pc(s).	9686.080



Busbar E-Cu, slotted

Busbars with integral punchings.

Material:

- E-Cu F30

Standards:

- DIN EN 13 601

Dimensions mm	Length mm	Hole diameter mm	Packs of	Model No.
50 x 10	385	11.5	1 pc(s).	9684.004
50 x 10	585	11.5	1 pc(s).	9684.006
50 x 10	785	11.5	1 pc(s).	9684.008
50 x 10	985	11.5	1 pc(s).	9684.010
50 x 10	1185	11.5	1 pc(s).	9684.012



Accessories:

- Longitudinal connector E-Cu, see page 397

Longitudinal connector E-Cu

for busbar baying

For connecting the main busbar system from enclosure to enclosure.

Material:

- E-Cu

Supply includes:

- Assembly parts



Design for main busbar 30 x 10 mm

Dimensions mm	Length mm	No. of sub-conductors per phase	Packs of	Model No.
35 x 10	195	1	1 pc(s).	9686.210
60 x 10	195	2 4	1 pc(s).	9686.200

Design for main busbar 50 x 10 mm

Dimensions mm	Length mm	No. of sub-conductors per phase	Packs of	Model No.
55 x 10	195	1	1 pc(s).	9686.260
100 x 10	195	2 4	1 pc(s).	9686.250

Busbar system

Connection system Flat-PLS



Busbar claw

for flat copper busbars

For mechanical stabilisation of busbar stacks. Suitable for 10 mm bar thickness.

Material:

- Stainless steel

For no. of busbars	Mounting dimensions mm	Packs of	Model No.
2	20	1 pc(s).	9676.017
4	20	1 pc(s).	9676.019



Also required:

- M10 screw, see page 400



Assembly instruction:

- The required screw length must be selected in line with the busbar width W, i.e. length = W + fastening measurement. Screws are not included with the supply.
- Busbar claw with threaded insert M10



Busbar claw

for connection components

For mechanical connection of connection components such as connection brackets. Suitable for 10 mm bar thickness.

Material:

- Stainless steel

For no. of busbars	Mounting dimensions mm	Packs of	Model No.
2	40	8 pc(s).	9676.832



Also required:

- M10 screw, see page 400



Assembly instruction:

- The required screw length must be selected in line with the busbar width W, i.e. length = W + fastening measurement. Screws are not included with the supply.
- Busbar claw with threaded insert M10



Direct connection terminal

for round conductors

For connecting round conductors to a busbar distributor system made from flat copper. Suitable for 10 mm bar thickness.

Material:

- Connection clamp: Brass, tin-plated
- Busbar claw: Stainless steel

Supply includes:

- Assembly parts (excluding screws)

No. of sub-conductors per phase	Connection of round conductors mm ²	Mounting dimensions mm	Packs of	Model No.
2	95 - 300	60	1 pc(s).	9676.730



Also required:

- M10 screw, see page 400



Assembly instruction:

- The required screw length must be selected in line with the busbar width W, i.e. length = W + fastening measurement. Screws are not included with the supply.
- Busbar claw with threaded insert M10



Busbar system

Connection system Flat-PLS

Connection plate

for laminated copper bars

For connecting laminated copper bars to a busbar distributor system made from flat copper. Suitable for 10 mm bar thickness.

Material:

- Connection plate: E-Cu
- Thrust piece: Stainless steel
- Busbar claw: Stainless steel

Supply includes:

- Assembly parts (excluding screws)

No. of sub-conductors per phase	Clamping area for laminated copper bars (W x H) mm	Mounting dimensions mm	Packs of	Model No.
2	32 x 20	50	1 pc(s).	9676.747
2	63 x 20	50	1 pc(s).	9676.748
2	100 x 20	50	1 pc(s).	9676.749



Also required:

- M10 screw, see page 400



Assembly instruction:

- The required screw length must be selected in line with the busbar width W, i.e. length = W + fastening measurement. Screws are not included with the supply.
- Busbar claw with threaded insert M10



Accessories:

- Laminated copper bar, see page 346



Connection plate

for ring terminals

For connecting ring terminals to a busbar distributor system made from flat copper. Suitable for 10 mm bar thickness.

Material:

- Connection plate: E-Cu, nickel-plated
- Busbar claw: Stainless steel

Supply includes:

- Assembly parts (excluding screws)

Thread	No. of sub-conductors per phase	Mounting dimensions mm	Product-specific scope of supply	Packs of	Model No.
M10	2	40	-	1 pc(s).	9676.710
M12	2	20	Grub screw	1 pc(s).	9676.700



Also required:

- M10 screw, see page 400



Assembly instruction:

- The required screw length must be selected in line with the busbar width W, i.e. length = W + fastening measurement. Screws are not included with the supply.
- Busbar claw with threaded insert M10



Busbar system

Connection system Flat-PLS



Connection set

for Flat-PLS

For attaching NH slimline fuse-switch disconnectors and NH slimline switch-disconnectors (185 mm) or for connecting busbars. Suitable for busbar system with flat copper 50 x 10 mm

Material:

- Sheet steel, zinc-plated

Note:

- Screws are not included with the supply

Thread	For no. of busbars	Packs of	Model No.
M8	2	3 pc(s).	9686.800
	4		
M10	2	3 pc(s).	9686.810
	4		

Assembly instruction:

- The connection set may only be used with top-mounting components with screw fastening
- NH slimline fuse-switch disconnectors:
The required screw length when using busbars is 2 x 50 x 10 mm = 35 mm and 4 x 50 x 10 mm = 55 mm
- NH slimline switch-disconnectors: Only suitable for attaching to busbars 2 x 50 x 10 mm
- When using 4 busbars per phase, a filler piece is additionally required

Accessories:

- M10 screw, see page 400
- Filler piece, see page 400



Filler piece

for connection set

When using top-mounting components on a busbar system with 4 busbars per phase, a filler piece is additionally required between the bars.

Material:

- E-Cu

Dimensions mm	Length mm	Packs of	Model No.
25 x 10	110	3 pc(s).	9686.820



M10 screw

For attaching the busbar claw or connection components to a flat copper busbar system.

Material:

- Stainless steel

Screw design mm	Packs of	Model No.
M10 x 60	8 pc(s).	9676.806
M10 x 70	8 pc(s).	9676.807
M10 x 80	8 pc(s).	9676.808
M10 x 90	8 pc(s).	9676.809
M10 x 100	8 pc(s).	9676.810
M10 x 110	8 pc(s).	9676.811
M10 x 120	8 pc(s).	9676.812
M10 x 130	8 pc(s).	9676.813
M10 x 140	8 pc(s).	9676.814
M10 x 150	8 pc(s).	9676.815
M10 x 160	8 pc(s).	9676.816
M10 x 170	8 pc(s).	9676.817
M10 x 190	8 pc(s).	9676.819

Busbar system

Maxi-PLS

End supports

for Maxi-PLS busbars

For attaching Maxi-PLS busbars when used as a cable connection system. The stepped configuration ensures simple cable installation.

Material:

- Polyamide
- Fire protection corresponding to UL 94-V0

Colour:

- Similar to RAL 9011

Supply includes:

- Assembly parts

For system	Packs of	Model No.
Maxi-PLS 45 S Maxi-PLS 45	2 pc(s).	9649.010
Maxi-PLS 60	2 pc(s).	9659.010



Also required:

- Maxi-PLS busbar, E-Cu for Maxi-PLS 45 S system, see page 401
- Maxi-PLS busbar, E-Cu for Maxi-PLS 45 system, see page 401
- Maxi-PLS busbar, E-Cu for Maxi-PLS 60 system, see page 402



Maxi-PLS busbar, E-Cu

for Maxi-PLS 45 S system

For assembling cable connection systems.

Material:

- E-Cu

Note:

- May be cut individually to required length

Cross-section 974 mm²

For enclosure width mm	Length mm	Packs of	Model No.
600	451	1 pc(s).	9640.207
800	651	1 pc(s).	9640.237
1000	851	1 pc(s).	9640.267
1200	1051	1 pc(s).	9640.297
-	2400	3 pc(s).	9640.365

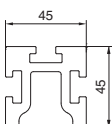

Maxi-PLS 45 S



Maxi-PLS busbar, E-Cu

for Maxi-PLS 45 system

For assembling cable connection systems.

Material:

- E-Cu

Note:

- May be cut individually to required length

Cross-section 1354 mm²

For enclosure width mm	Length mm	Packs of	Model No.
600	451	1 pc(s).	9640.202
800	651	1 pc(s).	9640.232
1000	851	1 pc(s).	9640.262
1200	1051	1 pc(s).	9640.292
-	2400	3 pc(s).	9640.360
-	2400	4 pc(s).	9649.360

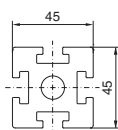

Maxi-PLS 45



Busbar system

Maxi-PLS



Maxi-PLS busbar, E-Cu

for Maxi-PLS 60 system

For assembling cable connection systems.

Material:

– E-Cu

Note:

– May be cut individually to required length

Cross-section 2323 mm²

For enclosure width mm	Length mm	Packs of	Model No.
600	451	1 pc(s).	9650.202
800	651	1 pc(s).	9650.232
1000	851	1 pc(s).	9650.262
1200	1051	1 pc(s).	9650.292
–	2400	3 pc(s).	9650.360
–	2400	4 pc(s).	9659.360

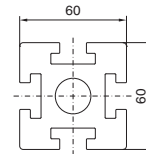

Maxi-PLS 60



Busbar system

Connection system Maxi-PLS

Connection clamp

for round conductors

For the connection of round conductors.

Material:

- Connection clamp: Brass, tin-plated
- Terminal stud: Steel, zinc-plated
- Sliding block: E-Cu

Supply includes:

- Connection clamp
- Terminal studs
- Sliding block
- Assembly parts

For system	Connection of round conductors mm ²	Packs of	Model No.
Maxi-PLS 45 S/45	95 - 300	1 pc(s).	9640.325
Maxi-PLS 60	95 - 300	1 pc(s).	9650.325



Connection plate

for laminated copper bars

For the connection of laminated flat copper bars.

Material:

- Connection plate: E-Cu
- Thrust piece: Stainless steel

Supply includes:

- Assembly parts

For system	Clamping area for laminated copper bars (W x H) mm	Packs of	Model No.
Maxi-PLS 45 S/45	32 x 20	3 pc(s).	9640.330
Maxi-PLS 45 S/45	63 x 20	3 pc(s).	9640.340
Maxi-PLS 45 S/45	100 x 20	3 pc(s).	9640.350
Maxi-PLS 60	32 x 20	3 pc(s).	9650.330
Maxi-PLS 60	63 x 20	3 pc(s).	9650.340



Accessories:

- Laminated copper bar, see page 346

Terminal studs

for Maxi-PLS

For connecting cables with ring terminals.

Material:

- Terminal stud: Steel, zinc-plated
- Sliding block: E-Cu

Supply includes:

- Terminal studs
- Sliding blocks
- Assembly parts

For system	Thread	Thread length mm	Packs of	Model No.
Maxi-PLS 45 S/45	M12	30	3 pc(s).	9640.370
Maxi-PLS 45 S/45	M16	30	3 pc(s).	9640.380
Maxi-PLS 60	M12	32	3 pc(s).	9650.370
Maxi-PLS 60	M16	32	3 pc(s).	9650.380

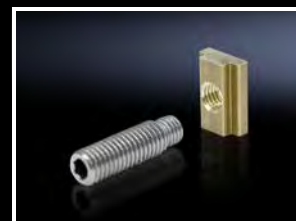

Sliding block

for Maxi-PLS busbars

For attaching flat copper bars and connection components to Maxi-PLS busbars. For sliding into the busbar section at the side and tightening the threaded bolts.

Material:

- E-Cu

For system	Length mm	Thread	Packs of	Model No.
Maxi-PLS 45 S/45	20	M8	15 pc(s).	9640.970
Maxi-PLS 45 S/45	25	M10	15 pc(s).	9640.980
Maxi-PLS 60	25	M10	15 pc(s).	9650.980
Maxi-PLS 60	35	M12	15 pc(s).	9650.990

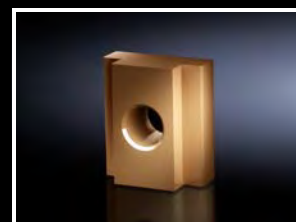

Also required:

- Threaded bolts, see page 404

Busbar system

Connection system Maxi-PLS



Sliding nut

for Maxi-PLS busbars

For attaching flat copper bars and connection components to Maxi-PLS busbars. For sliding into the busbar section retrospectively and tightening the threaded bolts.

Material:

- E-Cu

For system	Thread	Packs of	Model No.
Maxi-PLS 45 S/45	M6	15 pc(s).	9640.900
Maxi-PLS 45 S/45	M8	15 pc(s).	9640.910
Maxi-PLS 45 S/45	M10	15 pc(s).	9640.920
Maxi-PLS 60	M6	15 pc(s).	9650.900
Maxi-PLS 60	M8	3 pc(s).	9650.905
Maxi-PLS 60	M10	15 pc(s).	9650.910
Maxi-PLS 60	M12	15 pc(s).	9650.920



Also required:

- Threaded bolts, see page 404



Threaded bolts

for sliding blocks and sliding nuts

For individual connection options.

Material:

- Steel

Supply includes:

- Assembly parts



Also required:

- Sliding block, see page 403
- Sliding nut, see page 404

For system	Thread	Thread length mm	Packs of	Model No.
Maxi-PLS 45 S/45 Maxi-PLS 60	M6	35	6 pc(s).	9640.930
Maxi-PLS 45 S/45 Maxi-PLS 60	M8	35	6 pc(s).	9640.940
Maxi-PLS 45 S/45 Maxi-PLS 60	M10	35	8 pc(s).	9676.971
Maxi-PLS 45 S/45 Maxi-PLS 60	M10	45	8 pc(s).	9676.972
Maxi-PLS 45 S/45 Maxi-PLS 60	M10	55	8 pc(s).	9676.973
Maxi-PLS 45 S/45 Maxi-PLS 60	M10	70	8 pc(s).	9676.976
Maxi-PLS 45 S/45 Maxi-PLS 60	M10	80	8 pc(s).	9676.977
Maxi-PLS 60	M12	40	8 pc(s).	9676.981
Maxi-PLS 60	M12	50	8 pc(s).	9676.982
Maxi-PLS 60	M12	60	8 pc(s).	9676.983
Maxi-PLS 60	M12	70	8 pc(s).	9676.986
Maxi-PLS 60	M12	80	8 pc(s).	9676.987



Compact infeed

for Maxi-PLS

For individual use as a 3-pole cable connection bar system. Direct mounting on the mounting plate or punched section without mounting flange.

Material:

- End support: Polyamide (PA 6)
- Retaining plate: Sheet steel, zinc-plated
- Punched rail: Sheet steel, zinc-plated

Supply includes:

- 6 end supports
- 2 support plates for end supports
- 1 punched rail 23 x 23 mm (length 495 mm)
- Assembly parts

For system	Packs of	Model No.
Maxi-PLS 45 S/45	1 pc(s).	9660.980

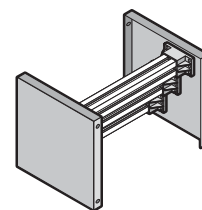

Busbar system

Accessories for connection components

Screw

for connection components

For connecting components such as connection brackets and connection kits.

Material:

- Sheet steel, zinc-plated

Supply includes:

- 8 nuts and 16 washers

Screw design mm	Packs of	Model No.
M10 x 40	8 pc(s).	9676.966
M10 x 45	8 pc(s).	9686.845
M10 x 55	8 pc(s).	9686.865
M10 x 60	8 pc(s).	9676.967
M10 x 80	8 pc(s).	9676.968



Support set (stabiliser)

for connector kit

To support connector kits, top or bottom, for open air circuit-breakers (ACB).

Material:

- Stabiliser: Fibreglass-reinforced polyester
- Angle bracket: Sheet steel

Supply includes:

- 4 plastic stabilisers
- 2 angle brackets
- Assembly parts

Note:

- The angle brackets included with the supply are only suitable for use in TS enclosures
- When using the support set in VX enclosures, angle bracket 9686.495 is additionally required

Packs of	Model No.
1 pc(s).	9660.205

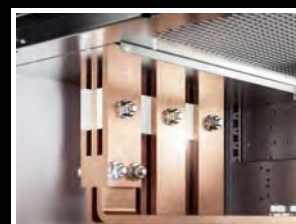

Angle bracket

for support set (stabiliser)

For positioning and securing the holder set (stabiliser) to the enclosure section.

Material:

- Sheet steel, zinc-plated

Supply includes:

- Assembly parts

Note:

- An angle bracket consists of one bracket to be fastened to the enclosure section or the compartment side panel, and one bracket for mounting plastic stabilisers

Packs of	Model No.
4 pc(s).	9686.495



Busbar system

Connection components

Connection components for air circuit-breakers and busbar connections

For connecting air circuit-breakers (ACB) or for connecting horizontal and vertical busbar systems (T-connectors).

Material:

- E-Cu

Note:

- The design code required for the configuration code is generated by the VX25 Rittal Power Engineering software (www.rittal.com/rpevx25/)
- Please quote the complete configuration code on all enquiries and orders (see example)

Configuration code = order number + design code	Description	Section types
Model No. 9686.912 + design code	Connector kit for top/bottom	Air circuit-breakers (ACB), coupling section, cable transition section
Model No. 9686.924 + design code	T-connector kit for top/bottom	Modular outgoing feeder section, fuse-switch disconnect section horizontal/vertical, multi-terminal busbar section, riser section, corner section

Example of creating the configuration code

1. Select section type "air circuit-breaker"



Busbar system

Connection components

2. Select switch and manufacturer and enter other technical parameters, such as busbar position, number of poles, rated current etc.



3. The connector kit data is output using the "Determine prices and weights" function. Design code and associated drawings (.dwg, .pdf) are available via the "Download" function. The configuration code for the enquiry or order will then look like this:
Air circuit-breaker (ACB) Model No. 9686.912 + 8068A1A4H3V661O4-70



Cover systems

Form 1

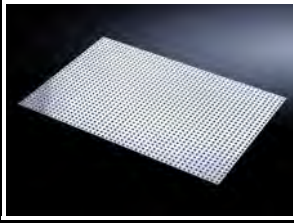

Cover plate

Slotted

To cover live parts and comply with the internal protection category IP 2X and IP XXB within low-voltage switchgear and controlgear. Integral vent holes allow convection inside a system.

Material:

- PVC

Width mm	Height mm	Packs of	Model No.
1200	800	1 pc(s).	9674.990



Accessories:

- Mounting bracket, see page 408



Mounting bracket

for contact hazard protection cover

For the attachment of contact hazard protection covers. Tapped hole M6.

Material:

- Sheet steel

Surface finish:

- Zinc-plated

Supply includes:

- Assembly screws

Packs of	Model No.
24 pc(s).	9660.090

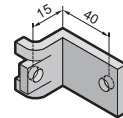

Contact hazard protection cover plate

for enclosures with NH slimline fuse-switch disconnectors

To cover outgoing sections with NH slimline fuse-switch disconnectors and busbar system in the rear enclosure section so that they are safe from finger contact (IP 2X).

Material:

- Sheet steel, 1.5 mm

Surface finish:

- Zinc-plated

Supply includes:

- 4 side panels (left/right side)
- 2 side panels (top/bottom)
- Assembly parts

Note:

- The specified installation width when using the contact hazard protection cover only applies when using busbar supports 9686.060/9686.070

For enclosure width mm	Free installation width when using Flat-PLS mm	Packs of	Model No.
600	400	1 pc(s).	9684.960
800	600	1 pc(s).	9684.980
1000	800	1 pc(s).	9684.900
1200	1000	1 pc(s).	9684.920



Accessories:

- Blanking cover, see page 409



Blanking cover

for contact hazard protection cover

To cover free NH slimline fuse-switch disconnector slots.

Material:

- Sheet steel, 1.5 mm

Surface finish:

- Zinc-plated

Supply includes:

- 2 covers
- 2 cover brackets
- Assembly parts

Width mm	Packs of	Model No.
50	2 pc(s).	9684.990



Compartment configuration

Form 1-4

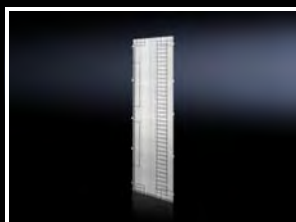

Compartment side panel

for VX

Side divider panel for attaching partial mounting plates and compartment dividers.

Material:

- Sheet steel, 1.5 mm

Surface finish:

- Zinc-plated

Supply includes:

- Assembly parts



For busbar system assembly in the rear section

For enclosure height mm	For enclosure depth mm	Height mm	Depth mm	Packs of	Model No.
2000	600	1881	538	2 pc(s).	9683.006
2000	800	1881	738	2 pc(s).	9683.008

For busbar system assembly in the roof section

For enclosure height mm	For enclosure depth mm	Height mm	Depth mm	Packs of	Model No.
2000	600	1731	538	2 pc(s).	9683.016
2000	800	1731	738	2 pc(s).	9683.018
2200	600	1931	538	2 pc(s).	9683.036
2200	800	1931	738	2 pc(s).	9683.038



Accessories:

- Plastic gland plate, see page 410
- Compartment divider, see page 411
- Partial mounting plate, see page 413



Plastic gland plate

for compartment side panel

For closing cable entry openings.

Material:

- PVC, 3 mm

Colour:

- Similar to RAL 7045

Supply includes:

- Assembly parts

Width mm	Height mm	Packs of	Model No.
152	48	10 pc(s).	9683.040



Retaining plate

for cable connection space

For mounting Maxi-PLS busbars including end supports in the cable connection area.

Material:

- Sheet steel, 1.5 mm

Surface finish:

- Zinc-plated

Supply includes:

- Assembly parts

For enclosure depth mm	Height mm	Depth mm	Packs of	Model No.
600	375	543	2 pc(s).	9683.200
800	375	743	2 pc(s).	9683.210



Also required:

- End supports, see page 401

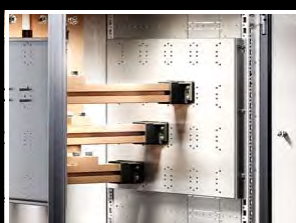

Compartment configuration

Form 1-4

Terminal box

for modular outgoing section

For shielding the connections (terminals) of the compartment, busbar space and cable chamber in accordance with Form 4b to IEC 61 439-2.

Material:

- Lid and cover: Sheet steel, 1.5 mm
- Cable retainer: Sheet steel

Surface finish:

- Lid and cover: Zinc-plated

Supply includes:

- 2 lids (top/bottom)
- 2 covers (front/rear)
- 2 cable retainers
- Assembly parts

For enclosure depth mm	For compartment height mm	Packs of	Model No.
600 800	150	1 pc(s).	9683.701
600 800	200	1 pc(s).	9683.702
600 800	300	1 pc(s).	9683.703
600 800	400	1 pc(s).	9683.704
600 800	600	1 pc(s).	9683.706



Also required:

- Compartment side panel, see page 410



Assembly instruction:

- The terminal boxes are externally mounted on the compartment side panel in the cable chamber, to match the heights of the compartments
- If necessary, a clamping strip may be mounted on the cable retainer included with the supply



Compartment divider

for VX

For the horizontal separation of compartments. In combination with the side panels, this creates Form separation to Form 1 to 4. For attachment to the compartment side panel or the enclosure section. The integral cut-outs with pre-punched knock-out option are used for the vertical routing of control lines or cable ducts and for the routing of distribution busbars or connection kits.

Design:

- With louvres

Material:

- Sheet steel, 1.5 mm

Surface finish:

- Zinc-plated

Supply includes:

- Assembly parts



Assembly instruction:

- For assembling compartments as internal Form separation, compartment side panels are required



Accessories:

- Plastic gland plate, see page 412
- Compartment side panel, see page 410



For enclosure width mm	For enclosure depth mm	Width mm	Depth mm	Packs of	Model No.
400	400	311	380	2 pc(s).	9683.444
400	600	311	580	2 pc(s).	9683.446
400	800	311	780	2 pc(s).	9683.448
600	400	511	380	2 pc(s).	9683.464
600	600	511	580	2 pc(s).	9683.466
600	800	511	780	2 pc(s).	9683.468
800	400	711	380	2 pc(s).	9683.484
800	600	711	580	2 pc(s).	9683.486
800	800	711	780	2 pc(s).	9683.488
1000	600	911	580	2 pc(s).	9683.406
1000	800	911	780	2 pc(s).	9683.408
1200	600	1111	580	2 pc(s).	9683.426
1200	800	1111	780	2 pc(s).	9683.428

Compartment configuration

Form 1-4

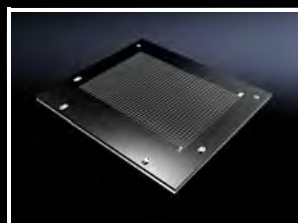

Plastic gland plate

for compartment divider

To cover the compartment divider with gland.

Material:

- ABS

Colour:

- Similar to RAL 9005

Supply includes:

- Assembly parts

Width mm	Height mm	Packs of	Model No.
250	251	2 pc(s).	9683.504
450	251	2 pc(s).	9683.506
650	251	2 pc(s).	9683.508
850	251	2 pc(s).	9683.500



Air circuit-breaker support bar

For the configuration of air circuit-breakers (ACB) in compartments.

Material:

- Sheet steel, 2.5 mm

Surface finish:

- Zinc-plated

Supply includes:

- Assembly parts

For enclosure width mm	Length mm	Packs of	Model No.
400	296	2 pc(s).	9683.304
600	496	2 pc(s).	9683.306
800	696	2 pc(s).	9683.308
1000	896	2 pc(s).	9683.310
1200	1096	2 pc(s).	9683.312

**Also required:**

- Mounting bracket, see page 412

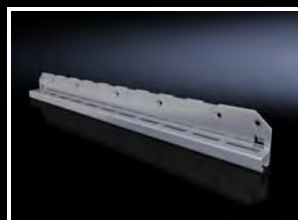

Mounting bracket

for air circuit-breaker support rail

For attaching the air circuit-breaker support rail to the enclosure section or compartment side panel.

Material:

- Sheet steel, 2.5 mm

Surface finish:

- Zinc-plated

Supply includes:

- Assembly parts

For enclosure depth mm	Packs of	Model No.
600	2 pc(s).	9683.326
800	2 pc(s).	9683.328

Compartment configuration

Form 1-4

Partial mounting plate

for compartment side panel

For direct attachment to the compartment side panel for internal compartmentalisation. Universal interior installation with switchgear and controlgear. Creation of additional mounting levels. In combination with compartment dividers and side panel, internal compartmentalisation in accordance with Form 1 to 4 is possible.

Material:

– Sheet steel, 2 mm

Surface finish:

– Zinc-plated

Supply includes:

– Angle brackets and assembly parts

Design Solid

For enclosure width mm	For compartment height mm	Width mm	Height mm	Packs of	Model No.
400	200	302	193	1 pc(s).	9683.642
400	300	302	293	1 pc(s).	9683.643
400	400	302	393	1 pc(s).	9683.644
400	600	302	593	1 pc(s).	9683.646
400	800	302	793	1 pc(s).	9683.648
600	1000	502	993	1 pc(s).	9683.660
600	150	502	143	1 pc(s).	9683.661
600	200	502	193	1 pc(s).	9683.662
600	300	502	293	1 pc(s).	9683.663
600	400	502	393	1 pc(s).	9683.664
600	600	502	593	1 pc(s).	9683.666
600	800	502	793	1 pc(s).	9683.668
800	1000	702	993	1 pc(s).	9683.680
800	150	702	143	1 pc(s).	9683.681
800	200	702	193	1 pc(s).	9683.682
800	300	702	293	1 pc(s).	9683.683
800	400	702	393	1 pc(s).	9683.684
800	600	702	593	1 pc(s).	9683.686
800	800	702	793	1 pc(s).	9683.688
1000	400	902	393	1 pc(s).	9683.604
1000	600	902	593	1 pc(s).	9683.606
1000	800	902	793	1 pc(s).	9683.608
1200	400	1102	393	1 pc(s).	9683.624
1200	600	1102	593	1 pc(s).	9683.626
1200	800	1102	793	1 pc(s).	9683.628

Design with gland made from insulating material

For enclosure width mm	For compartment height mm	Width mm	Height mm	Packs of	Model No.
600	150	502	143	1 pc(s).	9683.561
600	200	502	193	1 pc(s).	9683.562
600	300	502	293	1 pc(s).	9683.563
600	400	502	393	1 pc(s).	9683.564



Power distribution

Compartment configuration

Form 1-4



Support frame

for DIN rail-mounted devices

Support frame set for accepting DIN rail-mounted devices (e.g. MCBs). The support rails are fastened with two mounting brackets to the compartment side panel. The cover is fastened to the support frame with knurled screws. In combination with functional space dividers, partial mounting plates and side panel modules, internal compartmentalisation in accordance with Form 2, 3 or 4 is possible.

Material:

- Support frame: Sheet steel, zinc-plated, passivated, 1.5 mm
- Cover: Sheet steel, spray finished, 1.5 mm

Supply includes:

- Support rails
- 2 mounting brackets
- 1 cover with cut-out
- Assembly parts

For enclosure width mm	For compartment height mm	No. of pitch units 17.5 mm	Packs of	Model No.
600	300	2 x 24	1 pc(s).	9683.763
800	300	2 x 36	1 pc(s).	9683.783

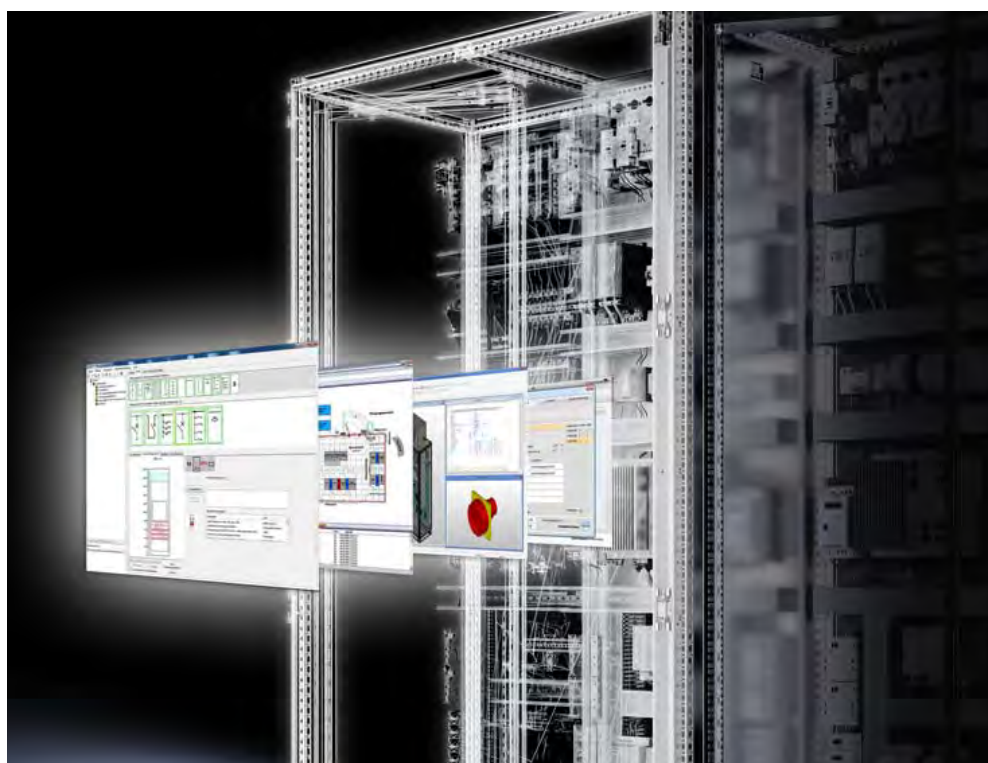

Certainty for engineering: optimum conversion and planning tools, see page 1160

Fuse-switch disconnecter section

Busbar support

for fuse-switch disconnecter section

Busbar supports for the distribution busbar system of the fuse-switch disconnecter section.

Material:

- Duroplastic polyester

Supply includes:

- Mounting bracket and screws

For busbars mm	Number of poles	Packs of	Model No.
60 x 10	3-pole 4-pole	1 pc(s).	9674.416
80 x 10	3-pole 4-pole	1 pc(s).	9674.418
100 x 10	3-pole 4-pole	1 pc(s).	9674.410



Also required:

- Busbars E-Cu, see page 342
- End support, see page 415

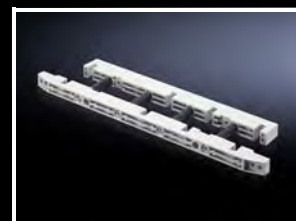

End support

for fuse-switch disconnecter section

End support for the distribution busbar system of the fuse-switch disconnecter section, for vertical support of the distribution busbar system with infeed from above.

Material:

- Duroplastic polyester

Supply includes:

- Mounting bracket and screws

For busbars mm	Number of poles	Packs of	Model No.
60 x 10	3-pole 4-pole	1 pc(s).	9674.436
80 x 10	3-pole 4-pole	1 pc(s).	9674.438
100 x 10	3-pole 4-pole	1 pc(s).	9674.430



Also required:

- Busbars E-Cu, see page 342



Cover

Set for distribution busbar

(Jean Müller fuse-switch disconnecter section)

To cover the distribution busbar system of a fuse-switch disconnecter section, designed to accommodate Jean Müller devices. The 150 mm high busbar and cable connection space covers shield the busbar compartment from the functional space so that it is safe from finger contact, with a protection category of IP 20.

Material:

- PVC, black

Supply includes:

- Set consisting of 12 busbar covers and cable connection space covers

For enclosure height mm	Packs of	Model No.
2000 2200	1 pc(s).	9674.380



Also required:

- Punched rail, see page 416



Fuse-switch disconnecter section



Punched rail

**Set for cover, distribution busbar
(Jean Müller fuse-switch disconnecter section)**
Required for mounting the distribution busbar cover.

Material:

- Sheet steel, zinc-plated

Supply includes:

- Set consisting of 2 punched rails
- Assembly parts

Note:

- For 1 fuse-switch disconnecter section, 1 pack of punched rails is required.

For enclosure height mm	Packs of	Model No.
2000 2200	1 pc(s).	9674.381

Cover

**for distribution busbar
(ABB/Siemens fuse-switch disconnecter section)**

To cover the distribution busbar system of a switch-disconnector-fuse section, designed to accommodate ABB (SlimLine) or Siemens (3NJ62) devices. The 200 mm high busbar compartment covers shield the busbar compartment from the functional space so that it is safe from finger contact, with a protection category of IP 20.

Material:

- PVC, black

Note:

- The cover may be ordered from ABB under model number NHP 407062R000X
- For enclosure height 2000 mm, a height of 1500 mm should be covered, and for enclosure height 2200 mm, a height of 1700 mm should be covered

Ri4Power accessories

Busbar system/wiring system

Copper spacer roll

for Maxi-PLS busbars and flat copper bars

For use as a universal spacer.

Material:

- E-Cu

Height mm	Diameter mm	Hole Ø mm	Packs of	Model No.
20	30	13	4 pc(s).	9676.503
20	40	13	4 pc(s).	9676.504
20	50	13	4 pc(s).	9676.505



Wiring trim panel

for VX

Inner front cover of the main busbar system with the option of mounting a 40 x 20 mm (WxD) wiring channel. Suitable for use in Ri4Power switchgear with 300 mm high front trim panels. Horizontal cable routing behind the front trim panels. Also supports the installation of support rails with DIN rail mounted devices.

Material:

- Sheet steel

Surface finish:

- Zinc-plated

Supply includes:

- 1 wiring trim panel, 3-part
- Assembly parts

Note:

- For vertical cable routing, compartment dividers enable the installation of a wiring channel, thanks to pre-punched cut-outs.

For enclosure width mm	Packs of	Model No.
600 800	1 pc(s).	9683.736
1000 1200	1 pc(s).	9683.738



Rittal – The System.

Faster – better – everywhere.

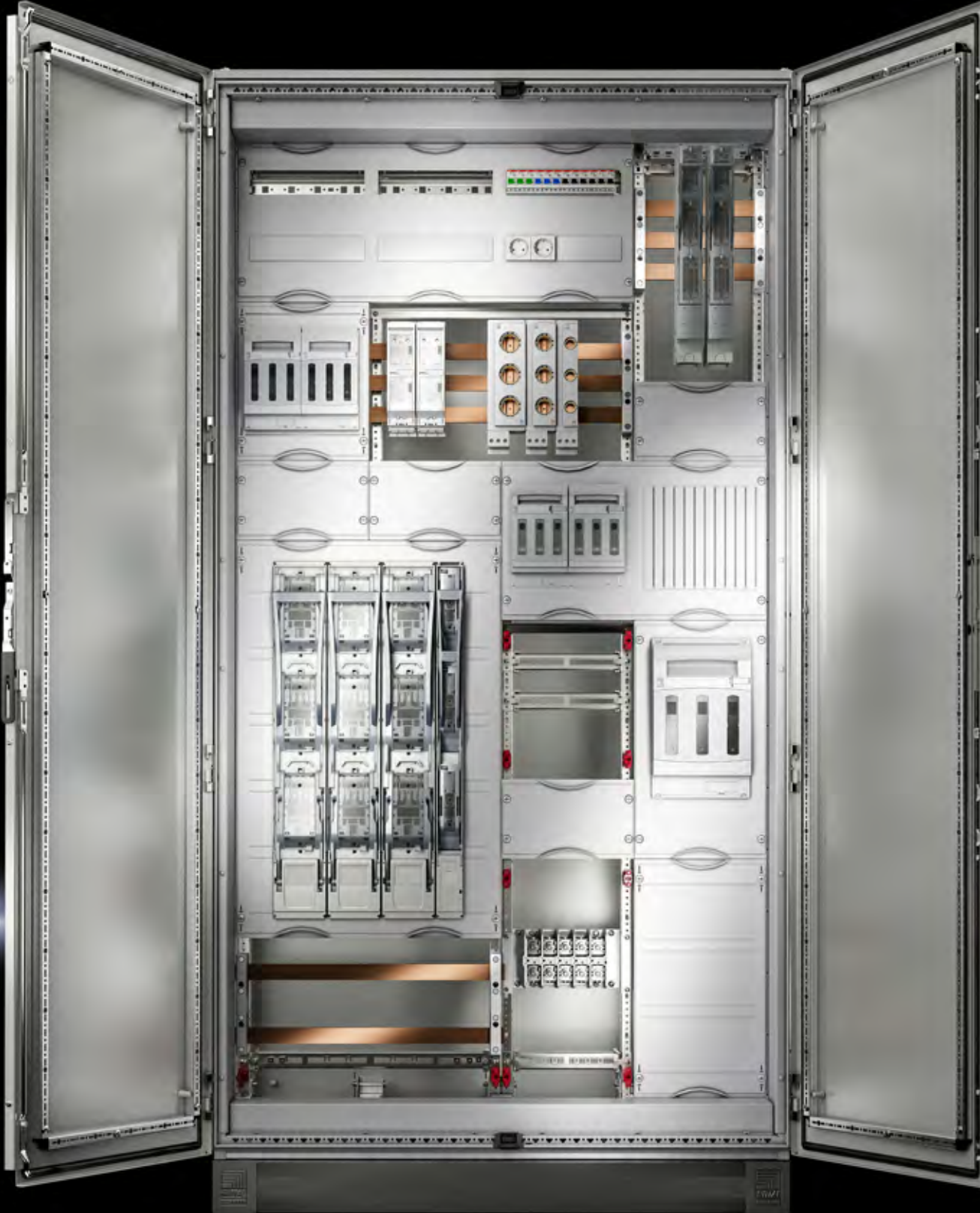

VX25 Ri4Power ISV distribution enclosures

Distribution enclosures

- Based on baying enclosure system VX25, see page 116
- Mounting kits, see page 420

Wall-mounted distributors

- Based on compact enclosure AX, see page 84
- Mounting kits, see page 420

Installation modules

- Easy mounting on support frame or support plate
- Individual combination and configuration
- Pitch pattern 150 x 250 mm
- Installation modules, see page 421

Power distribution components

- Bus-mounting fuse bases, see page 323
- NH fuse-switch disconnectors, see page 325
- NH slimline fuse-switch disconnectors, see page 335



Power distribution



ISV distribution enclosures

Mounting kits



ISV installation kit

for VX

For mounting ISV installation modules in the enclosure.

Material:

- Mounting frame holder: Sheet steel, zinc-plated
- Contact hazard protection: sheet steel, spray-finished
- Contact hazard protection, sides: PVC

Supply includes:

- Mounting aid support
- Contact hazard protection
- Assembly parts



Accessories:

- Cross rail ISV, see page 429
- Mounting angles ISV, see page 429
- Depth stay, see page 430
- Equipment support connectors, see page 430

For enclosure width mm	For enclosure height mm	For enclosure depth mm	Width units (WU) @ 250 mm	Height units (U) @ 150 mm	To fit Model No.	Note on Model No.	Packs of	Model No.
600	1800	400 500 600	2	11	8457.000/ 8684.000/ 8685.000/ 8686.000	Mounting angle 9666.711 and mounting plate 8612.400 are additionally required	1 pc(s).	9666.932
600	2000	400 500 600	2	12	8452.000/ 8604.000/ 8605.000/ 8606.000	Mounting angle 9666.712 and mounting plate 8612.400 are additionally required	1 pc(s).	9666.902
850	2000	400 600	3	12	9666.916/ 9666.956	Mounting angle 9666.712 and mounting plate 8612.400 are additionally required	1 pc(s).	9666.912
1100	2000	400 600	4	12	9666.926/ 9666.966	Mounting angle 9666.712, depth stay 9666.732 and mounting board 8612.400 are additionally required	1 pc(s).	9666.922



ISV installation kit

for AX

For mounting ISV installation modules in enclosures.

Material:

- Assembly kit: Sheet steel, zinc-plated
- Support rail: Sheet steel, zinc-plated
- Contact hazard protection: Sheet steel, spray-finished

Supply includes:

- Assembly kit
- Support rails
- Contact hazard protection
- Assembly parts



Also required:

- Mounting angles ISV, see page 429

For enclosure width mm	For enclosure height mm	For enclosure depth mm	Width units (WU) @ 250 mm	Height units (U) @ 150 mm	To fit Model No.	Packs of	Model No.
380	600	210	1	3	1008.X00/ 1038.X00	1 pc(s).	9666.801
500	700	250	1	4	1057.X00	1 pc(s).	9666.811
600	760	210	2	4	1012.X00/ 1076.X00	1 pc(s).	9666.821
600	1000	250	2	6	1090.X00	1 pc(s).	9666.831
600	1200	300	2	7	1260.X00	1 pc(s).	9666.841
1000	1200	300	3	7	1019.X00/ 1213.X00/ 1305.X00	1 pc(s).	9666.851

ISV distribution enclosures

Installation modules

Contact hazard protection module

For covering free installation areas. Cover is prepared for a lead seal.

Material:

– Cover: Polystyrene

Colour:

– RAL 7035

Supply includes:

– Assembly parts

Width mm	Height mm	Width units (WU) @ 250 mm	Height units (U) @ 150 mm	Packs of	Model No.
250	150	1	1	1 pc(s).	9666.000
250	300	1	2	1 pc(s).	9666.010
250	450	1	3	1 pc(s).	9666.020
250	600	1	4	1 pc(s).	9666.030
500	150	2	1	1 pc(s).	9666.040
500	300	2	2	1 pc(s).	9666.050
500	450	2	3	1 pc(s).	9666.060
500	600	2	4	1 pc(s).	9666.070
750	300	3	2	1 pc(s).	9666.053
750	450	3	3	1 pc(s).	9666.063
750	600	3	4	1 pc(s).	9666.073

Mounting plate module

Possible installation depth 105 - 140 mm. Cover is prepared for a lead seal.

Material:

– Cover: Polystyrene
– Mounting plate: Sheet steel, zinc-plated

Colour:

– RAL 7035

Supply includes:

– Assembly parts

Width mm	Height mm	Width units (WU) @ 250 mm	Height units (U) @ 150 mm	Dimensions mounting plate (W x H) mm	Packs of	Model No.
250	150	1	1	188 x 116	1 pc(s).	9666.080
250	300	1	2	188 x 266	1 pc(s).	9666.090
250	450	1	3	188 x 416	1 pc(s).	9666.100
250	600	1	4	188 x 566	1 pc(s).	9666.110
500	150	2	1	438 x 116	1 pc(s).	9666.120
500	300	2	2	438 x 266	1 pc(s).	9666.130
500	450	2	3	438 x 416	1 pc(s).	9666.140
500	600	2	4	438 x 566	1 pc(s).	9666.150
750	300	3	2	688 x 266	1 pc(s).	9666.133
750	450	3	3	688 x 416	1 pc(s).	9666.143

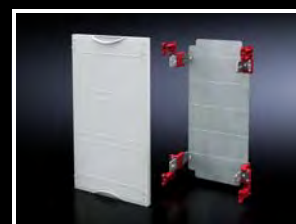

ISV distribution enclosures

Installation modules

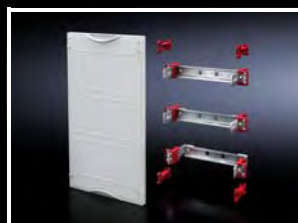

Support rail module

For installing terminal blocks, switchgear, etc. with support rails 35 x 15 mm. Adjustable on a 25 mm pitch pattern. Cover is prepared for a lead seal.

Material:

- Cover: Polystyrene
- Support rail: Sheet steel, zinc-plated

Colour:

- RAL 7035

Supply includes:

- Assembly parts



Accessories:

- Wiring bracket, see page 428

Width mm	Height mm	Width units (WU) @ 250 mm	Height units (U) @ 150 mm	Number of support rails	Packs of	Model No.
250	150	1	1	1	1 pc(s).	9666.160
250	300	1	2	2	1 pc(s).	9666.170
250	450	1	3	3	1 pc(s).	9666.180
250	600	1	4	4	1 pc(s).	9666.190
500	150	2	1	1	1 pc(s).	9666.200
500	300	2	2	2	1 pc(s).	9666.210
500	450	2	3	3	1 pc(s).	9666.220
500	600	2	4	4	1 pc(s).	9666.230
750	300	3	2	2	1 pc(s).	9666.213
750	450	3	3	3	1 pc(s).	9666.223

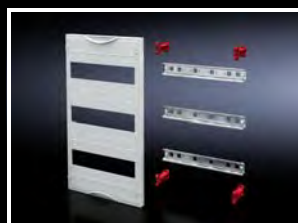

DIN rail mounted device module

To accommodate DIN rail mounted devices. With support rails 35 x 15 mm. Cover is prepared for a lead seal.

Material:

- Cover: Polystyrene
- Support rail: Sheet steel, zinc-plated

Colour:

- RAL 7035

Supply includes:

- Assembly parts



Accessories:

- Cover strip, see page 428

Width mm	Height mm	Width units (WU) @ 250 mm	Height units (U) @ 150 mm	Max. pitch units @ 18 mm	Number of cut-outs	Number of support rails	Packs of	Model No.
250	150	1	1	12	1	1	1 pc(s).	9666.240
250	300	1	2	24	2	2	1 pc(s).	9666.250
250	450	1	3	36	3	3	1 pc(s).	9666.260
250	600	1	4	48	4	4	1 pc(s).	9666.270
500	150	2	1	24	2	1	1 pc(s).	9666.280
500	300	2	2	48	4	2	1 pc(s).	9666.290
500	450	2	3	72	6	3	1 pc(s).	9666.300
750	300	3	2	72	6	2	1 pc(s).	9666.293
750	450	3	3	108	9	3	1 pc(s).	9666.303

ISV distribution enclosures

Installation modules

Connection terminal block

For connecting copper and aluminium conductors.
For laminated copper bars or solid and stranded conductors with a pressed wire end ferrule.

Material:

- Duroplastic

Colour:

- RAL 7035

Supply includes:

- Assembly parts

**Also required:**

- Contact hazard protection module, see page 421
- Mounting set, see page 423

**Assembly instruction:**

- Contact hazard protection module 9666.020 is additionally required to cover the connection terminal block



Rated current max. A	Number of poles	Connection of round conductors mm ²	Clamping area for laminated copper bars (W x H) mm	Packs of	Model No.
250	5-pole	16 - 150 2 x 16 - 70	17 x 21	1 pc(s).	9666.340
400	5-pole	50 - 240 2 x 25 - 120	25 x 21	1 pc(s).	9666.350

Mounting set

for connection terminal block

For attaching the connection terminal block to the frame of the ISV installation kit.

Material:

- Sheet steel, zinc-plated

Supply includes:

- Assembly parts



Width units (WU) @ 250 mm	Height units (U) @ 150 mm	Packs of	Model No.
1	3	1 pc(s).	9666.310

ISV distribution enclosures

Installation modules



NH fuse-switch-disconnector module

Suitable for accommodating NH fuse-switch disconnectors for mounting plate assembly. Cover is prepared for a lead seal.

Material:

- Cover: Polystyrene
- Cross member: Sheet steel

Colour:

- RAL 7035

Supply includes:

- Assembly parts

 **Assembly instruction:**

- When using the NH fuse-switch disconnector 2 x size 2 (9344.210/.230/.250) or 1 x size 3 (9344.310/.330/.350), the disconnector cross-member 9666.420 and contact hazard protection module 9666.060 should be used as the module unit

 **Accessories:**

- Blanking cover, see page 428

Width mm	Height mm	Width units (WU) @ 250 mm	Height units (U) @ 150 mm	For size	To fit Model No.	Packs of	Model No.
250	300	1	2	2 x size 00	9344.000/ 9344.010/ 9344.020/ 9344.030/ 9344.040/ 9344.050	1 pc(s).	9666.380
500	300	2	2	4 x size 00	9344.000/ 9344.010/ 9344.020/ 9344.030/ 9344.040/ 9344.050	1 pc(s).	9666.390
250	450	1	3	1 x size 1	9344.100/ 9344.110/ 9344.130/ 9344.150	1 pc(s).	9666.400
250	450	1	3	1 x size 2	9344.210/ 9344.230/ 9344.250	1 pc(s).	9666.410



Disconnector cross member

for NH fuse-switch disconnectors

Suitable for accommodating NH fuse-switch disconnectors for mounting plate assembly.

Material:

- Sheet steel

Supply includes:

- Assembly parts

Note:

- When using the disconnector cross-member, contact hazard protection module 9666.060 is additionally required

 **Also required:**

- Contact hazard protection module, see page 421

Width mm	Height mm	Width units (WU) @ 250 mm	Height units (U) @ 150 mm	For size	To fit Model No.	Packs of	Model No.
500	450	2	3	2 x size 2 1 x size 3	9344.210/ 9344.230/ 9344.250/ 9344.310/ 9344.330/ 9344.350	1 pc(s).	9666.420

ISV distribution enclosures

Installation modules

NH slimline fuse-switch-disconnector module

For NH slimline fuse-switch disconnectors, sizes 00 to 3 (3-pole, 100/185 mm bar centre distance).

Material:

- Cover: Polystyrene
- Holder: Fibreglass-reinforced plastic

Colour:

- RAL 7035

Supply includes:

- Assembly parts

Note:

- In order to ensure problem-free cable connection, a contact hazard protection module or an N/PE busbar module must be installed above or below the NH slimline fuse-switch disconnector modules.



Also required:

- Busbars E-Cu, see page 342



Accessories:

- Contact hazard protection module, see page 421
- Busbar module N/PE, see page 426

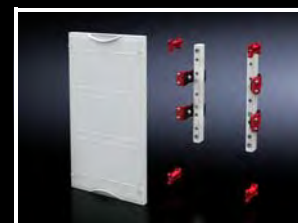

Width mm	Height mm	Width units (WU) @ 250 mm	Height units (U) @ 150 mm	For size	To fit Model No.	For busbar mm	Bar centre distance mm	Packs of	Model No.
250	450	1	3	3 x size 00	9346.020/ 9346.030	40 x 10	100	1 pc(s).	9666.570
500	450	2	3	6 x size 00	9346.020/ 9346.030	40 x 10	100	1 pc(s).	9666.580
500	750	2	5	8 x size 00 4 x size 1 4 x size 2 4 x size 3	9677.XXX	60 x 10	185	1 pc(s).	9666.550
750	450	3	3	10 x size 00	9346.020/ 9346.030	40 x 10	100	1 pc(s).	9666.583
750	750	3	5	12 x size 00 6 x size 1 6 x size 2 6 x size 3	9677.XXX	60 x 10	185	1 pc(s).	9666.560

Circuit-breaker module

Suitable for accommodating standard moulded-case circuit-breakers from ABB, Eaton, Schneider Electric and Siemens. Cover is prepared for a lead seal.

Material:

- Cover: Polystyrene
- Support rail: Sheet steel, zinc-plated

Colour:

- RAL 7035

Supply includes:

- Assembly parts

Width mm	Height mm	Width units (WU) @ 250 mm	Height units (U) @ 150 mm	For switchgear make (model)	Packs of	Model No.
250	300	1	2	ABB (T1, T2, T3) Eaton (NZM1, NZM2, BZM B1, BZM B2) Schneider Electric (NSX100, NSX160, NSX250) Siemens (3RV13 53, VL160(X), VL250, VT1, VT2)	1 pc(s).	9666.430
500	450	2	3	ABB (T4, T5) Eaton (NZM3) Schneider Electric (NSX400, NSX630) Siemens (3RV1.6., 3RV1.7., VL400, VL630, VT3)	1 pc(s).	9666.440



ISV distribution enclosures

Installation modules

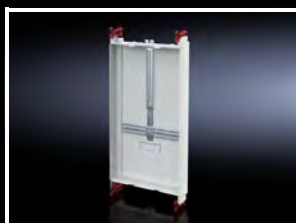

Meter mounting board module

Open module for internal measurements. Clearance depth available for meter installation 170 mm.

Design:

- Attachment rails to accommodate a meter

Material:

- Meter mounting board: Polystyrene
- Mounting rails: sheet steel, zinc-plated

Colour:

- RAL 7035

Supply includes:

- Assembly parts

Note:

- The meter mounting board module does not comply with meter mounting board standard DIN 43 870/VDE 0603 and does not meet the conditions for total insulation. Use in unmetered areas only by arrangement with the local electricity supply company.

 **Assembly instruction:**

- 1 contact hazard protection module / DIN rail-mounted device module or support rail module with 1 WU and at least 1 U is required both above and below the meter mounting board module

 **Accessories:**

- Contact hazard protection module, see page 421
- Support rail module, see page 422
- DIN rail mounted device module, see page 422

Width mm	Height mm	Width units (WU) @ 250 mm	Height units (U) @ 150 mm	Packs of	Model No.
250	450	1	3	1 pc(s).	9666.640



Busbar module N/PE

For attaching busbars 12 x 5/10 mm, 20 x 5/10 and 30 x 5/10 mm for N and PE. Cover is prepared for a lead seal.

Material:

- Cover: Polystyrene
- Holder: Fibreglass-reinforced plastic
- Support rail: Sheet steel, zinc-plated

Colour:

- RAL 7035

 **Also required:**

- Busbars E-Cu, see page 342

Width mm	Height mm	Width units (WU) @ 250 mm	Height units (U) @ 150 mm	Packs of	Model No.
250	300	1	2	1 pc(s).	9666.590
500	300	2	2	1 pc(s).	9666.600
750	300	3	2	1 pc(s).	9666.603

ISV distribution enclosures

Installation modules

Busbar module

for fuse elements

For assembling bus-mounting fuse bases E18, E27, E33 and D-Switch as well as NH fuse-switch disconnectors, sizes 000 and 00 (3-pole, 60 mm bar centre distance).

Material:

- Cover: Polystyrene
- Holder: Fibreglass-reinforced plastic

Colour:

- RAL 7035

Supply includes:

- Assembly parts



Also required:

- Busbars E-Cu, see page 342



Accessories:

- Blanking cover, see page 428



Width mm	Height mm	Width units (WU) @ 250 mm	Height units (U) @ 150 mm	To fit Model No.	For busbar mm	Packs of	Model No.
250	300	1	2	3418.010/ 3427.010/ 3433.010/ 3431.020/ 3431.030/ 3431.035/ 9340.950/ 9343.000/ 9343.020/ 9343.040	30 x 10	1 pc(s).	9666.520
500	300	2	2	3418.010/ 3427.010/ 3433.010/ 3431.020/ 3431.030/ 3431.035/ 9340.950	30 x 10	1 pc(s).	9666.530
750	300	3	2	3418.010/ 3427.010/ 3433.010/ 3431.020/ 3431.030/ 3431.035/ 9340.950	30 x 10	1 pc(s).	9666.533

ISV distribution enclosures

Accessories



Cover strip

for DIN rail mounted device module

For sealing unused component cut-outs in DIN rail mounted device modules, max. 12 pitch units (12 x 18 mm), divisible every 9 mm.

Material:

– ABS

Colour:

– RAL 7035

Packs of	Model No.
5 pc(s).	9666.650



Blanking cover

for busbar module

For sealing unused cut-outs. Width: 16 – 34 mm, variable.

Material:

– Polypropylene

Colour:

– RAL 7035

Width mm	To fit Model No.	Packs of	Model No.
34	9666.520/ 9666.530/ 9666.533	10 pc(s).	9666.660



Blanking cover

for NH fuse-switch-disconnector module

For sealing unused cut-outs (size 00).

Material:

– PVC

Colour:

– RAL 7035

Width mm	To fit Model No.	Packs of	Model No.
117	9666.380/ 9666.390	1 pc(s).	9666.665



Wiring bracket

For tool-free attachment to the support rail 35 x 15 mm, for cable entry at the rear of support rail modules.

Material:

– Polyamide

Packs of	Model No.
10 pc(s).	9666.670

ISV distribution enclosures

Accessories

Depth extension frame

for NH fuse-switch disconnectors size 00

For extending the depth of the contact hazard protection cover. Allows unrestricted connection of NH fuse-switch disconnectors, size 00 (3-pole, 60 mm bar centre distance).

Material:

– Polystyrene

Colour:

– RAL 7035

Supply includes:

– Assembly parts

Note:

– NH fuse-switch disconnectors size 00 with covers and depth extension frame cannot be used in conjunction with other equipment

Width mm	Height mm	Width units (WU) @ 250 mm	Height units (U) @ 150 mm	Packs of	Model No.
250	300	1	2	1 pc(s).	9666.680



Cross rail ISV

for VX

For horizontal sub-division of the support frame in the enclosure.

Material:

– Sheet steel

Surface finish:

– Zinc-plated

Width mm	Width units (WU) @ 250 mm	Packs of	Model No.
500	2	2 pc(s).	9666.722
750	3	2 pc(s).	9666.723
1000	4	2 pc(s).	9666.724



Mounting angles ISV

for VX

For vertical sub-division of the support frame in the enclosure.

Material:

– Sheet steel

Surface finish:

– Zinc-plated

Height mm	Height units (U) @ 150 mm	Packs of	Model No.
300	2	2 pc(s).	9666.702
450	3	2 pc(s).	9666.703
600	4	2 pc(s).	9666.704
750	5	2 pc(s).	9666.705
900	6	2 pc(s).	9666.706
1050	7	2 pc(s).	9666.707
1650	11	2 pc(s).	9666.711
1800	12	2 pc(s).	9666.712



Accessories:

– Equipment support connectors, see page 430

Mounting angles ISV

for AX

For vertical sub-division of the support frame in the enclosure.

Material:

– Sheet steel

Surface finish:

– Zinc-plated

Height mm	Height units (U) @ 150 mm	Packs of	Model No.
450	3	2 pc(s).	9666.753
600	4	2 pc(s).	9666.754
900	6	2 pc(s).	9666.756
1050	7	2 pc(s).	9666.757



ISV distribution enclosures

Accessories



Depth stay

for installation kit ISV

For attaching the installation kit in the enclosure.

Material:

- Sheet steel

Surface finish:

- Zinc-plated

Supply includes:

- Assembly parts

For enclosures	For enclosure depth mm	To fit Model No.	Packs of	Model No.
VX	400 500 600	9666.902/ 9666.912/ 9666.922/ 9666.932	2 pc(s).	9666.732



Equipment support connectors

for mounting angles ISV

For connecting 2 mounting angles. Increases the stability of the frame structure.

Material:

- T-section: Aluminium

Supply includes:

- Assembly parts

To fit Model No.	Packs of	Model No.
9666.702/ 9666.703/ 9666.704/ 9666.705/ 9666.706/ 9666.707/ 9666.711/ 9666.712	4 pc(s).	9666.740

Wall-mounted distributor

Based on compact enclosure AX, see page 78



Rittal Energy and Power Solutions

End-to-end solutions from generation to consumer

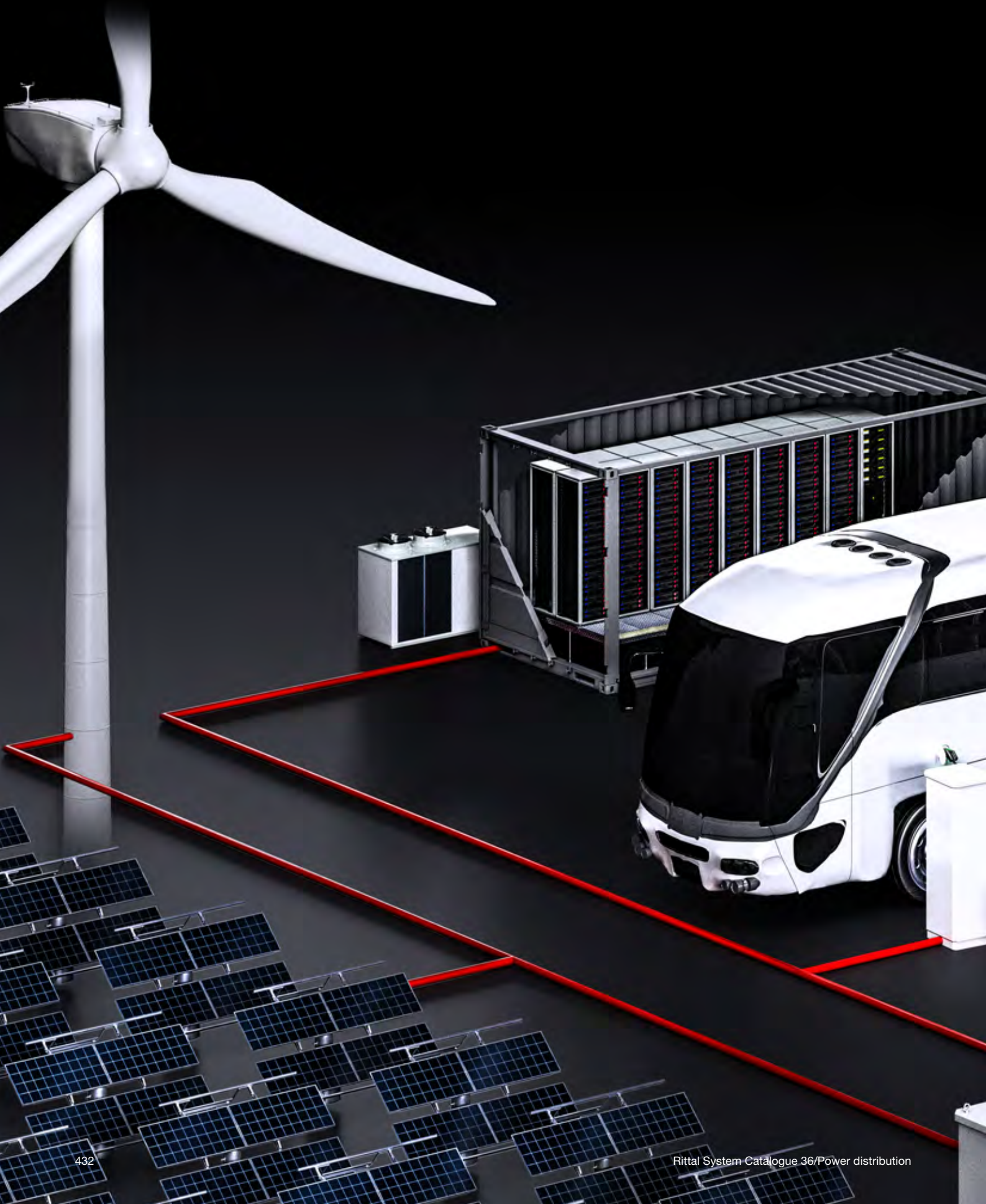

Renewable energies

- Reliable energy generation and infeed, together with smart connectivity, are the key to the new energy world, where energy solutions must transcend individual sectors.
- There is a demand for solutions with global availability and internationally recognised approvals plus effective protection from a wide range of ambient conditions.
- Plant and systems engineering needs solutions to create significant competitive advantages through energy efficiency plus time and money savings.



Power distribution

Energy storage solutions

- Battery stores can help to stabilise the power supply in the renewable energies environment, e.g. by means of peak load management, frequency retention and an uninterruptible power supply (UPS).
- The different battery module designs available on the market necessitate a variable solution for building energy storage systems. The standardised modular system offers the required degree of variability and supports the integration of 482.6 mm (19") battery types and other variants using rails and heavy-duty shelves.
- The range of products includes indoor, outdoor and even container solutions. Our standard products will help to reduce your planning and production costs.



Charging infrastructure

- Charging centres generally comprise a scalable number of charging pillars, the requisite backend infrastructure, plus a low-voltage main distributor.
- We usually distinguish between normal charging in the range < 50 kW (primarily AC technology), fast charging from 50 kW upwards, and high-power charging > 150 kW (DC technology).



Renewable energies

Flexible enclosure solutions for wind power and photovoltaics



Rotor hub / nacelle

- Rittal provides suitable enclosure and case systems for all areas of wind farms, based on impressive modular technology.
- Control cabinets in the nacelle and pitch enclosure directly in the rotor hub, to reliably withstand even the highest dynamic forces

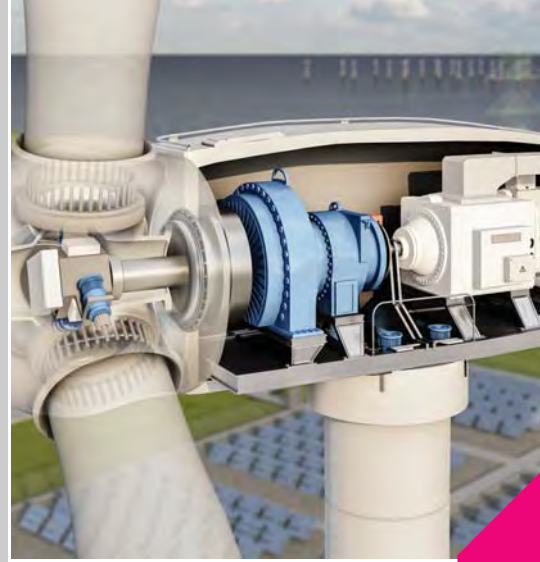

Tower

- The components we use are modular, efficient and low-maintenance, for fast (and in some cases, customised) configuration.
- Complete system solutions for powerful frequency converters including climate control



Power distribution

Central inverter

- There is a growing use of inverter systems under difficult ambient conditions.
- Smart standard solutions offer a high level of physical protection for the enclosure, equipped with power distributor and climate control.



Solar panel

- Compact enclosures in the AX and KX series are ideal for housing the electronics for solar tracking systems or as a general junction box. The small and compact enclosures offer simpler, faster assembly coupled with greater flexibility and security.



Renewable energies



Application		Enclosure	
System solution		<p>Rittal enclosure solutions provide optimum protection for your components.</p> <ul style="list-style-type: none"> ■ Protection category-tested enclosure technology to IP, IK, RC ■ Accredited in-house laboratory ■ 3-phase surface treatment for maximum corrosion protection ■ Choice of materials depending on the climate and requirement profile: Aluminium, stainless steel, sheet steel ■ EMC protection ■ Static load capacity up to 14,000 N 	
		Requirements	
Wind energy	Rotor hub	<ul style="list-style-type: none"> ■ Dynamic loads ■ Walkable ■ Easy access 	<ul style="list-style-type: none"> ■ Small and compact enclosures, material: sheet steel, stainless steel, from page 43
	Nacelle	<ul style="list-style-type: none"> ■ Dynamic loads ■ Thermal management ■ Prevent condensation 	<ul style="list-style-type: none"> ■ Large enclosure, material: Sheet steel, from page 116
	Tower	<ul style="list-style-type: none"> ■ Confined space ■ Thermal management 	<ul style="list-style-type: none"> ■ Large enclosure, material: Sheet steel, from page 116
Photovoltaics	Central inverter	<ul style="list-style-type: none"> ■ Weather influences ■ Environmental conditions 	<ul style="list-style-type: none"> ■ Large outdoor enclosure, material: Stainless steel, aluminium, from page 268
	Solar panel		<ul style="list-style-type: none"> ■ Small enclosure/PK, material: Plastic, sheet steel, from page 43



Power distribution

	Climate control	Power distribution	Accessories	Quality management
	<p>Efficient, innovative climate control solutions provide reliable protection for your power electronics.</p> <ul style="list-style-type: none"> ■ Fans, cooling units and heaters for temperature control of the built-in equipment. ■ Individual design of the required climate control using our Therm software 	<p>Rittal offers a modular system for demand-based power distribution (from page 277).</p> <ul style="list-style-type: none"> ■ Distribution and protection of the power supply focussing on standardisation and availability ■ Planning and design of low-voltage switchgear to IEC 61 439 with design certificate using Power Engineering software 		<p>Rittal will support you from day one:</p> <ul style="list-style-type: none"> ■ Project planning of technical specifications ■ Prototype assembly, testing and simulations ■ Manufacturing and assembly ■ Warehousing service and on-time delivery ■ Your own personal point of contact throughout the entire project
	<ul style="list-style-type: none"> ■ Fan-and-filter units with protection category IP 54 as standard. More products from page 456 ■ Fan-and-filter units and Blue e+ (energy-efficient) More products from page 456 ■ Roof-mounted cooling unit; doors or side panels and escape routes are kept free More products from page 498 ■ TopTherm Blue e wall-mounted cooling unit, NEMA 4X, also as IloT bundle ■ Outdoor cooling unit, from page 496 More products from page 477 ■ Fan-and-filter units ■ Thermoelectric coolers More products from page 456 	<ul style="list-style-type: none"> ■ Modular system for low-voltage switchgear with design verification to IEC 61 439 up to 1600 A for DC and AC applications, from page 446 ■ Rated current < 125 A RiLine Compact, from page 285 ■ Rated current < 250 A Mini-PLS, from page 294 ■ Rated current < 1600 A RiLine PLS, from page 300 ■ Rated current < 6300 A VX25 Ri4Power, from page 314 	<ul style="list-style-type: none"> ■ Earthquake kit, from page 1032 ■ EMC, from page 1028 ■ Monitoring, from page 799 ■ IoT interface, from page 554 ■ Base/plinths, from page 880 ■ Lock systems, from page 933 ■ Rain canopies, from page 958 ■ Interior installation, mounting plates, bar systems, from page 970 ■ Industry-specific accessories available on request 	<p>Accredited Rittal test laboratory</p> <ul style="list-style-type: none"> ■ Simulation of climatic conditions ■ Dynamic and static load tests ■ 3D measurement ■ Corrosion testing ■ Electrical safety and function tests ■ Software tests ■ Performance testing of chillers, cooling units and heat exchangers

Energy Storage Solutions (ESS)

The perfect system solution for every storage task



Heavy-duty shelves for loads up to 100 kg per level

- Rittal's modular product system includes standard components for flexible assembly of an infrastructure with a battery energy storage system (BESS).
- Battery types not compliant with the 482.6 mm (19") standard may be integrated, e.g. using heavy-duty shelves with a load-bearing capacity of up to 100 kg.

Integration with the 482.6 mm (19") rack mounting system

- The technology behind the 482.6 mm (19") standard is exceptionally assembly-friendly and supports simple integration of these battery types.
- For larger battery capacities, Rittal enclosures may be bayed.

Efficient monitoring

- For seamless monitoring of performance and risk of failure, ESS may be combined with CMC and RiZone for the monitoring system.
- Web connectivity is provided via the Rittal IoT interface.

Efficiency in plant design

- Lithium ion batteries have a specific thermal operating window which must be observed for safety reasons. Depending on the installation site and use of the system, therefore, a range of design features from active ventilation through to climate control may be required.
- Rittal offers FEM and CFD analyses to represent your individual project in its specific situation, so that you can gauge which concepts are viable and which are not.



Power distribution

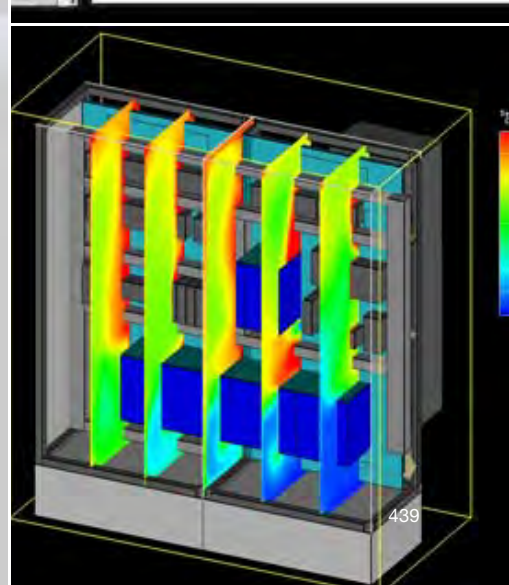
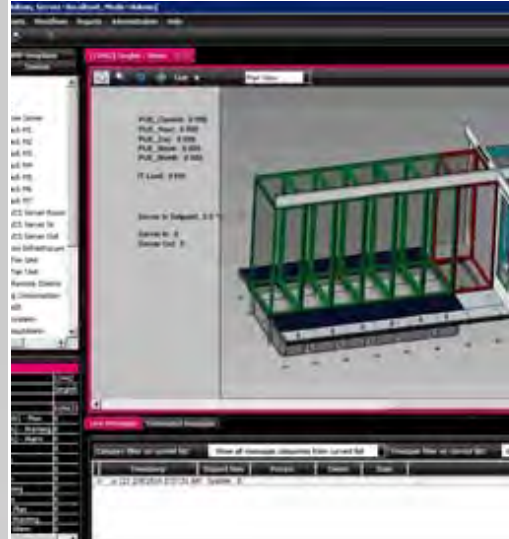

Energy storage solutions



Type	Enclosures			Climate control	
	VX25 rack system	Outdoor enclosure system	Container	Wall-mounted cooling unit Blue e+	Roof-mounted cooling unit Blue e+
System solution	The modular VX25 enclosure system is available in a range of sizes, both as a standalone rack and as a bayable solution. Our extensive range of accessories supports a broad range of solutions. With a weight capacity of 1500 kg, all standard battery types may be integrated.	Identical system platform in the outdoor sector as for IE or IT enclosure systems. Additionally with weather canopy, with projection on all sides. The double-walled design reduces the influence of sunlight. The open frame structure offers installation benefits. Also available as a baying variant.	On a project-specific basis, we offer 20ft and 40ft containers with up to 18/36 bays. Where required, these may be designed with suitable climate control.	Our energy-efficient Blue e+ wall-mounted cooling units ensure the correct temperature inside the enclosure. The outputs range from 1.6 to 6 kW. Their unique multi-voltage capability makes them suitable for international use. The cooling units are IoT-compatible and support modern condition monitoring.	Our energy-efficient Blue e+ roof-mounted cooling units ensure the correct temperature inside the enclosure. The output is 1.3 kW. Their unique multi-voltage capability makes them suitable for international use. The cooling units are IoT-compatible and support modern condition monitoring.
Approvals	CSA, DNV-GL, UL and C-UL	–		CE, TÜV-tested safety, UL/cUL, UL/cUL-FTTA, EAC	CE, TÜV-tested safety, UR/cUR, EAC
482.6 mm (19') configuration	Indoor	■	–	■	■
	Outdoor	–	■	–	–
Heavy-duty shelf	Indoor	■	–	■	■
	Outdoor	–	■	–	–
From page	116	263	On request	486	504



	Climate control	Power distribution	Interior installation	Accessories	
	Outdoor cooling unit	Busbars	Component shelf for frame attachment	Adaptor section, 482.6 mm (19')	Slide rails, static installation for VX IT
	Useful cooling output 1500 W, temperature control via e+ controller on the rear of the cooling unit. For universal attachment to outdoor enclosures for external, partial internal and full internal mounting. Average 75% energy savings thanks to speed-regulated components and heat pipe technology. Multi-voltage capability for global use. In conjunction with the IoT interface, the cooling unit can be networked and digitalised	Flexible power distribution solutions, highly adaptable up to 6300 A. Project planning is child's play with the user-friendly Power Engineering software.	Mounting bolts / mounting rails may be installed on a 25 mm pitch pattern pattern in the enclosure depth. For frame attachment, for installation in enclosures without 482.6 mm (19') accommodation. Load capacity up to 100 kg.	The adaptor mounting angles are available for enclosure heights 1600 mm (33 U), 1800 mm (38 U) and 2000 mm (42 U). The 482.6 mm (19') measurement applies when mounting on the frame of 600 mm wide enclosures. Depth-offset installation in 600 mm wide enclosures is supported using punched sections with mounting flanges, 18 x 64 mm.	For mounting between the front and rear mounting levels. To support heavy installed equipment. Side system punchings for mounting accessories and cooling components that expel to the side. Load capacity up to 80 kg static load.
	International approvals (cULus Listed, cULus FTTA, CE and EAC)	–	–	–	–
	–	■	–	■	■
	■	■	–	■	■
	–	■	■	–	–
	■	■	■	–	–
	497	281	1006	1080	1086

Charging infrastructure

System solutions to meet the challenges of a charging infrastructure



Normal charging

- Normal charging refers to the output category below 22 kW, primarily with AC voltage. The charge control may be accommodated in the charging pillar itself or in a backend infrastructure supplying multiple charging pillars simultaneously. Typical application areas include company car parks, supermarkets, hotels or multi-storey car parks where vehicles are parked for long periods and therefore have sufficient time to charge the battery.

Quick charging

- Quick charging refers to an output category of more than 22 kW. Quick charging is primarily achieved with DC voltage. As with normal charging, the charge control may be accommodated in the charging pillar itself or in a backend infrastructure supplying multiple charging pillars. Once again, typical applications include supermarkets, hotels and multi-storey car parks where the electric vehicles are parked for long periods and therefore have time to charge the battery.

High-power charging

- High-power charging is always DC-based and in the output category of above 150 kW. The most common applications are service areas, bus stops and fuel stations where a quick recharge of the vehicle battery is needed. The enclosures must provide protection from harsh environmental conditions as well as access control.



Charging infrastructure



Application		Enclosures		Accessories
System solution		Rittal enclosure solutions provide optimum protection for your components. <ul style="list-style-type: none"> ■ Protection category-tested enclosure technology to IP, IK, RC ■ Accredited in-house laboratory ■ 3-phase surface treatment for maximum corrosion protection ■ Choice of materials depending on the climate and requirement profile: Aluminium, stainless steel, sheet steel ■ EMC protection ■ Static load capacity up to 14,000 N 		
	Construction	Front end/charging pillar	Backend/infrastructure	
Normal charging <ul style="list-style-type: none"> ■ Company car park ■ Supermarket ■ Multi-storey car park ■ Hotel ■ Restaurant 	AC 1 charging point (< 22 kW)	<ul style="list-style-type: none"> ■ Compact enclosures AX, from page 84 ■ Stainless steel (HD), from page 217 		<ul style="list-style-type: none"> ■ Base/plinths, from page 880 ■ Lock systems, from page 933 ■ Rain canopies, from page 958 ■ Interior installation, mounting plates, 482.6 mm (19) frame, bar systems, from page 970 ■ System light, from page 1014 ■ EMC, from page 1028 ■ Cable entry/cable management, from page 1044
	AC n charging points (< 22 kW)	<ul style="list-style-type: none"> ■ Stainless steel (HD), from page 217 	<ul style="list-style-type: none"> ■ Toptec, from page 270 ■ New Basic, from page 268 ■ Baying systems VX25, from page 116 	
Quick charging <ul style="list-style-type: none"> ■ Supermarket ■ Multi-storey car park ■ Hotel ■ Restaurant 	DC 1 charging point	<ul style="list-style-type: none"> ■ Compact enclosures, from page 84 ■ Stainless steel (HD), from page 217 ■ Toptec, from page 270 ■ New Basic, from page 268 ■ Baying systems VX25, from page 116 		
	DC n charging points	<ul style="list-style-type: none"> ■ Compact enclosures AX, from page 84 ■ Toptec, from page 270 ■ New Basic, from page 268 ■ Baying systems VX25, from page 116 	<ul style="list-style-type: none"> ■ Toptec, from page 270 ■ New Basic, from page 268 ■ Baying systems VX25, from page 116 	
High-power charging <ul style="list-style-type: none"> ■ Service area ■ Bus stop 	DC-HPC (> 150 kW)	<ul style="list-style-type: none"> ■ Compact enclosures AX, from page 84 ■ Toptec, from page 270 ■ New Basic, from page 268 ■ Baying systems VX25, from page 116 	<ul style="list-style-type: none"> ■ Toptec, from page 270 ■ New Basic, from page 268 ■ Baying systems VX25, from page 116 	

Other enclosure variants available on request (emobility@rittal.de)



Power distribution

Climate control	Power distribution
<p>A charging centre may require various forms of climate control.</p> <ul style="list-style-type: none"> ■ Fans, cooling units and heaters for temperature control of the built-in equipment. ■ Chillers for water cooling of the charging cable in the HPC sector or components with liquid cooling inside the enclosure ■ Individual design of the required climate control using Therm software 	<p>Rittal offers a modular system for demand-based power distribution.</p> <ul style="list-style-type: none"> ■ Distribution and protection of the power supply focussing on standardisation and availability ■ Power Engineering software is used to plan and design low-voltage switchgear to IEC 61 439 with design verification, from page 446
<ul style="list-style-type: none"> ■ Heaters, from page 530 ■ Passive cooling: TopTherm fan-and-filter units, from page 456 ■ Protective canopies, from page 958 ■ Active: Thermoelectric coolers, from page 474 ■ Cooling units, from page 473 ■ Liquid cooling, from page 509 ■ Outdoor cooling unit, from page 496 ■ Accessories: IoT interface, from page 554 	<ul style="list-style-type: none"> ■ Rated current < 125 A RiLine Compact, from page 282 ■ Rated current < 250 A Mini-PLS, from page 294 ■ Rated current < 1600 A RiLine PLS, from page 299 ■ Rated current < 6300 A VX25 Ri4Power, from page 361

Power distribution software

Configurators/tools/CAD data

Power distribution

The VX25 Power Engineering planning software sets brand new standards when planning low-voltage switchgear. The Web-based tool guides users quickly and efficiently through the planning process in simple, logical steps.



VX25 Power Engineering

Efficient planning of low-voltage switchgear

From plant configuration, to calculation of the copper bars, through to generation of the design verification to IEC 61 439.

Benefits:

- The web-based application ensures that planning data is always up-to-date
- Parts list creation and assembly based on a specific set of rules
- Automatic calculation and documentation of the copper busbars
- Generation of a design verification to IEC 61 439

Note:

- Download free at www.rittal.com/software

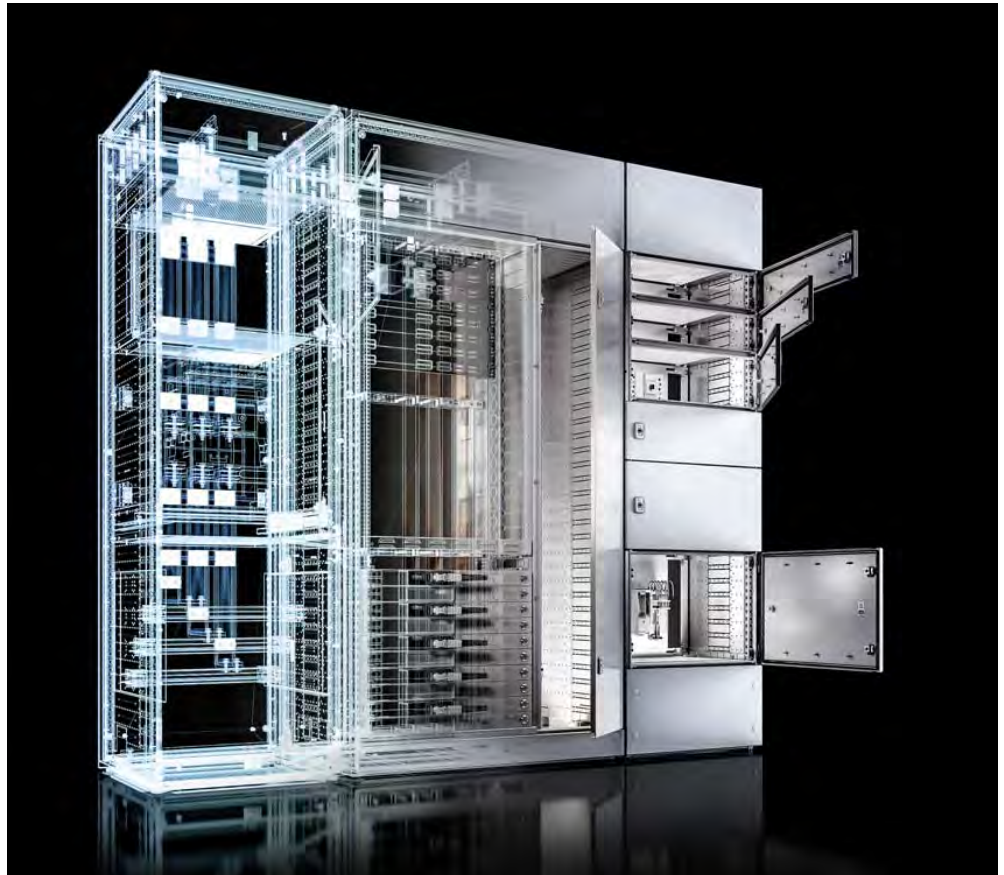

Rittal Automation Systems

High productivity levels and consistent optimisation of all process steps, from page 561

Power distribution

Rittal – The System.

Faster – better – everywhere.



ENCLOSURES

POWER DISTRIBUTION

CLIMATE CONTROL

FRIEDHELM LOH GROUP

CLIMATE CONTROL

Overview of climate control type450

Cooling with ambient air

TopTherm fan-and-filter units454
Roof-mounted fans464
Rack-mounted fans/tangential fans466
Air/air heat exchangers469

Cooling units

Thermoelectric coolers474
Wall-mounted cooling units475
Roof-mounted cooling units498
Blue e+ roof-mounted cooling units / VX25 Blue e+ integration solution504
Modular climate control concept506

Liquid cooling

Air/water heat exchangers510
Liquid Cooling Package518
Chillers519

Enclosure heaters

Enclosure heaters530

Climate control accessories

Filter technology533
Air routing540
Water distribution543
Control/regulation546
Mounting accessories556
Climate control software558

Service

Global availability1134
Services1140

BLUECOMPETENCE

Alliance Member

Partner of the Engineering Industry
Sustainability Initiative



UL listing under category FTTA

Additional approval under the category "environmental-rated accessories for enclosures (CCN: FTTA)" is particularly beneficial for users.

This ensures that the type rating of the application (enclosure protection category) is retained even if the enclosure has a mounting cut-out for installation of a climate control component.

This is a clear benefit which facilitates use in the 508A zone and eliminates potential discussions about reducing the type rating.

IT INFRASTRUCTURE

SOFTWARE & SERVICES



Climate control

Rittal – The System.

Faster – better – everywhere.



Type of climate control	Cooling with ambient air	Cooling units	
	Ambient air cooling units are ideally suited for dissipating heat loads exceptionally cost-effectively. The pre-requisite for this is that the ambient air must be relatively clean and at a temperature below the required enclosure internal temperature.	Cooling units keep the enclosure internal temperature at a constant level, which is independent of the ambient temperature. The air routing meets individual requirements. Two separate circuits prevent the ingress of dust into the enclosure.	
Air throughput, unimpeded airflow m ³ /h	20 – 1069	–	
Specific thermal output W/K	17.5 – 90	–	
Total cooling output W	–	80 – 5800	
Continuous thermal output W	–	–	
Product characteristics	Exceptionally energy-efficient, barely discernible loss of space within and outside of the enclosure, and a high protection category of IP 54 as standard.	The Rittal Blue e+ series is the world's most efficient cooling unit. With heat pipe technology as standard and speed-controlled components, average energy savings of 75% can be achieved.	
From page	453	473	



Climate control

	Cooling with water	Enclosure heaters	Climate control accessories
	Efficient liquid cooling may be used in all situations where a high cooling load is required, such as process and machine cooling or when dissipating heat loss from enclosures via air/water heat exchangers. Liquid cooling allows you to achieve spatial separation between cooling production and process cooling.	Condensation poses a particular risk for control electronics, especially with outdoor siting. A range of output categories ensures that the correct thermal output is always available.	Perfectly coordinated components allow you to customise the climate control to your specific requirements, whether you need targeted air routing, precise control of the equipment or appropriate consumables.
	–	–	–
	–	–	–
	300 – 25000	–	–
	–	10 – 800	–
	Energy savings of up to 70% can be achieved with the Blue e+ generation of chillers. They ensure efficient cooling of liquid media with a high degree of control accuracy thanks to innovative DC inverter technology.	The innovative profile geometry means that heat is distributed evenly inside the enclosure and cold spots are prevented. The tool-free push-in connection technology speeds up the wiring process considerably.	With innovative accessories, the efficiency and reliability of climate control components can be additionally enhanced with monitoring, control and individual air routing.
	509	530	533

Rittal – The System.

Faster – better – everywhere.



Cooling with ambient air

TopTherm fan-and-filter units

Product advantages	454
TopTherm fan-and-filter units..... 20 – 55 m ³ /h.....	456
TopTherm fan-and-filter units..... 105 – 180 m ³ /h.....	457
TopTherm fan-and-filter units..... 230 – 550 m ³ /h.....	457
TopTherm fan-and-filter units..... 700 m ³ /h.....	458
TopTherm fan-and-filter units, EMC	459
TopTherm fan-and-filter units, EMC	460
TopTherm fan-and-filter units, with EC technology.....	461
TopTherm fan-and-filter units, with EC technology.....	462
TopTherm fan-and-filter units, air throughput and protection category	463

Roof-mounted fans

Roof-mounted fans, roof ventilation	464
Roof-mounted fans with EC technology.....	465

Rack-mounted climate control

Rack-mounted fans for 482.6 mm (19').....	466
Vario rack-mounted fans for 482.6 mm (19').....	467
Tangential fans for 482.6 mm (19').....	468

Air/air heat exchangers

TopTherm, wall-mounted with controller.....	469
Roof-mounted 66 W/K	470



Fan-and-filter units and roof-mounted fans

Efficient climate control with ambient air



TopTherm fan-and-filter units

Tool-free assembly

- Straightforward assembly, maintenance and exchange with no need for tools of any kind
- The air flow direction is easily reversed by rotating the fan module
- The electrical connection is individually positionable using a screwless spring terminal; no tools required
- Louvred grille latch mechanism for fast filter mat replacement without tools

Efficient technology

- New diagonal fan technology for greater pressure stability and constant air throughput in its installed state, even with a contaminated filter mat
- Minimum installation depth
- Air flows in a diagonal direction from the fan, for a more even air distribution inside the enclosure
- Extended service life of filter mats means longer maintenance intervals
- Fan with smart, efficient EC technology

Roof-mounted fans

Simple to fit and maintain

- Innovative clamping attachment supports flexible locking optionally from the outside or inside
- Connector terminal for easy electrical connection
- Good accessibility permits fast filter mat changes

High protection category

- IP 55 as standard, thanks to a sophisticated labyrinth system and high-quality foamed-in seal

High efficiency

- At an air throughput of 1,000 m³/h, smart EC fans ensure maximum energy efficiency
- Integral interface for linear speed control and fan monitoring

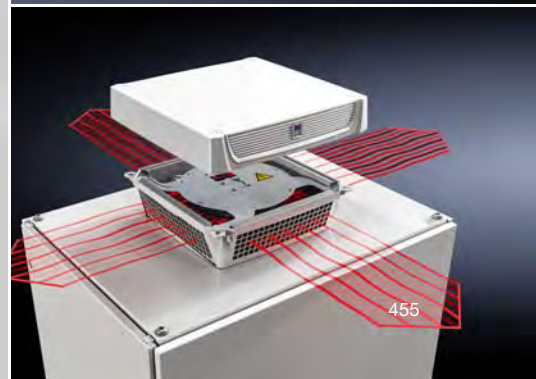
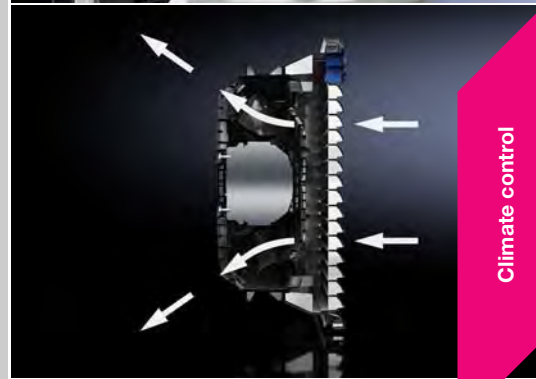

TopTherm fan-and-filter units



Air throughputs incl. outlet filter and protection categories Page 463 **Accessories for climate control** Page 533 **Therm software** Page 558

Fan-and-filter units with diagonal fan technology have superior pressure stability and ensure a more constant air throughput. The diagonal direction of outflow ensures more even heat dissipation from the enclosure.

Colour:

- RAL 7035
- Optionally available in RAL 9005

Supply includes:

- Complete unit ready to install, including filter mat

Note:

- With the fan-and-filter unit 3237.XXX, electrical connection is made via two single wires on the unit. For all other fan-and-filter units, a screwless spring terminal is used.

Approvals:

Available on the Internet

Performance diagrams:

Available on the Internet

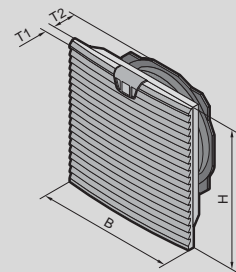

Air throughput 20 – 55 m³/h

Model No.	Packs of	3237.100	3237.110	3237.124	3238.100	3238.110	3238.124	Page
Rated operating voltage V, ~, Hz		230, 1~, 50/60	115, 1~, 50/60	24 (DC)	230, 1~, 50/60	115, 1~, 50/60	24 (DC)	
Air throughput, unimpeded air flow m ³ /h		20 / 25	20 / 25	20	55 / 66	55 / 66	55	
Rated current A		0.065 / 0.052	0.12 / 0.1	0.125	0.12 / 0.11	0.24 / 0.22	0.24	
Power consumption W		11 / 9	11 / 9	3	19 / 18	19 / 18	5.5	
Width (B) mm		116.5	116.5	116.5	148.5	148.5	148.5	
Height (H) mm		116.5	116.5	116.5	148.5	148.5	148.5	
Depth (T1) mm		16	16	16	16	16	16	
Max. installation depth (T2) mm		43	43	43	58.5	58.5	58.5	
Required mounting cut-out (BxH) mm		92 x 92	92 x 92	92 x 92	124 x 124	124 x 124	124 x 124	
Fan		Axial, shaded pole motor	Axial, shaded pole motor	Axial, DC motor	Axial, shaded pole motor	Axial, shaded pole motor	Axial, DC motor	
Operating temperature range		-15 °C...+55 °C	-15 °C...+55 °C	-15 °C...+55 °C	-15 °C...+55 °C	-15 °C...+55 °C	-15 °C...+55 °C	
Storage temperature range		-30 °C...+70 °C	-30 °C...+70 °C	-30 °C...+70 °C	-30 °C...+70 °C	-30 °C...+70 °C	-30 °C...+70 °C	
Noise level dB(A)		38 / 43	38 / 43	38	46 / 49	46 / 49	46	
Service life of fans (L10, 40 °C) h		55000 / 60000	55000 / 60000	70000	68200 / 68200	68200 / 68200	95500	
Weight kg		0.46	0.48	0.3	0.8	0.8	0.54	

Accessories

Accessories		3237.200	3237.200	3237.200	3238.200	3238.200	3238.200	Page
Outlet filter	1 pc(s).	3237.200	3237.200	3237.200	3238.200	3238.200	3238.200	537
Spare filter mat		see page	see page	see page	see page	see page	see page	535
Fine filter mat	5 pc(s).	-	-	-	3238.055	3238.055	3238.055	536
Hose-proof hood	1 pc(s).	3237.080	3237.080	3237.080	3238.080	3238.080	3238.080	538
Blanking cover	2 pc(s).	3237.020	3237.020	3237.020	3238.020	3238.020	3238.020	538
Thermostat	1 pc(s).	3110.000	3110.000	3110.000	3110.000	3110.000	3110.000	547
Hygrostat	1 pc(s).	3118.000	3118.000	3118.000	3118.000	3118.000	3118.000	547
Digital enclosure internal temperature display and thermostat	1 pc(s).	3114.200	3114.200	3114.200	3114.200	3114.200	3114.200	546

TopTherm fan-and-filter units

Air throughput 105 – 180 m³/h

Model No.	Packs of	3239.100	3239.110	3239.124	3240.100	3240.110	3240.124	Page
Rated operating voltage V, ~, Hz		230, 1~, 50/60	115, 1~, 50/60	24 (DC)	230, 1~, 50/60	115, 1~, 50/60	24 (DC)	
Air throughput, unimpeded air flow m ³ /h		105 / 120	105 / 120	105	180 / 160	180 / 160	180	
Rated current A		0.12 / 0.11	0.24 / 0.22	0.23	0.21 / 0.19	0.42 / 0.38	0.43	
Power consumption W		19 / 18	19 / 18	5.5	35 / 34	35 / 34	10	
Width (B) mm		204	204	204	255	255	255	
Height (H) mm		204	204	204	255	255	255	
Depth (T1) mm		24	24	24	25	25	25	
Max. installation depth (T2) mm		90	90	90	107	107	107	
Required mounting cut-out (BxH) mm		177 x 177	177 x 177	177 x 177	224 x 224	224 x 224	224 x 224	
Fan		Axial, shaded pole motor	Axial, shaded pole motor	Axial, DC motor	Diagonal, shaded pole motor	Diagonal, shaded pole motor	Diagonal, DC motor	
Operating temperature range		-15 °C...+55 °C	-15 °C...+55 °C	-15 °C...+55 °C	-30 °C...+55 °C	-30 °C...+55 °C	-30 °C...+55 °C	
Storage temperature range		-30 °C...+70 °C	-30 °C...+70 °C	-30 °C...+70 °C	-30 °C...+70 °C	-30 °C...+70 °C	-30 °C...+70 °C	
Noise level dB(A)		46 / 49	46 / 49	46	51 / 46	51 / 46	51	
Service life of fans (L10, 40 °C) h		68200 / 68200	68200 / 68200	95500	72000 / 76000	72000 / 76000	75000	
Weight kg		1.04	1.04	0.78	2.26	2.08	1.88	

Accessories

Outlet filter	1 pc(s).	3239.200	3239.200	3239.200	3240.200	3240.200	3240.200	537
Spare filter mat		see page	see page	see page	see page	see page	see page	535
Fine filter mat	5 pc(s).	3181.100	3181.100	3181.100	3182.100	3182.100	3182.100	536
Hose-proof hood	1 pc(s).	3239.080	3239.080	3239.080	3240.080	3240.080	3240.080	538
Blanking cover	2 pc(s).	3239.020	3239.020	3239.020	3240.020	3240.020	3240.020	538
Thermostat	1 pc(s).	3110.000	3110.000	3110.000	3110.000	3110.000	3110.000	547
Hygrostat	1 pc(s).	3118.000	3118.000	3118.000	3118.000	3118.000	3118.000	547
Digital enclosure internal temperature display and thermostat	1 pc(s).	3114.200	3114.200	3114.200	3114.200	3114.200	3114.200	546

Air throughput 230 – 550 m³/h

Model No.	Packs of	3241.100	3241.110	3241.124	3243.100	3243.110	Page
Rated operating voltage V, ~, Hz		230, 1~, 50/60	115, 1~, 50/60	24 (DC)	230, 1~, 50/60	115, 1~, 50/60	
Air throughput, unimpeded air flow m ³ /h		230 / 250	230 / 250	230	550 / 600	550 / 600	
Rated current A		0.26 / 0.24	0.52 / 0.48	0.8	0.37 / 0.39	0.78 / 0.8	
Power consumption W		40 / 42	40 / 42	19	70 / 87	75 / 90	
Width (B) mm		255	255	255	323	323	
Height (H) mm		255	255	255	323	323	
Depth (T1) mm		25	25	25	25	25	
Max. installation depth (T2) mm		107	107	107	118.5	118.5	
Required mounting cut-out (BxH) mm		224 x 224	224 x 224	224 x 224	292 x 292	292 x 292	
Fan		Diagonal, shaded pole motor	Diagonal, shaded pole motor	Diagonal, DC motor	Diagonal, 1~ capacitor motor	Diagonal, 1~ capacitor motor	
Operating temperature range		-30 °C...+55 °C	-30 °C...+55 °C	-30 °C...+55 °C	-30 °C...+55 °C	-30 °C...+55 °C	
Storage temperature range		-30 °C...+70 °C	-30 °C...+70 °C	-30 °C...+70 °C	-30 °C...+70 °C	-30 °C...+70 °C	
Noise level dB(A)		54 / 56	54 / 56	54	59 / 61	59 / 61	
Service life of fans (L10, 40 °C) h		61000 / 60000	61000 / 60000	75000	65000 / 61000	61000 / 59000	
Weight kg		2.24	2.26	2.04	3.58	3.58	

Accessories

Outlet filter	1 pc(s).	3240.200	3240.200	3240.200	3243.200	3243.200	537
Spare filter mat		see page	see page	see page	see page	see page	535
Fine filter mat	5 pc(s).	3182.100	3182.100	3182.100	3183.100	3183.100	536
Hose-proof hood	1 pc(s).	3240.080	3240.080	3240.080	3243.080	3243.080	538
Blanking cover	2 pc(s).	3240.020	3240.020	3240.020	3243.020	3243.020	538
Thermostat	1 pc(s).	3110.000	3110.000	3110.000	3110.000	3110.000	547
Hygrostat	1 pc(s).	3118.000	3118.000	3118.000	3118.000	3118.000	547
Digital enclosure internal temperature display and thermostat	1 pc(s).	3114.200	3114.200	3114.200	3114.200	3114.200	546

TopTherm fan-and-filter units

Air throughput 700 m³/h

Model No.	Packs of	3244.100	3244.110	3244.140	Page
Rated operating voltage V, ~, Hz		230, 1~, 50/60	115, 1~, 50/60	400, 3~, 50/60 460, 3~, 60	
Air throughput, unimpeded air flow m ³ /h		700 / 770	700 / 770	700 / 770	
Rated current A		0.43 / 0.6	0.9 / 1.25	0.17 / 0.21	
Power consumption W		95 / 135	100 / 145	93 / 140	
Width (B) mm		323	323	323	
Height (H) mm		323	323	323	
Depth (T1) mm		25	25	25	
Max. installation depth (T2) mm		130.5	130.5	130.5	
Required mounting cut-out (BxH) mm		292 x 292	292 x 292	292 x 292	
Fan		Diagonal, 1~ capacitor motor	Diagonal, 1~ capacitor motor	Diagonal, three-phase motor	
Operating temperature range		-30 °C...+55 °C	-30 °C...+55 °C	-30 °C...+55 °C	
Storage temperature range		-30 °C...+70 °C	-30 °C...+70 °C	-30 °C...+70 °C	
Noise level dB(A)		65 / 66	65 / 66	67 / 70	
Service life of fans (L10, 40 °C) h		66000 / 64000	66000 / 62000	66000 / 62000	
Weight kg		4.3	4.3	4.1	
Accessories					
Outlet filter	1 pc(s).	3243.200	3243.200	3243.200	537
Spare filter mat		see page	see page	see page	535
Fine filter mat	5 pc(s).	3183.100	3183.100	3183.100	536
Hose-proof hood	1 pc(s).	3243.080	3243.080	3243.080	538
Blanking cover	2 pc(s).	3243.020	3243.020	3243.020	538
Thermostat	1 pc(s).	3110.000	3110.000	-	547
Hygrostat	1 pc(s).	3118.000	3118.000	-	547
Digital enclosure internal temperature display and thermostat	1 pc(s).	3114.200	3114.200	-	546

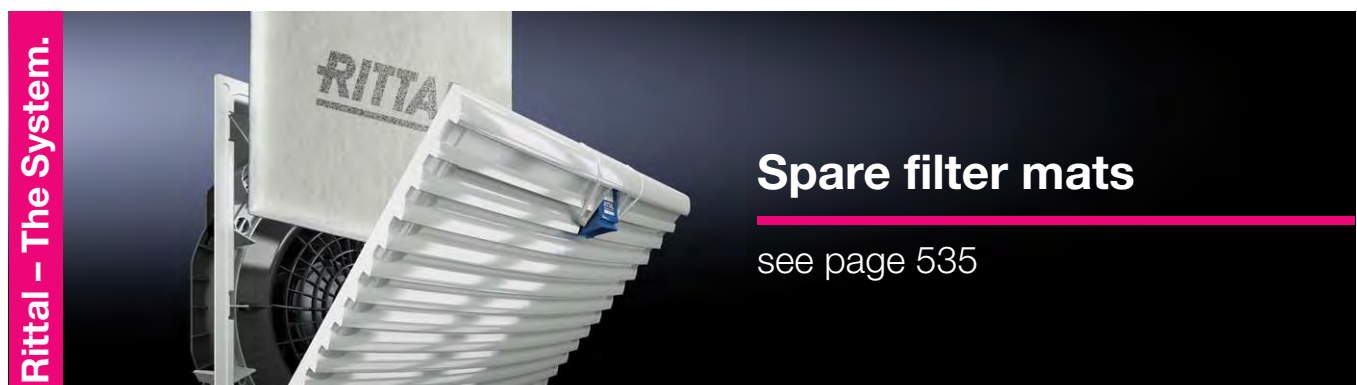

TopTherm fan-and-filter units



Air throughputs incl. outlet filter and protection categories Page 463 **Accessories for climate control** Page 533 **Therm software** Page 558

EMC fan-and-filter units offer a high shielding/attenuation effect and meet requirement category 2 to EN 61587-3.

Colour:

– RAL 7035

Supply includes:

– Complete unit ready to install, including filter mat

Note:

– To improve energy efficiency and extend the service life of the devices, we recommend the use of thermostats or temperature displays

Approvals:

Available on the Internet

Performance diagrams:

Available on the Internet

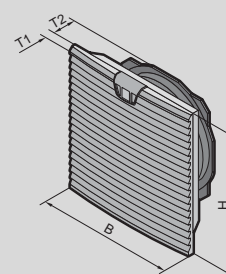

Climate control

Air throughput 20 – 180 m³/h, EMC

Model No.	Packs of	3237.600	3238.600	3239.600	3240.600	Page
Rated operating voltage V, ~, Hz		230, 1~, 50/60	230, 1~, 50/60	230, 1~, 50/60	230, 1~, 50/60	
Air throughput, unimpeded air flow m ³ /h		20 / 25	55 / 66	105 / 120	180 / 160	
Rated current A		0.065 / 0.052	0.12 / 0.11	0.12 / 0.11	0.21 / 0.19	
Power consumption W		11 / 9	19 / 18	19 / 18	35 / 34	
Width (B) mm		116.5	148.5	204	255	
Height (H) mm		116.5	148.5	204	255	
Depth (T1) mm		16	16	24	25	
Max. installation depth (T2) mm		43	58.5	90	107	
Required mounting cut-out (BxH) mm		92 x 92	124 x 124	177 x 177	224 x 224	
Fan		Axial, shaded pole motor	Axial, shaded pole motor	Axial, shaded pole motor	Diagonal, shaded pole motor	
Operating temperature range		-15 °C...+55 °C	-15 °C...+55 °C	-15 °C...+55 °C	-30 °C...+55 °C	
Storage temperature range		-30 °C...+70 °C	-30 °C...+70 °C	-30 °C...+70 °C	-30 °C...+70 °C	
Noise level dB(A)		38 / 43	46 / 49	46 / 49	51 / 46	
Service life of fans (L10, 40 °C) h		55000 / 60000	68200 / 68200	68200 / 68200	72000 / 76000	
Weight kg		0.49	2.0	1.2	2.12	

Accessories

Accessories	Packs of	3237.060	3238.060	3239.060	3240.060	Page
Outlet filter	1 pc(s).	3237.060	3238.060	3239.060	3240.060	537
Spare filter mat	5 pc(s).	3237.066	3238.066	3239.066	3240.066	535
Fine filter mat	5 pc(s).	–	3238.055	3181.100	3182.100	536
Hose-proof hood	1 pc(s).	3237.080	3238.080	3239.080	3240.080	538
Speed control	1 pc(s).	3120.200	3120.200	3120.200	3120.200	549
EC speed control – Control unit for EC fan		–	–	–	–	
EC speed control – Sensor for speed control		–	–	–	–	
Thermostat	1 pc(s).	3110.000	3110.000	3110.000	3110.000	547
Hygrostat	1 pc(s).	3118.000	3118.000	3118.000	3118.000	547
Digital enclosure internal temperature display and thermostat	1 pc(s).	3114.200	3114.200	3114.200	3114.200	546

TopTherm fan-and-filter units

Air throughput 230 – 900 m³/h, EMC

Model No.	Packs of	3241.600	3243.600	3244.600	3245.600	Page
Rated operating voltage V, ~, Hz		230, 1~, 50/60	230, 1~, 50/60	230, 1~, 50/60	200 - 240, 1~, 50/60	
Air throughput, unimpeded air flow m ³ /h		230 / 250	550 / 600	700 / 770	900	
Rated current A		0.26 / 0.24	0.37 / 0.39	0.43 / 0.6	1.33 / 1.33	
Power consumption W		40 / 42	70 / 87	95 / 135	165 / 165	
Width (B) mm		255	323	323	323	
Height (H) mm		255	323	323	323	
Depth (T1) mm		25	25	25	25	
Max. installation depth (T2) mm		107	118.5	130.5	130.5	
Required mounting cut-out (BxH) mm		224 x 224	292 x 292	292 x 292	292 x 292	
Fan		Diagonal, shaded pole motor	Diagonal, 1~ capacitor motor	Diagonal, 1~ capacitor motor	Diagonal, EC motor	
Operating temperature range		-30 °C...+55 °C	-30 °C...+55 °C	-30 °C...+55 °C	-25 °C...+55 °C	
Storage temperature range		-30 °C...+70 °C	-30 °C...+70 °C	-30 °C...+70 °C	-25 °C...+70 °C	
Noise level dB(A)		54 / 56	59 / 61	65 / 66	72	
Service life of fans (L10, 40 °C) h		61000 / 60000	65000 / 61000	66000 / 64000	59000	
Weight kg		2.12	3.56	4.28	3.5	
Accessories						
Outlet filter	1 pc(s).	3240.060	3243.060	3243.060	3243.060	537
Spare filter mat	5 pc(s).	3240.066	3243.066	3243.066	3243.066	535
Fine filter mat	5 pc(s).	3182.100	3183.100	3183.100	3183.100	536
Hose-proof hood	1 pc(s).	3240.080	3243.080	3243.080	3245.080	538
Speed control	1 pc(s).	3120.200	3120.200	3120.200	-	549
EC speed control – Control unit for EC fan	1 pc(s).	-	-	-	3235.440	548
EC speed control – Sensor for speed control	1 pc(s).	-	-	-	3235.450	548
Thermostat	1 pc(s).	3110.000	3110.000	3110.000	3110.000	547
Hygrostat	1 pc(s).	3118.000	3118.000	3118.000	3118.000	547
Digital enclosure internal temperature display and thermostat	1 pc(s).	3114.200	3114.200	3114.200	3114.200	546



EC speed control

see page 548

TopTherm fan-and-filter units



Air throughputs incl. outlet filter and protection categories Page 463 Accessories for climate control Page 533 Therm software Page 558

Energy-efficient version of the TopTherm fan-and-filter units with diagonal fan technology. Fans 3240.500 to 3245.510 may be controlled and monitored. The fan may be activated via the control interface with tacho signal output integrated as standard, and monitoring of the fan speed and function is supported.

Colour:

- RAL 7035

Supply includes:

- Complete unit ready to install, including filter mat

Note:

- For even more efficient operation or for monitoring the fan-and-filter units, we recommend the use of an EC speed control for EC fan-and-filter units

Approvals:

Available on the Internet

Performance diagrams:

Available on the Internet

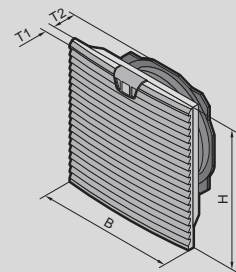

Climate control

Air throughput 55 – 230 m³/h, with EC technology

Model No.	Packs of	3238.500	3239.500	3240.500	3241.500	Page
Control interface		-	-	■	■	
Rated operating voltage V, ~, Hz		200 - 240, 1~, 50/60	200 - 240, 1~, 50/60	200 - 240, 1~, 50/60	200 - 240, 1~, 50/60	
Air throughput, unimpeded air flow m ³ /h		55 / 55	105 / 105	180 / 180	230 / 230	
Rated current A		0.045 / 0.045	0.045 / 0.045	0.12 / 0.12	0.17 / 0.17	
Power consumption W		6.1 / 6.1	6.1 / 6.1	11 / 11	16 / 16	
Width (B) mm		148.5	204	255	255	
Height (H) mm		148.5	204	255	255	
Depth (T1) mm		16	24	25	25	
Max. installation depth (T2) mm		58.5	90	107	107	
Required mounting cut-out (BxH) mm		124 x 124	177 x 177	224 x 224	224 x 224	
Fan		Diagonal, EC motor	Diagonal, EC motor	Diagonal, EC motor	Diagonal, EC motor	
Operating temperature range		-20 °C...+55 °C	-20 °C...+55 °C	-25 °C...+55 °C	-25 °C...+55 °C	
Storage temperature range		-30 °C...+70 °C	-30 °C...+70 °C	-25 °C...+70 °C	-25 °C...+70 °C	
Noise level dB(A)		49 / 49	53 / 53	47 / 47	52 / 52	
Service life of fans (L10, 40 °C) h		62500	62500	71000	64000	
Weight kg		0.62	0.91	2.01	1.98	

Accessories

Outlet filter	1 pc(s).	3238.200	3239.200	3240.200	3240.200	537
Spare filter mat		see page	see page	see page	see page	535
Fine filter mat	5 pc(s).	3238.055	3181.100	3182.100	3182.100	536
Hose-proof hood	1 pc(s).	3238.080	3239.080	3240.080	3240.080	538
Blanking cover	2 pc(s).	3238.020	3239.020	3240.020	3240.020	538
EC speed control – Control unit for EC fan	1 pc(s).	-	-	3235.440	3235.440	548
EC speed control – Sensor for speed control	1 pc(s).	-	-	3235.450	3235.450	548
Thermostat	1 pc(s).	3110.000	3110.000	3110.000	3110.000	547
Hygrostat	1 pc(s).	3118.000	3118.000	3118.000	3118.000	547
Digital enclosure internal temperature display and thermostat	1 pc(s).	3114.200	3114.200	3114.200	3114.200	546

TopTherm fan-and-filter units

Air throughput 550 – 900 m³/h, with EC technology

Model No.	Packs of	3243.500	3244.500	3245.500	3245.510	Page
Control interface		■	■	■	■	
Rated operating voltage V, ~, Hz		200 - 240, 1~, 50/60	200 - 240, 1~, 50/60	200 - 240, 1~, 50/60	100 - 130, 1~, 50/60	
Air throughput, unimpeded air flow m³/h		550 / 550	700 / 700	900 / 900	900 / 900	
Rated current A		0.5 / 0.5	0.7 / 0.7	1.33 / 1.33	2.1 / 2.1	
Power consumption W		51 / 51	80 / 80	165 / 165	165 / 165	
Width (B) mm		323	323	323	323	
Height (H) mm		323	323	323	323	
Depth (T1) mm		25	25	25	25	
Max. installation depth (T2) mm		118.5	130.5	130.5	130.5	
Required mounting cut-out (BxH) mm		292 x 292	292 x 292	292 x 292	292 x 292	
Fan		Diagonal, EC motor	Diagonal, EC motor	Diagonal, EC motor	Diagonal, EC motor	
Operating temperature range		-25 °C...+55 °C	-25 °C...+55 °C	-25 °C...+55 °C	-25 °C...+55 °C	
Storage temperature range		-25 °C...+70 °C	-25 °C...+70 °C	-25 °C...+70 °C	-25 °C...+70 °C	
Noise level dB(A)		63 / 63	64 / 64	72 / 72	72 / 72	
Service life of fans (L10, 40 °C) h		65000	67000	59000	59000	
Weight kg		2.92	2.7	3.46	3.76	

Accessories

Outlet filter	1 pc(s).	3243.200	3243.200	3243.200	3243.200	537
Spare filter mat		see page	see page	see page	see page	535
Fine filter mat	5 pc(s).	3183.100	3183.100	3183.100	3183.100	536
Hose-proof hood	1 pc(s).	3243.080	3243.080	3245.080	3245.080	538
Blanking cover	2 pc(s).	3243.020	3243.020	3243.020	3243.020	538
EC speed control – Control unit for EC fan	1 pc(s).	3235.440	3235.440	3235.440	3235.440	548
EC speed control – Sensor for speed control	1 pc(s).	3235.450	3235.450	3235.450	3235.450	548
Thermostat	1 pc(s).	3110.000	3110.000	3110.000	3110.000	547
Hygrostat	1 pc(s).	3118.000	3118.000	3118.000	3118.000	547
Digital enclosure internal temperature display and thermostat	1 pc(s).	3114.200	3114.200	3114.200	3114.200	546

Rittal – The System.



Therm software

see page 558

TopTherm fan-and-filter units

Air throughput and protection category

TopTherm fan-and-filter units

Model No.	Air throughput m ³ /h at 50/60 Hz				Protection category IP to IEC 60 529/NEMA protection category			
	Unimpeded air flow	With outlet filter including filter mat			Standard filter	Standard filter and additional micro-filter mat	Standard filter and hose-proof hood	
3237.100	20/25	1 x 3237.200			IP 54/ Type 12	-	IP 56/ Type 3, 3R	
3237.110		15/18	-	-				
3237.124		20						
3238.100	55/66	1 x 3238.200	2 x 3238.200			IP 54/ Type 12	IP 54/ Type 12	IP 56/ Type 3, 3R Type 4, 4X
3238.110		43/50	46/56					
3238.124	55	1 x 3238.200	2 x 3238.200					
3239.100	105/120	1 x 3239.200	2 x 3239.200	1 x 3240.200				
3239.110		87/100	93/108	98/111				
3239.124	105	1 x 3239.200	2 x 3239.200	1 x 3240.200				
3240.100	180/160	1 x 3240.200	2 x 3240.200	1 x 3243.200				
3240.110		138/121	165/140	165/140				
3240.124	180	1 x 3240.200	2 x 3240.200	1 x 3243.200				
3241.100	230/250	1 x 3240.200	2 x 3240.200	1 x 3243.200				
3241.110		183/205	203/220	203/230				
3241.124	230	1 x 3240.200	2 x 3240.200	1 x 3243.200				
3243.100	550/600	1 x 3243.200	2 x 3243.200					
3243.110		465/510	508/548					
3244.100	700/770	1 x 3243.200	2 x 3243.200					
3244.110		544/587	630/690					
3244.140								

TopTherm fan-and-filter units, EMC

Model No.	Air throughput m ³ /h at 50/60 Hz				Protection category IP to IEC 60 529/NEMA protection category				
	Unimpeded air flow	With EMC outlet filter including EMC filter mat			Standard filter	Standard filter and additional micro-filter mat	Standard filter and hose-proof hood		
3237.600	20/25	1 x 3237.060			IP 54/ Type 12	-	IP 56/ Type 3, 3R		
3238.600		15/18							
3238.600	55/66	1 x 3238.060	2 x 3238.060			IP 54/ Type 12	IP 54/ Type 12	IP 56/ Type 3, 3R Type 4, 4X	
3239.600		43/50	46/56						
3239.600	105/120	1 x 3239.060	2 x 3239.060	1 x 3240.060					
3240.600		87/100	93/108	98/111					
3240.600	180/160	1 x 3240.060	2 x 3240.060	1 x 3243.060					
3241.600		138/121	165/140	165/140					
3241.600	230/250	1 x 3240.060	2 x 3240.060	1 x 3243.060					
3243.600		183/205	203/220	203/230					
3243.600	550/600	1 x 3243.060	2 x 3243.060						
3244.600		465/510	508/548						
3244.600	700/770	1 x 3243.060	2 x 3243.060						
3245.600		544/587	630/690						
3245.600	900	1 x 3243.060	2 x 3243.060				IP 51		IP 52

TopTherm fan-and-filter units with EC technology

Model No.	Air throughput m ³ /h at 50/60 Hz				Protection category IP to IEC 60 529/NEMA protection category				
	Unimpeded air flow	With outlet filter including filter mat			Standard filter	Standard filter and additional micro-filter mat	Standard filter and hose-proof hood		
3238.500	55	1 x 3238.200	2 x 3238.200		IP 54/ Type 12	IP 54/ Type 12	IP 56/ Type 3, 3R Type 4, 4X		
3239.500		43	46						
3239.500	105	1 x 3239.200	2 x 3239.200	1 x 3240.200					
3240.500		87	93	98					
3240.500	180	1 x 3240.200	2 x 3240.200	1 x 3243.200					
3241.500		138	165	165					
3241.500	230	1 x 3240.200	2 x 3240.200	1 x 3243.200					
3243.500		183	203	203					
3243.500	550	1 x 3243.200	2 x 3243.200						
3244.500		465	508						
3244.500	700	1 x 3243.200	2 x 3243.200						
3245.500		544	630						
3245.500	900	1 x 3243.200	2 x 3243.200			IP 51		IP 52	IP 56/ Type 1, 12 Type 3, 3R
3245.510		680	820						
3245.510	900	1 x 3243.200	2 x 3243.200						

Roof-mounted fan, roof vent



Accessories for climate control Page 533 Therm software Page 558

Roof-mounted fan with a high protection category and flexible installation from the inside or outside.

Colour:

– RAL 7035

Protection category IP to IEC 60 529:

- IP 21 without filter mat
- IP 55 including filter mat

Protection category NEMA:

– NEMA 12

Supply includes:

- Complete unit ready to install, including filter mat

Note:

- To improve energy efficiency and extend the service life of the devices, we recommend the use of thermostats or temperature displays

Approvals:

Available on the Internet

Performance diagrams:

Available on the Internet

Air throughput, unimpeded air flow 500 – 965 m³/h

Model No.	Packs of	3138.000	3139.100	3139.110	3140.100	3140.110	3140.140	Page
Rated operating voltage V, ~, Hz		–	220 - 240, 1~, 50/60	115, 1~, 60	220 - 240, 1~, 50/60	115, 1~, 60	380 - 415, 3~, 50/60 400 - 480, 3~, 60	
Air throughput, unimpeded air flow (without filter mats) m³/h		–	500 / 525	525	873 / 965	965	863 / 942	
Air throughput, unimpeded air flow (with filter mats) m³/h		–	417 / 446	446	725 / 759	759	700 / 749	
Rated current A		–	0.23 / 0.27	0.56	0.43 / 0.56	1.2	0.17 / 0.2	
Power consumption W		–	51 / 62	65	99 / 130	138	98 / 130	
Width mm		400	400	400	400	400	400	
Height mm		133	133	133	133	133	133	
Depth mm		400	400	400	400	400	400	
Max. installation depth mm		27.5	34.6	34.6	34.6	34.6	34.6	
Required mounting cut-out mm		258 x 258	258 x 258	258 x 258	258 x 258	258 x 258	258 x 258	
Fan		without fan motor	Radial, capacitor motor	Radial, capacitor motor	Radial, capacitor motor	Radial, capacitor motor	Radial, rotary current motor	
Operating temperature range		-20 °C...+55 °C	-20 °C...+55 °C	-20 °C...+55 °C	-20 °C...+55 °C	-20 °C...+55 °C	-20 °C...+55 °C	
Storage temperature range		-40 °C...+70 °C	-40 °C...+70 °C	-40 °C...+70 °C	-40 °C...+70 °C	-40 °C...+70 °C	-40 °C...+70 °C	
Service life of fans (L10, 40 °C) h		–	69000 / 67600	69400 / 68000	62800 / 65800	67800 / 66400	63500 / 61500	
Weight kg		3.2	5.2	5.2	6.0	6.0	6.0	
Accessories								
Outlet filter	1 pc(s).	3243.200	3243.200	3243.200	3243.200	3243.200	3243.200	537
Spare filter mat	12 pc(s).	3174.100	3174.100	3174.100	3174.100	3174.100	3174.100	535
Speed control	1 pc(s).	–	3120.200	3120.200	3120.200	3120.200	–	549
Thermostat	1 pc(s).	–	3110.000	3110.000	3110.000	3110.000	3110.000	547
Hygrostat	1 pc(s).	–	3118.000	3118.000	3118.000	3118.000	3118.000	547
Digital enclosure internal temperature display and thermostat	1 pc(s).	–	3114.200	3114.200	3114.200	3114.200	3114.200	546



Accessories for climate control Page 533 **Therm software** Page 558

Energy-efficient and powerful design of the roof-mounted fans. The fan may be activated via the control interface with tachometer signal output integrated as standard, and monitoring of the fan speed and function is supported.

Colour:

- RAL 7035

Protection category IP to IEC 60 529:

- IP 21 without filter mat
- IP 55 including filter mat

Protection category NEMA:

- NEMA 12

Supply includes:

- Complete unit ready to install, including filter mat

Note:

- For even more efficient operation or for monitoring the fans, we recommend the use of the EC speed controls

Approvals:

Available on the Internet

Performance diagrams:

Available on the Internet

Air throughput, unimpeded air flow 1069 m³/h, with EC technology

Model No.	Packs of	3140.500	3140.510	Page
Control interface		■	■	
Rated operating voltage V, ~, Hz		220 - 240, 1~, 50/60	115, 1~, 60	
Air throughput, unimpeded air flow (without filter mats) m³/h		1069 / 1069	1069	
Air throughput, unimpeded air flow (with filter mats) m³/h		841 / 841	841	
Rated current A		1 / 1	1.51	
Power consumption W		129 / 129	112	
Width mm		400	400	
Height mm		133	133	
Depth mm		400	400	
Max. installation depth mm		34.6	34.6	
Required mounting cut-out mm		258 x 258	258 x 258	
Fan		Radial, EC motor	Radial, EC motor	
Operating temperature range		-20 °C...+55 °C	-20 °C...+55 °C	
Storage temperature range		-40 °C...+70 °C	-40 °C...+70 °C	
Service life of fans (L10, 40 °C) h		84000 / 84000	82000 / 82000	
Weight kg		5.6	5.6	
Accessories				
Outlet filter	1 pc(s).	3243.200	3243.200	537
Spare filter mat	12 pc(s).	3174.100	3174.100	535
EC speed control – Control unit for EC fan	1 pc(s).	3235.440	3235.440	548
EC speed control – Sensor for speed control	1 pc(s).	3235.450	3235.450	548
Thermostat	1 pc(s).	3110.000	3110.000	547
Hygrostat	1 pc(s).	3118.000	3118.000	547
Digital enclosure internal temperature display and thermostat	1 pc(s).	3114.200	3114.200	546

Rack-mounted fans for 482.6 mm (19")



Accessories for climate control Page 533

Rack-mounted fan for direct installation in the 482.6 mm (19") level. Installation allows air to circulate permanently inside the enclosure, thus preventing the formation of hot spots.

Colour:

- RAL 7035

Supply includes:

- Fully wired unit ready for connection
- Terminal strip and assembly parts

Approvals:

Available on the Internet

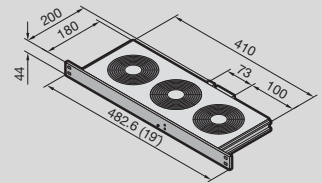

Air throughput, unimpeded air flow 320 – 480 m³/h

Model No.	Packs of	3340.230	3341.115	3341.230	3342.024	3342.230	3342.500	Page
With monitoring		-	-	-	-	-	■	
Rated operating voltage V, ~, Hz		230, 1~, 50/60	115, 1~, 50/60	230, 1~, 50/60	24 (DC)	230, 1~, 50/60	115 - 230, 1~, 50/60 24 (DC)	
Air throughput, unimpeded air flow m ³ /h		320	480	480	480	480	480	
No. of fans		2	3	3	3	3	3	
Distance between axes mm		85	85	85	105	105	105	
Rated current A		0.24 / 0.22	0.69 / 0.69	0.36 / 0.33	0.74	0.36 / 0.33	0.85	
Width mm		482.6	482.6	482.6	482.6	482.6	482.6	
Height mm		44	44	44	44	44	44	
Depth mm		200	200	200	200	200	200	
Operating temperature range		-10 °C...+55 °C	-10 °C...+55 °C	-10 °C...+55 °C	-10 °C...+55 °C	-10 °C...+55 °C	-10 °C...+55 °C	
Noise level dB(A)		51	52	51	51	51	51	
Weight kg		2.24	2.0	2.74	1.86	2.78	2.0	

Accessories

Digital enclosure internal temperature display and thermostat	1 pc(s).	3114.200	3114.200	3114.200	3114.200	3114.200	3114.200	546
Thermostat	1 pc(s).	3110.000	3110.000	3110.000	3110.000	3110.000	3110.000	547
Speed control	1 pc(s).	3120.200	3120.200	3120.200	-	3120.200	-	549

Vario rack-mounted fans for 482.6 mm (19")



Accessories for climate control Page 533

Rack-mounted fan for direct installation in the 482.6 mm (19") level. Installation allows air to circulate permanently inside the enclosure, thus preventing the formation of hot spots.

Benefits:

- Guide frame ensures easy maintenance and replacement of the fans

Colour:

- RAL 7035

Supply includes:

- Fully wired unit ready for connection
- Terminal strip and assembly parts

Approvals:

Available on the Internet

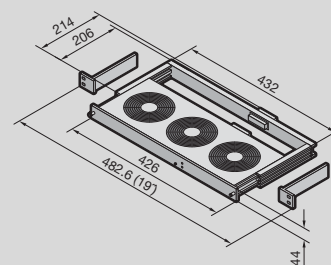

Climate control

Air throughput, unimpeded air flow 320 – 480 m³/h

Model No.	Packs of	3350.230	3351.230	3352.230	3352.500	Page
With monitoring		–	–	–	■	
Rated operating voltage V, ~, Hz		230, 1~, 50/60	230, 1~, 50/60	230, 1~, 50/60	115 - 230, 1~, 50/60 24 (DC)	
Air throughput, unimpeded air flow m³/h		320	480	480	480	
No. of fans		2	3	3	3	
Distance between axes mm		85	85	105	105	
Rated current A		0.24 / 0.22	0.36 / 0.33	0.36 / 0.33	0.85 / 0.85	
Width mm		482.6	482.6	482.6	482.6	
Height mm		44	44	44	44	
Depth mm		200	200	200	200	
Operating temperature range		-10 °C...+55 °C	-10 °C...+55 °C	-10 °C...+55 °C	-10 °C...+55 °C	
Noise level dB(A)		51	51	51	51	
Weight kg		2.0	2.7	2.78	2.04	
Also required						
Guide frame	1 pc(s).	3355.100	3355.100	3355.100	3357.100	557
Accessories						
Digital enclosure internal temperature display and thermostat	1 pc(s).	3114.200	3114.200	3114.200	3114.200	546
Thermostat	1 pc(s).	3110.000	3110.000	3110.000	3110.000	547
Speed control	1 pc(s).	3120.200	3120.200	3120.200	–	549

Tangential fan for 482.6 mm (19")

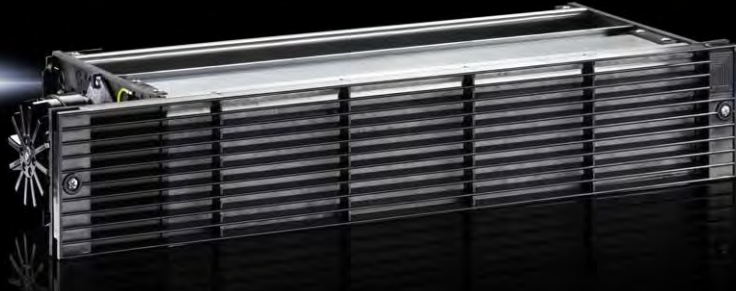

Accessories for climate control Page 533

Centrifugal fans for direct installation in the 482.6 mm (19") level provide a wide column of air plus favourable noise characteristics to set them apart from other fans.

Colour:

- RAL 9005

Supply includes:

- Fully wired unit ready for connection
- Filter mat

Approvals:

Available on the Internet

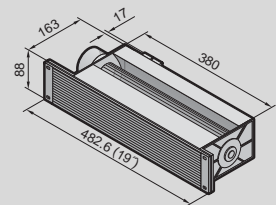

Air throughput, unimpeded air flow 320 m³/h

Model No.	Packs of	3144.000	Page
Rated operating voltage V, ~, Hz		230, 1~, 50/60	
Air throughput, unimpeded air flow m³/h		320	
Rated current A		0.16	
Power consumption W		37	
Width mm		482.6	
Height mm		88	
Depth mm		163	
Operating temperature range		-10 °C...+55 °C	
Noise level dB(A)		52	
Speed rpm		2245	
Maximum static pressure difference Pa		65 - 70	
Weight kg		2.02	
Accessories			
Digital enclosure internal temperature display and thermostat	1 pc(s).	3114.200	546
Thermostat	1 pc(s).	3110.000	547
Filter mat	5 pc(s).	3177.000	533
Front outlet grille 2 U	1 pc(s).	3176.000	539
Speed control	1 pc(s).	3120.200	549

TopTherm air/air heat exchangers



Accessories for climate control Page 533 Therm software Page 558

Air/air heat exchangers are particularly well-suited to aggressive ambient conditions, because the internal and external air circuits are completely separate from one another.

Temperature control:

- Electronic control with digital display (factory setting +35 °C)

Colour:

- RAL 7035

Protection category IP to IEC 60 529:

- Internal circuit IP 54
- External circuit IP 34

Supply includes:

- Complete unit ready for connection
- Plug-in terminal strip
- Floating fault signal contact in case of overtemperature
- Drilling template
- Assembly parts

Approvals:

Available on the Internet

Performance diagrams:

Available on the Internet

Climate control

Specific thermal output 17.5 – 90 W/K, wall-mounted with controller

Model No.	Packs of	3126.100	3127.100	3128.100	3129.100	3130.100	Page
Rated operating voltage V, ~, Hz		230, 1~, 50/60	230, 1~, 50/60	230, 1~, 50/60	230, 1~, 50/60	230, 1~, 50/60	
Specific thermal output W/K		17.5	30	45	60	90	
Rated current A		0.22 / 0.26	0.56 / 0.68	0.6 / 0.8	0.75 / 0.8	1.35 / 1.8	
Rated power input W		50 / 60	120 / 150	140 / 180	170 / 180	300 / 400	
Width mm		280	400	400	400	400	
Height mm		550	950	950	950	1580	
Depth mm		150	205	205	225	215	
Operating temperature range		-5 °C...+55 °C	-5 °C...+55 °C	-5 °C...+55 °C	-5 °C...+55 °C	-5 °C...+55 °C	
Weight kg		10.0	18.0	19.0	21.0	34.0	
Accessories							
Filter mat	3 pc(s).	3286.300	3286.400	3286.400	3286.400	3286.400	533
Metal filter	1 pc(s).	3286.310	3286.410	3286.410	3286.410	3286.410	534

Air/air heat exchanger



Accessories for climate control Page 533 **Therm software** Page 558

Air/air heat exchangers are particularly well-suited to aggressive ambient conditions, because the internal and external air circuits are completely separate from one another.

Colour:

- Cover: RAL 7035
- Enclosure: RAL 7016

Protection category IP to IEC 60 529:

- Internal circuit IP 54
- External circuit IP 34

Supply includes:

- Complete unit ready for connection
- The fans are connected via two 3-wire connection cables, with wire end ferrules
- Drilling template
- Assembly parts

Note:

- For precise temperature control inside the enclosure, we recommend the enclosure internal thermostat, the digital enclosure internal temperature display and thermostat or the speed control.

Specific thermal output 66 W/K, roof-mounted

Model No.	Packs of	3248.000	Page
Rated operating voltage V, ~, Hz		230, 1~, 50/60	
Specific thermal output W/K		66	
No. of fans		2	
Max. rated current per fan A		0.32 / 0.4	
Rated power input W		70 / 90	
Width mm		595	
Height mm		362	
Depth mm		440	
Operating temperature range		-5 °C...+55 °C	
Type of electrical connection		Connection cable	
Weight kg		25.0	
Accessories			
Digital enclosure internal temperature display and thermostat	1 pc(s).	3114.200	546
Thermostat	1 pc(s).	3110.000	547
Hygrostat	1 pc(s).	3118.000	547
Speed control	1 pc(s).	3120.200	549

Roof-mounted fans

Simple installation and a high protection category,
from page 464



Rittal – The System.

Faster – better – everywhere.



Cooling units

Thermoelectric coolers

Thermoelectric coolers	80 W	474
------------------------------	------------	-----

Wall-mounted cooling units

TopTherm, horizontal format	300 W	475
TopTherm	300 W	476
TopTherm Blue e	500 W	478
TopTherm Blue e	750 W	478
TopTherm Blue e	1000 W	479
TopTherm Blue e	1500 W	480
TopTherm Blue e	2000 W	481
TopTherm Blue e	2500 W	482
TopTherm Blue e, slimline	1500 W	483
Product advantages		484
Blue e+	1600 W	487
Blue e+	2000 – 5800 W	489
TopTherm Blue e, NEMA 4X	500 – 1500 W	490
TopTherm Blue e, NEMA 4X	2000 – 2500 W	491
Product advantages		492
TopTherm Blue e, UL Type 3R/4	500 – 2500 W	494
Product advantages		496
Outdoor cooling unit	1500 W	497

Roof-mounted cooling units

TopTherm Blue e	500 W	498
TopTherm Blue e	750 W	499
TopTherm Blue e	1000 W	499
TopTherm Blue e	1100 – 1500 W	500
TopTherm Blue e	2000 W	500
TopTherm Blue e	3000 – 4000 W	501
Product advantages		502
Blue e+	1300 W	504

Integration solution

Product advantages		502
VX25 Blue e+	1300 W	505

Modular climate control concept

Cooling module Blue e	1500 – 2500 W	506
Section doors for installing cooling modules		507



The perfect symbiosis of the VX25 baying enclosure system and Blue e+ cooling unit

- **Integrated all-in-one system**
The Blue e+ cooling unit is already integrated in the VX25 enclosure
- **Plug & play**
Cooling unit, door limit switches and cabling are installed ready to connect
- **State-of-the-art design**
No cooling unit built onto the enclosure



Thermoelectric coolers



Accessories for climate control Page 533 Therm software Page 558

Powerful thermoelectric cooling units in a lightweight design for the climate control of command panels and small enclosures.

Material:

– Device: Aluminium, anodised

Colour:

– Cover: RAL 7015

Protection category IP to IEC 60 529:

– External circuit IP 34
– Internal circuit IP 54

Supply includes:

- Thermoelectric climate control unit
- Fully wired ready for connection (plug-in terminal strip)
- Mounting accessories
- Filter mat
- USB cable A/B
- Drilling template

Performance diagrams:

Available on the Internet

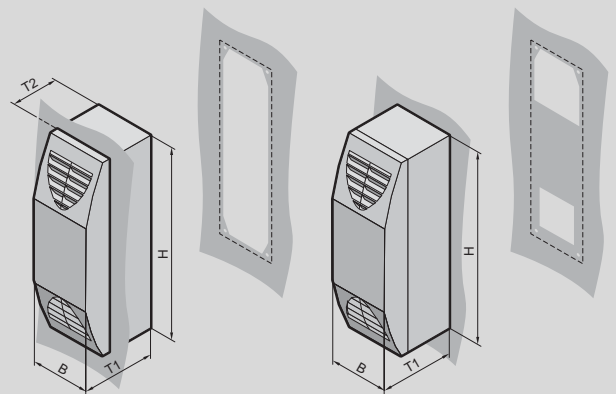

Total cooling output 80/100 W

Model No.	Packs of	3201.200	3201.300	Page
Rated operating voltage V, ~, Hz		100 - 240, 1~, 50/60	24 (DC)	
Total cooling output L35 L35 W		80 / 80	80	
Total cooling output L35 L30 W		100 / 100	100	
Thermal output W		80	80	
Width (B) mm		125	125	
Height (H) mm		400	400	
Depth (T1) mm		155	155	
Installation depth (T2) mm		100	100	
Operating temperature range		-30 °C...+55 °C	-30 °C...+60 °C	
Setting range, cooling		+5 °C...+55 °C	+5 °C...+55 °C	
Setting range, heating		-10 °C...+20 °C	-10 °C...+20 °C	
Refrigeration factor/COP		0.8	0.9	
Power pack integrated		■	–	
Weight kg		3.3	2.6	
Accessories				
Spare filter mat	5 pc(s).	3201.050	3201.050	535
Condensate hose	1 pc(s).	3301.606	3301.606	544

TopTherm wall-mounted cooling units, horizontal format



Accessories for climate control Page 533 **Therm software** Page 558

Compact wall-mounted cooling units in horizontal format, with nano-coated condenser.

Temperature control:

- Basic controller (factory setting +35 °C)

Protection category IP to IEC 60 529:

- External circuit IP 34
- Internal circuit IP 54

Supply includes:

- Nano-coated condenser
- Fully wired ready for connection (plug-in terminal strip)
- Drilling template
- Assembly parts

Approvals:

Available on the Internet

Performance diagrams:

Available on the Internet

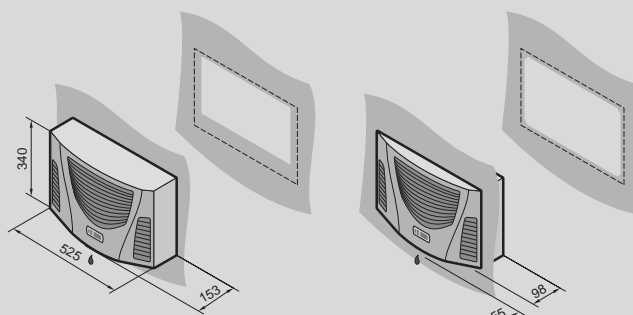

Climate control

Output class 300 W

Model No.		Packs of	3302.300	3302.310	Page
Material	Sheet steel		■	■	
Colour	RAL 7035		■	■	
Total cooling output 50 Hz L35 L35 to DIN EN 14511 kW			0.36	-	
Total cooling output 50/60 Hz L35 L35 kW			0.36 / 0.38	0.38	
Total cooling output 50/60 Hz L35 L50 kW			0.21 / 0.22	0.23	
Rated operating voltage V, ~, Hz			230, 1~, 50/60	115, 1~, 60	
Width mm			525	525	
Height mm			340	340	
Depth mm			153	153	
Rated current max. A			1.6 / 1.7	4	
Start-up current A			4.3 / 5.3	12	
Power consumption P _{el} 50/60 Hz L35 L35 kW			0.27 / 0.29	0.32	
Operating temperature range			+10 °C...+55 °C	+10 °C...+55 °C	
Setting range			+30 °C...+55 °C	+30 °C...+55 °C	
Energy efficiency ratio (EER) 50/60 Hz L35 L35			1.34 / 1.3	1.18	
Refrigerant g			R134a, 100	R134a, 100	
Weight kg			13.0	13.0	
Accessories					
Filter mat		3 pc(s).	3286.110	3286.110	533
Metal filter		1 pc(s).	3286.120	3286.120	534
Door-operated switch		1 pc(s).	4127.010	4127.010	1024
Condensate hose		1 pc(s).	3301.608	3301.608	544
Electric condensate evaporator		1 pc(s).	3301.500	3301.500	543

TopTherm wall-mounted cooling units



Accessories for climate control Page 533 **Therm software** Page 558

Compact wall-mounted cooling units, with nano-coated condenser.

Temperature control:

- Basic controller (factory setting +35 °C)

Protection category IP to IEC 60 529:

- External circuit IP 34
- Internal circuit IP 54

Supply includes:

- Nano-coated condenser
- Fully wired ready for connection (plug-in terminal strip)
- Drilling template
- Assembly parts

Approvals:

Available on the Internet

Performance diagrams:

Available on the Internet

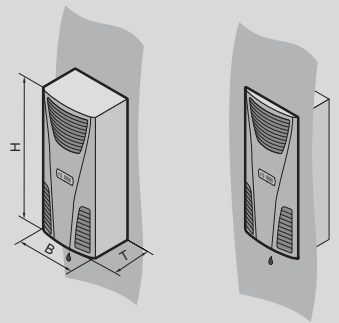

Output class 300 W

Model No.		Packs of	3302.100	3302.110	3302.200	Page
Material	Sheet steel		■	■	-	
	Stainless steel 1.4301 (AISI 304)		-	-	■	
Colour	RAL 7035		■	■	-	
	RAL 9007		-	-	■	
Total cooling output 50 Hz L35 L35 to DIN EN 14511 kW			0.36	-	0.36	
Total cooling output 50/60 Hz L35 L35 kW			0.36 / 0.38	0.38	0.36 / 0.38	
Total cooling output 50/60 Hz L35 L50 kW			0.21 / 0.23	0.23	0.21 / 0.23	
Rated operating voltage V, ~, Hz			230, 1~, 50/60	115, 1~, 60	230, 1~, 50/60	
Width (B) mm			280	280	280	
Height (H) mm			550	550	550	
Depth (T) mm			140	140	140	
Rated current max. A			1.6 / 1.7	3.3	1.6 / 1.7	
Start-up current A			3 / 3.4	8	3 / 3.4	
Power consumption P _{el} 50/60 Hz L35 L35 kW			0.27 / 0.28	0.32	0.27 / 0.28	
Operating temperature range			+10 °C...+55 °C	+10 °C...+55 °C	+10 °C...+55 °C	
Setting range			+30 °C...+55 °C	+30 °C...+55 °C	+30 °C...+55 °C	
Energy efficiency ratio (EER) 50/60 Hz L35 L35			1.3 / 1.32	1.18	1.3 / 1.32	
Refrigerant g			R134a, 100	R134a, 100	R134a, 100	
Weight kg			13.0	13.0	13.0	

Accessories

Filter mat	3 pc(s).	3286.300	3286.300	3286.300	533
Metal filter	1 pc(s).	3286.310	3286.310	3286.310	534
Door-operated switch	1 pc(s).	4127.010	4127.010	4127.010	1024
Condensate hose	1 pc(s).	3301.610	3301.610	3301.610	544
Electric condensate evaporator	1 pc(s).	3301.500	3301.500	3301.500	543

TopTherm wall-mounted cooling units Blue e



Accessories for climate control Page 533 **Therm software** Page 558 **RiDiag software** Page 559

Energy-efficient Blue e wall-mounted cooling units with integral e-Comfort controller and RiNano coating on the condenser as standard.

Benefits:

- May be linked to the IoT interface via the Blue e IoT adaptor

Temperature control:

- e-Comfort controller (factory setting +35 °C)

Protection category IP to IEC 60 529:

- External circuit IP 34
- Internal circuit IP 54

Supply includes:

- Nano-coated condenser
- Fully wired ready for connection (plug-in terminal strip)
- Drilling template
- Assembly parts

Note:

- The technical specifications for the wall-mounted cooling unit 3361.540 apply with an external transformer connected.

Approvals:

Available on the Internet

Performance diagrams:

Available on the Internet

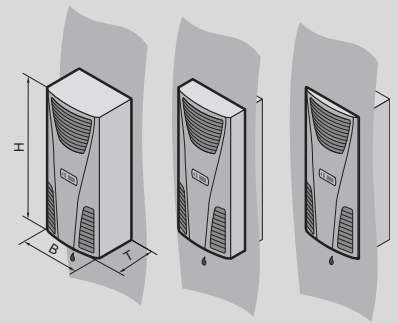

Climate control

TopTherm wall-mounted cooling units Blue e

Output class 500 W

Model No.		Packs of	3303.500	3303.510	3303.600	Page
Material	Sheet steel		■	■	–	
	Stainless steel 1.4301 (AISI 304)		–	–	■	
Colour	RAL 7035		■	■	–	
	RAL 9007		–	–	■	
Total cooling output 50 Hz L35 L35 to DIN EN 14511 kW			0.55	–	0.55	
Total cooling output 50/60 Hz L35 L35 kW			0.55 / 0.66	0.66	0.55 / 0.66	
Total cooling output 50/60 Hz L35 L50 kW			0.33 / 0.4	0.4	0.33 / 0.4	
Rated operating voltage V, ~, Hz			230, 1~, 50/60	115, 1~, 60	230, 1~, 50/60	
Width (B) mm			280	280	280	
Height (H) mm			550	550	550	
Depth (T) mm			210	210	210	
Rated current max. A			2.6 / 2.6	5.7	2.6 / 2.6	
Start-up current A			5.1 / 6.4	11.5	5.1 / 6.4	
Toroidal transformer (external) Ø x D			–	–	–	
Power consumption P _{el} 50/60 Hz L35 L35 kW			0.39 / 0.41	0.5	0.39 / 0.41	
Operating temperature range			+10 °C...+55 °C	+10 °C...+55 °C	+10 °C...+55 °C	
Operating temperature (max.) 60 Hz			–	–	–	
Setting range			+20 °C...+55 °C	+20 °C...+55 °C	+20 °C...+55 °C	
Energy efficiency ratio (EER) 50/60 Hz L35 L35			1.4 / 1.21	1.31	1.4	
Refrigerant g			R134a, 170	R134a, 170	R134a, 170	
Weight kg			17.0	17.0	17.0	

Accessories						
IoT interface	1 pc(s).	3124.300	3124.300	3124.300	3124.300	554
Blue e IoT adaptor	1 pc(s).	3124.310	3124.310	3124.310	3124.310	555
Door-operated switch	1 pc(s).	4127.010	4127.010	4127.010	4127.010	1024
Filter mat	3 pc(s).	3286.300	3286.300	3286.300	3286.300	533
Metal filter	1 pc(s).	3286.310	3286.310	3286.310	3286.310	534
Master/slave cable	1 pc(s).	3124.100	3124.100	3124.100	3124.100	550
Electric condensate evaporator	1 pc(s).	3301.500	3301.500	3301.500	3301.500	543
Condensate hose	1 pc(s).	3301.610	3301.610	3301.610	3301.610	544
RI Diag	1 pc(s).	3159.100	3159.100	3159.100	3159.100	559

Output class 750 W

Model No.		Packs of	3361.500	3361.510	3361.540	3361.600	Page
Material	Sheet steel		■	■	■	–	
	Stainless steel 1.4301 (AISI 304)		–	–	–	■	
Colour	RAL 7035		■	■	■	–	
	RAL 9007		–	–	–	■	
Total cooling output 50 Hz L35 L35 to DIN EN 14511 kW			0.85	–	0.85	0.85	
Total cooling output 50/60 Hz L35 L35 kW			0.85 / 0.89	0.89	0.85 / 0.89	0.85 / 0.89	
Total cooling output 50/60 Hz L35 L50 kW			0.67 / 0.67	0.67	0.67 / 0.67	0.67 / 0.67	
Rated operating voltage V, ~, Hz			230, 1~, 50/60	115, 1~, 60	400, 2~, 50/60	230, 1~, 50/60	
Width (B) mm			280	280	280	280	
Height (H) mm			550	550	550	550	
Depth (T) mm			280	280	280	280	
Rated current max. A			2.7 / 2.7	5.3	1.2 / 1.4	2.7 / 2.7	
Start-up current A			6 / 9.6	12	3.1 / 3.3	6 / 9.6	
Toroidal transformer (external) Ø x D mm			–	–	126 x 65	–	
Power consumption P _{el} 50/60 Hz L35 L35 kW			0.4 / 0.43	0.55	0.4 / 0.43	0.4 / 0.43	
Operating temperature range			+10 °C...+55 °C	+10 °C...+52 °C	+10 °C...+55 °C	+10 °C...+55 °C	
Operating temperature (max.) 60 Hz			+53 °C	+52 °C	+53 °C	+53 °C	
Setting range			+20 °C...+55 °C	+20 °C...+55 °C	+20 °C...+55 °C	+20 °C...+55 °C	
Energy efficiency ratio (EER) 50/60 Hz L35 L35			2.08 / 2.03	1.59	2.08 / 2.03	2.08 / 2.03	
Refrigerant g			R134a, 280	R134a, 260	R134a, 280	R134a, 280	
Weight kg			22.0	22.0	22.0	22.0	

Accessories						
IoT interface	1 pc(s).	3124.300	3124.300	3124.300	3124.300	554
Blue e IoT adaptor	1 pc(s).	3124.310	3124.310	3124.310	3124.310	555
Door-operated switch	1 pc(s).	4127.010	4127.010	4127.010	4127.010	1024
Filter mat	3 pc(s).	3286.300	3286.300	3286.300	3286.300	533
Metal filter	1 pc(s).	3286.310	3286.310	3286.310	3286.310	534
Master/slave cable	1 pc(s).	3124.100	3124.100	3124.100	3124.100	550
Electric condensate evaporator	1 pc(s).	3301.500	3301.500	3301.500	3301.500	543
Condensate hose	1 pc(s).	3301.610	3301.610	3301.610	3301.610	544
RI Diag	1 pc(s).	3159.100	3159.100	3159.100	3159.100	559

TopTherm wall-mounted cooling units Blue e



Accessories for climate control Page 533 Therm software Page 558 RiDiag software Page 559

Energy-efficient Blue e wall-mounted cooling units with integral e-Comfort controller, RiNano coating on the condenser and electrical condensate evaporation as standard.

Benefits:

- May be linked to the IoT interface via the Blue e IoT adaptor

Temperature control:

- e-Comfort controller (factory setting +35 °C)

Protection category IP to IEC 60 529:

- External circuit IP 34
- Internal circuit IP 54

Supply includes:

- Nano-coated condenser
- Integral electric condensate evaporation
- Fully wired ready for connection (plug-in terminal strip)
- Drilling template
- Assembly parts

Approvals:

Available on the Internet

Performance diagrams:

Available on the Internet

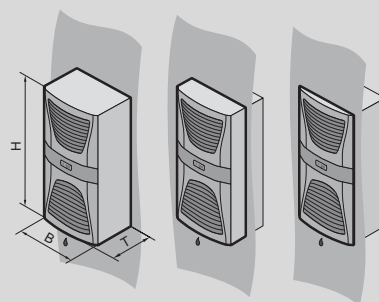

Climate control

Output class 1000 W

Model No.	Packs of	3304.500	3304.510	3304.540	3304.600	3304.640	Page
Material	Sheet steel	■	■	■	–	–	
	Stainless steel 1.4301 (AISI 304)	–	–	–	■	■	
Colour	RAL 7035	■	■	■	–	–	
	RAL 9007	–	–	–	■	■	
Total cooling output 50 Hz L35 L35 to DIN EN 14511 kW		1.1	1.1	1.1	1.1	1.1	
Total cooling output 50/60 Hz L35 L35 kW		1.1 / 1.25	1.1 / 1.25	1.1 / 1.25	1.1 / 1.25	1.1 / 1.26	
Total cooling output 50/60 Hz L35 L50 kW		0.91 / 0.9	0.91 / 0.9	0.98 / 0.9	0.91 / 0.9	0.98 / 0.9	
Rated operating voltage V, ~, Hz		230, 1~, 50/60	115, 1~, 50/60	400, 3~, 50 460, 3~, 60	230, 1~, 50/60	400, 3~, 50 460, 3~, 60	
Width (B) mm		400	400	400	400	400	
Height (H) mm		950	950	950	950	950	
Depth (T) mm		260	260	260	260	260	
Rated current max. A		3.9 / 4.3	8 / 8.8	2.2 / 2.1	3.9 / 4.3	2.2 / 2.1	
Start-up current A		12 / 14	26 / 28	11.5 / 12.7	12 / 14	11.5 / 12.7	
Power consumption P _{el} 50/60 Hz L35 L35 kW		0.64 / 0.68	0.64 / 0.68	0.64 / 0.79	0.6 / 0.68	0.64 / 0.79	
Operating temperature range		+10 °C...+55 °C	+10 °C...+55 °C	+10 °C...+55 °C	+10 °C...+55 °C	+10 °C...+55 °C	
Setting range		+20 °C...+55 °C	+20 °C...+55 °C	+20 °C...+55 °C	+20 °C...+55 °C	+20 °C...+55 °C	
Energy efficiency ratio (EER) 50/60 Hz L35 L35		1.83 / 1.84	1.83 / 1.84	1.72 / 1.58	1.83 / 1.84	1.72 / 1.59	
Refrigerant g		R134a, 325	R134a, 325	R134a, 325	R134a, 325	R134a, 325	
Weight kg		39.0	44.0	40.0	39.0	40.0	

Accessories

Accessories	Quantity	3304.500	3304.510	3304.540	3304.600	3304.640	Page
IoT interface	1 pc(s).	3124.300	3124.300	3124.300	3124.300	3124.300	554
Blue e IoT adaptor	1 pc(s).	3124.310	3124.310	3124.310	3124.310	3124.310	555
Door-operated switch	1 pc(s).	4127.010	4127.010	4127.010	4127.010	4127.010	1024
Filter mat	3 pc(s).	3286.400	3286.400	3286.400	3286.400	3286.400	533
Metal filter	1 pc(s).	3286.410	3286.410	3286.410	3286.410	3286.410	534
Master/slave cable	1 pc(s).	3124.100	3124.100	3124.100	3124.100	3124.100	550
Air diverter	1 pc(s).	3213.310	3213.310	3213.310	3213.310	3213.310	542
Condensate hose	1 pc(s).	3301.612	3301.612	3301.612	3301.612	3301.612	544
RiDiag	1 pc(s).	3159.100	3159.100	3159.100	3159.100	3159.100	559

TopTherm wall-mounted cooling units Blue e

Output class 1500 W

Model No.	Packs of	3305.500	3305.510	3305.540	Page
Material	Sheet steel	■	■	■	
Colour	RAL 7035	■	■	■	
Total cooling output 50 Hz L35 L35 to DIN EN 14511 kW		1.6	1.6	1.6	
Total cooling output 50/60 Hz L35 L35 kW		1.6 / 1.76	1.6 / 1.76	1.6 / 1.61	
Total cooling output 50/60 Hz L35 L50 kW		1.25 / 1.37	1.25 / 1.37	1.33 / 1.35	
Rated operating voltage V, ~, Hz		230, 1~, 50/60	115, 1~, 50/60	400, 3~, 50 460, 3~, 60	
Width (B) mm		400	400	400	
Height (H) mm		950	950	950	
Depth (T) mm		260	260	260	
Rated current max. A		5.5 / 5.8	11.5 / 12.5	2.5 / 2.8	
Start-up current A		12 / 14	26 / 28	12.2 / 11.3	
Power consumption P _{el} 50/60 Hz L35 L35 kW		0.87 / 0.98	0.87 / 0.98	0.9 / 1.08	
Operating temperature range		+10 °C...+55 °C	+10 °C...+55 °C	+10 °C...+55 °C	
Setting range		+20 °C...+55 °C	+20 °C...+55 °C	+20 °C...+55 °C	
Energy efficiency ratio (EER) 50/60 Hz L35 L35		1.83 / 1.79	1.83 / 1.79	1.83 / 1.49	
Refrigerant g		R134a, 500	R134a, 500	R134a, 500	
Weight kg		41.0	46.0	42.0	
Accessories					
IoT interface	1 pc(s).	3124.300	3124.300	3124.300	554
Blue e IoT adaptor	1 pc(s).	3124.310	3124.310	3124.310	555
Door-operated switch	1 pc(s).	4127.010	4127.010	4127.010	1024
Filter mat	3 pc(s).	3286.400	3286.400	3286.400	533
Metal filter	1 pc(s).	3286.410	3286.410	3286.410	534
Master/slave cable	1 pc(s).	3124.100	3124.100	3124.100	550
Air diverter	1 pc(s).	3213.310	3213.310	3213.310	542
Condensate hose	1 pc(s).	3301.612	3301.612	3301.612	544
RiDiag	1 pc(s).	3159.100	3159.100	3159.100	559

Rittal – The System.



Rittal Configuration System

see page 272

TopTherm wall-mounted cooling units Blue e



Accessories for climate control Page 533 Therm software Page 558 RiDiag software Page 559

Energy-efficient Blue e wall-mounted cooling units with integral e-Comfort controller, RiNano coating on the condenser and electrical condensate evaporation as standard.

Benefits:

- May be linked to the IoT interface via the Blue e IoT adaptor

Temperature control:

- e-Comfort controller (factory setting +35 °C)

Protection category IP to IEC 60 529:

- External circuit IP 34
- Internal circuit IP 54

Supply includes:

- Nano-coated condenser
- Integral electric condensate evaporation
- Fully wired ready for connection (plug-in terminal strip)
- Drilling template
- Assembly parts

Approvals:

Available on the Internet

Performance diagrams:

Available on the Internet

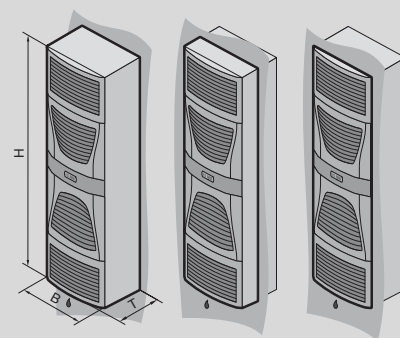

Climate control

Output class 2000 W

Model No.	Packs of	3328.500	3328.540	Page
Material	Sheet steel	■	■	
Colour	RAL 7035	■	■	
Total cooling output 50 Hz L35 L35 to DIN EN 14511 kW		2.2	2.2	
Total cooling output 50/60 Hz L35 L35 kW		2.2 / 2.56	2.2 / 2.55	
Total cooling output 50/60 Hz L35 L50 kW		1.82 / 1.95	1.65 / 1.89	
Rated operating voltage V, ~, Hz		230, 1~, 50/60	400, 3~, 50 460, 3~, 60	
Width (B) mm		400	400	
Height (H) mm		1580	1580	
Depth (T) mm		295	295	
Rated current max. A		6.1 / 6.6	2.8 / 3.3	
Start-up current A		20 / 22	6.8 / 7.8	
Power consumption P _{el} 50/60 Hz L35 L35 kW		0.91 / 1.03	0.92 / 1.15	
Operating temperature range		+10 °C...+55 °C	+10 °C...+55 °C	
Setting range		+20 °C...+55 °C	+20 °C...+55 °C	
Energy efficiency ratio (EER) 50/60 Hz L35 L35		2.4 / 2.47	2.4 / 2.22	
Refrigerant g		R134a, 950	R134a, 950	
Weight kg		66.0	67.0	
Accessories				
IoT interface	1 pc(s).	3124.300	3124.300	554
Blue e IoT adaptor	1 pc(s).	3124.310	3124.310	555
Door-operated switch	1 pc(s).	4127.010	4127.010	1024
Filter mat	3 pc(s).	3286.400	3286.400	533
Metal filter	1 pc(s).	3286.410	3286.410	534
Master/slave cable	1 pc(s).	3124.100	3124.100	550
Air diverter	1 pc(s).	3213.320	3213.320	542
Condensate hose	1 pc(s).	3301.612	3301.612	544
RiDiag	1 pc(s).	3159.100	3159.100	559
Eyebolts	4 pc(s).	4568.000	4568.000	964

TopTherm wall-mounted cooling units Blue e

Output class 2500 W

Model No.	Packs of	3329.500	3329.540	Page
Material	Sheet steel	■	■	
Colour	RAL 7035	■	■	
Total cooling output 50 Hz L35 L35 to DIN EN 14511 kW		2.55	2.55	
Total cooling output 50/60 Hz L35 L35 kW		2.55 / 2.71	2.55 / 2.75	
Total cooling output 50/60 Hz L35 L50 kW		1.8 / 1.8	1.95 / 2	
Rated operating voltage V, ~, Hz		230, 1~, 50/60	400, 3~, 50 460, 3~, 60	
Width (B) mm		400	400	
Height (H) mm		1580	1580	
Depth (T) mm		295	295	
Rated current max. A		7.9 / 9.3	3.3 / 3.4	
Start-up current A		25 / 22	6.8 / 7.6	
Power consumption P _{el} 50/60 Hz L35 L35 kW		1.21 / 1.35	1.19 / 1.39	
Operating temperature range		+10 °C...+55 °C	+10 °C...+55 °C	
Setting range		+20 °C...+55 °C	+20 °C...+55 °C	
Energy efficiency ratio (EER) 50/60 Hz L35 L35		2.11 / 2.01	2.11 / 1.97	
Refrigerant g		R134a, 950	R134a, 950	
Weight kg		69.0	70.0	
Accessories				
IoT interface	1 pc(s).	3124.300	3124.300	554
Blue e IoT adaptor	1 pc(s).	3124.310	3124.310	555
Door-operated switch	1 pc(s).	4127.010	4127.010	1024
Filter mat	3 pc(s).	3286.400	3286.400	533
Metal filter	1 pc(s).	3286.410	3286.410	534
Master/slave cable	1 pc(s).	3124.100	3124.100	550
Air diverter	1 pc(s).	3213.320	3213.320	542
Condensate hose	1 pc(s).	3301.612	3301.612	544
RiDiag	1 pc(s).	3159.100	3159.100	559
Eyebolts	4 pc(s).	4568.000	4568.000	964

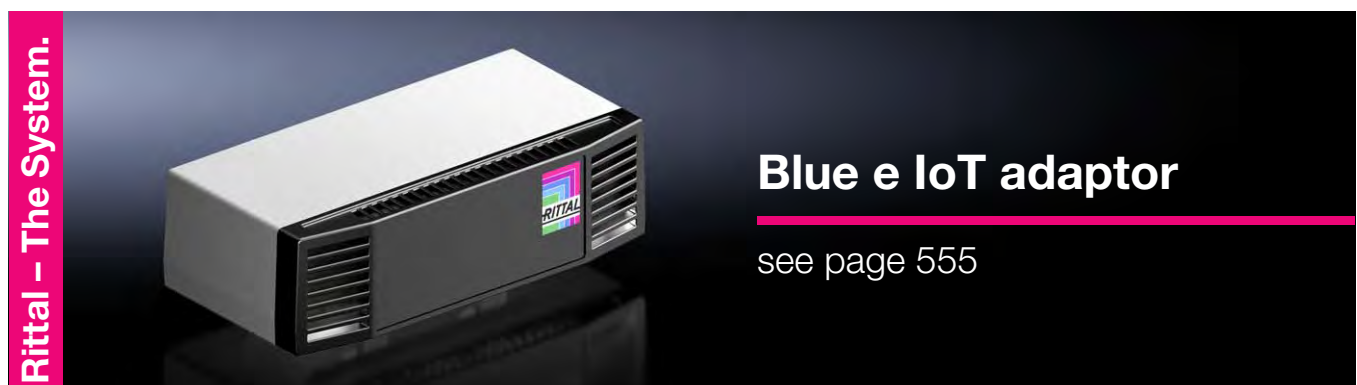

Rittal – The System.

Blue e IoT adaptor

see page 555

TopTherm wall-mounted cooling units Blue e, slimline



Accessories for climate control Page 533 Therm software Page 558 RiDiag software Page 559

Energy-efficient Blue e wall-mounted cooling units with e-Comfort controller integrated as standard, RiNano coating on the condenser and electrical condensate evaporation. Slimline design.

Benefits:

- May be linked to the IoT interface via the Blue e IoT adaptor

Temperature control:

- e-Comfort controller (factory setting +35 °C)

Protection category IP to IEC 60 529:

- External circuit IP 34
- Internal circuit IP 54

Supply includes:

- Nano-coated condenser
- Integral electric condensate evaporation
- Fully wired ready for connection (plug-in terminal strip)
- Drilling template
- Assembly parts for internal mounting

Note:

- For external mounting of the cooling unit, trim frame 3377.000 including assembly parts may be fitted. This gives the cooling unit a closed front appearance.

Approvals:

Available on the Internet

Performance diagrams:

Available on the Internet

Output class 1500 W

Model No.	Packs of	3366.500	3366.540	Page
Material	Sheet steel	■	■	
Colour	RAL 7035	■	■	
Total cooling output 50 Hz L35 L35 to DIN EN 14511 kW		1.6	1.6	
Total cooling output 50/60 Hz L35 L35 kW		1.6 / 1.6	1.6 / 1.6	
Total cooling output 50/60 Hz L35 L50 kW		1.15 / 1.2	1.08 / 1.18	
Rated operating voltage V, ~, Hz		230, 1~, 50/60	400, 3~, 50 460, 3~, 60	
Width mm		435	435	
Height mm		1590	1590	
Depth mm		205	205	
Rated current max. A		6.7 / 6.9	2.7 / 2.9	
Start-up current A		22 / 24	8 / 8.8	
Power consumption P _{el} 50/60 Hz L35 L35 kW		0.84 / 0.97	0.9 / 1.05	
Operating temperature range		+10 °C...+55 °C	+10 °C...+55 °C	
Setting range		+20 °C...+55 °C	+20 °C...+55 °C	
Energy efficiency ratio (EER) 50/60 Hz L35 L35		1.9 / 1.65	1.9 / 1.52	
Refrigerant g		R134a, 700	R134a, 700	
Weight kg		45.0	46.0	
Accessories				
IoT interface	1 pc(s).	3124.300	3124.300	554
Blue e IoT adaptor	1 pc(s).	3124.310	3124.310	555
Door-operated switch	1 pc(s).	4127.010	4127.010	1024
Filter mat	3 pc(s).	3286.400	3286.400	533
Metal filter	1 pc(s).	3286.410	3286.410	534
Master/slave cable	1 pc(s).	3124.100	3124.100	550
Trim frame	1 pc(s).	3377.000	3377.000	556
Condensate hose	1 pc(s).	3301.612	3301.612	544
RiDiag	1 pc(s).	3159.100	3159.100	559

Wall-mounted cooling units Blue e+

The world's most efficient range of cooling units.



Incredibly efficient

- Average 75% energy savings with innovative hybrid technology
- Active cooling circuit with speed-regulated components for demand-based cooling
- Integral heat pipe for passive cooling dissipates heat from the enclosure as soon as the ambient temperature falls below the setpoint

Intelligent networking

- In conjunction with the IoT interface, all Blue e+ cooling units can now be networked and digitalised

The benefits for you:

- Continuous monitoring of temperature levels
- Avoidance of downtime costs and consequential damage
- Automatic notification of any cooling unit malfunctions
- Asset Management: Localisation and organisation of cooling units
- Remote access: Device parameters can be configured remotely

Easier to operate

- Fast unit analysis using RiDiag III software via USB port
- Fast parameterisation, data reading and plain-text system messages via the intelligent, multilingual, industry-grade display
- Contactless on-site information sharing and fast, direct analysis via the NFC interface with the Blue e+ app

Maximum flexibility

- One device for all voltages and networks, suitable for worldwide use thanks to inverter technology:
 - 110 to 240 V, 1~, 50/60 Hz
 - 380 to 480 V, 3~, 50/60 Hz
- International approvals and certifications
- Available in sheet steel or stainless steel
- One version for external mounting, partial internal mounting and full internal mounting with identical mounting cut-out



Climate control



Wall-mounted cooling units Blue e+



Accessories for climate control Page 533 Therm software Page 558 Blue e+ app Page 559 IoT interface Page 554

Benefits:

- Average 75% energy savings thanks to speed-regulated components and heat pipe technology
- Suitable for international use due to a unique multi-voltage capability
- Longer service life of the components inside the enclosure and the cooling unit due to component-friendly cooling
- Intuitive operation due to touch display and intelligent interfaces

Temperature control:

- e+ controller (factory setting +35 °C)

Protection category IP to IEC 60 529:

- Internal circuit IP 55

Supply includes:

- Nano-coated condenser
- Integral electric condensate evaporation
- Assembly parts
- Fully wired ready for connection (plug-in terminal strip)

Optional:

- For remote monitoring and networking of cooling units and chillers in the Blue e+ generation, please use the IoT interface (Model No. 3124.300). Increase machine availability and process reliability with remote monitoring of device data, statuses and system messages.

Note:

- Please observe the mounting instructions.
- Firmware can be updated using the RiDiag III software (3159.300)

Approvals:

Available on the Internet

Performance diagrams:

Available on the Internet

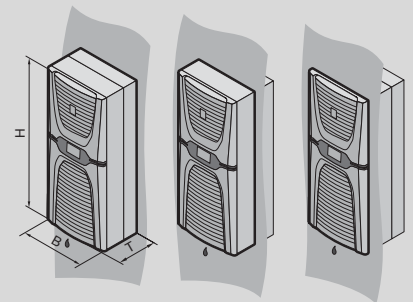

Wall-mounted cooling units Blue e+

Output class 1600 W

Model No.	Packs of	3185.530	3185.830	Page
Material	Sheet steel	-	■	
	Stainless steel 1.4301 (AISI 304)	■	-	
Colour	RAL 7035	-	■	
	RAL 9007	■	-	
Total cooling output 50 Hz L35 L35 to DIN EN 14511 kW		1.6	1.6	
Total cooling output 50/60 Hz L35 L35 kW		1.6 / 1.6	1.6 / 1.6	
Total cooling output 50/60 Hz L35 L50 kW		1.2 / 1.2	1.2 / 1.2	
Rated operating voltage V, -, Hz		110 - 240, 1-, 50/60 380 - 480, 3-, 50/60	110 - 240, 1-, 50/60 380 - 480, 3-, 50/60	
Width (B) mm		400	400	
Height (H) mm		950	950	
Depth (T) mm		310	310	
Rated power input kW		0.62	0.62	
Power consumption P _{el} 50/60 Hz L35 L35 kW		0.54 / 0.54	0.54 / 0.54	
Operating temperature range		-20 °C...+60 °C	-20 °C...+60 °C	
Setting range		+20 °C...+50 °C	+20 °C...+50 °C	
Energy efficiency ratio (EER) 50/60 Hz L35 L35		3.1 / 3.1	3.1 / 3.1	
Seasonal energy efficiency ratio (SEER) 50/60 Hz		6.4	6.4	
Refrigerant g		R134a, 750	R134a, 750	
Weight kg		36.3	37.1	

Accessories				
IoT interface	1 pc(s).	3124.300	3124.300	554
Door-operated switch	1 pc(s).	4127.010	4127.010	1024
Filter mat	3 pc(s).	3285.800	3285.800	533
Metal filter	1 pc(s).	3285.810	3285.810	534
Temperature sensor	1 pc(s).	3124.400	3124.400	549
Condensate hose	1 pc(s).	3301.612	3301.612	544
Eyebolts	4 pc(s).	4568.000	4568.000	964
RiDiag	1 pc(s).	3159.300	3159.300	559

Rittal – The System.



IoT Interface

see page 554

Wall-mounted cooling units Blue e+



Accessories for climate control Page 533 Therm software Page 558 Blue e+ app Page 559 IoT interface Page 554

Benefits:

- Average 75% energy savings thanks to speed-regulated components and heat pipe technology
- Suitable for international use due to a unique multi-voltage capability
- Longer service life of the components inside the enclosure and the cooling unit due to component-friendly cooling
- Intuitive operation due to touch display and intelligent interfaces

Temperature control:

- e+ controller (factory setting +35 °C)

Protection category IP to IEC 60 529:

- Internal circuit IP 55

Supply includes:

- Nano-coated condenser
- Integral electric condensate evaporation
- Assembly parts
- Fully wired ready for connection (plug-in terminal strip)

Optional:

- For remote monitoring and networking of cooling units and chillers in the Blue e+ generation, please use the IoT interface (Model No. 3124.300). Increase machine availability and process reliability with remote monitoring of device data, statuses and system messages.

Note:

- Please observe the mounting instructions.
- Firmware can be updated using the RiDiag III software (3159.300)

Approvals:

Available on the Internet

Performance diagrams:

Available on the Internet

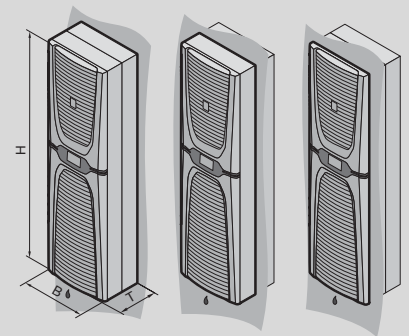

Wall-mounted cooling units Blue e+

Output class 2000 – 2600 W

Model No.		Packs of	3186.630	3186.930	3187.630	3187.930	Page
Material	Sheet steel		–	■	–	■	
	Stainless steel 1.4301 (AISI 304)		■	–	■	–	
Colour	RAL 7035		–	■	–	■	
	RAL 9007		■	–	■	–	
Total cooling output 50 Hz L35 L35 to DIN EN 14511 kW			2	2	2.6	2.6	
Total cooling output 50/60 Hz L35 L35 kW			2 / 2	2 / 2	2.6 / 2.6	2.6 / 2.6	
Total cooling output 50/60 Hz L35 L50 kW			1.29 / 1.29	1.29 / 1.29	1.82 / 1.82	1.82 / 1.82	
Rated operating voltage V, ~, Hz			110 - 240, 1~, 50/60 380 - 480, 3~, 50/60	110 - 240, 1~, 50/60 380 - 480, 3~, 50/60	110 - 240, 1~, 50/60 380 - 480, 3~, 50/60	110 - 240, 1~, 50/60 380 - 480, 3~, 50/60	
Width (B) mm			450	450	450	450	
Height (H) mm			1600	1600	1600	1600	
Depth (T) mm			294	294	294	294	
Rated power input kW			0.73	0.73	1.05	1.05	
Power consumption P _{el} 50/60 Hz L35 L35 kW			0.57 / 0.57	0.57 / 0.57	0.99 / 0.99	0.99 / 0.99	
Operating temperature range			-20 °C...+60 °C	-20 °C...+60 °C	-20 °C...+60 °C	-20 °C...+60 °C	
Setting range			+20 °C...+50 °C	+20 °C...+50 °C	+20 °C...+50 °C	+20 °C...+50 °C	
Energy efficiency ratio (EER) 50/60 Hz L35 L35			3.5 / 3.5	3.5 / 3.5	2.63 / 2.63	2.63 / 2.63	
Seasonal energy efficiency ratio (SEER) 50/60 Hz			8.1	8.1	6.2	6.2	
Refrigerant g			R134a, 1150	R134a, 1150	R134a, 1150	R134a, 1150	
Note on Model No.			–	–	–	–	
Weight kg			54.8	55.2	54.8	55.2	

Accessories							
IoT interface	1 pc(s).	3124.300	3124.300	3124.300	3124.300	554	
Door-operated switch	1 pc(s).	4127.010	4127.010	4127.010	4127.010	1024	
Filter mat	3 pc(s).	3285.900	3285.900	3285.900	3285.900	533	
Metal filter	1 pc(s).	3285.910	3285.910	3285.910	3285.910	534	
Temperature sensor	1 pc(s).	3124.400	3124.400	3124.400	3124.400	549	
Condensate hose	1 pc(s).	3301.612	3301.612	3301.612	3301.612	544	
Eyebolts	4 pc(s).	4568.000	4568.000	4568.000	4568.000	964	
RiDiag	1 pc(s).	3159.300	3159.300	3159.300	3159.300	559	

Output class 4200 – 5800 W

Model No.		Packs of	3188.640	3188.940	3189.640	3189.940	Page
Material	Sheet steel		–	■	–	■	
	Stainless steel 1.4301 (AISI 304)		■	–	■	–	
Colour	RAL 7035		–	■	–	■	
	RAL 9007		■	–	■	–	
Total cooling output 50 Hz L35 L35 to DIN EN 14511 kW			4.2	4.2	5.8	5.8	
Total cooling output 50/60 Hz L35 L35 kW			4.2 / 4.2	4.2 / 4.2	5.8 / 5.8	5.8 / 5.8	
Total cooling output 50/60 Hz L35 L50 kW			3.02 / 3.02	3.02 / 3.02	4.2 / 4.2	4.2 / 4.2	
Rated operating voltage V, ~, Hz			380 - 480, 3~, 50/60	380 - 480, 3~, 50/60	380 - 480, 3~, 50/60	380 - 480, 3~, 50/60	
Width (B) mm			450	450	450	450	
Height (H) mm			1600	1600	1600	1600	
Depth (T) mm			393	393	393	393	
Rated power input kW			1.3	1.3	2.2	2.2	
Power consumption P _{el} 50/60 Hz L35 L35 kW			1.21 / 1.21	1.21 / 1.21	2.2 / 2.2	2.2 / 2.2	
Operating temperature range			-20 °C...+60 °C	-20 °C...+60 °C	-20 °C...+60 °C	-20 °C...+60 °C	
Setting range			+20 °C...+50 °C	+20 °C...+50 °C	+20 °C...+50 °C	+20 °C...+50 °C	
Energy efficiency ratio (EER) 50/60 Hz L35 L35			3.46 / 3.46	3.46 / 3.46	2.64 / 2.64	2.64 / 2.64	
Seasonal energy efficiency ratio (SEER) 50/60 Hz			8.1	8.1	6.2	6.2	
Refrigerant g			R134a, 1750	R134a, 1750	R134a, 1750	R134a, 1750	
Note on Model No.			Full installation not possible	Full installation not possible	Full installation not possible	Full installation not possible	
Weight kg			71.2	72.4	71.2	72.4	

Accessories							
IoT interface	1 pc(s).	3124.300	3124.300	3124.300	3124.300	554	
Door-operated switch	1 pc(s).	4127.010	4127.010	4127.010	4127.010	1024	
Filter mat	3 pc(s).	3285.900	3285.900	3285.900	3285.900	533	
Metal filter	1 pc(s).	3285.910	3285.910	3285.910	3285.910	534	
Temperature sensor	1 pc(s).	3124.400	3124.400	3124.400	3124.400	549	
Condensate hose	1 pc(s).	3301.612	3301.612	3301.612	3301.612	544	
Eyebolts	4 pc(s).	4568.000	4568.000	4568.000	4568.000	964	
RiDiag	1 pc(s).	3159.300	3159.300	3159.300	3159.300	559	

TopTherm wall-mounted cooling units Blue e, NEMA 4X



Accessories for climate control Page 533 Therm software Page 558 RiDiag software Page 559

Energy-efficient Blue e wall-mounted cooling units with e-Comfort controller integrated as standard, RiNano coating on the condenser and electrical condensate evaporation. Protection category NEMA 4X.

Benefits:

- May be linked to the IoT interface via the Blue e IoT adaptor

Temperature control:

- e-Comfort controller (factory setting +35 °C)

Protection category IP to IEC 60 529:

- External circuit IP 34
- Internal circuit IP 55

Protection category NEMA:

- NEMA 4X

Supply includes:

- Nano-coated condenser
 - Fully wired ready for connection (plug-in terminal strip)
 - Drilling template
 - Assembly parts
- Please observe the product-specific scope of supply.

Approvals:

Available on the Internet

Performance diagrams:

Available on the Internet

Output class 500 – 1500 W

Model No.		Packs of	3303.504	3303.514	3304.504	3304.544	3305.504	3305.544	Page
Material	Stainless steel 1.4404 (AISI 316L)		■	■	■	■	■	■	
Total cooling output 50 Hz L35 L35 to DIN EN 14511 kW			0.55	–	1.1	1.1	1.6	1.6	
Total cooling output 50/60 Hz L35 L35 kW			0.55 / 0.66	0.66	1.1 / 1.25	1.1 / 1.26	1.6 / 1.76	1.6 / 1.61	
Total cooling output 50/60 Hz L35 L50 kW			0.33 / 0.4	0.4	0.91 / 0.9	0.98 / 1.09	1.25 / 1.37	1.33 / 1.35	
Rated operating voltage V, ~, Hz			230, 1~, 50/60	115, 1~, 60	230, 1~, 50/60	400, 3~, 50/460, 3~, 60	230, 1~, 50/60	400, 3~, 50/460, 3~, 60	
Width mm			285	285	405	405	405	405	
Height mm			620	620	1020	1020	1020	1020	
Depth mm			298	298	358	358	358	358	
Rated current max. A			2.6 / 2.6	5.7	3.9 / 4.3	2.2 / 2.1	5.5 / 5.8	2.5 / 2.8	
Start-up current A			5.1 / 6.4	11.5	12 / 14	11.5 / 12.7	12 / 14	12.2 / 11.3	
Power consumption P _{el} 50/60 Hz L35 L35 kW			0.39 / 0.41	0.5	0.64 / 0.68	0.64 / 0.79	0.87 / 0.98	0.9 / 1.08	
Operating temperature range			+10 °C...+55 °C	+10 °C...+55 °C	+10 °C...+55 °C	+10 °C...+55 °C	+10 °C...+55 °C	+10 °C...+55 °C	
Setting range			+20 °C...+50 °C	+20 °C...+50 °C	+20 °C...+50 °C	+20 °C...+50 °C	+20 °C...+50 °C	+20 °C...+50 °C	
Energy efficiency ratio (EER) 50/60 Hz L35 L35			1.4	1.31	1.83 / 1.84	1.83 / 1.56	1.83 / 1.79	1.83 / 1.49	
Refrigerant g			R134a, 170	R134a, 170	R134a, 325	R134a, 325	R134a, 500	R134a, 500	
Weight kg			25.0	25.0	49.0	50.0	51.0	52.0	
Product-specific scope of supply									
Integral electric condensate evaporation			–	–	■	■	■	■	
Accessories									
IoT interface		1 pc(s).	3124.300	3124.300	3124.300	3124.300	3124.300	3124.300	554
Blue e IoT adaptor		1 pc(s).	3124.310	3124.310	3124.310	3124.310	3124.310	3124.310	555
Door-operated switch		1 pc(s).	4127.010	4127.010	4127.010	4127.010	4127.010	4127.010	1024
Master/slave cable		1 pc(s).	3124.100	3124.100	3124.100	3124.100	3124.100	3124.100	550
Air diverter		1 pc(s).	–	–	3213.310	3213.310	3213.310	3213.310	542
RiDiag		1 pc(s).	3159.100	3159.100	3159.100	3159.100	3159.100	3159.100	559

TopTherm wall-mounted cooling units Blue e, NEMA 4X

Output class 2000 – 2500 W

Model No.		Packs of	3328.544	3329.544	Page
Material	Stainless steel 1.4404 (AISI 316L)		■	■	
Total cooling output 50 Hz L35 L35 to DIN EN 14511 kW			2.2	2.55	
Total cooling output 50/60 Hz L35 L35 kW			2.2 / 2.55	2.55 / 2.75	
Total cooling output 50/60 Hz L35 L50 kW			1.45 / 1.69	1.9 / 1.95	
Rated operating voltage V, ~, Hz			400, 3~, 50 460, 3~, 60	400, 3~, 50 460, 3~, 60	
Width mm			405	405	
Height mm			1650	1650	
Depth mm			388	388	
Rated current max. A			2.8 / 3.3	3.3 / 3.4	
Start-up current A			6.8 / 7.8	6.8 / 7.6	
Power consumption P _{el} 50/60 Hz L35 L35 kW			0.92 / 1.15	1.19 / 1.39	
Operating temperature range			+10 °C...+50 °C	+10 °C...+50 °C	
Setting range			+20 °C...+50 °C	+20 °C...+50 °C	
Energy efficiency ratio (EER) 50/60 Hz L35 L35			2.4 / 2.22	2.11 / 1.97	
Refrigerant g			R134a, 900	R134a, 900	
Weight kg			81.0	84.0	
Product-specific scope of supply					
Integral electric condensate evaporation			■	■	
Accessories					
IoT interface	1 pc(s).		3124.300	3124.300	554
Blue e IoT adaptor	1 pc(s).		3124.310	3124.310	555
Door-operated switch	1 pc(s).		4127.010	4127.010	1024
Master/slave cable	1 pc(s).		3124.100	3124.100	550
Air diverter	1 pc(s).		3213.320	3213.320	542
RiDiag	1 pc(s).		3159.100	3159.100	559

Rittal – The System.



Therm software

see page 558

Wall-mounted cooling unit TopTherm Blue e, UL Type 3R/4

For indoor and outdoor



Suitable for outdoor siting

- Vandalism-protected (e-Comfort controller on the rear of the cooling unit)
- Outdoor paint finish in accordance with UL 1332
- Temperature range: -20 °C to +50 °C (in compressor mode +10 °C to +50 °C)

Optimum protection

- Protection category: UL Type 3R/4/12 and IP 56
- The cooling units provide protection against damaging influences, e.g. water and external icing
- The RiNano coating prevents the accumulation of dirt deposits on the condenser, thereby extending maintenance intervals and ensuring a constant long-term cooling output

Benefits of Blue e technology

- Energy savings of up to 45%
- Intelligent control with Comfort controller, icing protection and motor monitoring
- Eco-mode control: The evaporator coil fan cuts out as necessary, depending on the enclosure internal temperature
- Longer service life of components in the enclosure and cooling units, because efficient components such as fans and compressors run at their optimum operating point
- The integral electric condensate evaporation system means that condensate evaporates and dissipates to the ambient air via the external fan

Worldwide use

- International approvals (cULus Listed, cULus FTTA, CE and EAC)
- Worldwide service and spare parts availability

Intelligent networking

- In conjunction with the IoT interface and Blue e IoT adaptor, it is a simple matter to integrate the cooling units into Industry 4.0 environments
- Condition monitoring of up to 10 cooling units in a master/slave arrangement



TopTherm wall-mounted cooling units Blue e, UL Type 3R/4



Accessories for climate control Page 533 Therm software Page 558 RiDiag software Page 559

Energy-efficient Blue e wall-mounted cooling units with integral e-Comfort controller, RiNano coating on the condenser and electric condensate evaporation as standard, protection category UL Type 3R/4, 12.

Benefits:

- Suitable for outdoor siting
- Blue e technology
- May be linked to the IoT interface via the Blue e IoT adaptor

Temperature control:

- e-Comfort controller (factory setting +35 °C)

Material:

- Sheet steel

Colour:

- RAL 7035

Protection category IP to IEC 60 529:

- External circuit IP 34
- Internal circuit IP 56

Protection category NEMA:

- UL Type 3R
- UL Type 4
- UL Type 12

Supply includes:

- Nano-coated condenser
- Fully wired ready for connection (plug-in terminal strip)
- Connection box
- Drilling template
- Assembly parts

Please observe the product-specific scope of supply.

Note:

- Compressor cooling mode from +10 °C ambient temperature. Only the internal fan is active in the temperature range -20 °C to +10 °C.

Approvals:

Available on the Internet

Performance diagrams:

Available on the Internet

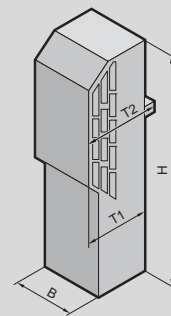

TopTherm wall-mounted cooling units Blue e, UL Type 3R/4

Output class 500 – 2500 W

Model No.	Packs of	3303.508	3303.518	3304.508	3304.548	3305.548	3329.548	Page
Total cooling output 50 Hz L35 L35 to DIN EN 14511 kW		0.46	–	1.1	1.15	1.49	2.55	
Total cooling output 50/60 Hz L35 L35 kW		0.46 / 0.55	0.55	1.1 / 1.26	1.15 / 1.3	1.49 / 1.7	2.55 / 2.75	
Total cooling output 50/60 Hz L35 L50 kW		0.27 / 0.32	0.32	0.9 / 1.07	0.95 / 1.11	1.04 / 1.17	1.95 / 2.00	
Rated operating voltage V, ~, Hz		230, 1~, 50/60	115, 1~, 60	230, 1~, 50/60	400, 3~, 50 460, 3~, 60	400, 3~, 50 460, 3~, 60	400, 3~, 50 460, 3~, 60	
Width (B) mm		285	285	405	405	405	405	
Height (H) mm		620	620	1020	1020	1020	1650	
Depth (T1) mm		298	298	358	358	358	388	
Installation depth of connection box (T2) mm		350	350	410	410	410	440	
Rated current max. A		2.6 / 2.6	5.7	3.9 / 4.3	2.2 / 2.1	2.5 / 2.8	3.3 / 3.4	
Start-up current A		5.1 / 6.4	11.5	12 / 14	11.5 / 12.7	12.2 / 11.3	6.8 / 7.6	
Power consumption P _{el} 50/60 Hz L35 L35 kW		0.35 / 0.42	0.42	0.62 / 0.68	0.75 / 0.78	0.65 / 0.82	1.19 / 1.39	
Operating temperature range		-20 °C...+50 °C	-20 °C...+50 °C	-20 °C...+50 °C	-20 °C...+50 °C	-20 °C...+50 °C	-20 °C...+50 °C	
Setting range		+20 °C...+50 °C	+20 °C...+50 °C	+20 °C...+50 °C	+20 °C...+50 °C	+20 °C...+50 °C	+20 °C...+50 °C	
Energy efficiency ratio (EER) 50/60 Hz L35 L35		1.31 / 1.3	1.3	1.75 / 1.86	1.53 / 1.67	2.28 / 2.07	2.14 / 1.97	
Refrigerant g		R134a, 170	R134a, 170	R134a, 325	R134a, 325	R134a, 500	R134a, 900	
Weight kg		25.0	25.0	49.0	50.0	52.0	84.0	
Product-specific scope of supply								
Integral electric condensate evaporation		–	–	■	■	■	■	
Accessories								
IoT interface	1 pc(s).	3124.300	3124.300	3124.300	3124.300	3124.300	3124.300	554
Blue e IoT adaptor	1 pc(s).	3124.310	3124.310	3124.310	3124.310	3124.310	3124.310	555
Door-operated switch	1 pc(s).	4127.010	4127.010	4127.010	4127.010	4127.010	4127.010	1024
RiDiag	1 pc(s).	3159.100	3159.100	3159.100	3159.100	3159.100	3159.100	559
Master/slave cable	1 pc(s).	3124.100	3124.100	3124.100	3124.100	3124.100	3124.100	550
Air diverter	1 pc(s).	–	–	3213.310	3213.310	3213.310	3213.320	542
Eyebolts	4 pc(s).	4568.000	4568.000	4568.000	4568.000	4568.000	4568.000	964

Climate control

Rittal – The System.



Rittal – The System.
Faster – better – everywhere.

Machine approvals
in North America
under the new NEC 2017

Machine approvals in North America under the new NEC 2017

www.rittal.com/downloads

Wall-mounted cooling unit Blue e+ outdoor

Energy efficiency for the outdoor sector



Suitable for outdoor siting

- Vandalism-protected enclosure (e+ controller on the rear of the cooling unit)
- For universal mounting on outdoor enclosures
- Aluminium enclosure with outdoor spray finish to UL 1332
- Temperature range: -30 °C to +60 °C

Optimum protection

- Protection category: UL type 3R/4/12 and IP 56
- The cooling units provide protection against damage e.g. from water and external icing
- The RiNano coating prevents the accumulation of dirt deposits on the condenser, thereby extending maintenance intervals and ensuring a consistent cooling output for longer

Intelligent networking

In conjunction with the IoT interface, all Blue e+ cooling units can now be networked and digitalised

- Continuous monitoring of temperature levels
- Avoidance of downtime costs and consequential damage
- Automatic notification of any cooling unit malfunctions
- Asset management: Localisation and organisation of cooling units
- Remote access: Device parameters can be configured remotely

Benefits of Blue e+ technology

- Efficiency – Average 75% energy savings thanks to speed-controlled components and heat pipe technology
- Versatility – Unique multi-voltage capability supports global use
- Reliability – Component-friendly cooling helps extend the service life of all components inside the enclosure and the cooling unit
- User-friendliness – Touch display and smart interfaces support intuitive operation

Global use

- International approvals (cULus Listed, cULus FTTA, CE and EAC)
- Worldwide service and spare parts availability



Wall-mounted cooling unit Blue e+ outdoor

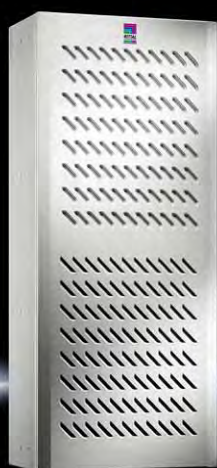

Accessories for climate control Page 533 Toptec Page 270 RiDiag software Page 559

The energy-efficient wall-mounted cooling unit Blue e+ Outdoor can be used worldwide, thanks to its multi-voltage capability, and is suitable for use with Toptec project solutions, for example.

Benefits:

- Average 75% energy savings thanks to speed-regulated components and heat pipe technology
- Longer service life of the components inside the enclosure and the cooling unit due to component-friendly cooling
- Intuitive operation due to touch display and intelligent interfaces

Temperature control:

- e+ controller (factory setting +35 °C)

Material:

- Aluminium AlMg3

Surface finish:

- Powder-coated
- UV-resistant pure polyester

Colour:

- RAL 7035

Protection category IP to IEC 60 529:

- Internal circuit IP 56

Protection category NEMA:

- UL Type 4/3R/12

Supply includes:

- Nano-coated condenser
- Integral electric condensate evaporation
- Fully wired ready for connection (plug-in terminal strip)
- Sealing frame for universal attachment to outdoor enclosures for external, partial internal and full internal mounting.
- Assembly parts

Approvals:

Available on the Internet

Performance diagrams:

Available on the Internet

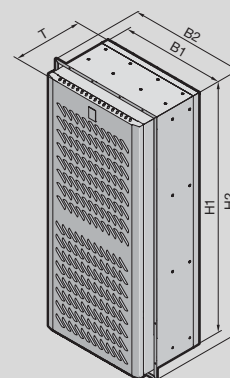

Climate control

Output class 1500 W

Model No.	Packs of	3185.330	Page
Total cooling output 50 Hz L35 L35 to DIN EN 14511 kW		1.5	
Total cooling output 50/60 Hz L35 L35 kW		1.5 / 1.5	
Total cooling output 50/60 Hz L35 L50 kW		1.2 / 1.2	
Rated operating voltage V, ~, Hz		110 - 240, 1~, 50/60 380 - 480, 3~, 50/60	
Width (B1) mm		415	
Height (H1) mm		990	
Depth (T) mm		279	
Enclosure dimensions including sealing frame and designer cover (B2 x H2 x T) mm		467 x 1042 x 279	
Dimensions to fit enclosure type		Toptec	
with height mm		≥ 1200	
with width mm		≥ 600	
Rated power input kW		0.62	
Power consumption P _{el} 50/60 Hz L35 L35 kW		0.54 / 0.54	
Operating temperature range		-30 °C...+60 °C	
Setting range		+20 °C...+50 °C	
Energy efficiency ratio (EER) 50/60 Hz L35 L35		3.1 / 3.1	
Seasonal energy efficiency ratio (SEER) 50/60 Hz		6.4	
Refrigerant g		R134a, 750	
Weight kg		37.1	

Also required

Enclosure heater		see page	531
Thermostat	1 pc(s).	3110.000	547
Hygostat	1 pc(s).	3118.000	547

Accessories

IoT interface	1 pc(s).	3124.300	554
Door-operated switch	1 pc(s).	4127.010	1024

TopTherm roof-mounted cooling units Blue e



Accessories for climate control Page 533 Therm software Page 558 RiDiag software Page 559 Air routing Page 540

Energy-efficient Blue e roof-mounted cooling units with integral e-Comfort controller, RiNano coating on the condenser and electric condensate evaporation as standard.

Benefits:

- May be linked to the IoT interface via the Blue e IoT adaptor

Temperature control:

- e-Comfort controller (factory setting +35 °C)

Protection category IP to IEC 60 529:

- External circuit IP 34
- Internal circuit IP 54

Supply includes:

- Nano-coated condenser
- Integral electric condensate evaporation
- Fully wired ready for connection (plug-in terminal strip)
- Drilling template
- Assembly parts

Note:

- The roof-mounted cooling unit 3273.500 is also suitable for office applications, thanks to its low noise level.

Approvals:

Available on the Internet

Performance diagrams:

Available on the Internet

Output class 500 W

Model No.	Packs of	3382.500	3382.510	3382.600	Page
Material	Sheet steel	■	■	–	
	Stainless steel 1.4301 (AISI 304)	–	–	■	
Colour	RAL 7035	■	■	–	
	RAL 9007	–	–	■	
Total cooling output 50 Hz L35 L35 to DIN EN 14511 kW		0.55	0.55	0.55	
Total cooling output 50/60 Hz L35 L35 kW		0.55 / 0.62	0.55 / 0.62	0.55 / 0.62	
Total cooling output 50/60 Hz L35 L50 kW		0.42 / 0.48	0.42 / 0.48	0.42 / 0.48	
Rated operating voltage V, ~, Hz		230, 1~, 50/60	115, 1~, 50/60	230, 1~, 50/60	
Width mm		597	597	597	
Height mm		417	417	417	
Depth mm		380	380	380	
Rated current max. A		2.3 / 2.6	4.7 / 5.4	2.3 / 2.6	
Start-up current A		9.1 / 8.8	18.2 / 15.9	9.1 / 8.8	
Power consumption P _{el} 50/60 Hz L35 L35 kW		0.27 / 0.31	0.27 / 0.31	0.27 / 0.31	
Operating temperature range		+10 °C...+55 °C	+10 °C...+55 °C	+10 °C...+55 °C	
Operating temperature (max.) 60 Hz		–	–	–	
Setting range		+20 °C...+55 °C	+20 °C...+55 °C	+20 °C...+55 °C	
Energy efficiency ratio (EER) 50/60 Hz L35 L35		2.04 / 1.96	2.04 / 1.96	2.04 / 1.96	
Refrigerant g		R134a, 300	R134a, 300	R134a, 300	
Weight kg		30.0	35.0	30.0	

Accessories

Accessories	Packs of	3382.500	3382.510	3382.600	Page
IoT interface	1 pc(s).	3124.300	3124.300	3124.300	554
Blue e IoT adaptor	1 pc(s).	3124.310	3124.310	3124.310	555
Filter mat	3 pc(s).	3286.500	3286.500	3286.500	533
Door-operated switch	1 pc(s).	4127.010	4127.010	4127.010	1024
Metal filter	1 pc(s).	3286.510	3286.510	3286.510	534
Air duct system	1 pc(s).	3286.870	3286.870	3286.870	540
Shallow air duct system	1 pc(s).	3286.850	3286.850	3286.850	541
Air duct adaptor	1 pc(s).	3286.840	3286.840	3286.840	540
Stoppers	2 pc(s).	3286.780	3286.780	3286.780	542

TopTherm roof-mounted cooling units Blue e

Output class 750 W

Model No.		Packs of	3359.500	3359.510	3359.540	3359.600	Page
Material	Sheet steel		■	■	■	–	
	Stainless steel 1.4301 (AISI 304)		–	–	–	■	
Colour	RAL 7035		■	■	■	–	
	RAL 9007		–	–	–	■	
Total cooling output 50 Hz L35 L35 to DIN EN 14511 kW			0.77	0.77	0.77	0.77	
Total cooling output 50/60 Hz L35 L35 kW			0.77 / 0.79	0.77 / 0.79	0.77 / 0.79	0.77 / 0.79	
Total cooling output 50/60 Hz L35 L50 kW			0.52 / 0.47	0.52 / 0.47	0.52 / 0.47	0.52 / 0.47	
Rated operating voltage V, ~, Hz			230, 1~, 50/60	115, 1~, 50/60	400, 2~, 50/60	230, 1~, 50/60	
Width mm			597	597	597	597	
Height mm			417	417	417	417	
Depth mm			380	380	380	380	
Rated current max. A			2.8 / 3.7	5.6 / 7.4	1.6 / 2.1	2.8 / 3.7	
Start-up current A			9.2 / 9	18.4 / 18	5.4 / 5.2	9.2 / 9	
Power consumption P _{el} 50/60 Hz L35 L35 kW			0.33 / 0.42	0.33 / 0.43	0.33 / 0.43	0.33 / 0.42	
Operating temperature range			+10 °C...+55 °C	+10 °C...+55 °C	+10 °C...+55 °C	+10 °C...+55 °C	
Operating temperature (max.) 60 Hz			–	–	–	–	
Setting range			+20 °C...+55 °C	+20 °C...+55 °C	+20 °C...+55 °C	+20 °C...+55 °C	
Energy efficiency ratio (EER) 50/60 Hz L35 L35			2.28 / 1.85	2.28 / 1.82	2.28 / 1.82	2.28 / 1.85	
Refrigerant g			R134a, 400	R134a, 400	R134a, 400	R134a, 400	
Weight kg			32.0	37.0	37.0	32.0	

Accessories

IoT interface	1 pc(s).	3124.300	3124.300	3124.300	3124.300	554
Blue e IoT adaptor	1 pc(s).	3124.310	3124.310	3124.310	3124.310	555
Filter mat	3 pc(s).	3286.500	3286.500	3286.500	3286.500	533
Door-operated switch	1 pc(s).	4127.010	4127.010	4127.010	4127.010	1024
Metal filter	1 pc(s).	3286.510	3286.510	3286.510	3286.510	534
Air duct system	1 pc(s).	3286.870	3286.870	3286.870	3286.870	540
Shallow air duct system	1 pc(s).	3286.850	3286.850	3286.850	3286.850	541
Air duct adaptor	1 pc(s).	3286.840	3286.840	3286.840	3286.840	540
Stoppers	2 pc(s).	3286.780	3286.780	3286.780	3286.780	542

Output class 1000 W

Model No.		Packs of	3383.500	3383.510	3383.540	3383.600	Page
Material	Sheet steel		■	■	■	–	
	Stainless steel 1.4301 (AISI 304)		–	–	–	■	
Colour	RAL 7035		■	■	■	–	
	RAL 9007		–	–	–	■	
Total cooling output 50 Hz L35 L35 to DIN EN 14511 kW			1	1	1	1	
Total cooling output 50/60 Hz L35 L35 kW			1 / 1.09	1 / 1.09	1 / 1.09	1 / 1.09	
Total cooling output 50/60 Hz L35 L50 kW			0.71 / 0.81	0.71 / 0.81	0.71 / 0.81	0.71 / 0.81	
Rated operating voltage V, ~, Hz			230, 1~, 50/60	115, 1~, 50/60	400, 2~, 50/60	230, 1~, 50/60	
Width mm			597	597	597	597	
Height mm			417	417	417	417	
Depth mm			475	475	475	475	
Rated current max. A			2.9 / 3.9	6.2 / 8.4	1.7 / 2.2	2.9 / 3.9	
Start-up current A			8.8 / 10.1	14.4 / 15.8	4.6 / 5.7	8.8 / 10.1	
Power consumption P _{el} 50/60 Hz L35 L35 kW			0.38 / 0.47	0.38 / 0.45	0.38 / 0.45	0.38 / 0.47	
Operating temperature range			+10 °C...+55 °C	+10 °C...+55 °C	+10 °C...+55 °C	+10 °C...+55 °C	
Operating temperature (max.) 60 Hz			–	–	–	–	
Setting range			+20 °C...+55 °C	+20 °C...+55 °C	+20 °C...+55 °C	+20 °C...+55 °C	
Energy efficiency ratio (EER) 50/60 Hz L35 L35			2.58 / 2.28	2.58 / 2.28	2.58 / 2.28	2.58 / 2.28	
Refrigerant g			R134a, 650	R134a, 650	R134a, 650	R134a, 650	
Weight kg			40.0	46.0	46.0	40.0	

Accessories

IoT interface	1 pc(s).	3124.300	3124.300	3124.300	3124.300	554
Blue e IoT adaptor	1 pc(s).	3124.310	3124.310	3124.310	3124.310	555
Filter mat	3 pc(s).	3286.500	3286.500	3286.500	3286.500	533
Door-operated switch	1 pc(s).	4127.010	4127.010	4127.010	4127.010	1024
Metal filter	1 pc(s).	3286.510	3286.510	3286.510	3286.510	534
Air duct system	1 pc(s).	3286.870	3286.870	3286.870	3286.870	540
Shallow air duct system	1 pc(s).	3286.850	3286.850	3286.850	3286.850	541
Air duct adaptor		–	–	–	–	540
Stoppers	2 pc(s).	3286.880	3286.880	3286.880	3286.880	542

TopTherm roof-mounted cooling units Blue e

Output class 1100 – 1500 W

Model No.		Packs of	3273.500	3384.500	3384.510	3384.540	3384.600	Page
Material	Sheet steel		■	■	■	■	–	
	Stainless steel 1.4301 (AISI 304)		–	–	–	–	■	
Colour	RAL 7035		■	■	■	■	–	
	RAL 9007		–	–	–	–	■	
Total cooling output 50 Hz L35 L35 to DIN EN 14511 kW			1.1	1.5	1.5	1.5	1.5	
Total cooling output 50/60 Hz L35 L35 kW			1.1 / 1.2	1.5 / 1.65	1.5 / 1.65	1.5 / 1.65	1.5 / 1.65	
Total cooling output 50/60 Hz L35 L50 kW			0.85 / 0.87	1.15 / 1.3	1.15 / 1.3	1.15 / 1.3	1.15 / 1.3	
Rated operating voltage V, ~, Hz			230, 1~, 50/60	230, 1~, 50/60	115, 1~, 50/60	400, 2~, 50/60	230, 1~, 50/60	
Width mm			597	597	597	597	597	
Height mm			417	417	417	417	417	
Depth mm			475	475	475	475	475	
Rated current max. A			5.2 / 5.4	4.2 / 4.9	8.7 / 10.1	2.5 / 2.9	4.2 / 4.9	
Start-up current A			15.5 / 16.5	14.7 / 13.6	27.2 / 23.2	8.7 / 7.6	14.7 / 13.6	
Power consumption P _{el} 50/60 Hz L35 L35 kW			0.51 / 0.53	0.67 / 0.77	0.67 / 0.76	0.67 / 0.76	0.67 / 0.77	
Operating temperature range			+10 °C...+55 °C	+10 °C...+55 °C	+10 °C...+55 °C	+10 °C...+55 °C	+10 °C...+55 °C	
Operating temperature (max.) 60 Hz			+50 °C	–	–	–	–	
Setting range			+20 °C...+55 °C	+20 °C...+55 °C	+20 °C...+55 °C	+20 °C...+55 °C	+20 °C...+55 °C	
Energy efficiency ratio (EER) 50/60 Hz L35 L35			2.12 / 2.23	2.24 / 2.13	2.24 / 2.13	2.24 / 2.13	2.24 / 2.13	
Refrigerant g			R134a, 700	R134a, 700	R134a, 700	R134a, 700	R134a, 700	
Weight kg			42.0	41.0	47.0	47.0	41.0	

Accessories

IoT interface	1 pc(s).	3124.300	3124.300	3124.300	3124.300	3124.300	554
Blue e IoT adaptor	1 pc(s).	3124.310	3124.310	3124.310	3124.310	3124.310	555
Filter mat	3 pc(s).	3286.500	3286.500	3286.500	3286.500	3286.500	533
Door-operated switch	1 pc(s).	4127.010	4127.010	4127.010	4127.010	4127.010	1024
Metal filter	1 pc(s).	3286.510	3286.510	3286.510	3286.510	3286.510	534
Air duct system	1 pc(s).	3286.870	3286.870	3286.870	3286.870	3286.870	540
Shallow air duct system	1 pc(s).	3286.850	3286.850	3286.850	3286.850	3286.850	541
Air duct adaptor		–	–	–	–	–	540
Stoppers	2 pc(s).	3286.880	3286.880	3286.880	3286.880	3286.880	542

Output class 2000 W

Model No.		Packs of	3385.500	3385.510	3385.540	3385.600	3385.640	Page
Material	Sheet steel		■	■	■	–	–	
	Stainless steel 1.4301 (AISI 304)		–	–	–	■	■	
Colour	RAL 7035		■	■	■	–	–	
	RAL 9007		–	–	–	■	■	
Total cooling output 50 Hz L35 L35 to DIN EN 14511 kW			2	2	2	2	2	
Total cooling output 50/60 Hz L35 L35 kW			2 / 2.14	2 / 2.14	2 / 2.14	2 / 2.14	2 / 2.14	
Total cooling output 50/60 Hz L35 L50 kW			1.41 / 1.51	1.41 / 1.51	1.41 / 1.51	1.41 / 1.51	1.41 / 1.51	
Rated operating voltage V, ~, Hz			230, 1~, 50/60	115, 1~, 50/60	400, 2~, 50/60	230, 1~, 50/60	400, 2~, 50/60	
Width mm			597	597	597	597	597	
Height mm			417	417	417	417	417	
Depth mm			475	475	475	475	475	
Rated current max. A			5.9 / 6.3	13.3 / 13.5	3.5 / 3.7	5.9 / 6.3	3.5 / 3.7	
Start-up current A			19.7 / 17.9	42.2 / 31.1	11.7 / 11.7	19.7 / 17.9	11.7 / 11.7	
Power consumption P _{el} 50/60 Hz L35 L35 kW			0.95 / 1.14	0.95 / 1.17	0.95 / 1.17	0.95 / 1.14	0.95 / 1.17	
Operating temperature range			+10 °C...+55 °C	+10 °C...+55 °C	+10 °C...+55 °C	+10 °C...+55 °C	+10 °C...+55 °C	
Operating temperature (max.) 60 Hz			–	–	–	–	–	
Setting range			+20 °C...+55 °C	+20 °C...+55 °C	+20 °C...+55 °C	+20 °C...+55 °C	+20 °C...+55 °C	
Energy efficiency ratio (EER) 50/60 Hz L35 L35			2.09 / 1.88	2.09 / 1.88	2.09 / 1.88	2.09 / 1.88	2.09 / 1.88	
Refrigerant g			R134a, 900	R134a, 900	R134a, 900	R134a, 900	R134a, 900	
Weight kg			42.0	48.0	48.0	42.0	48.0	

Accessories

IoT interface	1 pc(s).	3124.300	3124.300	3124.300	3124.300	3124.300	554
Blue e IoT adaptor	1 pc(s).	3124.310	3124.310	3124.310	3124.310	3124.310	555
Filter mat	3 pc(s).	3286.500	3286.500	3286.500	3286.500	3286.500	533
Door-operated switch	1 pc(s).	4127.010	4127.010	4127.010	4127.010	4127.010	1024
Metal filter	1 pc(s).	3286.510	3286.510	3286.510	3286.510	3286.510	534
Air duct system	1 pc(s).	3286.870	3286.870	3286.870	3286.870	3286.870	540
Shallow air duct system	1 pc(s).	3286.850	3286.850	3286.850	3286.850	3286.850	541
Air duct adaptor		–	–	–	–	–	540
Stoppers	2 pc(s).	3286.880	3286.880	3286.880	3286.880	3286.880	542

TopTherm roof-mounted cooling units Blue e

Output class 3000 – 4000 W

Model No.	Packs of	3386.540	3386.640	3387.540	3387.640	Page
Material	Sheet steel	■	–	■	–	
	Stainless steel 1.4301 (AISI 304)	–	■	–	■	
Colour	RAL 7035	■	–	■	–	
	RAL 9007	–	■	–	■	
Total cooling output 50 Hz L35 L35 to DIN EN 14511 kW		3	3	3.8	3.8	
Total cooling output 50/60 Hz L35 L35 kW		3 / 3.3	3 / 3.3	3.8 / 4	3.8 / 4	
Total cooling output 50/60 Hz L35 L50 kW		2.2 / 2.5	2.2 / 2.5	3.05 / 3.3	3.05 / 3.3	
Rated operating voltage V, –, Hz		400, 3~, 50 460, 3~, 60	400, 3~, 50 460, 3~, 60	400, 3~, 50 460, 3~, 60	400, 3~, 50 460, 3~, 60	
Width mm		796	796	796	796	
Height mm		470	470	470	470	
Depth mm		580	580	580	580	
Rated current max. A		3.4 / 3.4	3.4 / 3.4	3.9 / 3.9	3.9 / 3.9	
Start-up current A		8 / 9	8 / 9	17 / 19	17 / 19	
Power consumption P _{el} 50/60 Hz L35 L35 kW		1.17 / 1.48	1.17 / 1.48	1.59 / 2.03	1.59 / 2.03	
Operating temperature range		+10 °C...+55 °C	+10 °C...+55 °C	+10 °C...+55 °C	+10 °C...+55 °C	
Operating temperature (max.) 60 Hz		–	–	–	–	
Setting range		+20 °C...+55 °C	+20 °C...+55 °C	+20 °C...+55 °C	+20 °C...+55 °C	
Energy efficiency ratio (EER) 50/60 Hz L35 L35		2.56 / 2.23	2.56 / 2.23	2.38 / 1.97	2.38 / 1.97	
Refrigerant g		R134a, 1600	R134a, 1600	R134a, 1800	R134a, 1800	
Weight kg		70.0	70.0	77.0	77.0	
Accessories						
IoT interface	1 pc(s).	3124.300	3124.300	3124.300	3124.300	554
Blue e IoT adaptor	1 pc(s).	3124.310	3124.310	3124.310	3124.310	555
Filter mat	3 pc(s).	3286.600	3286.600	3286.600	3286.600	533
Door-operated switch	1 pc(s).	4127.010	4127.010	4127.010	4127.010	1024
Metal filter	1 pc(s).	3286.610	3286.610	3286.610	3286.610	534
Air duct system	1 pc(s).	3286.970	3286.970	3286.970	3286.970	540
Shallow air duct system		–	–	–	–	541
Air duct adaptor		–	–	–	–	540
Stoppers	2 pc(s).	3286.980	3286.980	3286.980	3286.980	542



Rittal – The System.

Blue e IoT adaptor

see page 555

VX25 Blue e+ integration solution/ Blue e+ roof-mounted cooling units

With revolutionary efficiency



Time and cost savings

- Plug and play: Cooling unit, door limit switches and cabling are pre-installed and ready to connect
- The cooling unit pulls forwards easily for maintenance purposes

Comfort

- Intuitive operation with touch display

Optimum data quality

- All cooling solutions are available in duplicate – real and digital. Thanks to the digital twin, planning, ordering, machining and much more can be carried out by the person who knows your company the best: You.

Efficiency

- High level of energy efficiency, also when used as an autonomous roof-mounted cooling unit

Ready for Industry 4.0

- Digitalisation and networking offer huge opportunities for every company. With the IoT interface (optional), Rittal cooling solutions are easily connected to Industry 4.0 environments.



Climate control

Blue e+ roof-mounted cooling unit



Accessories for climate control Page 533 Therm software Page 558 RiDiag software Page 559 IoT interface Page 554

Benefits:

- Average 75% energy savings thanks to speed-regulated components and heat pipe technology
- Suitable for international use due to a unique multi-voltage capability
- Longer service life of the components inside the enclosure and the cooling unit due to component-friendly cooling
- Intuitive operation due to touch display and intelligent interfaces

Temperature control:

- e+ controller (factory setting +35 °C)

Protection category IP to IEC 60 529:

- External circuit IP 54 with pleated filter
- Internal circuit IP 54 with pleated filter

Supply includes:

- Blue e+ roof-mounted cooling unit
- Pleated filter
- Fully wired ready for connection
- Assembly parts
- Condensate hose (3 m)

Optional:

- For remote monitoring and networking of cooling units and chillers in the Blue e+ generation, please use the IoT interface (Model No. 3124.300). Increase machine availability and process reliability with remote monitoring of device data, statuses and system messages.

Note:

- Only suitable for mounting on enclosures with minimum dimensions (W x D) 800 x 600 mm
- Operation without a pleated filter is inadmissible
- Firmware can be updated using the RiDiag III software (3159.300)

Approvals:

Available on the Internet

Performance diagrams:

Available on the Internet

Output class 1300 W

Model No.	Packs of	3185.730	Page
Material	Sheet steel	■	
Colour	RAL 7035	■	
Total cooling output 50 Hz L35 L35 to DIN EN 14511 kW		1.3	
Total cooling output 50/60 Hz L35 L35 kW		1.3 / 1.3	
Total cooling output 50/60 Hz L35 L50 kW		0.76 / 0.76	
Rated operating voltage V, ~, Hz		110 - 240, 1~, 50/60 380 - 480, 3~, 50/60	
Width mm		700	
Height mm		308	
Depth mm		560	
Rated power input kW		0.75	
Power consumption P _{el} 50/60 Hz L35 L35 kW		0.67 / 0.67	
Operating temperature range		-20 °C...+55 °C	
Setting range		+20 °C...+50 °C	
Energy efficiency ratio (EER) 50/60 Hz L35 L35		2.04 / 2.04	
Seasonal energy efficiency ratio (SEER) 50/60 Hz		5.3	
Refrigerant g		R134a, 590	
Weight kg		38.0	
Accessories			
IoT interface	1 pc(s).	3124.300	554
Door-operated switch	1 pc(s).	4127.010	1024
Pleated filter	3 pc(s).	3285.700	536
Temperature sensor	1 pc(s).	3124.400	549
Display frame	1 pc(s).	3355.700	557
Electrical condensate evaporation	1 pc(s).	3355.720	543
RiDiag	1 pc(s).	3159.300	559

VX25 Blue e+ integration solution



Accessories for climate control Page 533 RiDiag software Page 559 Blue e+ roof-mounted cooling unit Page 504 IoT interface Page 554

Benefits:

- The perfect symbiosis of the VX25 baying enclosure system and Blue e+ cooling unit
- The cooling unit is easily pulled out forwards for maintenance purposes
- No assembly work required – the cooling unit, door-operated switch and connection cabling are installed ready-to-connect
- Cooling unit offers all the benefits of Blue e+ Technology

Temperature control:

- e+ controller (factory setting +35 °C)

Protection category IP to IEC 60 529:

- External circuit IP 54 with pleated filter
- Internal circuit IP 54 with pleated filter

Supply includes:

- Basic enclosure VX25, door, roof, rear panel, side panels, gland plates, mounting plate
- Lock: 3 mm double-bit
- Integral door-operated switch
- Integral Blue e+ cooling unit
- Electric condensate evaporator
- Pleated filter
- Condensate hose (3 m)

Optional:

- For remote monitoring and networking of cooling units and chillers in the Blue e+ generation, please use the IoT interface (Model No. 3124.300). Increase machine availability and process reliability with remote monitoring of device data, statuses and system messages.

Note:

- Operation without a pleated filter is inadmissible
- Firmware can be updated using the RiDiag III software (3159.300)

Approvals:

Available on the Internet

Performance diagrams:

Available on the Internet

Climate control

Output class 1300 W

Model No.	Packs of	3185.030	Page
Material	Sheet steel	■	
Colour	RAL 7035	■	
Total cooling output 50 Hz L35 L35 to DIN EN 14511 kW		1.3	
Total cooling output 50/60 Hz L35 L35 kW		1.3 / 1.3	
Total cooling output 50/60 Hz L35 L50 kW		0.76 / 0.76	
Rated operating voltage V, ~, Hz		110 - 240, 1~, 50/60 380 - 480, 3~, 50/60	
Width mm		800	
Height mm		2200	
Depth mm		600	
Mounting plate width mm		699	
Mounting plate height mm		1696	
Rated power input kW		0.75	
Power consumption P _{el} 50/60 Hz L35 L35 kW		0.67 / 0.67	
Operating temperature range		-20 °C...+55 °C	
Setting range		+20 °C...+50 °C	
Energy efficiency ratio (EER) 50/60 Hz L35 L35		2.04 / 2.04	
Seasonal energy efficiency ratio (SEER) 50/60 Hz		5.3	
Refrigerant g		R134a, 590	
Weight kg		180.0	
Accessories			
IoT interface	1 pc(s).	3124.300	554
Pleated filter	3 pc(s).	3285.700	536
Temperature sensor	1 pc(s).	3124.400	549
Display frame	1 pc(s).	3355.700	557

Modular climate control concept – cooling module Blue e



Accessories for climate control Page 533 VX25 enclosures Page 116 Therm software Page 558 RiDiag software Page 559

All cooling modules may be individually combined with any climate control door. The cooling modules are equipped with energy-efficient Blue e technology, with integral e-Comfort controller, RiNano coating on the condenser and electric condensate evaporation as standard.

Benefits:

- May be linked to the IoT interface via the Blue e IoT adaptor

Temperature control:

- e-Comfort controller (factory setting +35 °C)

Material:

- Sheet steel

Colour:

- RAL 7035

Protection category IP to IEC 60 529:

- External circuit IP 34
- Internal circuit IP 54

Supply includes:

- Cooling module prepared for installation in climate control door
- Nano-coated condenser
- Integral electric condensate evaporation
- Fully wired ready for connection (plug-in terminal strip)

Note:

- A base/plinth with a height of 100 or 200 mm is required for efficient operation

Approvals:

Available on the Internet

Performance diagrams:

Available on the Internet

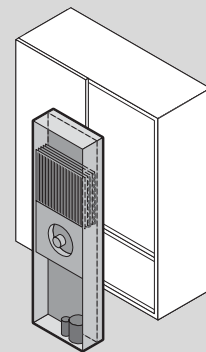

Output class 1500 – 2500 W

Model No.	Packs of	3307.700	3307.740	3310.700	3310.740	Page
Rated operating voltage V, ~, Hz		230, 1~, 50/60	400, 3~, 50 460, 3~, 60	230, 1~, 50/60	400, 3~, 50 460, 3~, 60	
Total cooling output 50/60 Hz L35 L35 kW		1.5 / 1.55	1.5 / 1.55	2.5 / 2.52	2.5 / 2.5	
Total cooling output 50/60 Hz L35 L50 kW		0.85 / 0.9	0.93 / 0.95	1.62 / 1.76	1.76 / 1.8	
Rated current max. A		6 / 6.1	2.5 / 2.7	7.6 / 9.4	3.5 / 3.7	
Start-up current A		22 / 24	8.5 / 9.2	22 / 24	13 / 14	
Power consumption P _{el} 50/60 Hz L35 L35 kW		0.85 / 1.05	0.79 / 1	1.31 / 1.52	1.13 / 1.48	
Operating temperature range		+10 °C...+55 °C	+10 °C...+55 °C	+10 °C...+55 °C	+10 °C...+55 °C	
Setting range		+20 °C...+55 °C	+20 °C...+55 °C	+20 °C...+55 °C	+20 °C...+55 °C	
Energy efficiency ratio (EER) 50/60 Hz L35 L35		1.76 / 1.48	1.9 / 1.55	1.91 / 1.66	2.21 / 1.69	
Refrigerant g		R134a, 700	R134a, 700	R134a, 1175	R134a, 1175	
Weight kg		68.0	68.0	73.0	72.0	

Also required

Modular climate control concept – climate control door VX25		see page	see page	see page	see page	507
---	--	----------	----------	----------	----------	-----

Accessories

IoT interface	1 pc(s).	3124.300	3124.300	3124.300	3124.300	554
Blue e IoT adaptor	1 pc(s).	3124.310	3124.310	3124.310	3124.310	555
Master/slave cable	1 pc(s).	3124.100	3124.100	3124.100	3124.100	550
Door-operated switch	1 pc(s).	4127.010	4127.010	4127.010	4127.010	1024

Modular climate control concept – climate control door VX25

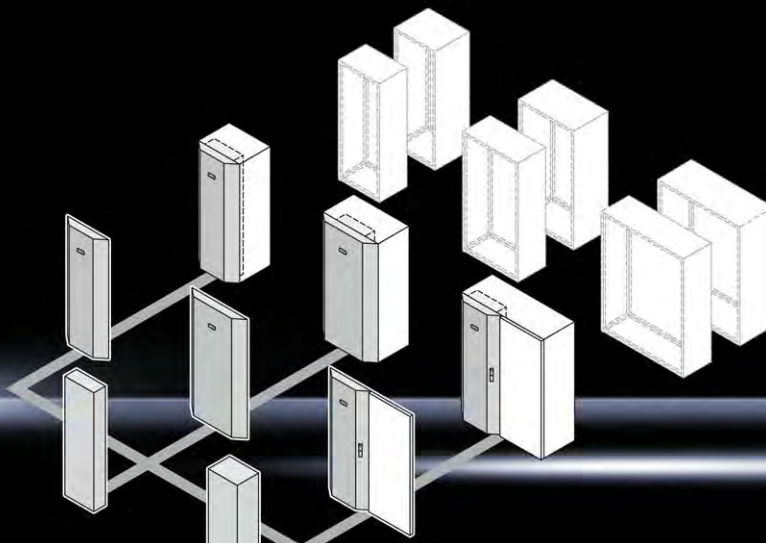

Accessories for climate control Page 533 VX25 enclosures Page 116 Therm software Page 558

Sheet steel climate control doors for the installation of climate control module types SK 3307.7XX to 3310.7XX. The climate control doors fit perfectly with the overall design of the enclosure.

Material:

- Sheet steel

Colour:

- RAL 7035

Supply includes:

- Climate control door without preconfigured cooling module
- 180° hinges, door opening angle approx. 130°

Note:

- To fit VX enclosures
- For 1200 mm wide VX enclosures, the existing hinged door may be used, irrespective of the device position (left or right)

Approvals:

Available on the Internet

Climate control

for installing cooling modules

Model No.	Packs of	3201.800	3201.810	3201.820	3201.830	3201.840	3201.850	Page
Dimensions to fit enclosure type		VX	VX	VX	VX	VX	VX	
with height mm		1800	2000	1800	2000	1800	2000	
with width mm		600 1200	600 1200	800	800	600 1200	600 1200	
Unit positioned on the left		-	-	-	-	■	■	
Note on Model No.		R/h door hinge	R/h door hinge	R/h door hinge	R/h door hinge	L/h door hinge	L/h door hinge	
Weight kg		19.0	20.0	27.0	31.0	19.0	22.0	
Also required								
Modular climate control concept - cooling module Blue e		see page	see page	see page	see page	see page	see page	506
Accessories								
Metal filter	1 pc(s).	3284.210	3284.210	3284.210	3284.210	3284.210	3284.210	534
Comfort handle VX	1 pc(s).	8618.250	8618.250	8618.250	8618.250	8618.250	8618.250	937
Ride-up roller	10 pc(s).	-	8618.420	-	8618.420	-	8618.420	956

Rittal – The System.

Faster – better – everywhere.



Liquid cooling

Air/water heat exchangers

Wall-mounted	300 – 600 W	510
Wall-mounted	950 – 1250 W	511
Wall-mounted	2000 – 2800 W	512
Wall-mounted	3000 W	512
Wall-mounted	4500 – 5000 W	513
Wall-mounted	7000 W	514
Wall-mounted HD	600 – 1200 W	515
Roof-mounted	1875 – 3000 W	516
Roof-mounted	4000 W	517

Liquid Cooling Package

LCP Rack Industry	10000 W	518
-------------------------	---------------	-----

Chillers

TopTherm, roof-mounted	1000 – 1500 W	519
Product advantages	520
Blue e+	2500 – 6500 W	522
Product advantages	524
Blue e	11000 – 15000 W	526
Blue e	20000 – 25000 W	527
VX25 TopTherm	8000 – 12000 W	528
VX25 TopTherm	16000 – 25000 W	529



The DGUV test certificate applies to HD air/water heat exchangers.

Air/water heat exchangers



Accessories for climate control Page 533 Chillers Page 519 Therm software Page 558

For use in harsh environments and temperature ranges up to +70 °C. User-friendly assembly plus flexible water connection options. External mounting or full internal mounting are supported.

Colour:

- RAL 7035

Protection category IP to IEC 60 529:

- IP 55

Cooling medium:

- Water (see Internet for specifications)

Supply includes:

- Fully wired ready for connection
- Drilling template
- Sealing and assembly parts

Note:

- Integral non-return valve for version with e-Comfort controller

Approvals:

Available on the Internet

Performance diagrams:

Available on the Internet

Output class 300 – 600 W, wall-mounted

Model No.	Packs of	3212.024	3212.230	3363.100	3363.500	3214.100	Page
Design	Water-carrying parts, copper/brass (Cu/CuZn)	■	■	■	■	■	
Temperature control	Basic controller (factory setting +35 °C)	-	-	■	-	-	
	e-Comfort controller (factory setting +35 °C)	-	-	-	■	-	
	Thermostat-controlled magnetic valve	-	-	-	-	■	
Total cooling output L35 W10, 200 l/h kW		0.3	0.3	-	-	0.6	
Total cooling output L35 W10, 400 l/h kW		-	-	0.5	0.5	0.7	
Power consumption P _{el} 50/60 Hz W		-	23 / 27	37 / 38	37 / 38	36 / 37	
Power consumption P _{el} W		26	-	-	-	-	
Rated operating voltage V		24 (DC)	230, 1~, 50/60	230, 1~, 50/60	230, 1~, 50/60	230, 1~, 50/60	
Width mm		150	150	280	280	200	
Height mm		300	300	550	550	500	
Depth mm		85	85	120	120	100	
Rated current max. A		1.2	0.11 / 0.13	0.18 / 0.18	0.18 / 0.18	0.17 / 0.18	
Operating temperature range		+1 °C...+70 °C	+1 °C...+70 °C	+1 °C...+70 °C	+1 °C...+70 °C	+1 °C...+70 °C	
Setting range		-	-	+20 °C...+55 °C	+20 °C...+55 °C	+20 °C...+55 °C	
Water inlet temperature		+1 °C...+30 °C	+1 °C...+30 °C	+1 °C...+30 °C	+1 °C...+30 °C	+1 °C...+30 °C	
Water connection	½" connector sleeve	-	-	■	■	■	
	G ¾" external thread	-	-	■	■	-	
	¾" connector sleeve	■	■	-	-	-	
Permissible operating pressure (p) bar		1 - 10	1 - 10	1 - 10	1 - 10	1 - 10	
Air throughput of fans (unimpeded air flow), Internal circuit 50/60 Hz m³/h		-	280 / 310	290 / 345	290 / 345	280 / 310	
Air throughput of fans (unimpeded air flow), Internal circuit with DC m³/h		250	-	-	-	-	
Weight as delivered kg		3.2	3.2	8.0	8.0	7.0	

Accessories

Condensate hose	1 pc(s).	3301.610	3301.610	3301.612	3301.612	3301.612	544
Door-operated switch	1 pc(s).	4127.010	4127.010	4127.010	4127.010	4127.010	1024
Toroidal transformer		-	see page	see page	see page	see page	550
Flow regulator valve		see page	see page	see page	see page	see page	545

Air/water heat exchangers

Output class 950 – 1250 W, wall-mounted

Model No.		Packs of	3364.504	3364.100	3364.500	3215.100	Page
Design	Water-carrying parts, copper/brass (Cu/CuZn)		–	■	■	■	
	Water-carrying parts, stainless steel (1.4571)		■	–	–	–	
Temperature control	Basic controller (factory setting +35 °C)		–	■	–	–	
	e-Comfort controller (factory setting +35 °C)		■	–	■	–	
	Thermostat-controlled magnetic valve		–	–	–	■	
Total cooling output L35 W10, 200 l/h kW			–	–	–	1.25	
Total cooling output L35 W10, 400 l/h kW			0.95	1	1	1.3	
Power consumption P _{el} 50/60 Hz W			37 / 38	37 / 38	37 / 38	83 / 85	
Power consumption P _{el}			–	–	–	–	
Rated operating voltage V, ~, Hz			230, 1~, 50/60	230, 1~, 50/60	230, 1~, 50/60	230, 1~, 50/60	
Width mm			280	280	280	200	
Height mm			550	550	550	950	
Depth mm			120	120	120	100	
Rated current max. A			0.18 / 0.18	0.18 / 0.18	0.18 / 0.18	0.38 / 0.4	
Operating temperature range			+1 °C...+70 °C	+1 °C...+70 °C	+1 °C...+70 °C	+1 °C...+70 °C	
Setting range			+20 °C...+55 °C	+20 °C...+55 °C	+20 °C...+55 °C	+20 °C...+55 °C	
Water inlet temperature			+1 °C...+30 °C	+1 °C...+30 °C	+1 °C...+30 °C	+1 °C...+30 °C	
Water connection	½" connector sleeve		■	■	■	■	
	G ¾" external thread		■	■	■	–	
Permissible operating pressure (p) bar			1 - 10	1 - 10	1 - 10	1 - 10	
Air throughput of fans (unimpeded air flow), Internal circuit 50/60 Hz m³/h			290 / 345	290 / 345	290 / 345	680 / 735	
Air throughput of fans (unimpeded air flow), Internal circuit with DC			–	–	–	–	
Weight as delivered kg			9.0	9.0	9.0	13.0	
Accessories							
Condensate hose		1 pc(s).	3301.612	3301.612	3301.612	3301.612	544
Door-operated switch		1 pc(s).	4127.010	4127.010	4127.010	4127.010	1024
Toroidal transformer			see page	see page	see page	see page	550
Flow regulator valve			see page	see page	see page	see page	545

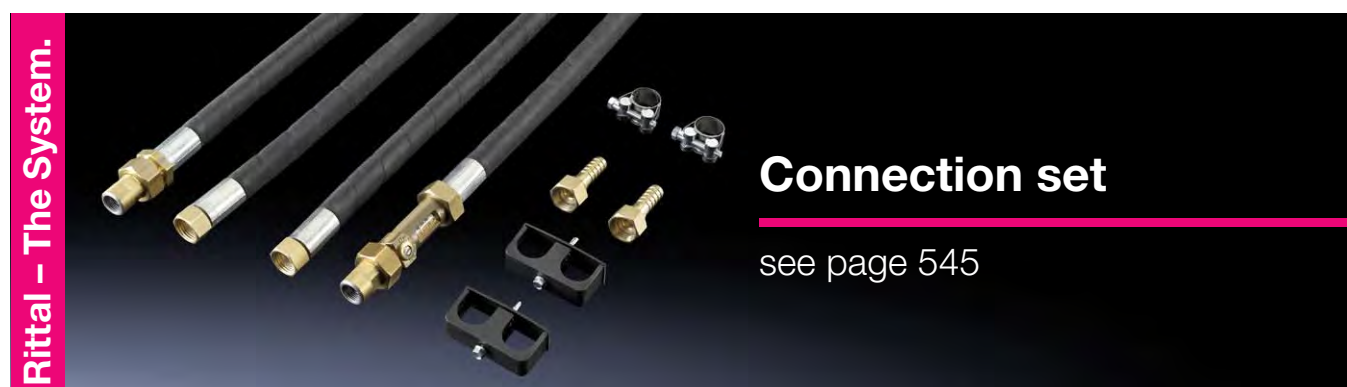

Air/water heat exchangers

Output class 2000 – 2800 W, wall-mounted

Model No.		Packs of	3373.100	3373.140	3373.500	3374.504	Page
Design	Water-carrying parts, copper/brass (Cu/CuZn)		■	■	■	–	
	Water-carrying parts, stainless steel (1.4571)		–	–	–	■	
Temperature control	Basic controller (factory setting +35 °C)		■	■	–	–	
	e-Comfort controller (factory setting +35 °C)		–	–	■	■	
Total cooling output L35 W10, 200 l/h			–	–	–	–	
Total cooling output L35 W10, 400 l/h kW			2	2	2	2.8	
Power consumption P _{el} 50/60 Hz W			110 / 140	110 / 140	110 / 140	169 / 232	
Power consumption P _{el}			–	–	–	–	
Rated operating voltage V, ~, Hz			230, 1~, 50/60	400, 2~, 50/60	230, 1~, 50/60	230, 1~, 50/60	
Width mm			400	400	400	400	
Height mm			950	950	950	950	
Depth mm			145	145	145	145	
Rated current max. A			0.49 / 0.61	0.28 / 0.35	0.49 / 0.61	0.76 / 1.01	
Operating temperature range			+1 °C...+70 °C	+1 °C...+70 °C	+1 °C...+70 °C	+1 °C...+70 °C	
Setting range			+20 °C...+55 °C	+20 °C...+55 °C	+20 °C...+55 °C	+20 °C...+55 °C	
Water inlet temperature			+1 °C...+30 °C	+1 °C...+30 °C	+1 °C...+30 °C	+1 °C...+30 °C	
Water connection	½" connector sleeve		■	■	■	■	
	G ¾" external thread		■	■	■	■	
Permissible operating pressure (p) bar			1 - 10	1 - 10	1 - 10	1 - 10	
Air throughput of fans (unimpeded air flow), Internal circuit 50/60 Hz m³/h			880 / 950	880 / 950	880 / 950	1150 / 1300	
Air throughput of fans (unimpeded air flow), Internal circuit with DC			–	–	–	–	
Weight as delivered kg			20.0	23.0	20.0	23.0	
Accessories							
Condensate hose		1 pc(s).	3301.612	3301.612	3301.612	3301.612	544
Door-operated switch		1 pc(s).	4127.010	4127.010	4127.010	4127.010	1024
Toroidal transformer			–	–	–	–	550
Flow regulator valve			see page	see page	see page	see page	545

Output class 3000 W, wall-mounted

Model No.		Packs of	3374.100	3374.140	3374.500	3374.540	Page
Design	Water-carrying parts, copper/brass (Cu/CuZn)		■	■	■	■	
	Water-carrying parts, stainless steel (1.4571)		–	–	–	–	
Temperature control	Basic controller (factory setting +35 °C)		■	■	–	–	
	e-Comfort controller (factory setting +35 °C)		–	–	■	■	
Total cooling output L35 W10, 200 l/h			–	–	–	–	
Total cooling output L35 W10, 400 l/h kW			3	3	3	3	
Power consumption P _{el} 50/60 Hz W			169 / 232	169 / 232	169 / 232	169 / 232	
Power consumption P _{el}			–	–	–	–	
Rated operating voltage V, ~, Hz			230, 1~, 50/60	400, 2~, 50/60	230, 1~, 50/60	400, 2~, 50/60	
Width mm			400	400	400	400	
Height mm			950	950	950	950	
Depth mm			145	145	145	145	
Rated current max. A			0.76 / 1.01	0.44 / 0.58	0.76 / 1.01	0.44 / 0.58	
Operating temperature range			+1 °C...+70 °C	+1 °C...+70 °C	+1 °C...+70 °C	+1 °C...+70 °C	
Setting range			+20 °C...+55 °C	+20 °C...+55 °C	+20 °C...+55 °C	+20 °C...+55 °C	
Water inlet temperature			+1 °C...+30 °C	+1 °C...+30 °C	+1 °C...+30 °C	+1 °C...+30 °C	
Water connection	½" connector sleeve		■	■	■	■	
	G ¾" external thread		■	■	■	■	
Permissible operating pressure (p) bar			1 - 10	1 - 10	1 - 10	1 - 10	
Air throughput of fans (unimpeded air flow), Internal circuit 50/60 Hz m³/h			1150 / 1300	1150 / 1300	1150 / 1300	1150 / 1300	
Air throughput of fans (unimpeded air flow), Internal circuit with DC			–	–	–	–	
Weight as delivered kg			23.0	26.0	23.0	26.0	
Accessories							
Condensate hose		1 pc(s).	3301.612	3301.612	3301.612	3301.612	544
Door-operated switch		1 pc(s).	4127.010	4127.010	4127.010	4127.010	1024
Toroidal transformer			–	–	–	–	550
Flow regulator valve			see page	see page	see page	see page	545

Air/water heat exchangers

Output class 4500 – 5000 W, wall-mounted

Model No.		Packs of	3375.504	3375.100	3375.500	3375.540	Page
Design	Water carrying parts copper/brass (Cu/CuZn)		–	■	■	■	
	Water-carrying parts, stainless steel (1.4571)		■	–	–	–	
Temperature control	Basic controller (factory setting +35 °C)		–	■	–	–	
	e-Comfort controller (factory setting +35 °C)		■	–	■	■	
Total cooling output L35 W10, 200 l/h			–	–	–	–	
Total cooling output L35 W10, 400 l/h kW			4.5	5	5	5	
Power consumption P _{el} 50/60 Hz W			172 / 172	172 / 172	172 / 172	183 / 183	
Power consumption P _{el}			–	–	–	–	
Rated operating voltage V, ~, Hz			230, 1~, 50/60	230, 1~, 50/60	230, 1~, 50/60	400, 2~, 50/60	
Width mm			450	450	450	450	
Height mm			1400	1400	1400	1400	
Depth mm			220	220	220	220	
Rated current max. A			1.45 / 1.45	1.45 / 1.45	1.45 / 1.45	0.8 / 0.8	
Operating temperature range			+1 °C...+70 °C	+1 °C...+70 °C	+1 °C...+70 °C	+1 °C...+70 °C	
Setting range			+20 °C...+55 °C	+20 °C...+55 °C	+20 °C...+55 °C	+20 °C...+55 °C	
Water inlet temperature			+1 °C...+30 °C	+1 °C...+30 °C	+1 °C...+30 °C	+1 °C...+30 °C	
Water connection	½" connector sleeve		■	■	■	■	
	G ¾" external thread		■	■	■	■	
Permissible operating pressure (p) bar			1 - 10	1 - 10	1 - 10	1 - 10	
Air throughput of fans (unimpeded air flow), Internal circuit 50/60 Hz m³/h			1500 / 1500	1500 / 1500	1500 / 1500	1500 / 1500	
Air throughput of fans (unimpeded air flow), Internal circuit with DC			–	–	–	–	
Weight as delivered kg			39.0	39.0	39.0	42.0	
Accessories							
Condensate hose		1 pc(s).	3301.612	3301.612	3301.612	3301.612	544
Door-operated switch		1 pc(s).	4127.010	4127.010	4127.010	4127.010	1024
Toroidal transformer			–	–	–	–	550
Flow regulator valve			see page	see page	see page	see page	545

Rittal – The System.



Chillers Blue e+

see page 522

Air/water heat exchangers



Accessories for climate control Page 533 **Chillers** Page 519 **Therm software** Page 558

For use in harsh environments and temperature ranges up to +70 °C. With thermostatically controlled magnetic valve.

Colour:
– RAL 7035

Protection category IP to IEC 60 529:

– IP 55

Cooling medium:

– Water (see Internet for specifications)

Supply includes:

– Fully wired ready for connection (plug-in terminal strip)
– Drilling template
– Sealing and assembly parts

Note:

– Use 3-pole miniature circuit-breaker

Approvals:

Available on the Internet

Performance diagrams:

Available on the Internet

Output class 7000 W, wall-mounted

Model No.		Packs of	3216.480	Page
Temperature control	Thermostat-controlled magnetic valve		■	
Total cooling output L35 W10, 500 l/h kW			7	
Total cooling output L35 W20, 500 l/h kW			4.5	
Rated operating voltage V, ~, Hz			400, 3~, 50/60 480, 3~, 60	
Width mm			450	
Height mm			1800	
Depth mm			300	
Rated current max. A			1.4 / 1.6	
Operating temperature range			+1 °C...+70 °C	
Setting range			+20 °C...+55 °C	
Water inlet temperature			+1 °C...+30 °C	
Water connection	½" connector sleeve		■	
	G ¾" external thread		■	
Permissible operating pressure (p) bar			1 - 10	
Air throughput of fans (unimpeded air flow), Internal circuit 50/60 Hz m³/h			4075 / 4840	
Weight as delivered kg			79.0	
Accessories				
Door-operated switch		1 pc(s).	4127.010	1024
Condensate hose		1 pc(s).	3301.612	544
Flow regulator valve			see page	545
Connection set		1 pc(s).	3201.990	545
Cooling medium (ready-mixed)			see page	545

Air/water heat exchangers



Accessories for climate control Page 533 Chillers Page 519 Therm software Page 558 Hygienic Design HD Page 217

Air/water heat exchanger for hygienically sensitive production zones in the food and consumables industry – the optimum addition to the Rittal Hygienic Design range. The cleaning-friendly design reduces the risk of contamination and ensures food safety.

Benefits:

- Easy-to-clean, hygienic design
- A roof tilt of 30° prevents objects from being deposited on it, and allows liquids to run off quickly
- All-round external, replaceable silicone seal prevents the accumulation of dirt between the enclosure and the air/water heat exchanger

Material:

- Enclosure: Stainless steel 1.4301 (AISI 304)

Surface finish:

- Enclosure: Brushed, grain 400, peak-to-valley height < 0.8 µm

Protection category IP to IEC 60 529:

- IP 56/59

Protection category NEMA:

- NEMA 4X

Cooling medium:

- Water (see Internet for specifications)

Supply includes:

- Fully wired ready for connection
- Drilling template
- Sealing and assembly parts

Note:

- To achieve a protection category of IP 66/69 to IEC 60 529, the ingress of leakage air through the condensate discharge opening must be completely prevented

Approvals:

Available on the Internet

Performance diagrams:

Available on the Internet

Climate control

Output class 600 – 1200 W, wall-mounted HD

Model No.	Packs of	3214.700	3215.700	Page
Temperature control	Thermostat-controlled magnetic valve	■	■	
Total cooling output L35 W10, 200 l/h kW		0.6	1	
Total cooling output L35 W10, 400 l/h kW		0.65	1.2	
Power consumption P _{el} 50/60 Hz W		33 / 34	77 / 104	
Rated operating voltage V, ~, Hz		230, 1~, 50/60	230, 1~, 50/60	
Width mm		220	215	
Height mm		526	982	
Depth mm		100	100	
Rated current max. A		0.16 / 0.14	0.38 / 0.47	
Operating temperature range		+1 °C...+70 °C	+1 °C...+70 °C	
Setting range		+20 °C...+60 °C	+20 °C...+60 °C	
Water inlet temperature		+1 °C...+30 °C	+1 °C...+30 °C	
Water connection	G 3/8" external thread	■	■	
Permissible operating pressure (p) bar		1 - 10	1 - 10	
Air throughput of fans (unimpeded air flow), Internal circuit 50/60 Hz m³/h		280 / 310	680 / 735	
Weight as delivered kg		6.0	14.0	
Accessories				
Toroidal transformer		see page	see page	550
Cooling medium (ready-mixed)		see page	see page	545

Air/water heat exchangers



Accessories for climate control Page 533 Chillers Page 519 Air routing Page 540

For use in harsh environments and temperature ranges up to +70 °C. The air/water heat exchanger is assembled on the roof of the enclosure using flexible water connection options.

Colour:
– RAL 7035

Protection category IP to IEC 60 529:
– IP 55

Cooling medium:
– Water (see Internet for specifications)

Supply includes:
– Fully wired ready for connection (plug-in terminal strip)
– Drilling template
– Sealing mat
– Assembly parts

Approvals:
Available on the Internet

Performance diagrams:
Available on the Internet

Output class 1875 – 3000 W, roof-mounted

Model No.		Packs of	3209.504	3209.100	3209.500	3210.504	Page
Design	Water-carrying parts, copper/brass (Cu/CuZn)		–	■	■	–	
	Water-carrying parts, stainless steel (1.4571)		■	–	–	■	
Temperature control	Basic controller (factory setting +35 °C)		–	■	–	–	
	e-Comfort controller (factory setting +35 °C)		■	–	■	■	
Total cooling output L35 W10, 400 l/h kW			1.87	2.5	2.5	3	
Power consumption P _{el} 50/60 Hz W			95 / 110	95 / 110	95 / 110	100 / 120	
Rated operating voltage V, ~, Hz			230, 1~, 50/60	230, 1~, 50/60	230, 1~, 50/60	230, 1~, 50/60	
Width mm			597	597	597	597	
Height mm			417	417	417	417	
Depth mm			475	475	475	475	
Rated current max. A			0.4 / 0.48	0.4 / 0.48	0.4 / 0.48	0.44 / 0.5	
Operating temperature range			+1 °C...+70 °C	+1 °C...+70 °C	+1 °C...+70 °C	+1 °C...+70 °C	
Setting range			+20 °C...+55 °C	+20 °C...+55 °C	+20 °C...+55 °C	+20 °C...+55 °C	
Water inlet temperature			+1 °C...+30 °C	+1 °C...+30 °C	+1 °C...+30 °C	+1 °C...+30 °C	
Water connection	½" connector sleeve		■	■	■	■	
	G ¾" external thread		■	■	■	■	
Permissible operating pressure (p) bar			1 - 10	1 - 10	1 - 10	1 - 10	
Air throughput of fans (unimpeded air flow), Internal circuit 50/60 Hz m³/h			925 / 1030	925 / 1030	925 / 1030	815 / 925	
Weight as delivered kg			23.5	23.5	23.5	25.5	
Accessories							
Door-operated switch		1 pc(s).	4127.010	4127.010	4127.010	4127.010	1024
Master/slave cable		1 pc(s).	3124.100	–	3124.100	3124.100	550
Air duct system		1 pc(s).	3286.870	3286.870	3286.870	3286.870	540
Stoppers		2 pc(s).	3286.880	3286.880	3286.880	3286.880	542
Condensate hose		1 pc(s).	3301.612	3301.612	3301.612	3301.612	544
Cooling medium (ready-mixed)			see page	see page	see page	see page	545

Air/water heat exchangers

Output class 4000 W, roof-mounted

Model No.		Packs of	3210.100	3210.500	3210.540	Page
Design	Water-carrying parts, copper/brass (Cu/CuZn)		■	■	■	
Temperature control	Basic controller (factory setting +35 °C)		■	–	–	
	e-Comfort controller (factory setting +35 °C)		–	■	■	
Total cooling output L35 W10, 400 l/h kW			4	4	4	
Power consumption P _{el} 50/60 Hz W			100 / 120	100 / 120	102 / 125	
Rated operating voltage V, ~, Hz			230, 1~, 50/60	230, 1~, 50/60	400, 2~, 50/60	
Width mm			597	597	597	
Height mm			417	417	417	
Depth mm			475	475	475	
Rated current max. A			0.44 / 0.5	0.44 / 0.5	0.25 / 0.3	
Operating temperature range			+1 °C...+70 °C	+1 °C...+70 °C	+1 °C...+70 °C	
Setting range			+20 °C...+55 °C	+20 °C...+55 °C	+20 °C...+55 °C	
Water inlet temperature			+1 °C...+30 °C	+1 °C...+30 °C	+1 °C...+30 °C	
Water connection	½" connector sleeve		■	■	■	
	G ¾" external thread		■	■	■	
Permissible operating pressure (p) bar			1 - 10	1 - 10	1 - 10	
Air throughput of fans (unimpeded air flow), Internal circuit 50/60 Hz m³/h			815 / 925	815 / 925	815 / 925	
Weight as delivered kg			25.5	25.5	29.5	
Accessories						
Door-operated switch		1 pc(s).	4127.010	4127.010	4127.010	1024
Master/slave cable		1 pc(s).	–	3124.100	3124.100	550
Air duct system		1 pc(s).	3286.870	3286.870	3286.870	540
Stoppers		2 pc(s).	3286.880	3286.880	3286.880	542
Condensate hose		1 pc(s).	3301.612	3301.612	3301.612	544
Cooling medium (ready-mixed)			see page	see page	see page	545



Liquid Cooling Package



Accessories for climate control Page 533 **Chillers** Page 519 **Therm software** Page 558

Air/water heat exchanger in the bayed enclosure system VX25. To fit 600 or 800 mm deep and 2,000 mm high VX25 enclosures. Air outlet either with 5 kW on each side or 10 kW on one side only. Flexible options for water connection on the top or bottom of the unit.

Temperature control:
– e-Comfort controller (factory setting +35 °C)

Colour:
– RAL 7035

Protection category IP to IEC 60 529:
– IP 55

Cooling medium:
– Water (see Internet for specifications)

Supply includes:
– Cooling unit ready for connection, wired to terminal strip
– Front door with display
– Rear panel
– Multilingual documentation

Note:
– Bayable by screw-fastening at the sides

Approvals:
Available on the Internet

Performance diagrams:
Available on the Internet

Output class 10000 W, LCP rack industry

Model No.	Packs of	3378.300	3378.380	Page
Design	Water-carrying parts, copper/brass (Cu/CuZn)	■	■	
Total cooling output L35 W10, 2000 l/h kW		9.5	9.5	
Power consumption P _{el} 50/60 Hz W		350 / 350	350 / 350	
Rated operating voltage V, ~, Hz		230, 1~, 50/60	230, 1~, 50/60	
Width mm		300	300	
Height mm		2000	2000	
Depth mm		600	800	
Rated current max. A		2.65 / 2.62	2.65 / 2.62	
Operating temperature range		+5 °C...+70 °C	+5 °C...+70 °C	
Setting range		+20 °C...+55 °C	+20 °C...+55 °C	
Water inlet temperature		+7 °C...+30 °C	+7 °C...+30 °C	
Water connection	G ¾" internal thread	■	■	
Permissible operating pressure (p) bar		1 - 6	1 - 6	
Air throughput of fans (unimpeded air flow), Internal circuit 50/60 Hz m³/h		1950 / 1950	1950 / 1950	
Weight as delivered kg		106.0	115.0	

Accessories				
Base/plinth corner piece with base/plinth trim panels, front and rear, 100 mm	2 pc(s).	8640.000	8640.000	881
Base/plinth trim panels, sides, 100 mm	2 pc(s).	8640.033	8640.034	882
Base/plinth corner piece with base/plinth trim panels, front and rear, 200 mm	2 pc(s).	8640.020	8640.020	881
Base/plinth trim panels, sides, 200 mm	2 pc(s).	8640.043	8640.044	882
Baying connector, external	6 pc(s).	8617.502	8617.502	912
Side panel, screw-fastened, sheet steel	2 pc(s).	8106.245	8108.245	901
Condensate hose	1 pc(s).	3301.612	3301.612	544
EC speed control	1 pc(s).	3235.440	3235.440	548
Comfort handle VX	1 pc(s).	8618.250	8618.250	937
Master/slave cable	1 pc(s).	3124.100	3124.100	550
Cooling medium (ready-mixed)		see page	see page	545



Accessories for climate control Page 533 Chiller configurator Page 558

Design:

- Compact, modular layout of the refrigeration components
- Nano-coated condenser
- Pump to convey the medium

Benefits:

- Precise temperature control, based on microprocessor technology
- Collective fault signal with floating contact
- One version for two frequencies = international compatibility

Temperature control:

- Microcontroller control (factory setting +20 °C)

Colour:

- RAL 7035

Protection category IP to IEC 60 529:

- IP 44 (electronics)

Supply includes:

- Complete unit ready for connection
- Multilingual documentation including functional diagram and wiring plans

Characteristic curves of pump:

Available on the Internet

Approvals:

Available on the Internet

Output class 1000 – 1500 W

Model No.	Packs of	3318.610	3319.610	Page
Total cooling output at $T_w = 10\text{ °C}/T_u = 32\text{ °C}$ kW		0.8 / 0.9	1.2 / 1.3	
Total cooling output at $T_w = 18\text{ °C}/T_u = 32\text{ °C}$ kW		1 / 1.1	1.5 / 1.7	
Power consumption P_{el} 50/60 Hz kW		0.69 / 1.07	0.86 / 0.99	
Rated operating voltage V, -, Hz		230, 1-, 50/60	230, 1-, 50/60	
Width mm		600	600	
Height mm		400	400	
Depth mm		455	455	
Rated current max. A		5.1 / 5.6	5.7 / 5.6	
Operating temperature range		+10 °C...+43 °C	+10 °C...+43 °C	
Refrigerant g		R134a, 975	R134a, 975	
Water connection	G ½" internal thread	■	■	
Pump pressure bar		2.5	2.5	
Volumetric flow (cooling medium) l/min		4 / 6	4 / 6	
Air throughput of fans (unimpeded air flow), 50/60 Hz m³/h		900 / 900	900 / 900	
Temperature hysteresis		± 2 K	± 2 K	
Temperature of liquid		+10 °C...+30 °C	+10 °C...+30 °C	
Water circuit version		hermetically open	hermetically open	
Tank		PP plastic	PP plastic	
Tank capacity l		2.5	2.5	
Weight as delivered kg		48.0	51.0	
Also required				
Cooling medium (ready-mixed)		see page	see page	545
Accessories				
Metal filter	1 pc(s).	3286.510	3286.510	534

Blue e+ chillers with the principle



Forward-looking climate control

- Active cooling circuit with speed-controlled components for demand-based cooling
- High control accuracy thanks to DC inverter technology with two regulating modes
- Excellent operational reliability thanks to integrated flow sensor, overflow valve and electronic fill level monitoring
- Temperature limits from -5 °C to +50 °C
- 55% less refrigerant thanks to the use of microchannel technology
- Energy savings of up to 70%

Intelligent networking

- In conjunction with the IoT interface, all Blue e+ chillers can now be networked and digitalised

The benefits for you:

- Continuous monitoring of temperature accuracy
- Avoidance of downtime costs and consequential damage
- Temperature records and energy efficiency analyses
- Enhanced process reliability

Easier to operate

- Fast unit analysis using RiDiag III software via the USB port
- Fast parameterisation, data reading and plain-text system messages via the intelligent, multilingual, industry-grade display (21 languages pre-installed)

Maximum flexibility with assembly and siting

- Simple plug & play assembly
- Identical footprint for all performance classes
- Eyebolts for easier transportation
- Service-friendly thanks to optimum accessibility of all components
- Easy replacement of components

For global use

- One device for all voltages and networks:
 - 380 to 415 V, 3~, 50 Hz
 - 440 to 480 V, 3~, 60 Hz
- International approvals: cULus Listed, EAC, CB-Report
- Pre-configured option packages



Climate control

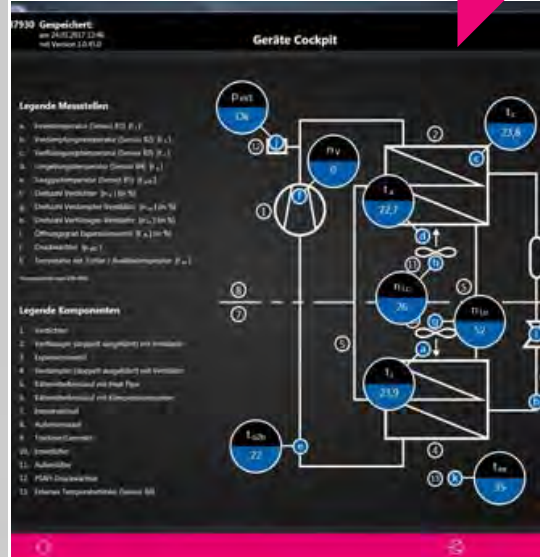

Chillers Blue e+



Accessories for climate control Page 533 Chiller configurator Page 558 IoT interface Page 554

Benefits:

- Blue e+ chillers ensure centralised and efficient cooling of liquid media with a high level of temperature accuracy and innovative DC inverter technology
- Suitable for international use thanks to its unique multi-voltage capability (without rewiring) and high operating limits
- Maximum reliability thanks to integral overflow valve and monitoring sensors
- Intuitive operation due to touch display and intelligent interfaces
- Compact and modular layout ensures minimum footprint
- Pumps with highly efficient IE3 motors

Temperature control:

- e+ controller (factory setting +20 °C)

Colour:

- Textured RAL 7035

Protection category IP to IEC 60 529:

- IP 24

Supply includes:

- Complete unit ready for connection (plug-in terminal strip)
- Multilingual documentation

Optional:

- For remote monitoring and networking of cooling units and chillers in the Blue e+ generation, please use the IoT interface (Model No. 3124.300). Increase machine availability and process reliability with remote monitoring of device data, statuses and system messages.

Approvals:

Available on the Internet

Performance diagrams:

Available on the Internet

Output class 2500 – 5500 W

Model No.	Packs of	3320.200	3334.300	3334.400	Page
Total cooling output at $T_w = 18\text{ °C}/T_u = 35\text{ °C}$ to DIN EN 14511 kW					
		2.5 / 2.4	4 / 3.9	5.5 / 5.4	
Power consumption P_{el} 50/60 Hz kW		1.38 / 1.57	2.49 / 2.72	2.49 / 2.72	
Rated operating voltage V, ~, Hz		380 - 415, 3~, 50 440 - 480, 3~, 60	380 - 415, 3~, 50 440 - 480, 3~, 60	380 - 415, 3~, 50 440 - 480, 3~, 60	
Width mm		450	450	450	
Height mm		820	820	1000	
Depth mm		710	710	710	
Rated current max. A		2.17 / 1.95	3.95 / 3.47	3.95 / 3.47	
Operating temperature range		-5 °C...+50 °C	-5 °C...+50 °C	-5 °C...+50 °C	
Refrigerant g		R134a, 460	R134a, 760	R134a, 930	
Water connection	¾" internal thread	■	■	■	
Pump pressure bar		2.4	2.9	2.9	
Volumetric flow (cooling medium) l/min		7 / 25	15 / 30	15 / 30	
Temperature hysteresis		± 0.5 K	± 0.5 K	± 0.5 K	
Temperature of liquid		+5 °C...+35 °C	+5 °C...+35 °C	+5 °C...+35 °C	
Water circuit version		hermetically open	hermetically open	hermetically open	
Tank		PE plastic	PE plastic	PE plastic	
Tank capacity l		12	12	12	
Weight as delivered kg		84.0	90.0	96.0	
Also required					
Cooling medium (ready-mixed)		see page	see page	see page	545
Accessories					
Filter mat for cooling units, air/air heat exchangers and chillers	3 pc(s).	3285.920	3285.920	3285.900	533
Filter mat for Blue e+ chillers (inverter housings)	3 pc(s).	3285.940	3285.940	3285.940	533
Metal filter	1 pc(s).	3285.930	3285.930	3285.910	534
IoT interface	1 pc(s).	3124.300	3124.300	3124.300	554
RiDiag	1 pc(s).	3159.300	3159.300	3159.300	559
Temperature sensor	1 pc(s).	3124.400	3124.400	3124.400	549
Cross member	2 pc(s).	8601.680	8601.680	8601.680	891
Levelling feet	4 pc(s).	4612.000	4612.000	4612.000	892
Twin castors	1 pc(s).	6148.000	6148.000	6148.000	893
Flow regulator valve		see page	see page	see page	545

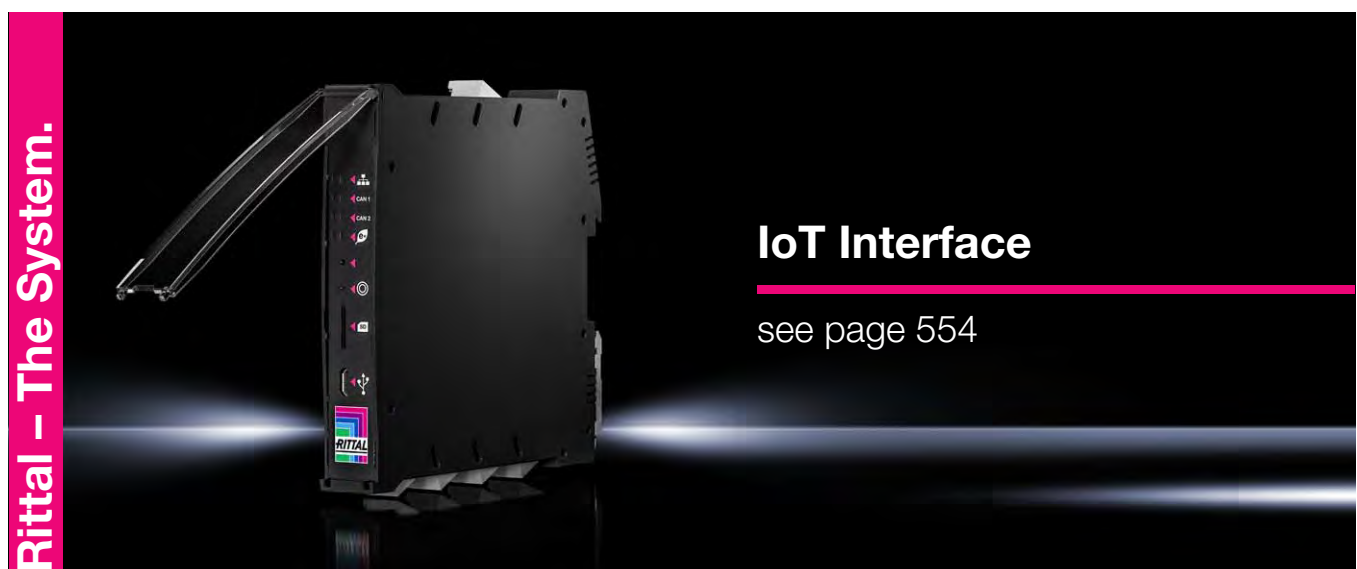

Blue e chillers

Targeted cooling output with exceptional efficiency



Simple user prompting

- Fast parameterisation, data reading and plain-text system messages via the intelligent, multilingual, industry-grade touch display
- Prioritised error messages with three escalation levels (warning, error, maintenance)

Targeted climate control

- Central activation of the fan and compressor via a digital controller
- Hysteresis with precision controller (HGBP) ± 0.25 K

Sustainably eco-friendly

- 40% less refrigerant thanks to the use of microchannel technology
- No galvanic corrosion, as the micro-channel heat exchanger is made from 100% aluminium

Simple assembly

- Plug & play
- Fully wired ready for connection
- Service-friendly thanks to optimum accessibility of all components

Integral safety functions

- Integral overflow valves
- Fill level monitoring
- Flow monitor

Pre-configured options (also available as add-on packages)

- For shorter delivery times and a simplified ordering process

- 1 Increased-output pump (4 and 6 bar)
- 2 Pumps: Multi-circuit systems
- 3 Outdoor (up to -20 °C)
- 4 Heater
- 5 Industrial connector
- 6 Precision controller (HGBP)
- 7 Special spray finish
- 8 Water-cooled condenser
- 9 Laser application

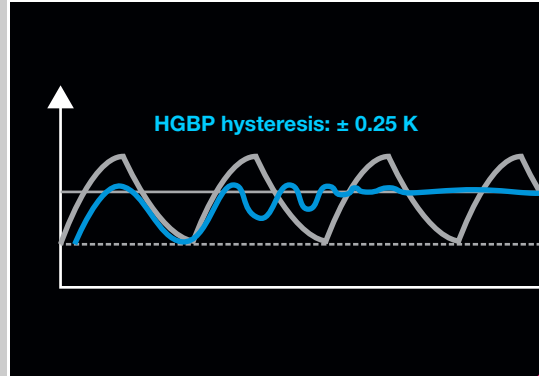

Chillers Blue e



Accessories for climate control Page 533 Cooling medium Page 545

Design:

- Robust industrial standard
- Variable air routing is possible via the l/h or r/h side panel
- Floating contact for collective fault signal

Benefits:

- Reduced volume of refrigerant, thanks to microchannel technology
- Touch display for simplified user guidance
- Intelligent interfaces
- Integral safety functions
- Pre-configured options

Colour:

- Enclosure: RAL 7035
- Base/plinth: RAL 7016

Protection category IP to IEC 60 529:

- IP 44 (electrics)

Supply includes:

- Chiller wired ready for connection
- Multilingual documentation including functional diagram and wiring plans

Approvals:

- Available on the Internet

Output class 11000 – 15000 W

Model No.	Packs of	3336.400	3336.405	3336.410	3336.415	Page
Total cooling output at $T_w = 10\text{ °C}/T_u = 32\text{ °C}$ kW		10.2 / 11.7	10.2 / 11.7	12.2 / 12.3	12.2 / 12.3	
Total cooling output at $T_w = 18\text{ °C}/T_u = 32\text{ °C}$ kW		11.8 / 13.2	11.8 / 13.2	14.3 / 14.8	14.3 / 14.8	
Power consumption P_{el} 50/60 Hz kW		6.3 / 8.8	6.3 / 8.8	7.02 / 8.75	7.7 / 9.9	
Rated operating voltage V, ~, Hz		400, 3~, 50 460, 3~, 60	400, 3~, 50 460, 3~, 60	400, 3~, 50 460, 3~, 60	400, 3~, 50 460, 3~, 60	
Width mm		660	660	660	660	
Height mm		1265	1265	1265	1265	
Depth mm		1315	1315	1315	1315	
Rated current max. A		10.2 / 11.3	11.1 / 13.1	12.9 / 12.9	13.8 / 14.65	
Performance-enhanced pump		-	■	-	■	
Control voltage 24 V DC		-	■	-	■	
Precision controller		-	■	-	■	
Operating temperature range		+10 °C...+43 °C	+10 °C...+43 °C	+10 °C...+43 °C	+10 °C...+43 °C	
Refrigerant g		R410a, 1350	R410a, 1350	R410a, 1350	R410a, 1350	
Water connection	R 1" internal thread	■	■	■	■	
Pump pressure bar		2 / 2	5 / 7	2 / 2	5 / 7	
Volumetric flow (cooling medium) l/min		30 / 55	30 / 55	35 / 55	35 / 55	
Air throughput of fans (unimpeded air flow), 50/60 Hz m ³ /h		6000 / 7200	6000 / 7200	6000 / 7200	6000 / 7200	
Temperature hysteresis		± 2 K	± 0.25 K	± 2 K	± 0.25 K	
Temperature of liquid		+10 °C...+25 °C	+10 °C...+25 °C	+10 °C...+25 °C	+10 °C...+25 °C	
Tank		PE plastic	PE plastic	PE plastic	PE plastic	
Tank capacity l		49	49	49	49	
Weight as delivered kg		247.0	247.0	253.0	253.0	
Accessories						
Cooling medium (ready-mixed)		see page	see page	see page	see page	545
Metal filter	2 pc(s).	3286.560	3286.560	3286.560	3286.560	534

Output class 20000 – 25000 W

Model No.	Packs of	3336.430	3336.435	3336.450	3336.455	Page
Total cooling output at $T_w = 10\text{ °C}/T_u = 32\text{ °C}$ kW		16.3 / 19.2	16.3 / 19.2	19.9 / 22.9	19.9 / 22.9	
Total cooling output at $T_w = 18\text{ °C}/T_u = 32\text{ °C}$ kW		19.3 / 22	19.3 / 22	24.4 / 26.3	24.4 / 26.3	
Power consumption P_{el} 50/60 Hz kW		8.5 / 10.9	8.5 / 10.9	10.6 / 13.3	11.3 / 14.4	
Rated operating voltage V, ~, Hz		400, 3~, 50 460, 3~, 60	400, 3~, 50 460, 3~, 60	400, 3~, 50 460, 3~, 60	400, 3~, 50 460, 3~, 60	
Width mm		760	760	760	760	
Height mm		1265	1265	1265	1265	
Depth mm		1515	1515	1515	1515	
Rated current max. A		19 / 15.9	19.9 / 17.2	21.7 / 22.4	22.6 / 24.1	
Performance-enhanced pump		–	■	–	■	
Control voltage 24 V DC		–	■	–	■	
Precision controller		–	■	–	■	
Operating temperature range		+10 °C...+43 °C	+10 °C...+43 °C	+10 °C...+43 °C	+10 °C...+43 °C	
Refrigerant g		R410a, 1450	R410a, 1450	R410a, 1450	R410a, 1450	
Water connection	R 1¼" internal thread	■	■	■	■	
Pump pressure bar		2 / 2	4.75 / 6.75	2 / 2	4.5 / 6.7	
Volumetric flow (cooling medium) l/min		45 / 75	45 / 75	55 / 75	55 / 75	
Air throughput of fans (unimpeded air flow), 50/60 Hz m³/h		12000 / 14500	12000 / 14500	12000 / 14500	12000 / 14500	
Temperature hysteresis		± 2 K	± 0.25 K	± 2 K	± 0.25 K	
Temperature of liquid		+10 °C...+25 °C	+10 °C...+25 °C	+10 °C...+25 °C	+10 °C...+25 °C	
Tank		PE plastic	PE plastic	PE plastic	PE plastic	
Tank capacity l		78	78	78	78	
Weight as delivered kg		310.0	310.0	326.0	326.0	
Accessories						
Cooling medium (ready-mixed)		see page	see page	see page	see page	545
Metal filter	2 pc(s).	3286.570	3286.570	3286.570	3286.570	534

Rittal – The System.

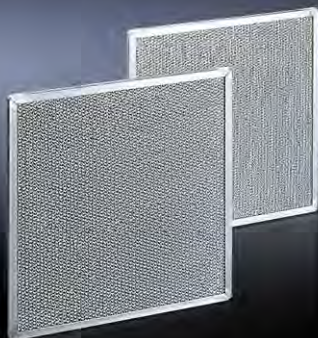

Metal filters

see page 534

VX25 TopTherm chillers



Accessories for climate control Page 533 Chiller configurator Page 558

TopTherm chillers in a VX25 enclosure with a small footprint are perfect for integrating into an enclosure suite. Their dual-frequency compatibility makes them extremely flexible. The microchannel technology reduces the volume of refrigerant required.

Benefits:

- Convenient servicing
- High reliability thanks to icing protection
- One version for two frequencies = international compatibility
- Reduced volume of refrigerant, thanks to microchannel technology
- Bayable by screw-fastening at the sides
- Integral safety functions

Temperature control:

- e-controller (factory setting +18 °C)

Colour:

- RAL 7035

Protection category IP to IEC 60 529:

- IP 44 (electrics)

Supply includes:

- Fully wired unit ready for connection with side panels and door

Note:

- Regular leak tests are not prescribed by law.

Characteristic curves of pump:

Available on the Internet

Approvals:

Available on the Internet

Output class 8000 – 12000 W

Model No.	Packs of	3335.920	3335.930	3335.940	Page
Total cooling output at T_w = 18 °C/T_u = 32 °C kW		8 / 8.6	8 / 8.6	12 / 13.1	
Power consumption P _{el} 50/60 Hz kW		4.34 / 5.22	4.65 / 5.71	6.35 / 7.31	
Rated operating voltage V, ~, Hz		400, 3~, 50 460, 3~, 60	400, 3~, 50 460, 3~, 60	400, 3~, 50 460, 3~, 60	
Width mm		805	805	805	
Height mm		1700	2100	2140	
Depth mm		605	605	605	
Rated current max. A		8.4 / 7.5	9 / 8.3	9.9 / 10.8	
Operating temperature range		+10 °C...+43 °C	+10 °C...+43 °C	+10 °C...+43 °C	
Refrigerant g		R410a, 1200	R410a, 1200	R410a, 1400	
Water connection	G 1" internal thread	■	■	■	
Pump pressure bar		2.5	2.5	2.5	
Volumetric flow (cooling medium) l/min		30 / 45	30 / 45	35 / 55	
Temperature hysteresis		± 2 K	± 2 K	± 2 K	
Temperature of liquid		+10 °C...+25 °C	+10 °C...+25 °C	+10 °C...+25 °C	
Tank capacity l		75	75	75	
Weight as delivered kg		242.0	248.0	282.0	
Accessories					
Metal filter	1 pc(s).	3286.650	3286.630	3286.630	
Cooling medium (ready-mixed)		see page	see page	see page	545
Flow regulator valve		see page	see page	see page	545
Comfort handle VX	1 pc(s).	8618.250	8618.250	8618.250	937
Twin castors	1 pc(s).	7495.000	7495.000	7495.000	893
Base/plinth corner piece with base/plinth trim panels, front and rear, 100 mm	2 pc(s).	8640.003	8640.003	8640.003	881
Base/plinth trim panels, sides, 100 mm	2 pc(s).	8640.033	8640.033	8640.033	882
Base/plinth corner piece with base/plinth trim panels, front and rear, 200 mm	2 pc(s).	8640.023	8640.023	8640.023	881
Base/plinth trim panels, sides, 200 mm	2 pc(s).	8640.043	8640.043	8640.043	882

VX25 TopTherm chillers

Output class 16000 – 25000 W

Model No.	Packs of	3335.950	3335.960	3335.970	Page
Total cooling output at $T_w = 18\text{ °C}/T_u = 32\text{ °C}$ kW					
		16 / 17.6	20 / 21.8	25 / 27.6	
Power consumption P_{el} 50/60 Hz kW		7.05 / 8.71	9.21 / 11.75	11.31 / 14.12	
Rated operating voltage V_n , ~, Hz		400, 3~, 50 460, 3~, 60	400, 3~, 50 460, 3~, 60	400, 3~, 50 460, 3~, 60	
Width mm		805	1205	1205	
Height mm		2140	2140	2140	
Depth mm		605	605	605	
Rated current max. A		12.6 / 12.3	20.2 / 17.3	22.9 / 23.8	
Operating temperature range		+10 °C...+43 °C	+10 °C...+43 °C	+10 °C...+43 °C	
Refrigerant g		R410a, 1400	R410a, 1550	R410a, 1700	
Water connection	G 1" internal thread	■	■	■	
Pump pressure bar		2.5	2.5	2.5	
Volumetric flow (cooling medium) l/min		35 / 65	45 / 75	50 / 85	
Temperature hysteresis		± 2 K	± 2 K	± 2 K	
Temperature of liquid		+10 °C...+25 °C	+10 °C...+25 °C	+10 °C...+25 °C	
Tank capacity l		75	150	150	
Weight as delivered kg		282.0	360.0	374.0	
Accessories					
Metal filter	1 pc(s).	3286.630	3286.640	3286.640	
Cooling medium (ready-mixed)		see page	see page	see page	545
Flow regulator valve		see page	see page	see page	545
Comfort handle VX	1 pc(s).	8618.250	8618.250	8618.250	937
Twin castors	1 pc(s).	7495.000	7495.000	7495.000	893
Base/plinth corner piece with base/plinth trim panels, front and rear, 100 mm	2 pc(s).	8640.003	8640.007	8640.007	881
Base/plinth trim panels, sides, 100 mm	2 pc(s).	8640.033	8640.033	8640.033	882
Base/plinth corner piece with base/plinth trim panels, front and rear, 200 mm	2 pc(s).	8640.023	8640.025	8640.025	881
Base/plinth trim panels, sides, 200 mm	2 pc(s).	8640.043	8640.043	8640.043	882

Rittal – The System.



Chiller configurator

see page 558

Enclosure heaters



Accessories for climate control Page 533 Therm software Page 558

Enclosure heaters to regulate relative humidity, prevent temperatures from dropping below the dew point and stop condensation forming inside the enclosure. This prevents consequential damage associated with corrosion or electrical short circuits.

Material:

- Aluminium, anodised

Protection category IP to IEC 60 529:

- IP 20

Protection class:

- II (all-insulated)

Supply includes:

- PTC heater
- Quick-connection terminal
- Assembly parts

Note:

- A thermostat is recommended for precise temperature control inside the enclosure
- In order to prevent condensation on assemblies, a hygrostat is recommended to regulate heating
- In larger enclosures, even heat distribution is best achieved by installing several low-output heaters

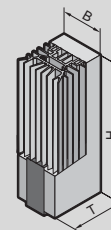

Approvals:

Available on the Internet

Continuous thermal output 10 – 150 W, without fan

Model No.	Packs of	3105.310	3105.320	3105.330	3105.340	3105.350	3105.360	3105.370	Page
Width (B) mm		45	45	64	64	64	90	90	
Height (H) mm		120	120	155	155	230	165	180	
Depth (T) mm		46	46	56	56	56	75	75	
Continuous thermal output at T_u = 10 °C W		8 - 10	18 - 20	23 - 30	49 - 50	63 - 75	86 - 100	130 - 150	
Rated operating voltage V, ~, Hz		110 - 240, 1~, 50/60	110 - 240, 1~, 50/60	110 - 240, 1~, 50/60	110 - 240, 1~, 50/60	110 - 240, 1~, 50/60	110 - 240, 1~, 50/60	110 - 240, 1~, 50/60	

Accessories

Thermostat	1 pc(s).	3110.000	3110.000	3110.000	3110.000	3110.000	3110.000	3110.000	547
Hygrostat	1 pc(s).	3118.000	3118.000	3118.000	3118.000	3118.000	3118.000	3118.000	547
Digital enclosure internal temperature display and thermostat	1 pc(s).	3114.200	3114.200	3114.200	3114.200	3114.200	3114.200	3114.200	546
Bottom-mounted adaptor	1 pc(s).	3110.200	3110.200	3110.200	3110.200	3110.200	3110.200	3110.200	548



Accessories for climate control Page 533 Therm software Page 558

Enclosure heaters to regulate relative humidity, prevent temperatures from dropping below the dew point and stop condensation forming inside the enclosure. This prevents consequential damage associated with corrosion or electrical short circuits.

Material:

- Plastic

Protection category IP to IEC 60 529:

- IP 20

Protection class:

- II (all-insulated)

Supply includes:

- PTC heater with fan
- Assembly parts

Note:

- A thermostat is recommended for precise temperature control inside the enclosure
- In order to prevent condensation on assemblies, a hygrostat is recommended to regulate heating
- In larger enclosures, even heat distribution is best achieved by installing several low-output heaters

Approvals:

Available on the Internet

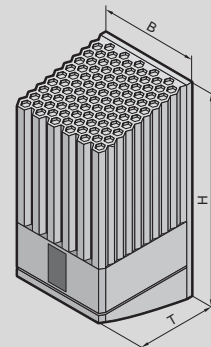

Climate control

Continuous thermal output 235 – 800 W, with fan

Model No.	Packs of	3105.410	3105.380	3105.420	3105.390	3105.430	3105.400	Page
Width (B) mm		103	103	103	103	103	103	
Height (H) mm		200	200	200	200	200	200	
Depth (T) mm		103	103	103	103	103	103	
Continuous thermal output at T_u = 10 °C 50/60 Hz W		235 / 250	250 / 265	355 / 400	400 / 415	710 / 800	800 / 870	
Rated operating voltage V, ~, Hz		115, 1~, 50/60	230, 1~, 50/60	115, 1~, 50/60	230, 1~, 50/60	115, 1~, 50/60	230, 1~, 50/60	
Accessories								
Thermostat	1 pc(s).	3110.000	3110.000	3110.000	3110.000	3110.000	3110.000	547
Hygrostat	1 pc(s).	3118.000	3118.000	3118.000	3118.000	3118.000	3118.000	547
Digital enclosure internal temperature display and thermostat	1 pc(s).	3114.200	3114.200	3114.200	3114.200	3114.200	3114.200	546

Innovative climate control accessories

Perfectly coordinated components customised to your requirements, from page 533



Accessories for climate control

Filter technology

Filter mat

for tangential fans

Made of chopped-fibre mat with a progressive structure. Temperature-resistant to 100 °C, self-extinguishing category F1 to DIN 53 438. Dust-laden air side: Open structure. Clean-air side: Closed structure. Reliable filtering of virtually all types of dust from a particle size of 10 µm.

Material:

- Chemical fibres

For tangential fans/front outlet grilles 2 U

To fit Model No.	W x H x D mm	Packs of	Model No.
3144.000/ 3145.000/ 3176.000	425 x 85 x 8	5 pc(s).	3177.000



Filter mat

for cooling units, air/air heat exchangers and chillers

Rittal cooling units are low-maintenance and are supplied without filter mats. Filter mats may be used for extreme conditions.

Benefits:

- Temperature-resistant from -40 °C...+80 °C

Material:

- Open-celled polyurethane foamed plastic



To fit Model No.	for cooling units	for air/air heat exchangers	for chillers	W x H x D mm	Packs of	Model No.
3320.200/3334.300	–	–	■	320 x 599 x 8	3 pc(s).	3285.920
3302.300/3303.310	■	–	–	190 x 95 x 10	3 pc(s).	3286.110
3273.../3382.../3383.../ 3384.../3385.../3359.../ 3301.800	■	–	–	530 x 255 x 10	3 pc(s).	3286.500
3386.../3387....	■	–	–	720 x 300 x 10	3 pc(s).	3286.600
3185.830/3185.530	■	–	–	360 x 297 x 10	3 pc(s).	3285.800
3186.930/3187.930/ 3188.940/3189.940/ 3186.630/3187.630/ 3188.640/3189.640/ 3334.400	■	–	■	390 x 397 x 10	3 pc(s).	3285.900
3302.1xx/3302.200/ 3303.xx0/3361.../ 3126.100/3126.115	■	■	–	265 x 200 x 10	3 pc(s).	3286.300
3304.xx0/3305.xx0/ 3328.xx0/3329.xx0/ 3332.../3366.../ 3127.100/3127.115/ 3128.100/3128.115/ 3129.100/3129.115/ 3130.100/3130.115	■	■	–	344 x 268 x 10	3 pc(s).	3286.400

Filter mat

for Blue e+ chillers (inverter housings)

Flat-pleated filter for Blue e+ chillers made from polyester with all-round frame and V brackets on the end face.

Material:

- Polyester

Filter class to DIN EN 779:

- G3

For Blue e+ chillers

To fit Model No.	W x H x D mm	Packs of	Model No.
3320.200/ 3334.300/ 3334.400	131 x 113 x 13	3 pc(s).	3285.940



Accessories for climate control

Filter technology



Metal filter

Particularly when cooling units are used in dusty and oily environments, it is advisable to use washable metal filters. If air or steam condenses on the metal surfaces, any particles present will adhere to the metal, and can easily be washed out with water or grease-dissolving detergents.

Material:

- Aluminium

To fit Model No.	for cooling units	for air/air heat exchangers	for chillers	for climate control door/section door	W x H x D mm	Packs of	Model No.
3185.830/3185.530	■	–	–	–	320 x 280 x 10	1 pc(s).	3285.810
3320.200/3334.300	–	–	■	–	295 x 599 x 15	1 pc(s).	3285.930
3336.400/3336.405/ 3336.410/3336.415	–	–	■	–	700 x 724 x 20	2 pc(s).	3286.560
3336.430/3336.435/ 3336.450/3336.455	–	–	■	–	945 x 765 x 20	2 pc(s).	3286.570
3186.930/3187.930/ 3188.940/3189.940/ 3186.630/3187.630/ 3188.640/3189.640/ 3334.400	■	–	■	–	380 x 358 x 10	1 pc(s).	3285.910
3300.040/3300.050/ 3300.060/3300.070/ 3300.080/3300.090/ 3300.110/3300.120/ 3201.800/3201.810/ 3201.820/3201.830/ 3201.840/3201.850	–	–	–	■	425 x 78 x 10	1 pc(s).	3284.210
3302.300/3302.310	■	–	–	–	190 x 95 x 10	1 pc(s).	3286.120
3302.1xx/3302.200/ 3303.xx0/3361..../ 3126.100/3126.115	■	■	–	–	265 x 200 x 10	1 pc(s).	3286.310
3304.xx0/3305.xx0/ 3328.xx0/3329.xx0/ 3332..../3366.../ 3127.100/3127.115/ 3128.100/3128.115/ 3129.100/3129.115/ 3130.100/3130.115/ 3360.100	■	■	■	–	344 x 268 x 10	1 pc(s).	3286.410
3273..../3382..../3383..../ 3384..../3385..../3359..../ 3318.600/3318.610/ 3319.600/3319.610/ 3334.660	■	–	■	–	530 x 255 x 10	1 pc(s).	3286.510
3320.600/3334.600	–	–	■	–	500 x 558 x 8	1 pc(s).	3286.520
3386..../3387....	■	–	–	–	720 x 300 x 10	1 pc(s).	3286.610
3335.840/3335.850/ 3335.880	–	–	■	–	595 x 1030 x 20	1 pc(s).	3286.530
3335.860/3335.870/ 3335.890	–	–	■	–	1000 x 1035 x 20	1 pc(s).	3286.540
3335.790/3335.830	–	–	■	–	595 x 780 x 20	1 pc(s).	3286.550

Spare filter mat

Made of chopped-fibre mat with a progressive structure. Temperature-resistant to 100 °C, self-extinguishing category F1 to DIN 53 438. Dust-laden air side: Open structure. Clean-air side: Closed structure. Reliable filtering of virtually all types of dust from a particle size of 10 µm.

Note:

- Performance data, protection category and device approvals are only guaranteed when used in conjunction with original Rittal filter mats.

For roof-mounted fan

To fit Model No.	Material	W x H x D mm	Filter class to DIN EN 779	Packs of	Model No.
3138..../3139..../ 3140....	Chemical fibre	264 x 95 x 17	G3	12 pc(s).	3174.100

For EMC fan-and-filter units

To fit Model No.	Material	W x H x D mm	Filter class to DIN EN 779	Packs of	Model No.
3237.6..	Copper-nickel-chrome coated chemical fibres	92 x 92 x 10	G2	5 pc(s).	3237.066
3238.6..	Copper-nickel-chrome coated chemical fibres	125 x 125 x 12	G2	5 pc(s).	3238.066
3239.6..	Copper-nickel-chrome coated chemical fibres	178 x 178 x 17	G3	5 pc(s).	3239.066
3240.6../3241.6..	Copper-nickel-chrome coated chemical fibres	226 x 226 x 17	G3	5 pc(s).	3240.066
3243.6../3244.6../ 3245.6..	Copper-nickel-chrome coated chemical fibres	294 x 294 x 17	G3	5 pc(s).	3243.066

For fan-and-filter units

To fit Model No.	Material	W x H x D mm	Filter class to DIN EN 779	Packs of	Model No.
3237....	Chemical fibre	89 x 89 x 10	G2	5 pc(s).	3321.700
3237....	Chemical fibre	89 x 89 x 10	G2	50 pc(s).	3321.705
3238....	Chemical fibre	120 x 120 x 12	G2	5 pc(s).	3322.700
3238....	Chemical fibre	120 x 120 x 12	G2	50 pc(s).	3322.705
3239....	Chemical fibre	173 x 173 x 17	G3	5 pc(s).	3171.100
3239....	Chemical fibre	173 x 173 x 17	G3	50 pc(s).	3171.105
3240..../3241....	Chemical fibre	221 x 221 x 17	G3	5 pc(s).	3172.100
3240..../3241....	Chemical fibre	221 x 221 x 17	G3	50 pc(s).	3172.105
3243..../3244..../ 3245....	Chemical fibre	289 x 289 x 17	G3	5 pc(s).	3173.100
3243..../3244..../ 3245....	Chemical fibre	289 x 289 x 17	G3	50 pc(s).	3173.105

For Thermoelectric coolers

To fit Model No.	Material	W x H x D mm	Filter class to DIN EN 779	Packs of	Model No.
3201.200/3201.300	Chemical fibre	90 x 106 x 8	G2	5 pc(s).	3201.050



Accessories for climate control

Filter technology



Fine filter mat

for fan-and-filter units

Made of chopped-fibre mat with a progressive structure. Temperature-resistant to 100 °C, self-extinguishing category F1 to DIN 53 438. Dust-laden air side: Open structure. Clean-air side: Closed structure. Reliable filtering of virtually all types of dust with a particle size of up to 1 µm.

Material:

- Chemical fibres

Note:

- Performance data, protection category and device approvals are only guaranteed when used in conjunction with original Rittal filter mats.

To fit Model No.	W x H x D mm	Filter class to DIN EN 779	Packs of	Model No.
3238....	120 x 120 x 12	F5/M5	5 pc(s).	3238.055
3239....	173 x 173 x 12	F5/M5	5 pc(s).	3181.100
3240..../3241....	221 x 221 x 12	F5/M5	5 pc(s).	3182.100
3243..../3244..../3245....	289 x 289 x 12	F5/M5	5 pc(s).	3183.100



Pleated filter

for Blue e+ roof-mounted cooling unit and VX25 Blue e+ integration solution

To achieve a protection category of IP 54 with roof-mounted cooling unit Blue e+ and VX25 Blue e+ integration solution.

Material:

- Non-woven fabric

Note:

- Operation without a pleated filter is inadmissible

Filter class to DIN EN 779:

- G4

To fit Model No.	W x H x D mm	Packs of	Model No.
3185.030/ 3185.730	652 x 158 x 15	3 pc(s).	3285.700

Accessories for climate control

Filter technology

Outlet filter

Standard

For ventilation by convection, an outlet filter can be installed in the upper and lower sections of the enclosure.

Material:

- ABS

Colour:

- RAL 7035
- Optionally available in RAL 9005

Protection category IP to IEC 60 529:

- IP 54 including filter mat
- IP 55 with standard filter and additional fine filter
- IP 56 with standard filter and hose-proof hood

Protection category NEMA:

- NEMA 12

Supply includes:

- Outlet filter
- Filter mat



Accessories:

- Spare filter mat, see page 535
- Fine filter mat, see page 536
- Hose-proof hood, see page 538
- Blanking cover, see page 538



W x H x D mm	Required cut-out, width mm	Required cut-out, height mm	Packs of	Model No.
116.5 x 116.5 x 16	92	92	1 pc(s).	3237.200
148.5 x 148.5 x 24	124	124	1 pc(s).	3238.200
204 x 204 x 24	177	177	1 pc(s).	3239.200
255 x 255 x 25	224	224	1 pc(s).	3240.200
323 x 323 x 25	292	292	1 pc(s).	3243.200

Outlet filter

EMC

For ventilation by convection, an outlet filter can be installed in the upper and lower sections of the enclosure.

Material:

- ABS

Colour:

- RAL 7035

Protection category IP to IEC 60 529:

- IP 54 including filter mat
- IP 55 with EMC filter mat and additional fine filter
- IP 56 with EMC filter mat and hose-proof hood

Supply includes:

- Outlet filter
- Filter mat



Accessories:

- Spare filter mat, see page 535
- Fine filter mat, see page 536
- Hose-proof hood, see page 538



W x H x D mm	Required cut-out, width mm	Required cut-out, height mm	Packs of	Model No.
116.5 x 116.5 x 16	92	92	1 pc(s).	3237.060
148.5 x 148.5 x 24	124	124	1 pc(s).	3238.060
204 x 204 x 24	177	177	1 pc(s).	3239.060
255 x 255 x 25	224	224	1 pc(s).	3240.060
323 x 323 x 25	292	292	1 pc(s).	3243.060

Accessories for climate control

Filter technology

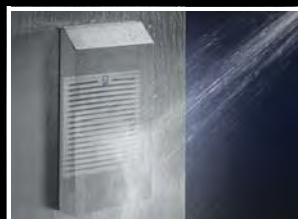

Hose-proof hood

to increase the protection category

For fan-and-filter units/outlet filters. Easy cleaning thanks to exterior silicone coating approved for use with foodstuffs.

Material:

- Stainless steel
- Silicone

Protection category IP to IEC 60 529:

- IP 56 when fitted over fan-and-filter unit/outlet filter with filter mat

To fit Model No.	W x H x D mm	Protection category	Packs of	Model No.
3237....	150 x 230 x 40	NEMA 1 NEMA 12 NEMA 3 NEMA 3R	1 pc(s).	3237.080
3238....	176 x 245 x 55	NEMA 1 NEMA 12 NEMA 3 NEMA 3R NEMA 4 NEMA 4X	1 pc(s).	3238.080
3239....	233 x 330 x 55	NEMA 1 NEMA 12 NEMA 3 NEMA 3R NEMA 4 NEMA 4X	1 pc(s).	3239.080
3240..../3241....	282 x 390 x 85	NEMA 1 NEMA 12 NEMA 3 NEMA 3R NEMA 4 NEMA 4X	1 pc(s).	3240.080
3243..../3244....	350 x 480 x 110	NEMA 1 NEMA 12 NEMA 3 NEMA 3R NEMA 4 NEMA 4X	1 pc(s).	3243.080
3245....	350 x 480 x 160	NEMA 1 NEMA 12 NEMA 3 NEMA 3R	1 pc(s).	3245.080



Blanking cover

for fan-and-filter units / outlet filters

If existing mounting cut-outs for fan-and-filter units/outlet filters need to be closed to achieve a higher protection category, the filter mat of the fan-and-filter unit/outlet filter can simply be replaced with a blanking cover; welding or other mechanical modification of the enclosure is not necessary.

Material:

- PE, closed-cell

Colour:

- Anthracite

Protection category IP to IEC 60 529:

- IP 54

To fit Model No.	W x H x D mm	Packs of	Model No.
3237....	81 x 81 x 6	2 pc(s).	3237.020
3238....	114 x 114 x 8	2 pc(s).	3238.020
3239....	167 x 167 x 15	2 pc(s).	3239.020
3240..../ 3241....	214 x 214 x 15	2 pc(s).	3240.020
3243..../ 3244..../ 3245....	282 x 282 x 15	2 pc(s).	3243.020

Accessories for climate control

Filter technology

Front outlet grille 2 U

for tangential fans

This front outlet grille is required if a 482.6 mm (19") cross-flow blower (SK 3144.000/SK 3145.000) is used in the lower section of the electronic enclosure and the hot air is to be expelled to the outside from the upper section of the enclosure. The design of the grille matches that of the intake grille in the cross-flow blower. These grilles can also be used as simple inflow and outflow grilles with natural convection.

Packs of	Model No.
1 pc(s).	3176.000

+ Accessories:

- Filter mat, see page 533



Enclosure internal fan

To prevent hot-spots and support the air routing of active enclosure climate control components. Adjustable in two axes. Attached to the frame section. Several fans may be cascaded using the quick-release clamping strip.

Supply includes:

- Complete unit with axial fan ready for connection
- Snap-on pivot device
- Assembly parts

Air throughput (unimpeded air flow) m³/h	Rated operating voltage V, ~, Hz	Power consumption W	Rated current A	Packs of	Model No.
160	230, 1~, 50/60	19 / 18	0.12 / 0.11	1 pc(s).	3108.100
160	115, 1~, 50/60	19 / 18	0.24 / 0.23	1 pc(s).	3108.115
160	24 (DC)	3.5	0.15	1 pc(s).	3108.024



Mini fan

Compact DC fan for enclosure and component cooling in enclosures.

Supply includes:

- Fan
- Assembly screws
- Contact hazard protection

W x H x D mm	Air throughput (unimpeded air flow) m³/h	Rated operating voltage V	Power consumption W	Operating temperature range	Noise level dB(A)	Packs of	Model No.
60 x 60 x 25.4	21	24 (DC)	1	-20 °C...+70 °C	20	1 pc(s).	3236.124



Integrated louvres

For ventilation by convection; easily retro-fitted using 4 screws.

Material:

- Sheet steel

Colour:

- RAL 7035

Supply includes:

- Assembly parts

W x H x D mm	Packs of	Model No.
160 x 110 x 8	4 pc(s).	2541.235
210 x 100 x 8	4 pc(s).	2542.235
330 x 110 x 8	4 pc(s).	2543.235

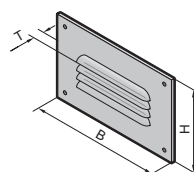

Accessories for climate control

Air routing



Air duct system

for roof-mounted cooling units and roof-mounted air/water heat exchangers

Cold air may be routed directly to specific areas of the enclosure using the air duct system. The risk of air short circuits due to self-ventilated installed devices is therefore eliminated. The dimensions of the shallow duct are W x H x D 229 x 1500 x 29 mm, and can be shortened to the required length.

Material:

- Flame-resistant plastic to DIN 4102/B1

Colour:

- RAL 7035

Supply includes:

- Shallow duct
- Compensating hose

Note:

- Do not direct cold air straight at active components.
- When using the ducting system, the performance of the cooling unit may be reduced, depending on the application in question.
- For devices 3359.../3382..., the air duct adaptor 3286.840 is additionally required.

To fit Model No.	Packs of	Model No.
3209.../3210.../3273.../3359.../3382.../3383.../3384.../3385...	1 pc(s).	3286.870
3386.../3387...	1 pc(s).	3286.970

! Also required:

- Support strip, see page 952

+ Accessories:

- Deflector, 90°, see page 540
- Stoppers, see page 542
- Flat duct extension, see page 541

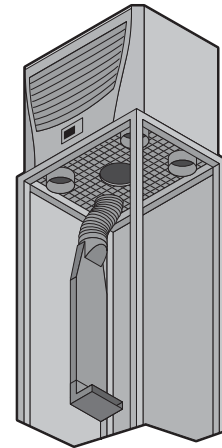

Air duct adaptor

for air duct system and shallow air duct system

The adaptor serves as a connection between the roof-mounted cooling unit (air inlet opening) and the air-duct system.

Material:

- ABS

Colour:

- RAL 9005

To fit Model No.	Packs of	Model No.
3359.../3382...	1 pc(s).	3286.840



Deflector, 90°

for air duct system

For targeted air deflection at the end of the shallow duct.

Material:

- Flame-resistant plastic to DIN 4102/B1

Colour:

- RAL 7035

Packs of	Model No.
1 pc(s).	3286.990

Shallow air duct system

for roof-mounted cooling units and roof-mounted air/water heat exchangers

Cold air may be routed directly to specific areas of the enclosure using the air duct system.

The risk of air short circuits due to self-ventilated installed devices is therefore eliminated.

The dimensions of the shallow duct are W x H x D 229 x 1500 x 29 mm, and can be shortened to the required length.

Applications:

- Suitable for enclosures with widths of 800 mm or more and depths of 600 mm or more

Material:

- Flame-resistant plastic to DIN 4102/B1

Colour:

- RAL 7035

Supply includes:

- Shallow duct
- Adaptor
- Compensating piece
- Deflector, 90°

Note:

- Do not direct cold air straight at active components.
- When using the ducting system, the performance of the cooling unit may be reduced, depending on the application in question.
- Not suitable for use in conjunction with quick-change frame.

To fit Model No.	Packs of	Model No.
3209.../3210.../3273.../ 3383.../3384.../3385.../ 3359.../3382...	1 pc(s).	3286.850

! Also required:

- Air duct adaptor, see page 540
- Support strip, see page 952

🔧 Assembly

- For devices 3359.XXX and 3382.XXX, the air duct adaptor 3286.840 is required for mounting.

+ Accessories:

- Deflector, 90°, see page 540
- Stoppers, see page 542
- Flat duct extension, see page 541

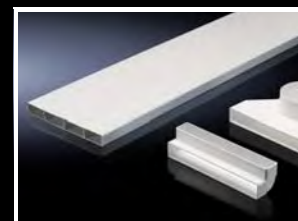

Flat duct extension

Extension kit for shallow air duct system 3286.850 for length compensation in the width, depth or height in enclosures.

Material:

- Flame-resistant plastic to DIN 4102/B1

Colour:

- RAL 7035

Supply includes:

- Shallow duct 1500 mm
- Connecting piece

Packs of	Model No.
1 pc(s).	3286.860



Accessories for climate control

Air routing

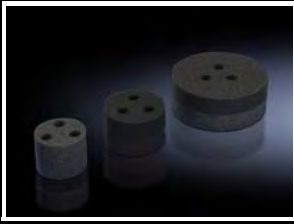

Stoppers

for roof-mounted cooling units and roof-mounted air/water heat exchangers

To cover any cold air outlets that are not required.

Material:

- Polyurethane foam

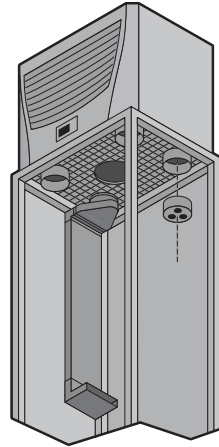

To fit Model No.	Ø mm	Max. no. of stoppers per unit	Packs of	Model No.
3359..../3382....	80	1	2 pc(s).	3286.780
3209..../3210..../3273..../ 3383..../3384..../3385....	100	2	2 pc(s).	3286.880
3386..../3387....	150	1	2 pc(s).	3286.980



Air diverter

For use with wall-mounted cooling units, for targeted routing of cold air in a downward direction. Particularly well-suited for densely-packed electrical components in the lower section of the enclosure.

Material:

- Sheet steel

Colour:

- RAL 7035

To fit Model No.	Installation depth mm	Packs of	Model No.
3304..../3305....	65	1 pc(s).	3213.310
3328..../3329....	65	1 pc(s).	3213.320

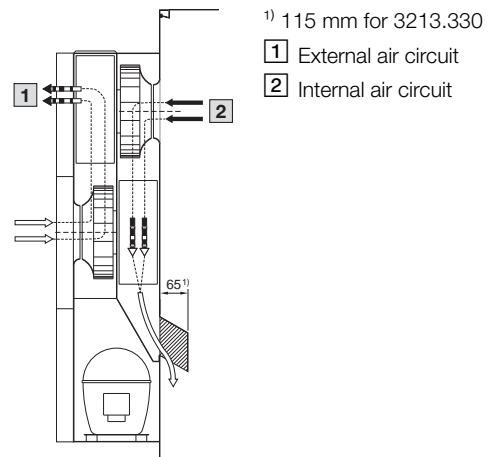

Accessories for climate control

Water distribution

Electric condensate evaporator

For external mounting on the enclosure. For use with all enclosure cooling units and air/water heat exchangers (wall-mounted).

Benefits:

- Suitable for international use thanks to multi-voltage support

Colour:

- RAL 7035

Supply includes:

- Electric condensate evaporator, ready to connect

W x H x D mm	Rated operating voltage V, ~, Hz	Operating temperature range	Evaporation performance	Packs of	Model No.
280 x 129 x 105	115 - 230, 1~, 50/60	+5 °C...+60 °C	230 V: 3.5 l/d 115 V: 3.0 l/d	1 pc(s).	3301.500
400 x 129 x 105	115 - 230, 1~, 50/60	+5 °C...+60 °C	230 V: 3.5 l/d 115 V: 3.0 l/d	1 pc(s).	3301.505



Electrical condensate evaporator

for Blue e+ roof-mounted cooling units

Tool-free mounting of the condensate evaporator on the underside of the roof-mounted Blue e+ so that it is not visible from the outside. Any condensation is evaporated and emitted to the ambient air via the air exhaust of the cooling unit.

Material:

- Plastic

Colour:

- RAL 9005

Supply includes:

- Electrical condensate evaporation
- Shipping brace screw
- Entry grommet

Note:

- Power is supplied via the cooling unit

To fit Model No.	W x H x D mm	Rated operating voltage V (DC)	Operating temperature range	Evaporation performance	Packs of	Model No.
3185.730	89 x 121 x 158	380	+5 °C...+60 °C	100 ml/h	1 pc(s).	3355.720



Accessories for climate control

Water distribution



Condensate collecting bottle

For mounting on the enclosure. For use with all enclosure cooling units and air/water heat exchangers. Safety overflow at the side. Capacity approximately 0.75 l.

Supply includes:

- Condensate collecting bottle
- Bottle holder
- Assembly parts

Packs of	Model No.
1 pc(s).	3301.600

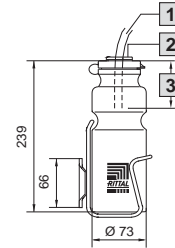

- 1** Condensate discharge tube
- 2** Membrane grommet
- 3** Max. 70 mm

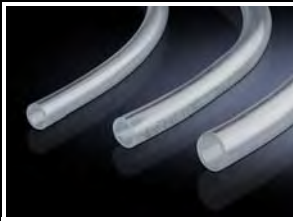

Condensate hose

For discharging and transporting condensate. For connection to enclosure cooling units and air/water heat exchangers.

Material:

- PVC, transparent

To fit Model No.	Length m	Ø mm	Material thickness mm	Packs of	Model No.
3201....	5	6	1	1 pc(s).	3301.606
3302.300/3302.310	10	8	1.5	1 pc(s).	3301.608
3212.../3303.../3361.../3302.1xx/ 3302.2xx	10	10	1.5	1 pc(s).	3301.610
3209...3210/3214.100/3215.100/ 3216.480/3273.../3304...3305/ 3328...3329/3332.../3359.../ 3363...3364/3366.../3373...3375/ 3377...3378/3382...3385/3386...3387/ 3185.830/3185.530/3186.930/ 3186.630/3187.930/3187.630/ 3188.940/3188.640/3189.940/ 3189.640	10	12	2	1 pc(s).	3301.612

Accessories for climate control

Water distribution

Connection set

for air/water heat exchangers

For professional laying of water connections and regulation of volumetric flow. The pressure hoses may be cut to length individually, depending on the application.

Material:

- Water-carrying parts EPDM/brass

Supply includes:

- Hose for water return
- Hose for water inlet including regulator valve for regulating the volumetric flow (setting range 3 to 12 l/min)
- Assembly parts

To fit Model No.	Length mm	Water connections	Permissible operating pressure (p. max.) bar	Packs of	Model No.
3209.XX0/3210.XX0/3216.480/ 3363.XX0/3364.XX0/3373.XX0/ 3374.XX0/3375.XX0	3600	G 3/8" internal thread	1 - 10	1 pc(s).	3201.990

Flow regulator valve

For use with air/water heat exchangers, especially if more than one heat exchanger ($n > 1$) is used in the water cooling circuit. The correctly set valve then ensures the same quantity of cooling medium for all equipment.

Applications:

- The valve is used for hydraulic balancing.

Material:

- Brass

Design	Setting range l/min	Packs of	Model No.
3/4" x 1/2" for volumetric flow control	3 - 12	1 pc(s).	3301.930
3/4" x 3/4" for volumetric flow control	3 - 12	1 pc(s).	3301.940

Cooling medium (ready-mixed)

For chillers and air/water heat exchangers

As well as protecting against frost, this cooling medium also serves to inhibit bacterial growth and provide optimum corrosion protection.

Application	Antifreeze/water mixture	Container	Contents l	Operating temperature range	Packs of	Model No.
Outdoor	1 : 2	Canister	10	-20 °C...+60 °C	1 pc(s).	3301.950
Outdoor	1 : 2	Canister	25	-20 °C...+60 °C	1 pc(s).	3301.955
Standard	1 : 4	Canister	10	-10 °C...+60 °C	1 pc(s).	3301.960
Standard	1 : 4	Canister	25	-10 °C...+60 °C	1 pc(s).	3301.965

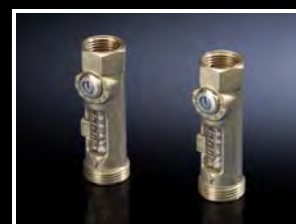

Accessories for climate control

Control/regulation



Digital enclosure internal temperature display and thermostat

For installation in the enclosure door or wall.

Technical specifications:

- Three-digit, 7-segment display
- Option of switching between °C/°F
- Includes 1800 mm long NTC sensor
- Two relay outputs as change-over contact and normally open contact (max. contact load 230 V, 6 A)
- Freely selectable switching difference

Colour:

- RAL 7035

Protection category IP to IEC 60 529:

- IP 54

Rated operating voltage V, ~, Hz	Installation depth mm	Setting range	Operating temperature range	Packs of	Model No.
100 - 230, 1~, 50/60 24 - 60 (DC)	100	+5 °C...+55 °C	+0 °C...+50 °C	1 pc(s).	3114.200



Digital enclosure internal temperature display and thermostat

integrated into a patch panel 1 U

Including cable attachment for connection cable and label holder.

Technical specifications:

- Three-digit, 7-segment display
- Option of switching between °C/°F
- Includes 1800 mm long NTC sensor
- Two relay outputs as change-over contact and normally open contact (max. contact load 230 V, 6 A)
- Freely selectable switching difference

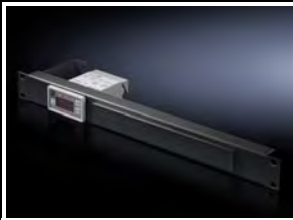

Rated operating voltage V, ~, Hz	Installation depth mm	Setting range	Colour	Packs of	Model No.
100 - 230, 1~, 50/60 24 - 60 (DC)	100	+5 °C...+55 °C	RAL 7035	1 pc(s).	7109.035
100 - 230, 1~, 50/60 24 - 60 (DC)	100	+5 °C...+55 °C	RAL 9005	1 pc(s).	5302.041

Thermostat

Enclosure internal thermostat

Particularly suitable for controlling fans, heaters and heat exchangers, this thermostat can also be used as a signal generator for monitoring the enclosure internal temperature.

Benefits:

- Time-saving connection technique using a terminal strip with a screw connection from the outside
- Flexible mounting on a vertical or horizontal 35 mm support rail to EN 50 022, and snap fastening in the enclosure section or on the mounting plate using the supplied adaptor

Technical specifications:

- Bi-metal controller as a temperature-sensitive element with thermal feedback
- Contact population: Single-pole change-over contact as a quick-break contact
- Permissible contact load: Category 5 – 3 (heating) AC 10 (4) A (inductive load at $\cos \phi = 0.6$)/category 5- 4 (cooling): AC 5 (4) A (inductive load at $\cos \phi = 0.6$)/DC = max. 30 W
- Switching difference: approx. 1 K \pm 0.8 K

Colour:

- RAL 7035



Accessories:

- Bottom-mounted adaptor, see page 548
- Mounting plate, see page 998



W x H x D mm	Rated operating voltage V, ~	Setting range	Packs of	Model No.
71 x 71 x 33.5	24 - 230, 1~ 24 - 60 (DC)	+5 °C...+60 °C	1 pc(s).	3110.000

Hygostat

Activates the heater and/or fan when a preset relative humidity in the enclosure is exceeded. This reduces the relative humidity and prevents condensation on assemblies and electronic components.

Benefits:

- Time-saving connection technique using a terminal strip with a screw connection from the outside
- Flexible mounting on a vertical or horizontal 35 mm support rail to EN 50 022, and snap fastening in the enclosure section or on the mounting plate using the supplied adaptor

Technical specifications:

- Contact population: Single-pole change-over contact as a quick-break contact
- Permissible contact load: AC ~ 5 (0.2) A (inductive load at $\cos \phi = 0.6$)/DC = max. 20 W
- Setting range: 50 – 100% relative humidity
- Switching difference: approx. 4%

Colour:

- RAL 7035

W x H x D mm	Rated operating voltage V, ~	Packs of	Model No.
71 x 71 x 33.5	24 - 250, 1~ 24 - 75 (DC)	1 pc(s).	3118.000



Accessories:

- Bottom-mounted adaptor, see page 548
- Mounting plate, see page 998



Accessories for climate control

Control/regulation



Bottom-mounted adaptor for enclosure internal thermostat and hygrostat

With mounting option for screwed cable glands, for targeted cable infeed from appropriate equipment such as SK fan-and-filter units and enclosure heaters. In conjunction with screwed cable glands, it also provides strain relief.

Colour:
– RAL 7035

To fit Model No.	Packs of	Model No.
3110.000/3118.000	1 pc(s).	3110.200



EC speed control

Control unit for EC fan

Temperature-dependent speed control for EC fans to reduce noise and save energy. The function of the fan can also be monitored.

Functions:

- Activation and monitoring of up to 4 EC fan-and-filter units
- For mounting on a 35 mm support rail EN 50 022
- External temperature sensor to record the actual temperature
- Status LED to display the operating status
- Alarm relay for reporting overtemperature, fan defect, cable break and sensor failure

Supply includes:

- Speed control
- NTC sensor, length 1.80 m

To fit Model No.	Rated operating voltage V	Setting range	Packs of	Model No.
3240.500/3241.500/3243.500/ 3244.500/3245.XXX/3140.500/ 3140.510	100 - 250	+5 °C...+55 °C	1 pc(s).	3235.440



EC speed control

Sensor for speed control

NTC sensor for temperature-dependent speed control of EC fans to reduce noise and save energy. Activation and power supply via an EC fan-and-filter unit.

Technical specifications:

- Control characteristic: fixed setpoint at 35 °C, with linear control range between +35 °C (maximum speed 100%) and +20 °C (minimum speed 10%)

Protection category IP to IEC 60 529:

- IP 40

Supply includes:

- External sensor with connection cable (length 3 m)

To fit Model No.	Rated operating voltage V	Operating temperature range	Packs of	Model No.
3240.500/3241.500/ 3243.500/3244.500/ 3245.XXX/3140.500/ 3140.510	10 - 12 (DC)	-25 °C...+80 °C	1 pc(s).	3235.450

Speed control

For fan-and-filter units and air/air heat exchangers

Temperature-dependent speed control to minimise noise and save energy in part-load operation.

Technical specifications:

- For mounting on a 35 mm support rail EN 50 022
- Phase cross-over with microcontroller
- Maximum fan output 300 W or 2 A

Supply includes:

- Speed control
- NTC sensor, length 1.80 m

Note:

- Only suitable for use with single-phase AC motors and equipment
- Not suitable for EC motors



Accessories:

- Mounting plate, see page 998

W x H x D mm	Rated operating voltage V	Setting range	Packs of	Model No.
105 x 90.5 x 60.2	100 - 230	+20 °C...+55 °C	1 pc(s).	3120.200

Temperature sensor

for Blue e+ cooling units, Blue e+ chillers

NTC sensor to regulate Blue e+ cooling units according to an individual measurement point within the enclosure (control based on an external sensor), and according to the cold air outlet from the cooling unit inside the enclosure (control based on outlet temperature). For chillers: Differential control is used if it is necessary to regulate the temperature of the medium depending on the ambient temperature (positive or negative). For this, the temperature sensor needs to be positioned near the Blue e+ chiller.

Supply includes:

- External sensor with connection cable (length 2.5 m)

Packs of	Model No.
1 pc(s).	3124.400



Accessories for climate control

Control/regulation



Master/slave cable

for SK BUS system

The SK BUS system allows several cooling units and air/water heat exchangers with e-Comfort controller to communicate with one another Master-slave configuration for complex bayed enclosure systems, for optimum operating results.

Technical specifications:

- The master-slave layout facilitates common activation and deactivation via door limit switches, parallel activation and deactivation via a temperature setpoint, and common collective fault signals and temperature logging, eliminating the need for intricate wiring.

Supply includes:

- 3 m shielded interface cable
- Operating instructions on programming the cooling units

Note:

- $n_B = n_K - 1$
- n_B : Number of order units (SK BUS system)
- n_K : Number of cooling units to be linked

Packs of	Model No.
1 pc(s).	3124.100



Toroidal transformer

Primary connection 115 V/400 V

For the power supply of wall-mounted 230 V air/water heat exchangers. Available with 115 V or 400 V primary connection.

Technical specifications:

- Output 110 VA
- Voltage tolerance $\pm 10\%$
- Primary connection 3500 mm long
- Secondary connection 1500 mm long
- For mounting on a 35 mm support rail EN 50 022

Supply includes:

- Toroidal transformer
- Assembly parts

To fit Model No.	W x H x D mm	Rated operating voltage V, ~, Hz	Packs of	Model No.
3363.X0X/3364.X0X/3212.230/ 3214.100/3214.700/3215.100/ 3215.700	105 x 123 x 55	400 (primary), 2~, 50/60 230 (secondary), 1~, 50/60	1 pc(s).	3201.960
3363.X0X/3364.X0X/3214.100/ 3214.700/3215.100/3215.700	105 x 123 x 55	115 (primary), 1~, 50/60 230 (secondary), 1~, 50/60	1 pc(s).	3201.970

IoT interface

Digitalised and networked



Industrial Internet of Things

- Fast, uninterrupted, automated production
- The Industrial Internet of Things (IIoT) makes it possible.



Condition monitoring for rack and process cooling

- In conjunction with the IoT interface, Rittal cooling solutions can now be networked and digitalised
- Continuous monitoring plays a key role in boosting system availability.



Climate control

Sensors for enclosure monitoring

- The use of Rittal sensors allows reliable monitoring of a wide range of switchgear parameters.
- Potential failures are identified early on, and operational reliability is increased



Rittal Smart Service

- Data-based service for visualising the response of your networked cooling solutions
- Overview of energy and CO₂ consumption
- Centralised detection of maintenance requirements and critical errors, including recommended actions
- Fast problem analysis and troubleshooting



Accessories for climate control

Control/regulation



IoT interface

The IoT interface is a central component for the intelligent networking of Rittal cooling solutions or sensors for monitoring physical ambient conditions. Equipped with a wide range of interfaces and protocols, it is used to collate and transmit data to superordinate IT systems or to systems for the local monitoring of machine statuses.

Benefits:

- Digitalisation and networking offer huge opportunities for every company. With the IoT interface, Rittal cooling solutions and sensors for monitoring physical ambient conditions are easily connected to Industry 4.0 environments without affecting the automation logic.
- Plug and run: The IoT interface is quickly and conveniently configured and commissioned via the integral Web server, no programming required.

Material:

- Plastic to UL 94-V0

Colour:

- RAL 7016

Protection category IP to IEC 60 529:

- IP 20

Supply includes:

- IoT interface
- USB cable (USB-A connector on micro-USB-B connector)
- Angle bracket for Blue e+ cooling unit

Note:

- The IoT interface is only supported by Blue e+ cooling units from firmware version 1.11.0 or above. If applicable, update the firmware using the RiDiag III software (3159.300).
- To interlink cooling units in the Blue e series, the Blue e IoT adaptor (3124.310) is additionally required.



Assembly

- The IoT interface can be secured on a 35 x 7.5 top hat rail to DIN EN 60715 using a spring-loaded metal clip, or to the rear of a Blue e+ cooling unit using the angle bracket.



Accessories:

- Blue e IoT adaptor, see page 555

W x H x D mm	18 x 117 x 120
For	TopTherm cooling units with e-Comfort controller Blue e+ cooling units Blue e+ chillers Smart Monitoring System for NH fuse-switch disconnectors Rittal sensors
Operating temperature range	+0 °C...+70 °C
Protocols	OPC-UA/SNMPv1/SNMPv2c/SNMPv3/Modbus/TCP/TCP/IPv4/TCP/IPv6/Radius/Telnet/SSH/FTP/SFTP/HTTP/HTTPS/NTP/DHCP/DNS/SMTP/Syslog/LDAP
Interfaces	1 x Micro USB type B (device) for USB 2.0 1 x Micro-SD memory card slot for SD 2.0 1 x USB 2.0 high-speed functions (EHCI) 1 x acknowledgement button 1 x push-in spring connection terminal for NTC sensor 2 x RJ45 jack for RS 485 interface (climate control unit interface)
Network interface	Ethernet IPv4/IPv6 Ethernet to IEEE 802.3 via 10BASE-T, 100BASE-T and 1000BASE-T
Interface bus system	2 x RJ45 CAN bus
Type of electrical connection	Push-in spring connection terminal (24 V DC)
Weight kg	0.278
Packs of	1 pc(s).
Model No.	3124.300

Blue e IoT adaptor

In conjunction with the IoT interface, the adaptor supports intelligent networking of cooling units in the Blue e series.

Benefits:

- Digitalisation and networking offer huge opportunities for every company. In conjunction with the IoT interface (3124.300), cooling units in the Blue e series are easily connected to Industry 4.0 environments without affecting the automation logic.
- Plug and run: The IoT interface is quickly and conveniently configured and commissioned via the integral Web server, no programming required.
- Condition monitoring of up to 10 cooling units in a master/slave arrangement

Material:

- Plastic
- Front: Smooth
- Enclosure: Textured

Colour:

- Front: RAL 9005
- Enclosure: RAL 7035

Protection category IP to IEC 60 529:

- IP 30

Supply includes:

- Blue e IoT adaptor
- Installation and Short User's Guide
- Mounting bracket
- Assembly parts
- Sub-D to RJ11 connection cable
- Mounting clips for securing top-hat rails



Also required:

- IoT interface, see page 554



To fit Model No.	3303.5/6xx/3304.5/6xx/3305.5/6xx/3328.5/6xx/3329.5/6xx/3332.5/6xx/3361.5/6xx/3366.5/6xx/3377.5/6xx/3307.7xx/3310.7xx/3382.5/6xx/3359.5/6xx/3383.5/6xx/3273.500/3384.5/6xx/3385.5/6xx/3386.5/6xx/3387.5/6xx/9776.550
W x H x D mm	80 x 30 x 40
For	TopTherm cooling units with e-Comfort controller
Operating temperature range	+0 °C...+55 °C
Interfaces	1 x Modbus RTU 1 x cooling unit interface
Weight kg	0.201
Packs of	1 pc(s).
Model No.	3124.310

Accessories for climate control

Mounting accessories

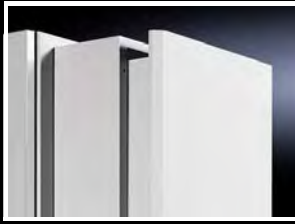

Trim frame

for slimline cooling units

Slimline cooling units can be internally or externally mounted on an enclosure door or wall. The trim frame presents a closed front for the cooling unit.

Material:

- Sheet steel

Colour:

- RAL 7035

Supply includes:

- Trim frame
- Sealing and assembly parts

To fit Model No.	W x H x D mm	Packs of	Model No.
3366....	448 x 1583 x 140	1 pc(s).	3377.000

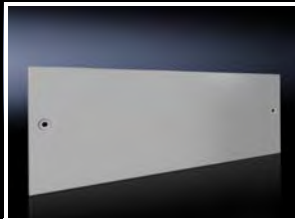
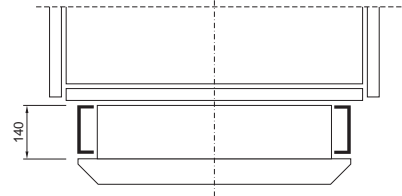

Baying plate

for VX25 Blue e+ integration solution

The baying plate guarantees a protection category of IP 54 when baying the VX25 Blue e+ integration solution to a 2,000 mm high, 600 mm deep enclosure.

Material:

- Sheet steel

Colour:

- Textured RAL 7035

Supply includes:

- Baying plate
- Cross member
- Assembly parts and sealing material

To fit Model No.	W x H x D mm	Packs of	Model No.
3185.030	600 x 200 x 17	1 pc(s).	3355.710



Quick-change frame

for roof-mounted cooling units

The quick-change frame is more than just an alternate frame. Together with the seal, the lower part of the frame is screw-fastened to the enclosure. In this way, it is possible to install and remove the connector-ready cooling unit with the upper part of the alternate frame previously mounted on the cooling unit with quick-release fasteners. During servicing work, this means shorter assembly times and hence minimised downtime. What is more, the quick-change frame offers effective protection against the ingress of oil into the enclosure in oily atmospheres, thanks to its integral drainage trough.

Material:

- Sheet steel

Colour:

- RAL 7035

Supply includes:

- Quick-change frame
- Seal
- Quick-release fasteners

To fit Model No.	Packs of	Model No.
3359.../3382....	1 pc(s).	3286.700
3209.../3210.../3383.../3384.../3385....	1 pc(s).	3286.800
3386.../3387....	1 pc(s).	3286.900

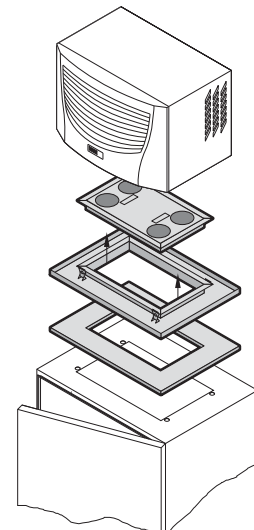

Accessories for climate control

Mounting accessories

Guide frame

for Vario rack-mounted fan

Supply includes:

- Guide frame
- Connector and fitted connection cable
- Mounting bracket for optional attachment to the 482.6 mm (19") mounting level
- Assembly parts



To fit Model No.	Suitable for rated operating voltage	Length of connection cable m	Packs of	Model No.
3350.230/3351.230/ 3352.230	115 V, 50/60 Hz 230 V, 50/60 Hz	3	1 pc(s).	3355.100
3352.500	24 V DC 115 - 230 V	3	1 pc(s).	3357.100

Display frame

for Blue e+ roof-mounted cooling unit and VX25 Blue e+ integration solution

The display frame allows the touch display of the roof-mounted cooling unit Blue e+ or the VX25 Blue e+ integration solution to be positioned in the enclosure door.

Benefits:

- For positioning the display at the optimum operator height

Material:

- Plastic

Colour:

- RAL 7016

Protection category IP to IEC 60 529:

- IP 54

Supply includes:

- Display frame
- Blanking cover
- RJ 12 extension cable (3 m)
- Assembly parts and sealing material

To fit Model No.	W x H x D mm	Packs of	Model No.
3185.030/ 3185.730	316 x 118 x 27.5	1 pc(s).	3355.700



Climate control software

Configurators/tools/CAD data

Climate control

The optimum design, control and monitoring of the installation are crucial to efficient climate control. We support you with user-friendly tools and software for rapid calculation, plus Web-based tools and interfaces to easily control your climate control solution.

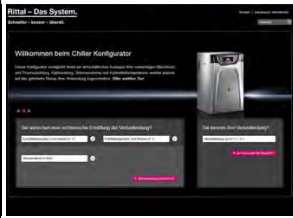

Chiller configurator

The chiller configurator is the cost-effective way to design your required machine and process cooling. Cooling output, volumetric flow and refrigerant temperatures are precisely tailored to your required application.

Benefits:

- Calculate the heat loss, either mathematically or manually
- Comprehensive range of accessories
- Drawings downloadable in dwg, pdf, or 3D pdf format
- Downloadable specifications/tender texts
- Interactive performance diagram: cooling output and pump output
- Add option packages and download bill of materials
- Transfer order list to shopping basket
- Send a quote request

Note:

- Configure online at www.rittal.com/configurators

Chiller app

The Rittal Chiller app allows users to make their selections from a mobile device. Alongside the existing online version of the chiller configurator, the app also supports automated calculation of the required cooling output. The matching chiller may be selected interactively in just four steps, with outputs ranging from 1 to 40 kW.

Note:

- Download free from the App Store



iPhone app



Therm software

Precise, efficient climate control

Therm undertakes the time-consuming calculation of the required cooling output and selects suitable products. The calculation provides you with detailed documentation for maximum peace of mind when designing the optimum climate control. Therm is based on the requirements of IEC/TR3 60890 AMD 1 and DIN 3168 for enclosure cooling units. The overtemperature to DIN 61439 is calculated with a single click.

Benefits:

- Fast, thorough determination of the required climate control measures
- Identification of the correct climate control measures can cut costs
- Easy calculation of the required actual cooling output, as well as any upgrades or enhancements to the switchgear
- Detailed documentation is supplied with the calculation

Note:

- Configure online at www.rittal.com/software



Therm app

Note:

- Downloaded free from the App Store and from the Google Play Store



Android app



iPhone app

Climate control software

Configurators/tools/CAD data

RiDiag II

For the diagnosis, maintenance and long-term data capture of TopTherm units with e-Comfort controller. RiDiag logs equipment data and prepares an error list. RiDiag also offers the option of displaying and setting the device's operating parameters. Logged measurement data can be tracked in real time in the form of a diagram.

Packs of	Model No.
1 pc(s).	3159.100

Note:

- Download free at www.rittal.com/software



RiDiag III

Diagnosis software for the analysis and parameterisation of cooling units and chillers in the Blue e+ series.

	Model No.
¹⁾ This additional function can be enabled with a chargeable licence	3159.300

Note:

- Download RiDiag III for free at www.rittal.com/software



The following functions may be used in the device and efficiency cockpit:

- Quick analysis and setting of all parameters
- Display configuration: e.g. NFC, language, PIN
- Reading of historical data from the last two years¹⁾
- Creation of service enquiries and selection of spare parts
- Software and firmware updates for devices

Blue e+ app

The Blue e+ app supports the contactless exchange of information as well as quick on-site analysis via the NFC interface.

Benefits:

- Saves time when reading the units
- Limit access by requesting a PIN (PIN of cooling unit)
- Superior operational reliability, thanks to improved fault and maintenance management
- Identical displays and menu prompting as on the Blue e+ device display
- Direct link to Rittal Service
- Simply send repair, maintenance and spare parts enquiries from your smartphone

Note:

- Download for free from the Google Play Store



Android app



Boosting efficiency through automation

Rittal has all the machines and devices you need – The Rittal Automation Systems division can supply everything you need to make panel building and switchgear manufacturing easier, faster, more accurate and more reproducible through automation. This allows you to link all work operations together into one highly efficient, digitally seamless, automated process. Manual handling aids and a wide selection of hand tools are available from a single source and can be ordered directly from Rittal.

Further information, machines and devices can be found in the brochure “Rittal Automation Systems – Automate your panel building and switchgear manufacturing”.

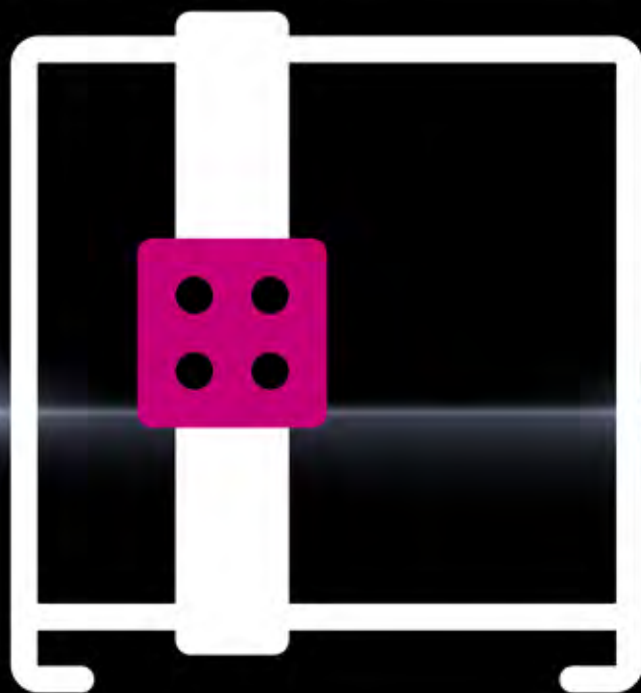

ENCLOSURES

POWER DISTRIBUTION

CLIMATE CONTROL

RITTAL AUTOMATION SYSTEMS

Tools

Tool bag	565
Screwdrivers.....	566
Hex wrenches.....	570
Bits and bit holders.....	571
Crimping pliers.....	574
Wire end ferrules.....	578
Insulation stripping tools	583
Cutting tools	585
Pliers	587
Mechanical tools.....	590
Hole punching tools.....	592
Wiring duct cutter MC 125.....	604
Support rail cutter MC3	605

Handling

Assembly frame	606
Accessories for assembly frame	608
Storage and transport trolley LT 1000.....	611
Functional trolley.....	612
Smart Lifter.....	614
Wire Station WS 540	618
Accessories for Wire Station WS 540.....	621

Wire processing and wiring

Length-cutting machine C8+	632
Stripping machine S22	633
Crimping machine R8 E.....	634
Crimping machine L8.....	635
Crimping machine RC.....	636
Accessories for wire processing machines.....	637

Machining

Busbar machining, static CW 120-S	638
Busbar machining, mobile CW 120-M.....	639
Accessories for busbar machining CW 120	643

Machines for machining, wire processing and assembly

Cutting centre Secarex AC 18	650
Milling centre Perforex BC	652
Laser centre Perforex LC	654
Fully automated wire processing machine Wire Terminal WT	656
Terminal block assembly centre Athex TC 80 CS.....	658

Harness your potential for greater productivity

Rittal offers quality tools made from high-quality materials and semi-automated machines for wire assembly and copper processing for professional industry use.

Ergonomic, efficient handling systems for transport and lifting operations round out our standard portfolio.

We can supply all the machining and handling technology you need for time-saving and cost-cutting manufacturing processes, all from a single source.



ENCLOSURES

POWER DISTRIBUTION

CLIMATE CONTROL

FRIEDHELM LOH GROUP



Perfecting the hand tool

High-quality hand tools for professional use in industry and trade,
from page 565



Simplify handling

Ergonomic, efficient handling systems for transport and lifting operations,
from page 606

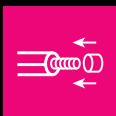

Systematise wire processing

Professional, rational solutions for manual wire machining and processing
Crimping tools, from page 574
Semi-automatic machines, from page 632

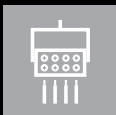

Streamline wiring

To complete the process chain, Rittal Automation Systems are involved in
developing pioneering wiring solutions, right through to full automation.



Automate machining

Fully automated milling or laser machining, plus machining of cable ducts
and busbars
Busbar machining, from page 638



Make component mounting more flexible

Automatic manufacturing and component mounting of terminal strips,
from page 658

The right tool for every application!

All from a single source – Rittal offers a comprehensive range of hand-held tools for professional support with your work operations. All the machining and handling technology you need for time-saving and cost-cutting manufacturing processes, all from a single source.



- Pliers
- Cutting tools

- Tools for cable processing



- Screwdrivers, insulated
- Screwdrivers, uninsulated

- Bits
- Bit holders

- Manual and electric hand-held hydraulic punches

- Hole punches

Tool bag

Configured

Configured tool bag comprising a selected range of Rittal hand tools, designed especially for electricians. The practical, high-quality shoulder bag may be used either as a tool bag or laptop case.

Design:

- 19 separate compartments for tools
- Cushioned compartment for laptop or tablet
- Document wallet
- Two additional storage pockets inside

Benefits:

- Careful storage
- Shoulder pad for comfortable carrying
- Flexible use

Material:

- Polyester

Supply includes:

- Screwdriver, insulated SL 3.5 x 0.6 (Model No.: 4052.102), SL 6 x 1.2 (Model No.: 4052.107), PZ 2 (Model No.: 4052.122)
- Screwdriver, non-insulated PZ 2 (Model No.: 4052.022), SL 6 x 1.2 (Model No.: 4052.011), TX 20 (Model No.: 4052.055), TX 25 (Model No.: 4052.056), TX 30 (Model No.: 4052.058)
- Bit holder with handle, magnetic (Model No.: 4053.300)
- Bit set with bit holder, 7-piece (Model No.: 4053.420)
- Crimping pliers for wire end ferrules, for cross-section 0.5 - 6 mm², square crimp (Model No.: 4054.001)
- Wire stripper for wire end ferrules, for cross-section 0.02 - 11 mm² (Model No.: 4054.300)
- Stripping tools for cables Ø 2.5 - 11 mm (Model No.: 4054.400), for cables Ø 8 - 13 mm (Model No.: 4054.405)
- Side cutter for cables Ø 0.2 - 11 mm (Model No.: 4054.600)
- Electrician's scissors for cables Ø 0.1 - 3.7 mm (Model No.: 4054.700)
- Combination pliers with insulated handle (Model No.: 4054.800)
- Needle-nose pliers with insulated handle (Model No.: 4054.850)
- Tool bag (Model No.: 4053.000)

Width mm	Height mm	Depth mm	Packs of	Model No.
420	340	190	1 pc(s).	4053.500

Tool bag

Unconfigured

The practical, high-quality shoulder bag may be used either as a tool bag or laptop case.

Design:

- 19 separate compartments for tools
- Cushioned compartment for laptop or tablet
- Document wallet
- Two additional storage pockets inside

Benefits:

- Careful storage
- Shoulder pad for comfortable carrying
- Flexible use

Material:

- Polyester

Width mm	Height mm	Depth mm	Packs of	Model No.
420	340	190	1 pc(s).	4053.000



Screwdrivers

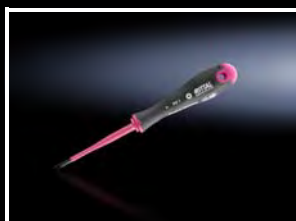

Screwdrivers

insulated

With a long, slender handle and high-performance tip with non-transfer insulation.

Design:

- Isolation protection 1000 V

Benefits:

- Minimal force required, thanks to ergonomically styled handle
- Handle head with anti-roll protection and clear screw labelling
- Black coated blade tip to preserve precision and accuracy of fit
- Handle 30% and insulation up to 50% slimmer than comparable tools
- Optimum interconnection of hand and handle supports higher torques and longer, fatigue-free working

Material:

- Blade: Chrome-molybdenum-vanadium alloy
- Handle core: Hard plastic
- Handle body: Elastic, highly flexible plastic

Colour:

- Handle: Anthracite and Rittal Power Pink

Standards:

- IEC 60 900

Approvals:

- VDE
- TÜV-tested safety

For slot-head screws

Blade tip	Blade (width x thickness) mm	Blade length mm	Blade dia. mm	Handle length mm	Handle dia. mm	Packs of	Model No.
SL	3 x 0.5	100	3.5	105	25	1 pc(s).	4052.101
SL	3.5 x 0.6	100	3.5	105	25	1 pc(s).	4052.102
SL	4 x 0.8	100	4	105	25	1 pc(s).	4052.104
SL	5.5 x 1	125	5.5	115	27	1 pc(s).	4052.106
SL	6.5 x 1.2	125	6.5	115	27	1 pc(s).	4052.107

For Pozidriv screws

Blade tip	Blade (width x thickness)	Blade length mm	Blade dia. mm	Handle length mm	Handle dia. mm	Packs of	Model No.
PZ 1	–	80	4.5	105	25	1 pc(s).	4052.121
PZ 2	–	100	6	115	27	1 pc(s).	4052.122

For Phillips-head screws

Blade tip	Blade (width x thickness)	Blade length mm	Blade dia. mm	Handle length mm	Handle dia. mm	Packs of	Model No.
PH 1	–	80	4.5	105	25	1 pc(s).	4052.131
PH 2	–	100	6	115	27	1 pc(s).	4052.132

For plus/minus

Blade tip	Blade (width x thickness)	Blade length mm	Blade dia. mm	Handle length mm	Handle dia. mm	Packs of	Model No.
Z 1	–	80	4.5	105	25	1 pc(s).	4052.141
Z 2	–	100	6	115	27	1 pc(s).	4052.142

Screwdriver set

insulated

Multi-part screwdriver set. With a long, slender handle and high-performance tips with non-transfer insulation.

Design:

- Isolation protection 1000 V

Benefits:

- Minimal force required, thanks to ergonomically styled handle
- Handle head with anti-roll protection and clear screw labelling
- Black coated blade tip to preserve precision and accuracy of fit
- Handle 30% and insulation up to 50% slimmer than comparable tools

Material:

- Blade: Chrome-molybdenum-vanadium alloy
- Handle core: Hard plastic
- Handle body: Elastic, highly flexible plastic

Colour:

- Handle: Anthracite and Rittal Power Pink

Supply includes:

- Set with 5 screwdrivers

Standards:

- IEC 60 900

Approvals:

- VDE
- TÜV-tested safety

Blade tip	Packs of	Model No.
SL 3 x 0.5 mm SL 4 x 0.8 mm SL 5.5 x 1 mm PH 1 PH 2	1 pc(s).	4052.210
SL 3 x 0.5 mm SL 4 x 0.8 mm SL 5.5 x 1 mm PZ 1 PZ 2	1 pc(s).	4052.211
SL 3 x 0.5 mm SL 4 x 0.8 mm PH 1 PH 2 Z 2	1 pc(s).	4052.212



Screwdrivers



Screwdrivers

uninsulated

Ergonomic screwdriver which adapts perfectly to the hand, thereby minimising the force required.

Benefits:

- Handle head with anti-roll protection and clear screw labelling
- Black coated blade tip to preserve precision and accuracy of fit
- Optimum interconnection of hand and handle supports higher torques and longer, fatigue-free working

Material:

- Blade: Chrome-molybdenum-vanadium alloy
- Handle core: Hard plastic
- Handle body: Elastic, highly flexible plastic

Colour:

- Handle: Anthracite and Rittal Power Pink

Approvals:

- TÜV-tested safety

For slot-head screws

Blade tip	Blade (width x thickness) mm	Blade length mm	Blade dia. mm	Handle length mm	Handle dia. mm	Packs of	Model No.
SL	2.5 x 0.4	75	2.5	86	25	1 pc(s).	4052.001
SL	3.5 x 0.6	100	3.5	86	25	1 pc(s).	4052.003
SL	4 x 0.8	100	4	94	30	1 pc(s).	4052.004
SL	5.5 x 1	150	5	101	33	1 pc(s).	4052.007
SL	6.5 x 1.2	150	6	106	36	1 pc(s).	4052.011
SL	8 x 1.2	175	7	112	39	1 pc(s).	4052.014
SL	5.5 x 1	25	5	60	21	1 pc(s).	4052.018

For Pozidriv screws

Blade tip	Blade (width x thickness)	Blade length mm	Blade dia. mm	Handle length mm	Handle dia. mm	Packs of	Model No.
PZ 1	–	80	4.5	94	30	1 pc(s).	4052.021
PZ 2	–	100	6	106	36	1 pc(s).	4052.022

For Phillips-head screws

Blade tip	Blade (width x thickness)	Blade length mm	Blade dia. mm	Handle length mm	Handle dia. mm	Packs of	Model No.
PH 1	–	80	4.5	94	30	1 pc(s).	4052.031
PH 2	–	100	6	106	36	1 pc(s).	4052.032
PH 2	–	25	6	60	21	1 pc(s).	4052.038

For multi-tooth screws

Blade tip	Blade (width x thickness)	Blade length mm	Blade dia. mm	Handle length mm	Handle dia. mm	Packs of	Model No.
TX 10	–	100	3.5	86	25	1 pc(s).	4052.053
TX 15	–	100	4	94	30	1 pc(s).	4052.054
TX 20	–	100	5	101	33	1 pc(s).	4052.055
TX 25	–	100	5	106	36	1 pc(s).	4052.056
TX 30	–	115	6	112	39	1 pc(s).	4052.058

Screwdriver set

uninsulated

Multi-part screwdriver set.

Benefits:

- Minimal force required, thanks to ergonomically styled handle
- Handle head with anti-roll protection and clear screw labelling
- Black coated blade tip to preserve precision and accuracy of fit

Material:

- Blade: Chrome-molybdenum-vanadium alloy
- Handle core: Hard plastic
- Handle body: Elastic, highly flexible plastic

Colour:

- Handle: Anthracite and Rittal Power Pink

Approvals:

- TÜV-tested safety

Blade tip	Product-specific scope of supply	Packs of	Model No.
SL 3.5 x 0.6 mm SL 6.5 x 1.2 mm PZ 1 PZ 2 PH 1 PH 2	6-part set	1 pc(s).	4052.200
PH 1 PH 2 TX 15 TX 20 TX 25 TX 30	6-part set	1 pc(s).	4052.201
TX 10 TX 15 TX 20 TX 25 TX 30	5-part set	1 pc(s).	4052.202



Interchangeable screwdriver set

uninsulated

13-piece tool set with comfortable, foldable, lockable handle.

Technical specifications:

- PH 1 - SL 4 x 0.8 mm
- PH 2 - PH 3
- PZ 1 - SL 5 x 0.8 mm
- PZ 2 - SL 6 x 1 mm
- PZ 3 - SL 7 x 1.2 mm
- TX 6 - TX 7
- TX 8 - TX 9
- TX 10 - TX 15
- TX 20 - TX 25
- TX 30 - TX 40
- Hex socket 3 mm - hex socket 4 mm
- Hex socket 5 mm - hex socket 6 mm

Material:

- Blade: Chrome-molybdenum-vanadium alloy
- Handle core: Hard plastic
- Handle body: Elastic, highly flexible plastic

Colour:

- Handle: Anthracite and Rittal Power Pink

Supply includes:

- Combined blade holder: Screwdriver and T handle
- 12 blades each with 2 tips
- Storage box

Blade length mm	Handle length mm	Handle dia. mm	Packs of	Model No.
160	105	39	1 pc(s).	4053.450



Hex wrenches



Hex wrench set

for Allen screws

Hex wrench with optimum, narrow-tolerance hexagonal profiles and precise ballhead geometry. The extra-long design achieves a greater leverage effect.

Benefits:

- Up to 30% more corrosion resistance
- Optimum hardness and elasticity
- Intensive leverage effect
- Special geometry in the critical zone

Technical specifications:

- For hex socket: 1.27 - 1.5 - 2.0 - 2.5 - 3.0 - 3.5 - 4.0 - 4.5 - 5.0 - 5.5 - 6.0 - 7.0 - 8.0 - 9.0 - 10.0 mm

Supply includes:

- 15 hex wrenches
- Storage box

Packs of	Model No.
1 pc(s).	4052.480

Industrial bit for cordless screwdrivers

with long shaft

Precisely manufactured screwdriver with a long shaft for industrial use.

Benefits:

- Maximum hardness and torque values

Technical specifications:

- Tool adaptation E 6.3 (1/4")

Material:

- High-quality special tool steel

For slot-head screws

Blade tip	Blade (width x thickness) mm	Length mm	Blade dia. mm	Packs of	Model No.
SL	3.5 x 0.6	73	6.3	3 pc(s).	4053.002
SL	4 x 0.8	73	6.3	3 pc(s).	4053.003

For Pozidriv screws

Blade tip	Blade (width x thickness)	Length mm	Blade dia. mm	Packs of	Model No.
PZ 1	–	73	6.3	3 pc(s).	4053.011
PZ 2	–	73	6.3	3 pc(s).	4053.012

For Phillips-head screws

Blade tip	Blade (width x thickness)	Length mm	Blade dia. mm	Packs of	Model No.
PH 1	–	73	6.3	3 pc(s).	4053.021
PH 2	–	73	6.3	3 pc(s).	4053.022

For plus/minus

Blade tip	Blade (width x thickness)	Length mm	Blade dia. mm	Packs of	Model No.
Z 1	–	73	6.3	3 pc(s).	4053.031
Z 2	–	73	6.3	3 pc(s).	4053.032

For multi-tooth screws

Blade tip	Blade (width x thickness)	Length mm	Blade dia. mm	Packs of	Model No.
TX 10	–	73	6.3	3 pc(s).	4053.041
TX 15	–	73	6.3	3 pc(s).	4053.042
TX 20	–	73	6.3	3 pc(s).	4053.043
TX 25	–	73	6.3	3 pc(s).	4053.044
TX 27	–	73	6.3	3 pc(s).	4053.045
TX 30	–	73	6.3	3 pc(s).	4053.046
TX 40	–	73	6.3	3 pc(s).	4053.047



Bits and bit holders



Industrial bit set for cordless screwdriver

with long shaft

Precisely manufactured screwdriver with a long shaft for industrial use.

Benefits:

- Robust viewing box
- Secure storage

Technical specifications:

- Tool adaptation E 6.3 (1/4")

Material:

- High-quality special tool steel

Supply includes:

- Set with 6 bits
- Viewing box

Blade tip	Length mm	Packs of	Model No.
SL 3.5 x 0.6 mm SL 4 x 0.8 mm SL 5.5 x 1 mm PH 1 PH 2 PZ 2	73	1 pc(s).	4053.400
TX 10 TX 15 TX 20 TX 25 TX 30 TX 40	73	1 pc(s).	4053.410



Bit set

with bit holder

7-piece bit set with a practical assortment of quality bits with a short shaft and magnetic holder.

Benefits:

- One-handed operation
- Function as auxiliary screwdriver

Technical specifications:

- Tool adaptation C 6.3 (1/4")

Supply includes:

- Set with 6 bits
- Bit holder

Blade tip	Length mm	Packs of	Model No.
TX 25 TX 30 TX 40 PH 1 PH 2 PH 3	25	1 pc(s).	4053.420



Bit holder

with handle, magnetic

Ergonomic, adaptable bit holder with handle.

Benefits:

- Extra-strong magnet for optimum retention force
- Precise concentricity
- Handle for anti-roll protection

Technical specifications:

- Tool adaptation C 6.3 (1/4")
- Tool adaptation E 6.3 (1/4")

Material:

- Handle core: Hard plastic
- Handle body: Elastic, highly flexible plastic

Colour:

- Handle: Anthracite and Rittal Power Pink

Blade length mm	Blade dia. mm	Handle length mm	Handle dia. mm	Packs of	Model No.
100	6.3	101	33	1 pc(s).	4053.300

Bits and bit holders

Bit holder

magnetic

Magnetic holder with hex drive to hold bits securely.

Benefits:

- Extra-strong magnet for optimum retention force
- Precise concentricity

Technical specifications:

- Tool adaptation E 6.3 (1/4")

Material:

- High-quality special tool steel

Blade length mm	Blade dia. mm	Packs of	Model No.
47	6.3	1 pc(s).	4053.310

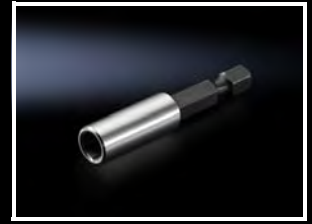

Crimping pliers



Flex crimping tool

for wire end ferrules

For use with wire end ferrules with no insulating collar to DIN 46228, Part 1 and wire end ferrules with insulating collar to DIN 46228, Part 4.

Benefits:

- Front or side accommodation of the wire end ferrule with a rotatable head
- Minimal effort required with large conductor cross-sections
- Uniformly high quality compression
- Releasable ratchet
- Self-adjusting

Material:

- High-quality special tool steel

Surface finish:

- Coated, black, matt

Colour:

- Handle: Anthracite and Rittal Power Pink



Accessories:

- Wire end ferrules, see page 581

For cross-section mm ²	AWG	Direction of cable entry	Compression	Length mm	Design	Packs of	Model No.
0.14 - 10	26 - 8	front and side	Trapezoid crimp	180	Straight	1 pc(s).	4054.030



Crimping pliers

for wire end ferrules

For use with wire end ferrules with no insulating collar to DIN 46228, Part 1 and wire end ferrules with insulating collar to DIN 46228, Part 4.

Benefits:

- Minimal effort required with large conductor cross-sections
- Uniformly high quality compression
- Releasable ratchet
- Self-adjusting

Material:

- High-quality special tool steel

Surface finish:

- Matt, plated

Colour:

- Handle: Anthracite and Rittal Power Pink



Accessories:

- Wire end ferrules, see page 581

For cross-section mm ²	AWG	Direction of cable entry	Compression	Length mm	Design	Packs of	Model No.
0.14 - 10	26 - 8	Side	Square crimp	176	Straight	1 pc(s).	4054.002
0.14 - 10	26 - 8	Side	Hexagonal crimp	176	Straight	1 pc(s).	4054.003

Crimping pliers

Crimping pliers

for wire end ferrules

For use with wire end ferrules with no insulating collar to DIN 46228 Part 1 and wire end ferrules with insulating collar to DIN 46228 Part 4.

Benefits:

- Minimal effort required with large conductor cross-sections
- Uniformly high quality compression
- Marked die stations for precise machining of the relevant cross-sections
- Releasable ratchet

Material:

- High-quality special tool steel

Surface finish:

- Matt, plated

Colour:

- Handle: Anthracite and Rittal Power Pink

Accessories:

- Wire end ferrules, see page 581

For cross-section mm ²	AWG	Direction of cable entry	Compression	Length mm	Design	Packs of	Model No.
0.25 - 6	24 - 10	Side	Trapezoid crimp	198	Angled	1 pc(s).	4054.000
0.5 - 6	22 - 10	Front	Square crimp	198	Angled	1 pc(s).	4054.001
10 - 25	8 - 4	Side	WM crimp	256	Straight	1 pc(s).	4054.004
35 - 50	2 - 1	Side	WM crimp	256	Straight	1 pc(s).	4054.008

Crimping pliers

for crimp tab terminals

For use with non-insulated crimp tab terminals.

Benefits:

- Releasable ratchet
- Marked die stations for precise machining of the relevant cross-sections

Material:

- High-quality special tool steel

Surface finish:

- Matt, plated

Colour:

- Handle: Anthracite and Rittal Power Pink

For cross-section mm ²	AWG	Compression	Length mm	Design	Packs of	Model No.
0.1 - 1.5	26 - 16	B-crimp	198	Angled	1 pc(s).	4054.080
0.5 - 6	22 - 10	B-crimp	256	Straight	1 pc(s).	4054.081



Crimping pliers



Crimping pliers

for ring terminals

For use with non-insulated ring terminals.

Benefits:

- Releasable ratchet
- Optimised lever transmission means that only minimal actuator forces are required, even with large cross-sections

Material:

- High-quality special tool steel

Surface finish:

- Matt, plated

Colour:

- Handle: Anthracite and Rittal Power Pink

For cross-section mm ²	AWG	Compression	Length mm	Design	Packs of	Model No.
0.5 - 2.5	20 - 14	Indent crimp	198	Angled	1 pc(s).	4054.020
0.35 - 6	22 - 10	Indent crimp	198	Angled	1 pc(s).	4054.021
4 - 10	12 - 8	Double-indent crimp	256	Straight	1 pc(s).	4054.023
10 - 25	8 - 4	Indent crimp	256	Straight	1 pc(s).	4054.024

Crimping pliers

Crimping pliers

for ring terminals

For use with insulated ring terminals and connectors.

Benefits:

- Clear allocation of cross-sections, thanks to colour coding on the dies
- Releasable ratchet
- Releases as soon as the required pressure is reached, to prevent underpressing

Material:

- High-quality special tool steel

Surface finish:

- Matt, plated

Colour:

- Handle: Anthracite and Rittal Power Pink

For cross-section mm ²	AWG	Compression	Length mm	Design	Packs of	Model No.
0.75 - 2.5	22 - 14	Oval crimp	198	Angled	1 pc(s).	4054.140
0.75 - 6	22 - 10	Oval crimp	256	Straight	1 pc(s).	4054.141



Wire end ferrules



Wire end ferrules

on a reel

With plastic collar.

Technical specifications:

- Heat-resistant to 105 °C

Material:

- E-Cu, galvanic tin-plated
- Plastic collar: Polypropylene

Note:

- UL-certified in conjunction with the relevant tools, such as crimping machines.

Standards:

- AEH DIN 46228

Approvals:

- Available on the Internet

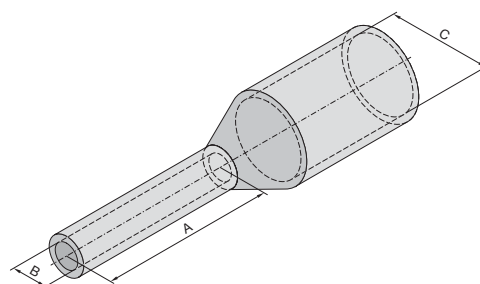

A: Length
B: Cross-section
C: Internal diameter

For cross-section 0.5 mm², delivery form: on a reel

Model No.	4051.540	4051.597	4051.548	4050.746	4051.536	4051.598
Packs of	4000 pc(s).	5000 pc(s).	4000 pc(s).	5000 pc(s).	4000 pc(s).	5000 pc(s).
For	Crimping machine RC Crimping machine R8	Crimping machine RC Crimping machine R8 Crimping machine R8 E	Crimping machine RC Crimping machine R8	Crimping machine RC Crimping machine R8 Crimping machine R8 E	Crimping machine RC	Crimping machine RC
For cross-section mm ²	0.5	0.5	0.5	0.5	0.5	0.5
AWG	20	20	20	20	20	20
Length mm	8	8	8	8	10	10
Internal diameter mm	2.9	2.6	2.9	2.6	2.9	2.6
Colour	Orange	Orange	White	White	Orange	Orange
DIN colour code	–	–	■	■	–	–
Rittal colour code	■	■	–	–	■	■
Multiple colour codes supported	■	–	■	–	■	–

For cross-section 0.5 - 0.75 mm², delivery form: on a reel

Model No.	4051.544	4051.695	4051.549	4050.747	4051.541	4051.599
Packs of	4000 pc(s).	5000 pc(s).	4000 pc(s).	5000 pc(s).	4000 pc(s).	5000 pc(s).
For	Crimping machine RC	Crimping machine RC	Crimping machine RC Crimping machine R8	Crimping machine RC Crimping machine R8 Crimping machine R8 E	Crimping machine RC Crimping machine R8	Crimping machine RC Crimping machine R8 Crimping machine R8 E
For cross-section mm ²	0.5	0.5	0.75	0.75	0.75	0.75
AWG	20	20	18	18	18	18
Length mm	10	10	8	8	8	8
Internal diameter mm	2.9	2.6	3.4	2.8	3.4	2.8
Colour	White	White	Grey	Grey	White	White
DIN colour code	■	■	■	■	–	–
Rittal colour code	–	–	–	–	■	■
Multiple colour codes supported	■	–	■	–	■	–

Wire end ferrules

For cross-section 0.75 mm², delivery form: on a reel

Model No.	4051.545	4051.696	4051.537	4051.600
Packs of	4000 pc(s).	5000 pc(s).	4000 pc(s).	5000 pc(s).
For	Crimping machine RC	Crimping machine RC	Crimping machine RC	Crimping machine RC
For cross-section mm ²	0.75	0.75	0.75	0.75
AWG	18	18	18	18
Length mm	10	10	10	10
Internal diameter mm	3.4	2.8	3.4	2.8
Colour	Grey	Grey	White	White
DIN colour code	■	■	–	–
Rittal colour code	–	–	■	■
Multiple colour codes supported	■	–	■	–

For cross-section 1 mm², delivery form: on a reel

Model No.	4051.542	4051.601	4051.550	4050.748	4051.538	4051.602
Packs of	4000 pc(s).	5000 pc(s).	4000 pc(s).	5000 pc(s).	4000 pc(s).	5000 pc(s).
For	Crimping machine RC Crimping machine R8	Crimping machine RC Crimping machine R8 Crimping machine R8 E	Crimping machine RC Crimping machine R8	Crimping machine RC Crimping machine R8 Crimping machine R8 E	Crimping machine RC	Crimping machine RC
For cross-section mm ²	1	1	1	1	1	1
AWG	18	18	18	18	18	18
Length mm	8	8	8	8	10	10
Internal diameter mm	3.5	3	3.5	3	3.5	3
Colour	Yellow	Yellow	Red	Red	Yellow	Yellow
DIN colour code	–	–	■	■	–	–
Rittal colour code	■	■	–	–	■	■
Multiple colour codes supported	■	–	■	–	■	–

For cross-section 1 - 1.5 mm², delivery form: on a reel

Model No.	4051.546	4051.697	4051.543	4051.603	4051.551	4050.749
Packs of	4000 pc(s).	5000 pc(s).	4000 pc(s).	5000 pc(s).	4000 pc(s).	5000 pc(s).
For	Crimping machine RC	Crimping machine RC	Crimping machine RC Crimping machine R8	Crimping machine RC Crimping machine R8 Crimping machine R8 E	Crimping machine RC Crimping machine R8	Crimping machine RC Crimping machine R8 Crimping machine R8 E
For cross-section mm ²	1	1	1.5	1.5	1.5	1.5
AWG	18	18	16	16	16	16
Length mm	10	10	8	8	8	8
Internal diameter mm	3.5	3	4	3.5	4	3.5
Colour	Red	Red	Red	Red	Black	Black
DIN colour code	■	■	–	–	■	■
Rittal colour code	–	–	■	■	–	–
Multiple colour codes supported	■	–	■	–	■	–

Wire end ferrules

For cross-section 1.5 mm², delivery form: on a reel

Model No.	4051.539	4051.604	4051.547	4051.698
Packs of	4000 pc(s).	5000 pc(s).	4000 pc(s).	5000 pc(s).
For	Crimping machine RC	Crimping machine RC	Crimping machine RC	Crimping machine RC
For cross-section mm ²	1.5	1.5	1.5	1.5
AWG	16	16	16	16
Length mm	10	10	10	10
Internal diameter mm	4	3.5	4	3.5
Colour	Red	Red	Black	Black
DIN colour code	–	–	■	■
Rittal colour code	■	■	–	–
Multiple colour codes supported	■	–	■	–

For cross-section 2.5 mm², delivery form: on a reel

Model No.	4050.750	4051.605
Packs of	3000 pc(s).	3000 pc(s).
For	Crimping machine RC Crimping machine R8 Crimping machine R8 E	Crimping machine RC
For cross-section mm ²	2.5	2.5
AWG	14	14
Length mm	8	10
Internal diameter mm	4.2	4.2
Colour	Blue	Blue
DIN colour code	■	■
Rittal colour code	■	■
Multiple colour codes supported	■	■

Wire end ferrules

Wire end ferrules

loose

With plastic collar.

Technical specifications:

- Heat-resistant to 105 °C

Material:

- E-Cu, galvanic tin-plated
- Plastic collar: Polypropylene

Note:

- UL-certified in conjunction with the relevant tools, such as crimping machines.

Standards:

- AEH DIN 46228

Approvals:

- Available on the Internet

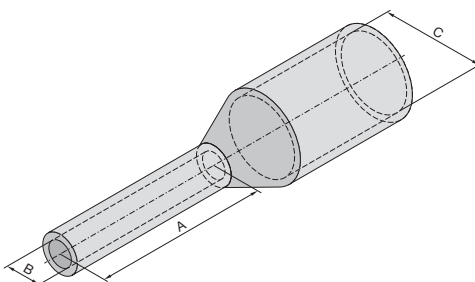

A: Length
B: Cross-section
C: Internal diameter



For cross-section 0.14 - 0.5 mm², delivery form: loose

Model No.	4050.752	4050.754	4050.757	4050.760	4050.730	4050.742	4050.761
Packs of	500 pc(s).	500 pc(s).	500 pc(s).	500 pc(s).	500 pc(s).	500 pc(s).	500 pc(s).
For	manual wire processing	manual wire processing	manual wire processing	Crimping machine L8 manual wire processing	Crimping machine L8 manual wire processing	Crimping machine L8 manual wire processing	manual wire processing
For cross-section mm ²	0.14	0.25	0.34	0.5	0.5	0.5	0.5
AWG	26	24	22	20	20	20	20
Length mm	8	8	8	8	8	8	10
Internal diameter mm	1.5	1.8	2	2.6	2.6	2.9	2.6
Colour	Grey	Light blue	Turquoise	Orange	White	White	Orange
DIN colour code	–	–	–	–	■	■	–
Rittal colour code	■	■	■	■	–	–	■

For cross-section 0.75 - 1 mm², delivery form: loose

Model No.	4050.731	4050.743	4050.764	4050.766	4050.769	4050.732	4050.744
Packs of	500 pc(s).	500 pc(s).	500 pc(s).	500 pc(s).	500 pc(s).	500 pc(s).	500 pc(s).
For	Crimping machine L8 manual wire processing	Crimping machine L8 manual wire processing	Crimping machine L8 manual wire processing	manual wire processing	Crimping machine L8 manual wire processing	Crimping machine L8 manual wire processing	Crimping machine L8 manual wire processing
For cross-section mm ²	0.75	0.75	0.75	0.75	1	1	1
AWG	18	18	18	18	18	18	18
Length mm	8	8	8	10	8	8	8
Internal diameter mm	2.8	3.4	2.8	2.8	3	3	3.5
Colour	Grey	Grey	White	White	Yellow	Red	Red
DIN colour code	■	■	–	–	–	■	■
Rittal colour code	–	–	■	■	■	–	–

Wire end ferrules

For cross-section 1 - 2.5 mm², delivery form: loose

Model No.	4050.770	4050.773	4050.733	4050.745	4050.774	4050.734	4050.779
Packs of	500 pc(s).	500 pc(s).	500 pc(s).	500 pc(s).	500 pc(s).	500 pc(s).	500 pc(s).
For	manual wire processing	Crimping machine L8 manual wire processing	Crimping machine L8 manual wire processing	Crimping machine L8 manual wire processing	manual wire processing	Crimping machine L8 manual wire processing	manual wire processing
For cross-section mm ²	1	1.5	1.5	1.5	1.5	2.5	2.5
AWG	18	16	16	16	16	14	14
Length mm	10	8	8	8	10	8	10
Internal diameter mm	3	3.5	3.5	4	3.5	4.2	4.2
Colour	Yellow	Red	Black	Black	Red	Blue	Blue
DIN colour code	-	-	■	■	-	■	-
Rittal colour code	■	■	-	-	■	■	■

For cross-section 4 - 6 mm², delivery form: loose

Model No.	4050.782	4050.735	4050.783	4050.736	4050.785
Packs of	500 pc(s).	500 pc(s).	500 pc(s).	100 pc(s).	100 pc(s).
For	manual wire processing	manual wire processing	manual wire processing	manual wire processing	manual wire processing
For cross-section mm ²	4	4	4	6	6
AWG	12	12	12	10	10
Length mm	8	10	12	12	12
Internal diameter mm	4.8	4.8	4.8	6.3	6.3
Colour	Grey	Grey	Grey	Yellow	Black
DIN colour code	-	-	■	■	-
Rittal colour code	■	■	-	-	■

For cross-section 0.5 - 1 mm², delivery form: loose (10 packs of 100)

Model No.	4051.638	4050.737	4051.641	4050.738	4051.644	4050.739
Packs of	1000 pc(s).	1000 pc(s).	1000 pc(s).	1000 pc(s).	1000 pc(s).	1000 pc(s).
For	manual wire processing	manual wire processing	manual wire processing	manual wire processing	manual wire processing	manual wire processing
For cross-section mm ²	0.5	0.5	0.75	0.75	1	1
AWG	20	20	18	18	18	18
Length mm	10	12	10	12	10	12
Internal diameter mm	2.6	2.6	2.8	2.8	3	3
Colour	White	White	Grey	Grey	Red	Red
DIN colour code	■	■	■	■	■	■
Rittal colour code	-	-	-	-	-	-

For cross-section 1.5 - 2.5 mm², delivery form: loose (10 packs of 100)

Model No.	4051.647	4050.740	4051.525	4050.741
Packs of	1000 pc(s).	1000 pc(s).	1000 pc(s).	1000 pc(s).
For	manual wire processing	manual wire processing	manual wire processing	manual wire processing
For cross-section mm ²	1.5	1.5	2.5	2.5
AWG	16	16	14	14
Length mm	10	12	10	12
Internal diameter mm	3.5	3.5	4.2	4.2
Colour	Black	Black	Blue	Blue
DIN colour code	■	■	■	■
Rittal colour code	-	-	-	-

Insulation stripping tools

Wire stripper

For stripping cables and conductors. Self-adjusting, with ergonomically styled handle, replaceable insulation stripping blade.

Benefits:

- Flexible end stop for the insulation stripping length
- Practical integrated wire cutter
- Automatic adjustment mechanism for a wide range of insulations and conductor diameters
- Dies compatible with all types of pliers, may be replaced in a few actions
- Two-component handle with anti-slip soft zone

Colour:

- Handle: Anthracite and Rittal Power Pink



Accessories:

- Spare blades can be found on the Internet

For cross-section mm ²	AWG	Length mm	Design	Note	Packs of	Model No.
0.02 - 10	34 - 8	191	-	-	1 pc(s).	4054.300
0.02 - 10	34 - 8	168	Angled	-	1 pc(s).	4054.315
0.1 - 4	28 - 12	191	-	Also suitable for rubber and silicone insulation	1 pc(s).	4054.310
4 - 16	12 - 5	191	-	-	1 pc(s).	4054.305

Stripping tool

for cables Ø 2.5 - 11 mm

For stripping installation cables and wires.

Colour:

- Handle: Anthracite and Rittal Power Pink

For cable diameters mm	Length mm	Packs of	Model No.
2.5 - 11	90.5	1 pc(s).	4054.400



Accessories:

- Spare blades can be found on the Internet

Stripping tool

for cables Ø 8 - 13 mm

For stripping single- and multi-wire signal, pilot and fibreglass cables.

Colour:

- Handle: Anthracite and Rittal Power Pink

For cable diameters mm	Length mm	Packs of	Model No.
8 - 13	125	1 pc(s).	4054.405



Insulation stripping tools



Stripping tool

for cables Ø 4.5 - 40 mm

For stripping cables. Vertically hinged blade for creating round, longitudinal and spiral cuts.

Colour:

- Handle: Anthracite and Rittal Power Pink

For cable diameters mm	Length mm	Packs of	Model No.
4.5 - 40	167	1 pc(s).	4054.410



Accessories:

- Spare blades can be found on the Internet

Side cutter

For copper and aluminium conductors.

Benefits:

- Guarantees long-term stable cutting performance and a clean cut
- Ergonomically styled handles for fatigue-free, non-slip working

Material:

- High-quality special tool steel

Surface finish:

- Matt, plated

Colour:

- Handle: Anthracite and Rittal Power Pink

Standards:

- Isolation protection 1000 V
- VDE

For cable diameters mm	Length mm	Design	Packs of	Model No.
0.2 - 11	160	Straight	1 pc(s).	4054.600



Electronic side cutter

With pointed head, 21° angled blades and small chamfer.

Benefits:

- Even, smooth-running opening with opening spring
- Ergonomically styled handles
- Box-joint for permanent stability and optimum force progression

Material:

- High-quality special tool steel

Surface finish:

- Polished, oiled

Colour:

- Handle: Anthracite and Rittal Power Pink

Length mm	Packs of	Model No.
115	1 pc(s).	4054.750

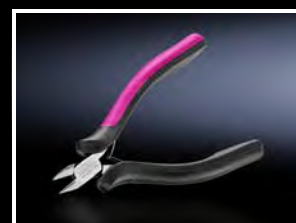

Cable cutter

For copper and aluminium conductors.

Benefits:

- Ergonomically styled handles for fatigue-free, non-slip working

Material:

- High-quality special tool steel

Colour:

- Handle: Anthracite and Rittal Power Pink

Standards:

- Isolation protection 1000 V
- VDE

For cross-section mm ²	For cable diameters mm	Length mm	Design	Packs of	Model No.
0.5 - 35	12	160	Straight	1 pc(s).	4054.650
0.5 - 50	18	180	Angled	1 pc(s).	4054.660



Cutting tools



Electrician's scissors

For cutting copper, aluminium, Kevlar and plastic.

Benefits:

- High cutting performance thanks to micro-serration in the cutting zone
- Ergonomically styled handles
- Two-component handle with anti-slip soft zone
- Adjustable screw joint

Material:

- High-quality special tool steel

Surface finish:

- Brushed

Colour:

- Handle: Anthracite and Rittal Power Pink

For cable diameters mm	Length mm	Packs of	Model No.
0.1 - 3.7	160	1 pc(s).	4054.700



Cross member cutter

To create openings by cutting the cross members in compartment side panels and compartment dividers for VX enclosures and for fuse-switch-disconnector enclosures.

Benefits:

- Cutting of materials without deformation
- Clean edge cuts, no reworking of the cut section required
- Easy to use
- Ergonomically styled handles for fatigue-free, non-slip working

Material:

- Tool body: Special tool steel, rolled, oil-hardened

Colour:

- Handle: Anthracite and Rittal Power Pink

Supply includes:

- Cross member cutter including swarf deflector

To fit Model No.	Length mm	Design	Packs of	Model No.
9683.006/9683.008/ 9683.016/9683.018/ 9683.036/9683.038/ 9680.005/9680.025/ 9680.207/9680.227/ 9683.406/9683.408/ 9683.426/9683.428/ 9683.444/9683.446/ 9683.448/9683.464/ 9683.466/9683.468/ 9683.484/9683.486/ 9683.488	280	Straight	1 pc(s).	4054.870

Combination pliers

Length mm	Packs of	Model No.
180	1 pc(s).	4054.800

With serrated gripping surface and integral ring spanner M8 to M10.

Benefits:

- Ergonomically styled handles for fatigue-free, non-slip working
- Favourable transmission ratios for good holding and cutting performance
- Minimal force required

Material:

- High-quality special tool steel

Surface finish:

- Matt, plated

Colour:

- Handle: Anthracite and Rittal Power Pink

Standards:

- Isolation protection 1000 V
- VDE



Needle-nose pliers

Length mm	Packs of	Model No.
200	1 pc(s).	4054.850

With serrated gripping surface.

Benefits:

- Ergonomically styled handles for fatigue-free, non-slip working

Material:

- High-quality special tool steel

Surface finish:

- Matt, plated

Colour:

- Handle: Anthracite and Rittal Power Pink

Standards:

- Isolation protection 1000 V
- VDE



Electronic needle-nose pliers

Length mm	Packs of	Model No.
120	1 pc(s).	4054.860

With smooth gripping surface.

Benefits:

- Ergonomically styled handles for fatigue-free, non-slip working
- Even, smooth-running opening with opening spring

Material:

- High-quality special tool steel

Surface finish:

- Matt, plated

Colour:

- Handle: Anthracite and Rittal Power Pink

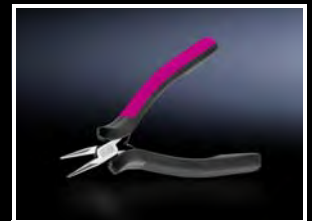

Pliers



Slip-joint pliers

For width across flats 10 - 36 mm.

Benefits:

- Ergonomically styled handles for fatigue-free, non-slip working
- Smooth cheeks avoid the usual damage caused by wrenches and pipe wrenches on screws/nuts
- QuickSnap ratcheting for fast adjustment to the workpiece with no push-button
- Robust box-joint

Material:

- High-quality special tool steel

Surface finish:

- Matt, plated

Colour:

- Handle: Anthracite and Rittal Power Pink

Length mm	Packs of	Model No.
260	1 pc(s).	4054.900

Maximum data quality

Streamline your workflow with software-based engineering

This enclosure is available in duplicate – real and digital.

The maximum data quality of the enclosures creates greater flexibility with configuration, manufacturing and assembly. What's more, the digital twin allows the planning, ordering, processing and much more to be carried out by the person who knows your company the best: you.

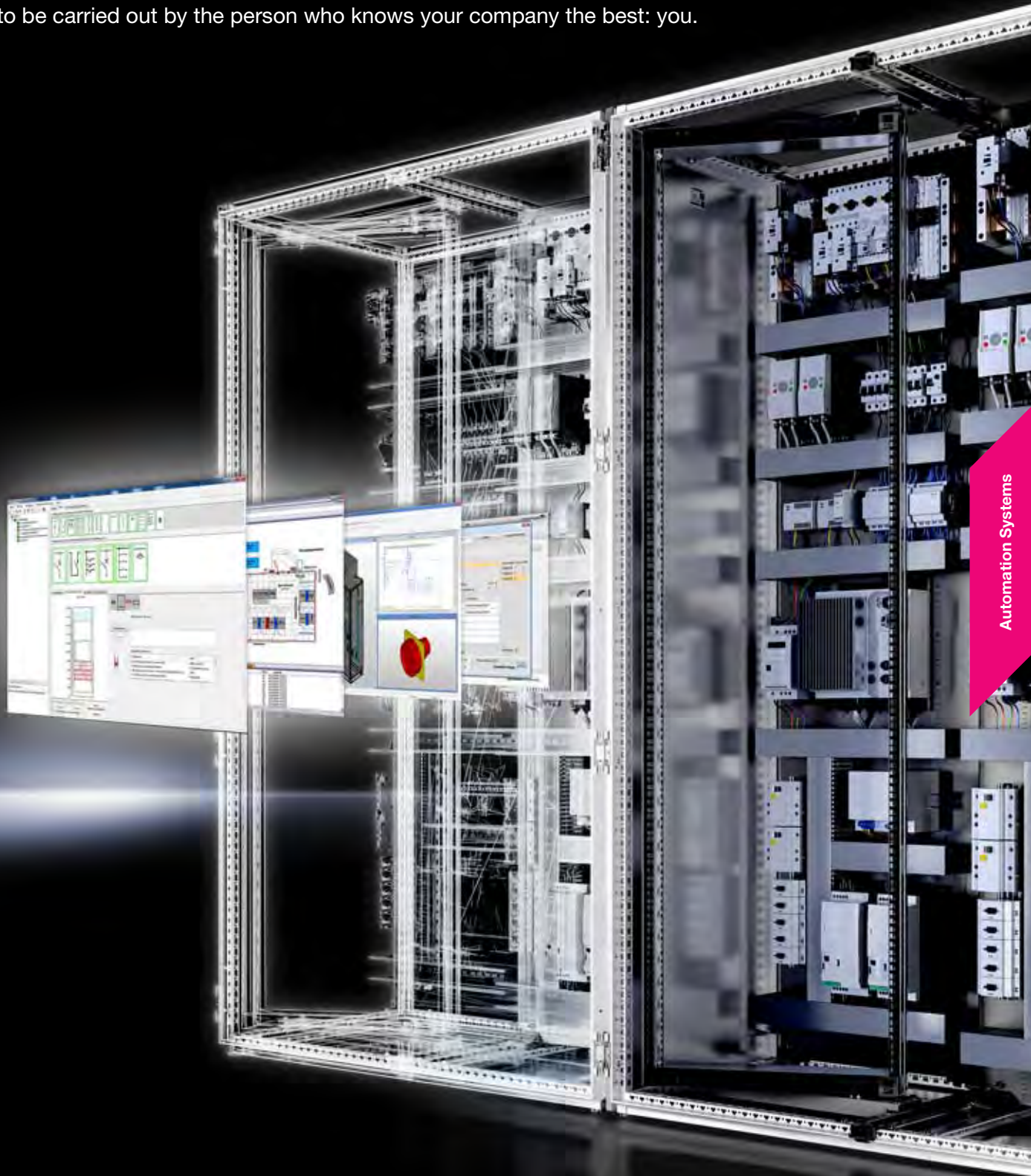

Mechanical tools



Deburring blade

Universal deburrer, for deburring holes and edges.

Design:

- Steel blade may be clamped in an axial or radial direction as required
- Steel blade brushed on both sides

Benefits:

- Blade automatically assumes the optimum position
- Length of blade support is adjustable
- Easy to use
- Effortless deburring
- Ergonomically styled handle

Material:

- Handle core: Hard plastic
- Handle body: Elastic, highly flexible plastic
- Blade holder: Steel
- Blade: Hardened steel blade, with PVD TiN (titanium nitride) coating

Colour:

- Handle: Black and red

Supply includes:

- Handle
- Blade holder
- Steel blade

Handle length mm	Handle dia. mm	Packs of	Model No.
110	28	1 pc(s).	4050.722



Accessories:

- Steel blade, see page 590

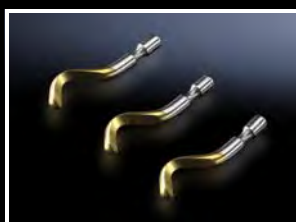

Steel blade

for deburring blade

Spare blade for deburrer. Rotating 360° blades for deburring.

Design:

- Steel blade brushed on both sides

Material:

- Hardened steel blade, with PVD TiN (titanium nitride) coating

To fit Model No.	Blade length mm	Blade dia. mm	Packs of	Model No.
4050.722	23	3	10 pc(s).	4050.723



Also required:

- Deburring blade, see page 590



Multitool

for AX, VX

Multifunctional tool. Ideal for handling and mounting AX enclosures and VX doors.

Functions:

- Cutting of packaging (tapes and foil)
- Enclosure key (double-bit)
- Installation and dismantling of hinge pins with AX enclosures
- Temporary door stay for AX enclosures
- Safe installation and removal of VX doors
- Magnet for securing drawings and attaching to enclosure surfaces
- Bottle opener function

Technical specifications:

- Load capacity max. 40 kg (lift door)

Material:

- Door lift function: Stainless steel
- Double-bit: Die-cast zinc
- Mounting aid for hinge pins: Die-cast zinc
- Door stay: Die-cast zinc
- Blade: Stainless steel blade
- Handle: Plastic

Colour:

- Handle: Anthracite and Rittal Power Pink

Packs of	Model No.
1 pc(s).	4052.000

Lifting aid for mounting plate for AX

Lifting tool to support the assembly process of mounting plates for AX enclosures. Allows easy location and positioning of the mounting plate without risk of injury.

Benefits:

- Easy location of populated mounting plates
- Tool-free mounting on the mounting plate
- Loop function for crane use
- No risk of fingers or hands becoming trapped

Technical specifications:

- Load capacity max. 40 kg per cable

Material:

- Lifting rope and loop: Steel
- Handle: Plastic
- Mounting plate adaptor: Die-cast zinc

Colour:

- Handle: Anthracite and Rittal Power pink

Supply includes:

- 1 set $\hat{=}$ 4 lifting aids

Packs of	Model No.
1 pc(s).	4050.140



Drilling template for AX

For precise positioning and support when drilling extra holes in AX enclosures. Designed for steel and stainless steel enclosures.

Applications:

- Universal bracket 2373.000
- Swing frame installation kit 2034.010
- Door stay 1485.100
- 180° hinges 2449.010

Benefits:

- Protects the edge of the enclosure
- No measurement or marking out required
- Avoids scratches and damage to the enclosure surface

Technical specifications:

- For holes \varnothing 4.5 / 5.5 / 6.5 mm

Material:

- Hard plastic

Colour:

- RAL 9005

Width mm	Height mm	Depth mm	Packs of	Model No.
96	30	45	1 pc(s).	4052.500



Hole punching tools

Hydraulic punches

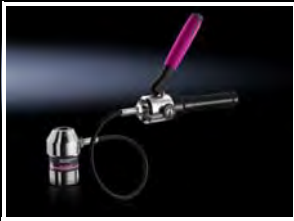

Manual hydraulic punch

For punching round, square and rectangular cut-outs.

Benefits:

- Extend tool life with a built-in overpressure valve

Punching capacity:

- Round punch up to Ø 82 mm
- Square punch up to 68 x 68 mm
- Rectangular punch up to 46 x 86 mm
- Punching force 75 kN
- Max. operating pressure 680 bar/9850 psi

Material:

- Aluminium

Supply includes:

- Manual hydraulic punch
- Hydraulic screw Ø 19 mm
- Hydraulic screw Ø 9.5 / 19 mm
- HSS pilot drill Ø 11 mm
- Spacer sleeve set (3-part)
- Plastic case

Design	Packs of	Model No.
Straight	1 pc(s).	4055.000
With 90° angled and 360° rotating cylinder head	1 pc(s).	4055.010
Flexible, with hydraulic hose and separate cylinder	1 pc(s).	4055.020

Electric hydraulic punch

For punching round, square and rectangular cut-outs.

Benefits:

- Extend tool life with a built-in overpressure valve
- High-performance drive motor with ergonomically styled handle
- Slide in the battery packs from two sides to balance the weight

Punching capacity:

- Round punch up to Ø 82 mm
- Square punch up to 68 x 68 mm
- Punching force 75 kN
- Max. operating pressure 680 bar/9850 psi

Material:

- Aluminium

Supply includes:

- Electric hydraulic punch with 2 NiMH batteries, 18 V
- Charging device 18 - 28 V
- Hydraulic screw Ø 9.5 / 19 mm
- Hydraulic screw Ø 19 mm
- Spacer sleeve set (3-part)
- HSS pilot drill Ø 11 mm
- Plastic case

Packs of	Model No.
1 pc(s).	4055.041

Hole punching tools

Hydraulic punches

Manual hydraulic punch set, M16 - M63

Manual hydraulic punch in a practical set with hole punches for sheet steel. Maximum machinable material thickness 2 or 3 mm.

Benefits:

- Extend tool life with a built-in overpressure valve

Supply includes:

- Manual hydraulic punch, straight
- 7 splitter hole punches, triple splitting
- Hydraulic screw Ø 19 mm
- Hydraulic screw Ø 9.5 / 19 mm
- HSS pilot drill Ø 10 mm
- Spacer sleeve set (3-part)
- Plastic case

For threads	Ø punch mm	Packs of	Model No.
M16	16.2	1 pc(s).	4055.070
M20	20.4		
M25	25.4		
M32	32.5		
M40	40.5		
M50	50.5		
M63	63.5		



Manual hydraulic punch set, M16 - M40

Manual hydraulic punch in a practical set with hole punches for sheet steel. Maximum machinable material thickness 2 or 3 mm.

Design:

- With 90° angled and 360° rotating cylinder head

Benefits:

- Extend tool life with a built-in overpressure valve

Supply includes:

- Manual hydraulic punch
- 5 splitter hole punches, triple splitting
- Hydraulic screw Ø 19 mm
- Hydraulic screw Ø 9.5 / 19 mm
- HSS pilot drill Ø 10 mm
- Spacer sleeve set (3-part)
- Plastic case

For threads	Ø punch mm	Packs of	Model No.
M16	16.2	1 pc(s).	4055.080
M20	20.4		
M25	25.4		
M32	32.5		
M40	40.5		



Manual hydraulic punch set, PG 9 - PG 48

Manual hydraulic punch in a practical set with hole punches for sheet steel. Maximum machinable material thickness 2 or 3 mm.

Design:

- With 90° angled and 360° rotating cylinder head

Benefits:

- Extend tool life with a built-in overpressure valve

Supply includes:

- Manual hydraulic punch
- 9 splitter hole punches, triple splitting
- Hydraulic screw Ø 19 mm
- Hydraulic screw Ø 9.5 / 19 mm
- HSS pilot drill Ø 10 mm
- Spacer sleeve set (3-part)
- Plastic case

For PG	Ø punch mm	Packs of	Model No.
9	15.2	1 pc(s).	4055.085
11	18.6		
13	20.4		
16	22.5		
21	28.3		
29	37		
36	47		
42	54		
48	60		



Hole punching tools

Hole punches



Hole punch, round

for sheet steel

For punching round cut-outs. The hole punch is operated with a wrench or hydraulic punch.

Design:

- With 3 cutting points

Supply includes:

- Female dies
- Male dies
- Tension screw without ball bearing

Note:

- When operating with wrenches, tension screws with ball bearings should be used
- Other sizes, see splitter hole punch, round, stainless steel



Accessories:

- Tension screw, see page 602
- Hydraulic tension screw, see page 603

For threads	For PG	Ø punch mm	Tension screw (Ø x L) mm	Tension screw with ball bearing Model No.	Hydraulic tension screw Ø mm	Hydraulic tension screw Model No.	Maximum machinable material thickness, sheet steel mm	Packs of	Model No.
M12	7	12.7	9.5 x 50	4055.631	9.5/19	4055.661	2	1 pc(s).	4055.212
-	9	15.2	9.5 x 50	4055.631	9.5/19	4055.661	2	1 pc(s).	4055.215
M16	-	16.2	9.5 x 50	4055.631	9.5/19	4055.661	2	1 pc(s).	4055.216
-	11	18.6	9.5 x 50	4055.631	9.5/19	4055.661	2	1 pc(s).	4055.218
M20	13	20.4	9.5 x 50	4055.631	9.5/19	4055.661	2	1 pc(s).	4055.220
-	16	22.5	9.5 x 50	4055.631	9.5/19	4055.661	2	1 pc(s).	4055.222
M25	-	25.4	9.5 x 50	4055.631	9.5/19	4055.661	2	1 pc(s).	4055.225
-	21	28.3	9.5 x 50	4055.631	9.5/19	4055.661	2	1 pc(s).	4055.228
M32	-	32.5	9.5 x 50	4055.631	9.5/19	4055.661	2	1 pc(s).	4055.232
-	29	37	19 x 55	4055.633	19	4055.663	3	1 pc(s).	4055.237
M40	-	40.5	19 x 55	4055.633	19	4055.663	3	1 pc(s).	4055.240
-	36	47	19 x 75	4055.634	19	4055.663	3	1 pc(s).	4055.247
M50	-	50.5	19 x 75	4055.634	19	4055.663	3	1 pc(s).	4055.250
-	42	54	19 x 75	4055.634	19	4055.663	3	1 pc(s).	4055.254
-	48	60	19 x 75	4055.634	19	4055.663	3	1 pc(s).	4055.260
M63	-	63.5	19 x 75	4055.634	19	4055.663	3	1 pc(s).	4055.263

Hole punch set, metric

for sheet steel

For punching round cut-outs. The hole punch is operated with a wrench or hydraulic punch.

Design:

- With 3 cutting points

Supply includes:

- 5 female dies
- 5 male dies
- Plastic case

Note:

- When operating with wrenches, tension screws with ball bearings should be used

Accessories:

- Tension screw, see page 602
- Hydraulic tension screw, see page 603

For threads	Ø punch mm	Tension screw with ball bearing Model No.	Hydraulic tension screw Model No.	Maximum machinable material thickness, sheet steel mm	Packs of	Model No.
M16	16.2	4055.631	4055.661	2	1 pc(s).	4055.480
M20	20.4	4055.631	4055.661	2		
M25	25.4	4055.631	4055.661	2		
M32	32.5	4055.631	4055.661	2		
M40	40.5	4055.633	4055.663	3		

Hole punch set, PG

for sheet steel

For punching round cut-outs. The hole punch is operated with a wrench or hydraulic punch.

Design:

- With 3 cutting points

Supply includes:

- 5 female dies
- 5 male dies
- 2 tension screws with ball bearing Ø 9.5 x 50 mm
- HSS pilot drill Ø 11 mm
- 1 tube of lubricant paste
- Plastic case

Note:

- When operating with wrenches, tension screws with ball bearings should be used

Accessories:

- Hydraulic tension screw, see page 603

For PG	Ø punch mm	Hydraulic tension screw Model No.	Maximum machinable material thickness, sheet steel mm	Packs of	Model No.
9	15.2	4055.661	2	1 pc(s).	4055.481
11	18.6				
13	20.4				
16	22.5				
21	28.3				



Hole punching tools

Hole punches



Splitter hole punch, round

for sheet steel, with triple splitting

For punching round cut-outs. The hole punch is operated with a wrench or hydraulic punch.

Design:

- With triple splitting

Supply includes:

- Female dies
- Male dies

Note:

- When operating with wrenches, tension screws with ball bearings should be used
- Other sizes, see splitter hole punch, round, stainless steel



Accessories:

- Tension screw, see page 602
- Hydraulic tension screw, see page 603

For threads	For PG	Ø punch mm	Tension screw (Ø x L) mm	Tension screw with ball bearing Model No.	Hydraulic tension screw Ø mm	Hydraulic tension screw Model No.	Maximum machinable material thickness, sheet steel mm	Packs of	Model No.
M12	–	12.5	6 x 40	4055.630	6/19	4055.660	1.5	1 pc(s).	4055.512
–	9	15.2	9.5 x 50	4055.631	9.5/19	4055.661	2	1 pc(s).	4055.515
M16	–	16.2	9.5 x 50	4055.631	9.5/19	4055.661	2	1 pc(s).	4055.516
–	11	18.6	9.5 x 50	4055.631	9.5/19	4055.661	2	1 pc(s).	4055.518
M20	13	20.4	9.5 x 50	4055.631	9.5/19	4055.661	2	1 pc(s).	4055.520
–	16	22.5	9.5 x 50	4055.631	9.5/19	4055.661	2	1 pc(s).	4055.522
M25	–	25.4	9.5 x 50	4055.631	9.5/19	4055.661	2	1 pc(s).	4055.525
–	21	28.3	9.5 x 50	4055.631	9.5/19	4055.661	2	1 pc(s).	4055.528
M32	–	32.5	19 x 55	4055.633	19	4055.663	3	1 pc(s).	4055.532
–	29	37	19 x 55	4055.633	19	4055.663	3	1 pc(s).	4055.537
M40	–	40.5	19 x 75	4055.634	19	4055.663	3	1 pc(s).	4055.540
–	36	47	19 x 75	4055.634	19	4055.663	3	1 pc(s).	4055.547
M50	–	50.5	19 x 75	4055.634	19	4055.663	3	1 pc(s).	4055.550
–	42	54	19 x 75	4055.634	19	4055.663	3	1 pc(s).	4055.554
–	48	60	19 x 75	4055.634	19	4055.663	3	1 pc(s).	4055.560
M63	–	63.5	19 x 75	4055.634	19	4055.663	3	1 pc(s).	4055.563

Splitter hole punch set, M16 to M40

for sheet steel, with triple splitting

For punching round cut-outs. The hole punch is operated with a wrench or hydraulic punch.

Design:

- With triple splitting

Supply includes:

- 5 female dies
- 5 male dies
- Plastic case

Note:

- When operating with wrenches, tension screws with ball bearings should be used

Accessories:

- Tension screw, see page 602
- Hydraulic tension screw, see page 603

For threads	Ø punch mm	Tension screw with ball bearing Model No.	Hydraulic tension screw Model No.	Maximum machinable material thickness, sheet steel mm	Packs of	Model No.
M16	16.2	4055.631	4055.661	2	1 pc(s).	4055.580
M20	20.4	4055.631	4055.661	2		
M25	25.4	4055.631	4055.661	2		
M32	32.5	4055.633	4055.663	3		
M40	40.5	4055.634	4055.663	3		

Splitter hole punch set, M12 to M40

for sheet steel, with triple splitting

For punching round cut-outs. The hole punch is operated with a wrench or hydraulic punch.

Design:

- With triple splitting

Supply includes:

- 6 female dies
- 6 male dies
- Tension screw with ball bearing Ø 6 x 40 mm
- Tension screw with ball bearing Ø 9.5 x 50 mm
- Tension screw with ball bearing Ø 19 x 55 mm
- HSS pilot drill Ø 10 mm
- 1 can of lubricant paste
- Plastic case

Note:

- When operating with wrenches, tension screws with ball bearings should be used

Accessories:

- Hydraulic tension screw, see page 603

For threads	Ø punch mm	Hydraulic tension screw Model No.	Maximum machinable material thickness, sheet steel mm	Packs of	Model No.
M12	12.5	4055.660	1.5	1 pc(s).	4055.581
M16	16.2	4055.661	2		
M20	20.4	4055.661	2		
M25	25.4	4055.661	2		
M32	32.5	4055.663	3		
M40	40.5	4055.663	3		



Hole punching tools

Hole punches



Splitter hole punch set, PG 9 to PG 21

for sheet steel, with triple splitting

For punching round cut-outs. The hole punch is operated with a wrench or hydraulic punch.

Design:

- With triple splitting

Supply includes:

- 6 female dies
- 6 male dies
- 2 tension screws with ball bearing \varnothing 9.5 x 50 mm
- HSS pilot drill \varnothing 10 mm
- 1 tube of lubricant paste
- Plastic case

Note:

- When operating with wrenches, tension screws with ball bearings should be used



Accessories:

- Hydraulic tension screw, see page 603

For PG	\varnothing punch mm	Hydraulic tension screw Model No.	Maximum machinable material thickness, sheet steel mm	Packs of	Model No.
9 11 13 16 21	15.2 18.6 20.4 22.5 28.3 30.5	4055.661	2	1 pc(s).	4055.582

Hole punching tools

Hole punches

Splitter hole punch, round

for stainless steel, round, with triple splitting

For punching round cut-outs. The hole punch is operated with a wrench or hydraulic punch.

Design:

- With triple splitting

Supply includes:

- Female dies
- Male dies

Note:

- When operating with wrenches, tension screws with ball bearings should be used



Also required:

- Tension screw, see page 602
- Hydraulic tension screw, see page 603
- Hydraulic tension screw for higher loads, see page 603



For threads	For PG	Ø punch mm	Tension screw (Ø x L) mm	Tension screw with ball bearing Model No.	Hydraulic tension screw Ø mm	Hydraulic tension screw Model No.	Maximum machinable material thickness, stainless steel mm	Packs of	Model No.
–	9	15.2	11.1 x 60	4055.632	11.1/19	4055.665	2	1 pc(s).	4055.115
M16	–	16.2	11.1 x 60	4055.632	11.1/19	4055.665	2	1 pc(s).	4055.116
–	11	18.6	11.1 x 60	4055.632	11.1/19	4055.665	2	1 pc(s).	4055.118
M20	13	20.4	11.1 x 60	4055.632	11.1/19	4055.665	2	1 pc(s).	4055.120
–	16	22.5	11.1 x 60	4055.632	11.1/19	4055.665	2	1 pc(s).	4055.122
M25	–	25.4	11.1 x 60	4055.632	11.1/19	4055.665	2	1 pc(s).	4055.125
–	21	28.3	19 x 55	4055.633	19	4055.663	2.5	1 pc(s).	4055.128
–	–	30.5	19 x 55	4055.633	19	4055.663	2.5	1 pc(s).	4055.130
M32	–	32.5	19 x 55	4055.633	19	4055.663	2.5	1 pc(s).	4055.132
–	–	34.6	19 x 55	4055.633	19	4055.663	2.5	1 pc(s).	4055.134
–	29	37	19 x 55	4055.633	19	4055.663	2.5	1 pc(s).	4055.137
M40	–	40.5	19 x 75	4055.634	19	4055.663	2.5	1 pc(s).	4055.140
–	–	43.2	19 x 75	4055.634	19	4055.663	2.5	1 pc(s).	4055.143
–	36	47	19 x 75	4055.634	19	4055.663	2.5	1 pc(s).	4055.147
–	–	49.6	19 x 75	4055.634	19	4055.663	2.5	1 pc(s).	4055.149
M50	–	50.5	19 x 75	4055.634	19	4055.663	2.5	1 pc(s).	4055.150
–	42	54	19 x 75	4055.634	19	4055.663	2.5	1 pc(s).	4055.154
–	48	60	19 x 75	4055.634	19	4055.663	2.5	1 pc(s).	4055.160
–	–	61.5	19 x 75	4055.634	19	4055.663	2.5	1 pc(s).	4055.161
M63	–	63.5	19 x 75	4055.634	19	4055.663	2.5	1 pc(s).	4055.163

Hole punching tools

Hole punches

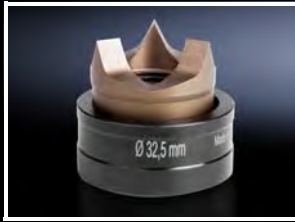

Splitter hole punch set, metric

for stainless steel, round, with triple splitting

For punching round cut-outs. The hole punch is operated with a wrench or hydraulic punch.

Design:

- With triple splitting

Supply includes:

- 5 female dies
- 5 male dies
- Plastic case

Note:

- When operating with wrenches, tension screws with ball bearings should be used



Also required:

- Tension screw, see page 602
- Hydraulic tension screw, see page 603
- Hydraulic tension screw for higher loads, see page 603

For threads	Ø punch mm	Tension screw with ball bearing Model No.	Hydraulic tension screw Model No.	Maximum machinable material thickness, stainless steel mm	Packs of	Model No.
M16	16.2	4055.632	4055.665	2	1 pc(s).	4055.180
M20	20.4	4055.632	4055.665	2		
M25	25.4	4055.632	4055.665	2		
M32	32.5	4055.633	4055.663	2.5		
M40	40.5	4055.634	4055.663	2.5		

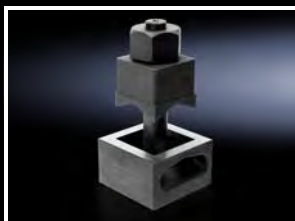

Hole punch, square

for sheet steel

For punching square cut-outs. The hole punch is operated with a hydraulic punch.

Benefits:

- With side ejector for the waste
- No jamming of the die

Supply includes:

- Female dies
- Male dies
- Tension bolts
- Lock nut
- Plastic case

□ punch mm	Maximum machinable material thickness, sheet steel mm	Product-specific scope of supply	Operation, manual	Operation, hydraulic	Packs of	Model No.
22.2 x 22.2	2	Pressure nut with ball bearing Adaptor for hydraulics	■	■	1 pc(s).	4055.322
45.5 x 45.5	3	-	-	■	1 pc(s).	4055.345
46 x 46	3	-	-	■	1 pc(s).	4055.346
50.8 x 50.8	3	-	-	■	1 pc(s).	4055.350
68 x 68	3	-	-	■	1 pc(s).	4055.368
92 x 92	3	Spacer sleeve Special tension bolt	-	■	1 pc(s).	4055.392

Hole punching tools

Hole punches

Hole punch, rectangular

for sheet steel

For punching rectangular cut-outs. The hole punch is operated with a wrench or hydraulic punch.

Benefits:

- With side ejector for the waste
- No jamming of the die

Supply includes:

- Female dies
- Male dies
- Tension bolts
- Lock nut
- Plastic case

□ punch mm	Maximum machinable material thickness, sheet steel mm	Product-specific scope of supply	Operation, manual	Operation, hydraulic	Packs of	Model No.
22 x 30	2	Pressure nut with ball bearing Adaptor for hydraulics	■	■	1 pc(s).	4055.400
22 x 42	2	Pressure nut with ball bearing Adaptor for hydraulics	■	■	1 pc(s).	4055.401
45 x 92	2	-	-	■	1 pc(s).	4055.402
46 x 92	2	-	-	■	1 pc(s).	4055.403



Hole punch, special contour

for sheet steel

For punching cut-outs with a special contour. The hole punch is operated with a wrench or hydraulic punch.

Benefits:

- With side ejector for the waste
- No jamming of the die

Supply includes:

- Female dies
- Male dies
- Tension bolts
- Lock nut
- Pressure nut with ball bearing
- Adaptor for hydraulics
- Plastic case

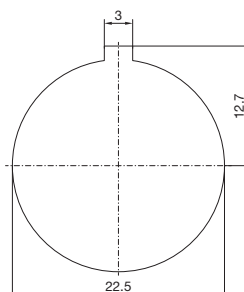

4055.440

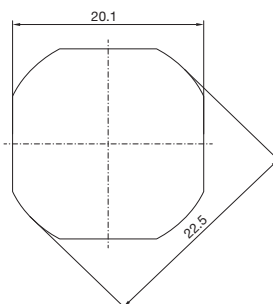

4055.441

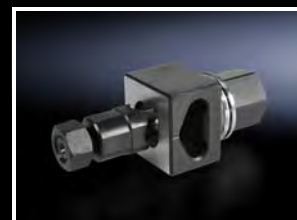

Design	Ø punch mm	Maximum machinable material thickness, sheet steel mm	Packs of	Model No.
With 3 mm lug	22.5	2	1 pc(s).	4055.440
Flattened to 20.1 mm on 4 sides	22.5	2	1 pc(s).	4055.441

Hole punching tools

Hole punches



Hole punch, heavy connectors

for sheet steel

For punching rectangular cut-outs for connectors. The hole punch is operated with a hydraulic punch.

Benefits:

- With side ejector for the waste
- No jamming of the die
- When the die and stamp are compressed, the mounting holes for connectors are marked on the metal sheet between them

Supply includes:

- Female dies
- Male dies
- Tension bolts
- Lock nut

□ punch mm	No. of poles	Maximum machinable material thickness, sheet steel mm	Packs of	Model No.
36 x 52	6-pole	2	1 pc(s).	4055.460
36 x 65	10-pole	2	1 pc(s).	4055.461
36 x 86	16-pole	2	1 pc(s).	4055.463
36 x 112	24-pole	2	1 pc(s).	4055.465



Tension screw

Accessories for hole punches. Required as a connecting part between the die and stamp.

Note:

- For operation with wrench

Tension screw (Ø x L) mm	Packs of	Model No.
9.5 x 40	1 pc(s).	4055.600
9.5 x 50	1 pc(s).	4055.601
19 x 55	1 pc(s).	4055.602
19 x 75	1 pc(s).	4055.603



Tension screw

with ball bearing

Accessories for hole punches. Required as a connecting part between the die and stamp.

Note:

- For operation with wrench

Tension screw (Ø x L) mm	Packs of	Model No.
6 x 40	1 pc(s).	4055.630
9.5 x 50	1 pc(s).	4055.631
11.1 x 60	1 pc(s).	4055.632
19 x 55	1 pc(s).	4055.633
19 x 75	1 pc(s).	4055.634



Hole punching tools

Hole punches

Hydraulic tension screw

Accessories for hole punches. Required as a connecting part between the die and stamp.

Note:

- For operation via hydraulic punch

Hydraulic tension screw Ø mm	Product-specific scope of supply	Packs of	Model No.
6/19	Adaptor for hydraulics	1 pc(s).	4055.660
9.5/19	Adaptor for hydraulics	1 pc(s).	4055.661
11.1/19	Adaptor for hydraulics	1 pc(s).	4055.662
19	-	1 pc(s).	4055.663



Hydraulic tension screw for higher loads

Accessories for hole punches. Required as a connecting part between the die and stamp.

Benefits:

- Hydraulic tension screw made from high-alloy tool steel for higher loads

Note:

- For operation via hydraulic punch

Hydraulic tension screw Ø mm	Packs of	Model No.
9.5/19	1 pc(s).	4055.664
11.1/19	1 pc(s).	4055.665

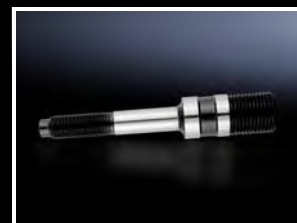

Notching pliers

Punches slots quickly and easily. Saves the time-consuming process of filing the grooves for anti-twist protection of push buttons, switches and instruments. Slots in sizes 3.2 mm and 4.8 mm can be created.

Benefits:

- Long service life
- Male and female die made from hardened tool steel
- Easy punching with large leverage

Material:

- Handles: Plastic-coated

Maximum machinable material thickness, sheet steel mm	Packs of	Model No.
2	1 pc(s).	4055.690



Wiring duct cutter MC 125



For manual cutting of wiring ducts, with adjustable length end stop for the machined material. Anodised contact surface with laser-engraved calibration in millimetres and inches. Integral finger guard ensures safe machining. Intended for mounting on a workbench.

Benefits:

- Enables inexpensive manual cutting of wiring ducts
- Easier for cutting wiring ducts to length compared to sawing by hand

Machinable material:

- Plastic

Model No.	Packs of	4050.435	Page
Footprint size (W x H x D) mm		1332 x 798 x 405	
Max. machinable width of cable duct mm		125	
Max. machinable wall thickness of cable duct mm		2.5	
Max. insertion height mm		28	
Weight kg		15.0	
Accessories			
Spare blade MC 125	1 pc(s).	4050.436	

Support rail cutter MC3

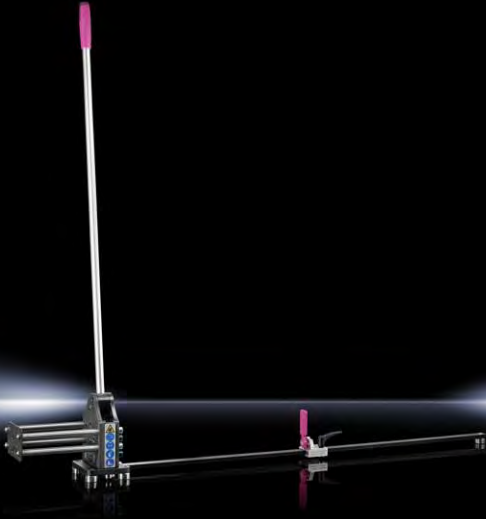

Support rails Page 996 **Mounting angles** Page 996

Manual profile cutter for cutting C rails 30/15 and support rails TS 35/7.5 and TS 35/15 to length, burr-free. The desired rail length is set precisely and reproducibly using the ruler (mm/inch) and the adjustable end stop. For mounting on the workbench.

Benefits:

- Inexpensive manual cutting of mounting angles and support rails

- Easier to cut mounting angles and support rails to the correct length than sawing by hand
- Burr-free cutting to length with eccentric lever, no major force required
- Low-maintenance and with a long service life

Machinable material:

- Sheet steel
- Aluminium
- Copper

Model No.	Packs of	4050.437	Page
Maximum machinable material thickness mm		1.5	
Footprint size (W x H x D) mm		1343 x 1162 x 312	
Weight kg		14.0	
Accessories			
Support rail TS 35/15		see page	997
Support rail TS 35/7.5		see page	997
C rails 30/15		see page	996

Assembly frames and LT 1000 storage and transport trolley



We have the perfect ergonomic solution for you, particularly when it comes to the automation and rationalisation of every stage of the enclosure machining, assembly, wiring and testing process. Our assembly frames are mobile, tiltable and (depending on the version) height-adjustable for machining mounting plates and enclosures. All types offer simple, variable fixing of mounting plates using quick-release fasteners, are independent from the mains power, and take up minimal space when not in use. For easier handling of enclosure panels, we also offer the storage and transport trolley LT 1000.

- Tilt-adjustable and optionally height-adjustable for ergonomic, effective, time-saving construction, wiring and testing of mounting plates or complete enclosures

- Numerous adaptation options available:
 - Widening to a maximum of 1900 mm
 - Wire routing
 - Wire reel holder

More options, see brochure "Rittal Automation Systems – Automate your panel building and switchgear manufacturing", from page 58

- Individually adjustable thanks to height-adjustable supports



- Four castors including total lock function ensure simple handling



- Eight wide fan sections for effortless storage and transportation of enclosure panels
- User-friendly transportation through the workshop on castors

Assembly frame



Accessories Page 608

The assembly frames are mobile, tiltable and (depending on the version) height-adjustable frames for assembling plates and enclosures.

Benefits:

- For ergonomic, back-friendly working
- Individually positionable in the workshop, as it is independent from the power network
- Minimum space requirements during non-use
- Simple handling due to four castors including total lock function
- Variable fixing of mounting plates with a quick-release fastener

Technical specifications:

- Tilt adjustment approx. 0 – 80°

Supply includes:

- Assembly frame
 - 1 clamping unit pack, bottom
 - 1 clamping unit pack, top
- Please observe the product-specific scope of supply.

Note:

- With the assembly frame extension, a maximum machining area of 1900 x 1900 mm can be achieved

Model No.	Packs of	4050.150	4050.200	4050.300	Page
Design		150 MN (manually tilt-adjustable)	200 EN (electrically tilt-adjustable)	300 ENH (electrically tilt- and height-adjustable)	
Dimensions (W x D) mm		1400 x 1250	1400 x 1250	1400 x 1250	
Dimensions of support surface (W x H) min. mm		1110 x 1230	1110 x 1230	1110 x 1230	
Dimensions of support surface (W x H) max. mm		1110 x 1900	1110 x 1900	1110 x 1900	
Load capacity kg		150	200	300	
Working height (min./max.) cm		100 / 100	90 / 90	80 / 110	
Weight kg		138.0	148.0	250.0	
Product-specific scope of supply					
Charger unit		-	■	■	
Battery		-	■	■	
Accessories					
Extension	1 pc(s).	4050.210	4050.210	4050.210	608
Enclosure set	1 pc(s).	4050.211	4050.211	4050.211	608
Wire routing	1 pc(s).	4050.212	4050.212	4050.212	608
Clamping unit		see page	see page	see page	608
Wire reel holder	1 pc(s).	4050.216	4050.216	4050.216	609
Screw adaptor	1 pc(s).	4050.218	4050.218	4050.218	609
Set of brackets	1 pc(s).	4050.221	4050.221	4050.221	610
Roller conveyor	1 pc(s).	-	-	4050.220	609
Spare battery	1 pc(s).	-	4050.217	4050.217	609
Voltage supply	1 pc(s).	-	4050.219	4050.219	610
Connection adaptor	1 pc(s).	-	4050.222	4050.222	610

Accessories

for assembly frame

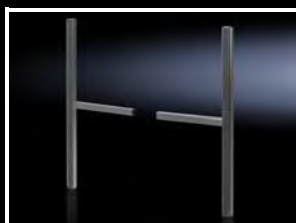

Extension

for assembly frame

For widening assembly frames 150 MN, 200 EN, 300 ENH to a maximum width of 1900 mm.

Supply includes:

- Extension
- Assembly parts

To fit Model No.	Packs of	Model No.
4050.150/4050.200/ 4050.300/4051.100	1 pc(s).	4050.210

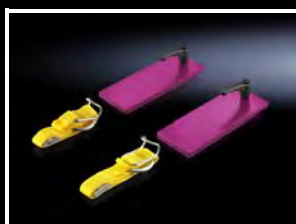

Enclosure set

for assembly frame

For secure attachment of an enclosure such as AX to assembly frame 150 MN, 200 EN, 300 ENH.

Supply includes:

- Packs of 2

To fit Model No.	Packs of	Model No.
4050.150/ 4050.200/ 4050.300	1 pc(s).	4050.211



Wire routing

for assembly frame

For user-friendly handling of wires on assembly frame 150 MN, 200 EN, 300 ENH.

To fit Model No.	Packs of	Model No.
4050.150/ 4050.200/ 4050.300	1 pc(s).	4050.212



Clamping unit

for assembly frame

For secure attachment of a mounting plate onto the assembly frames 150 MN, 200 EN and 300 ENH.



To fit Model No.	For	Design	Product-specific scope of supply	Packs of	Model No.
4050.150/ 4050.200/ 4050.300	Mounting plate VX/SE	Top	1 clamping unit pack, top	2 pc(s).	4050.213
4050.150/ 4050.200/ 4050.300	Mounting plate VX/SE	Bottom	1 clamping unit pack, bottom	2 pc(s).	4050.214

Accessories

for assembly frame

Wire reel holder

for assembly frame

For adapting wire reels or drums on assembly frames 150 MN, 200 EN and 300 ENH.

To fit Model No.	Packs of	Model No.
4050.150/ 4050.200/ 4050.300/ 4051.100	1 pc(s).	4050.216



Spare battery

for assembly frame

Battery to fit electrical tilt/height adjuster for assembly frame 200 EN, 300 ENH.

To fit Model No.	Packs of	Model No.
4050.200/ 4050.300	1 pc(s).	4050.217



Screw adaptor

for spindle hoist

For operating the assembly frame spindle drive using a cordless screwdriver. To fit assembly frame 150 MN.

To fit Model No.	Packs of	Model No.
4050.150	1 pc(s).	4050.218

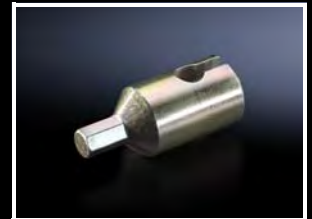

Roller conveyor

for assembly frame

For inserting the mounting plate sideways into the enclosure. To fit assembly frame 300 ENH.

To fit Model No.	Packs of	Model No.
4050.300	1 pc(s).	4050.220

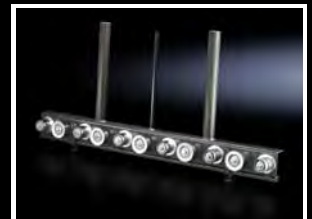

Accessories

for assembly frame

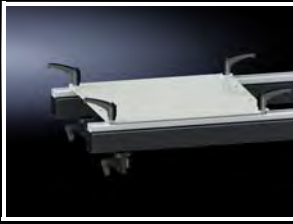

Set of brackets

for assembly frame

For secure attachment of a mounting plate onto the assembly frames 150 MN, 200 EN, 300 ENH.

Supply includes:

- 4 cover caps
- 12 handles
- 2 holders
- 16 washers
- 12 sliding blocks

To fit Model No.	For	Packs of	Model No.
4050.150/ 4050.200/ 4050.300	Mounting plate AX	1 pc(s).	4050.221



Voltage supply

for assembly frame

Charging station power pack for assembly frame 200 EN and 300 ENH.

To fit Model No.	Suitable for rated operating voltage	Packs of	Model No.
4050.200/ 4050.300	110 V	1 pc(s).	4050.219



Also required:

- Connection adaptor, see page 610



Connection adaptor

for voltage supply

Adaptor connector for the power supply to assembly frames 200 EN and 300 ENH.

Design:

- USA, Canada, Central and South America, Japan

To fit Model No.	Packs of	Model No.
4050.200/4050.300	1 pc(s).	4050.222



Also required:

- Voltage supply, see page 610

Storage and transport trolley LT 1000



The LT 1000 warehouse and transport trolley is used for storage and order picking, and ensures easy handling of enclosure panels such as mounting plates, enclosure doors, side panels and rear panels.

Design:

- 2 fan supports each with 8 slots, distance between tubes 100 mm

Benefits:

- Individually adjustable thanks to height-adjustable supports

- Effortless storage and transportation of enclosure panels
- User-friendly transportation on industrial castors
- Fan support, powder-coated, protects enclosure panels such as doors, side panels etc. from scratches and damage

Material:

- Base plate: Plastic
- Fan support: Steel, powder-coated

Model No.	Packs of	4050.000	Page
Transport dimensions (W x H x D) mm		1000 x 1500 x 1000	
Load capacity kg		500	
Weight kg		122.0	

Functional trolley



The functional trolley is a veritable multi-talent: Whether for transporting materials and tools to the installation site or for commissioning, the functional trolley is perfectly suited for assembly technicians and service personnel. The sophisticated fold-out concept is the ideal solution when you are on the road, and its compact dimensions mean that it can be conveniently transported by car.



Folds together for space-saving transportation



Handcart function



Integral folding chair, e.g. for programming work during commissioning

- Made from V2A stainless steel for robustness and durability

- Computer mouse-friendly surface

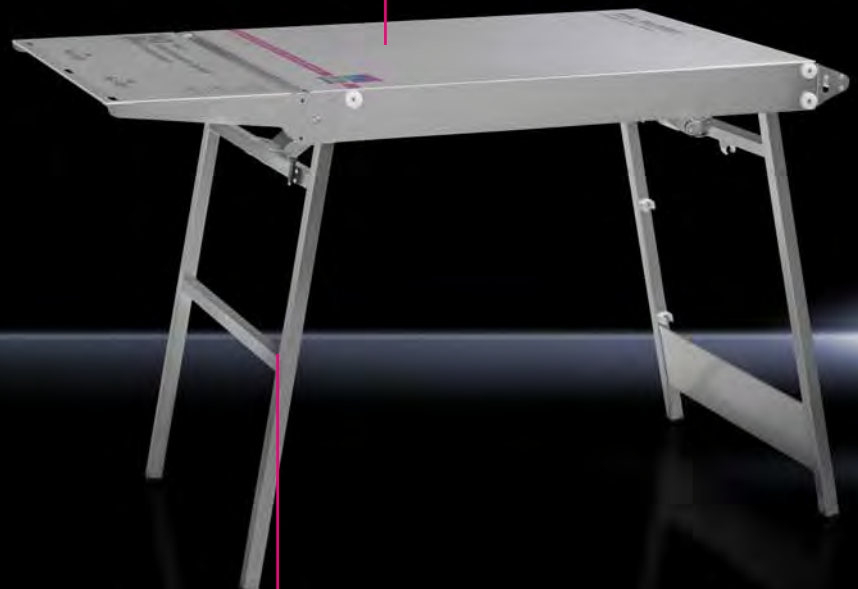

- Converts from a transport function to a practical desk by simply unfolding

Functional trolley

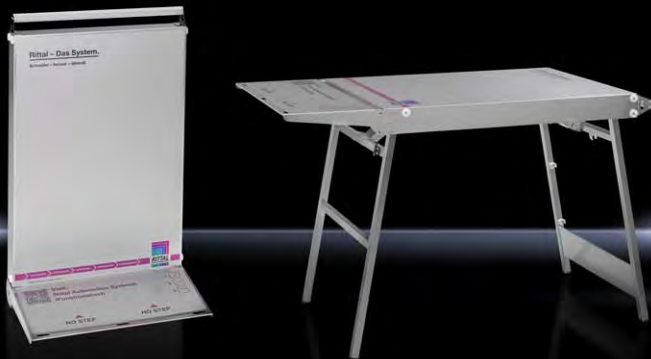

Whether for transporting essential materials and tools to the installation site or for commissioning, the functional trolley's fold-out system is the ideal solution for assembly technicians and service personnel.

Benefits:

- Table surface suitable for computer mouse
- Converts from its transport function to a practical desk by simply unfolding
- High level of resilience and robustness

Material:

- Functional trolley: Stainless steel 1.4301 (AISI 304)
- Work surface: Plastic coating
- Seat surface: Woven polyester fabric, coated in PVC

Load capacity:

- Handcart (max. 20 kg)
- Table (max. 30 kg)
- Folding chair (max. 100 kg)

Supply includes:

- Functional trolley
- Folding chair

Model No.	Packs of	4050.130	Page
Transport dimensions (W x H x D) mm		610 x 1000 x 85	
Handcart dimensions (W x H x D) mm		300 x 610 x 1000	
Table dimensions (W x H x D) mm		1290 x 780 x 610	
Weight kg		20.0	

Smart Lifter enclosure lifting and transportation device

Enclosure logistics made easy: the Smart Lifter allows populated and bayed enclosures up to a maximum weight of 1.8 t and a length of 4.8 m to be safely and easily transported. The height adjuster with torque drive can lift to a height of 230 mm, allowing operators to fit the base/plinth and lower onto pallets or square timbers. By using the torque cranks, the entire system can be gently lowered into place.

- The steering system with heavy-duty castors allows smooth relocation of the enclosure suite, and even rotation on the spot

- Lift function with torque crank handle allows the bayed enclosures to be gently raised and lowered

- Simple, safe relocation of the support points with a lock system makes the Smart Lifter a universal lifting tool for different enclosure depths

- Height adjustment with a lift of 230 mm allows easier fitting of the base/plinth to enclosures

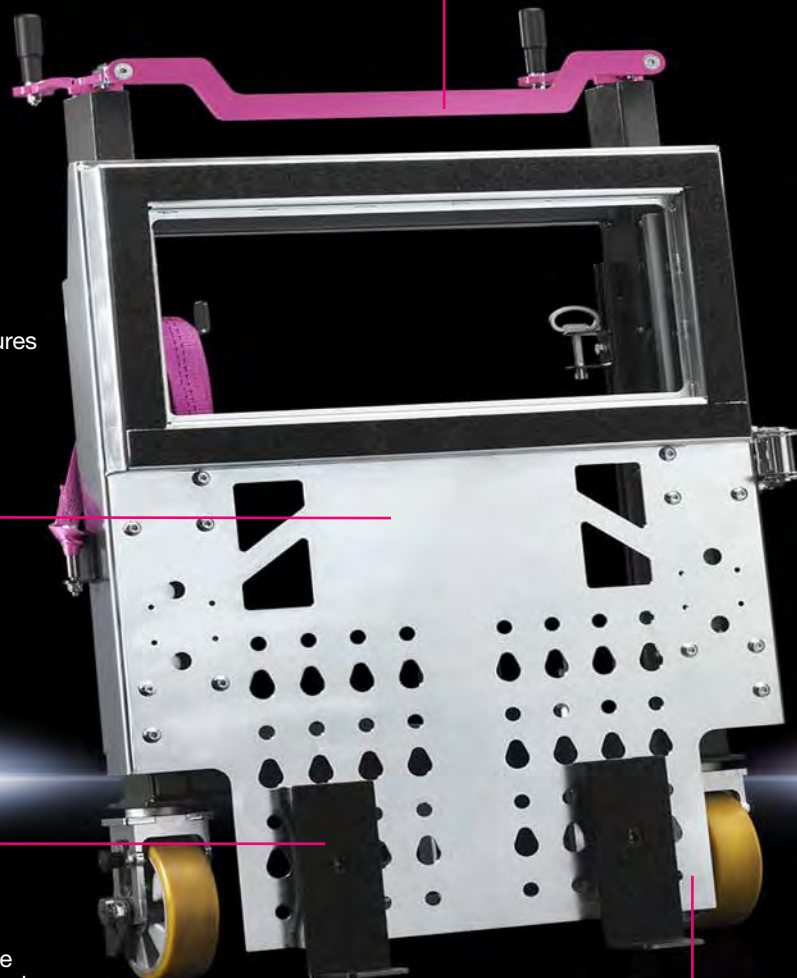



The Smart Lifter is your flexible, mobile transport system for switchgear manufacturers, logistics specialists and service teams.

The Smart Lifter is distinguished by its versatility and industrial design with built-in torque crank handle to protect employees from incorrect operation.



The belt and double-bit key are stored outside of the work zone



The torque crank handle allows bayed enclosures to be raised and lowered with minimal force



Steering system for easy manoeuvring



Simple base/plinth mounting with lift function up to 230 mm



The pick-up forks for different enclosure depths are easily adjusted



Transportation of enclosures in various lengths, depths and weights

Smart Lifter

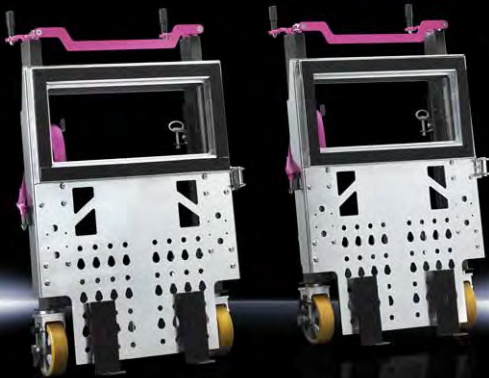

Lifting and transport device for enclosures and enclosure suites up to 4.80 m length.

Benefits:

- Supports simple mounting of base/plinths beneath enclosures
- Easy transportation of bayed enclosures in the workshop or at the installation site
- Flexible use for enclosures of different depths, thanks to adjustable forks
- Ergonomic working (lifting and lowering) with a torque crank

Functions:

- Transportation of bayed enclosures up to a length of 4.80 m
- Lifting of bayed enclosures up to a height of 230 mm and a weight of 1800 kg

Technical specifications:

- Dimensions per trolley (W x H x D): 750 x 1100 x 400 mm

Supply includes:

- 2 transport trolleys

Model No.		4050.005	Page
Load capacity kg		1800	
Weight kg		70.0	

Boost efficiency, cut costs

The digital twin engineered using Eplan software tools links together all downstream processes in panel building and switchgear manufacturing 4.0.



Cutting

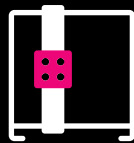

Panel Modification

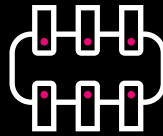

Terminal Strip Assembly



Wire Fabrication

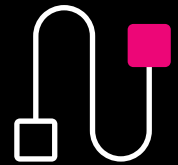

Wiring



Smart Wiring [↗](#)

The browser-based EPLAN Smart Wiring solution supplies all wiring data in a 100% digital form and visualises your wiring in 3D. Users benefit from a significant reduction in errors and substantial time savings. A digital twin of the enclosure also contains all the information needed for wiring enclosures. See page 32.

Wire Station WS 540 wiring workstation

For flexible, efficient wire assembly and wiring work in the workshop. The wiring workstation is the ideal interface between the fully automated production of wires with the Rittal Wire Terminal and wiring work on mounting plates or in the enclosure. The Wire Station WS 540 is an ergonomic process optimiser for use with all wiring-related activities.

- Universal accessories tailored to the application, such as component supports for semi-automatic machines
- Optional workstation add-ons help to boost flexibility and efficiency in essential manual process stages

EPLAN Smart Wiring: Wiring made easy

- Using data from the Digital Twin
- Wire lists with filter function
- Visualisation of cable routes
- Wiring plan revision management

- Stocking and processing of pre-produced wires from the Rittal Wire Terminal
- Complete project handling with variable arrangement of the wire magazines directly at the workstation



Wire management, stocking and production

- Automatic cutting with the Rittal C8+ length-cutting machine accelerates and streamlines the manual wiring process



Wire Terminal WT fully automated wire processing machine
Fully automated wire processing with patented ordering system, see page 656



Rittal assembly frames
Flexible, straightforward handling in the workshop. Ergonomically adjustable assembly frames for building and wiring enclosures and mounting plates, see page 606

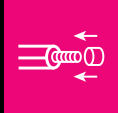

With the complete modular system surrounding the WS 540, your workstation can be functionally adapted to suit individual panel building and switchgear manufacturing requirements. Assistance is at hand for process-optimised project handling with EPLAN Smart Wiring, the Rittal length-cutting, insulation-stripping and crimping machines, and label printers. Another modular element to boost efficiency in modern panel building and switchgear manufacturing.



Optional monitor support



Integral scale and electrically adjustable operating height



Optional tool/drinks holder



Optional Mini-PC holder



Optional wire routing for up to 8 different wires



Integral socket strip



Integral shadow board to fit Rittal tools such as screwdrivers, side cutters, crimping tools etc., see page 566

To fit the following products:

- 4052.058, 4052.141
- 4052.101, 4052.142
- 4052.102, 4054.002
- 4052.104, 4054.004
- 4052.106, 4054.141
- 4052.107, 4054.300
- 4052.121, 4054.410
- 4052.122, 4054.600
- 4052.131, 4054.750
- 4052.132, 4054.850

Wire Station WS 540



Accessories for Wire Station WS 540 Page 621 **Length-cutting machine C8+** Page 632 **Crimping machines** From page 634

Mobile wiring workstation, height-adjustable, for flexible use in the workshop. For ergonomic, fatigue-free wire processing work.

Benefits:

- Electronically adjustable desk for the optimum working height, adjustable from 710 – 1250 mm
- Multiplex worktop, washable and scratch-resistant
- Ideal solution in conjunction with the length-cutting and crimping machines plus pre-assembled wires with the Wire Terminal

- Integral scale for quick manual measurements
- Prepared to accommodate a monitor for wire processing with EPLAN Smart Wiring
- Optionally expandable with shelves for wire boxes, wire reels and holders for tools and small parts
- For flexible use in the workshop thanks to rubberised wheels
- Drawer with shadow board prepared for tools

Supply includes:

- Wiring table with electrical height adjuster
- Connection cable, 7 m
- 7-way socket strip, with rocker switch

Note:

- The vertical mounting braces, Model No. 4051.106, are required for accessories such as storage box holders, magazine supports etc.

Model No.	Packs of	4051.100	Page
Dimensions (W x H x D) mm		900 x 1350 x 781	
Working height (min./max.) mm		710 / 1205	
Input voltage		230 V AC, 50 Hz	
Weight kg		95.0	
Accessories			
Shelf	2 pc(s).	4051.101	621
Component support, left	1 pc(s).	4051.102	621
Component support, right	1 pc(s).	4051.103	622
Monitor attachment	1 pc(s).	4051.104	622
LED work light	1 pc(s).	4051.105	623
Mounting braces, vertical	1 pc(s).	4051.106	623
Storage box holder	1 pc(s).	4051.107	624
Adaptor bracket	1 pc(s).	4051.108	624
Waste bin	1 pc(s).	4051.115	624
Socket strip	1 pc(s).	4051.114	625
Magazine support	1 pc(s).	4051.111	625
Wire routing for mounting braces, vertical	1 pc(s).	4051.120	625
Wire routing for component support, left	1 pc(s).	4051.121	626
Wire pack holder		see page	626
Wire coil holder		see page	627
Wire reel holder	1 pc(s).	4050.216	609
Tool holder, round	1 pc(s).	4051.113	627
Stripping machine console	1 pc(s).	4051.112	628
Universal utility shelf	1 pc(s).	4051.109	628
Mini-PC holder	1 pc(s).	4051.110	628

Accessories

for Wire Station WS 540

Shelf

for WS 540

Shelf set for mounting below the desktop. Different shelf depths provide ample knee and leg room for seated working at the workstation.

Benefits:

- For optimum use of the space beneath the desktop without restricting legroom
- Tool-free mounting of the shelves by simply hanging in place

Technical specifications:

- Top shelf (W x D): 510 x 335 mm
- Bottom shelf (W x D): 510 x 200 mm

Material:

- Sheet steel

Colour:

- RAL 7016

Supply includes:

- 2 shelves

Packs of	Model No.
2 pc(s).	4051.101

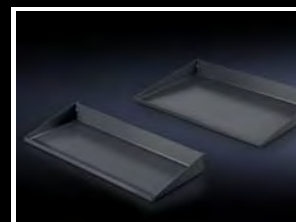

Component support, left

for WS 540

Component support unit to fit length-cutting machine C8+ and an additional shelf to accommodate most common label printer brands. Mounted on the left of the WS 540 Wire Station.

Benefits:

- Additional shelf for universal use
- Compact external mounting
- Flexibly adjustable in the width and height

Technical specifications:

- Component support (W x H x D): 360 x 335 x 20 mm, including height adjustment of 480 mm
- Support arm (W x H): 500 x 700 mm
- Shelf (W x H x D): 417 x 267 x 20 mm

Material:

- Sheet steel

Colour:

- RAL 7016

Supply includes:

- Component support for the C8+ length-cutting machine
- Semi-automated machine support arm, left
- Universal shelf for printer/label printer
- Assembly parts

Packs of	Model No.
1 pc(s).	4051.102



Accessories

for Wire Station WS 540



Component support, right for WS 540

Component support unit to fit crimping machine RC or R8 E, for mounting on the right of the Wire Station WS 540.

Benefits:

- Compact external mounting
- Flexibly adjustable in the width and height

Technical specifications:

- Component support (W x H x D): 318 x 313 x 20 mm, including conduit for height adjustment of 480 mm
- Support arm (W x H): 500 x 700 mm

Material:

- Sheet steel

Colour:

- RAL 7016

Supply includes:

- Component support for crimping machines
- Semi-automated machine support arm, right
- Assembly parts

Packs of	Model No.
1 pc(s).	4051.103



Monitor attachment for WS 540

For mounting all commercially available monitors up to screen diagonals of 32" with Vesa 75/100.

Benefits:

- Stable monitor attachment
- Vertically hinged
- Height-adjustable

Technical specifications:

- Height-adjustable up to 285 mm
- Extendable up to 430 mm
- Swivel range left/right with full extension 90°
- Swivel range of ball head 35° all-round
- Vesa 75/100

Material:

- Aluminium/sheet steel

Supply includes:

- Monitor attachment
- Assembly parts

Approvals:

- GS-tested

Load capacity max. kg	Packs of	Model No.
10	1 pc(s).	4051.104

Accessories

for Wire Station WS 540

LED work light

for WS 540

For attaching to the table top, with clamping device.

Benefits:

- Bright, glare- and flicker-free lighting, homogeneous and shadow-free
- Selectable colour temperature between warm white, neutral white and daylight white promotes concentration and reduces symptoms of fatigue
- Excellent colour fidelity and high contrast
- Aluminium spring arm with 3D head joint, swivelling and lockable for free positioning of the light source

Technical specifications:

- Spring arm: Length 970 mm
- Colour reproduction: 94 – 98 Ra
- Transmission angle: 100°

Material:

- Light housing: Aluminium
- Glare control: Macrolon

Protection category IP to IEC 60 529:

- IP 40

Protection class:

- III (SELV)

Supply includes:

- LED work light
- Assembly parts

Width mm	545
Height mm	90
Depth mm	35
Luminous flux lm	2930
Light	84 SMD LEDs
Rated operating voltage V, ~, Hz	110 - 240, 1~, 50/60
Power consumption W	26
Service life h	≥ 60000
Operating temperature	-10 °C...+40 °C
Length of connection cable m	3
Connection options	Plug-in power supply (CEE 7/16) with AC adaptor
Packs of	1 pc(s).
Model No.	4051.105

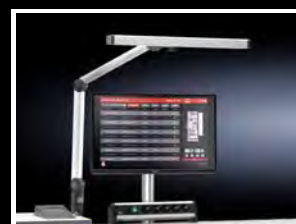

Mounting braces, vertical

for WS 540

For optional attachment of accessories such as wire pack holders, open-fronted storage boxes and shelves.

Benefits:

- Individual and functional configuration with component supports, storage box holders, consoles, wire pack holders, etc.
- Simple screw-fastening of accessories
- Individual height adjustment of the accessories with a rail system

Technical specifications:

- Dimensions (W x H x D): 85 x 1350 x 50 mm

Material:

- Sheet steel

Colour:

- RAL 7016

Packs of	Model No.
1 pc(s).	4051.106



Accessories

for Wire Station WS 540



Storage box holder

for WS 540

For fastening to the vertical mounting braces of the WS 540 and for storing small parts and accessories.

Technical specifications:

- Dimensions of storage box holder (W x H x D): 110 x 350 x 15 mm
- Dimensions of open-fronted storage box (W x H x D): 100 x 85 x 160 mm

Material:

- Support: Sheet steel
- Open-fronted storage boxes: Plastic

Colour:

- Support: RAL 7016
- Open-fronted storage boxes: Yellow

Supply includes:

- Storage box holder
- 3 open-fronted storage boxes
- Assembly parts

Packs of	Model No.
1 pc(s).	4051.107



Also required:

- Mounting braces, vertical, see page 623



Adaptor bracket

for WS 540

For individual configuration and enlargement of the WS 540. The adaptor bracket is required for mounting additional vertical mounting braces and supports a range of width settings from 50 – 400 mm.

Technical specifications:

- Side dimensions (W x H): 483 x 383 mm

Material:

- Sheet steel

Colour:

- RAL 7016

Packs of	Model No.
1 pc(s).	4051.108



Also required:

- Mounting braces, vertical, see page 623



Waste bin

for WS 540

For waste disposal directly at the workstation.

Benefits:

- Front mounting without impairing legroom

Technical specifications:

- Dimensions (W x H x D): 150 x 290 x 320 mm
- Capacity: 12 litres

Material:

- Plastic

Colour:

- Dark grey

Supply includes:

- Waste bin
- Bracket
- Assembly parts



Packs of	Model No.
1 pc(s).	4051.115

Accessories

for Wire Station WS 540

Socket strip

for WS 540

For mounting on the worktop of the WS 540.

Design:

- 5-way, with rocker switch (green)

Benefits:

- Ergonomic access thanks to the 45° angle on the worktop

Material:

- Extrusion: Aluminium
- Socket inserts: Plastic

Supply includes:

- Socket strip, connection cable and earthing contact plug
- Assembly parts

Electrical connection V, Hz	Rated current A	Packs of	Model No.
230, 50	16	1 pc(s).	4051.114



Magazine support

for WS 540

To accommodate up to 4 wire rail magazines with pre-assembled wires from the Wire Terminal WT.

Benefits:

- For universal use on any mounting brace, vertical

Technical specifications:

- Dimensions (W x H x D): 330 x 200 x 35 mm

Material:

- Sheet steel

Colour:

- RAL 7016

Supply includes:

- Magazine support
- Assembly parts

Packs of	Model No.
1 pc(s).	4051.111



Also required:

- Mounting braces, vertical, see page 623



Wire routing for mounting braces, vertical

for WS 540

Targeted wire routing for up to 8 different wires is supported. Mounting on the vertical mounting braces.

Benefits:

- Individually height-adjustable on the mounting brace
- Optimum running characteristics of the wires

Technical specifications:

- Dimensions (W x H x D): 130 x 263 x 322 mm
- Depth adjustment directly at the wire guide up to 100 mm
- Wire routing from 0.5 – 2.5 mm² supported

Material:

- Holder: Sheet steel
- Reel and wire guide: Plastic

Packs of	Model No.
1 pc(s).	4051.120



Also required:

- Mounting braces, vertical, see page 623



Accessories

for Wire Station WS 540



Wire routing for component support, left

for WS 540

Targeted wire routing for up to 8 different wires is supported. For mounting on the component support, left.

Benefits:

- Optimum wire routing to the C8+ length-cutting centre
- Optimum running characteristics of the wires

Technical specifications:

- Dimensions (W x H x D): 129 x 190 x 169 mm
- Wire routing from 0.5 – 2.5 mm² supported

Material:

- Holder: Sheet steel
- Reel and wire guide: Plastic

Packs of	Model No.
1 pc(s).	4051.121



Also required:

- Component support, left, see page 621



Wire pack holder

Shelf for wire packs, to fit assembly frames and WS 540. Attached to the Wire Station on the vertical mounting braces on the left or right.

Technical specifications:

- Dimensions of wire pack holder (W x H x D): 207 x 105 x 207 mm
- Storage space to fit wire packs up to a maximum size of 207 x 207 mm

Material:

- Sheet steel

Colour:

- RAL 7016

Supply includes:

- Wire pack holder
- Assembly parts

To fit Model No.	Design	Packs of	Model No.
4051.100/ 4050.150/ 4050.200/ 4050.300	left	1 pc(s).	4051.116
4051.100/ 4050.150/ 4050.200/ 4050.300	right	1 pc(s).	4051.117



Also required:

- Mounting braces, vertical, see page 623



Accessories

for Wire Station WS 540

Wire coil holder

Wire coil shelf to fit assembly frames and WS 540. Attached to the Wire Station on the vertical mounting braces on the left or right.

Technical specifications:

- Storage space (W x H x D): 375 x 20 x 475 mm

Material:

- Sheet steel

Colour:

- RAL 7016

Supply includes:

- Wire coil holder
- Assembly parts

To fit Model No.	Design	Packs of	Model No.
4051.100/ 4050.150/ 4050.200/ 4050.300	left	1 pc(s).	4051.118
4051.100/ 4050.150/ 4050.200/ 4050.300	right	1 pc(s).	4051.119



Also required:

- Mounting braces, vertical, see page 623

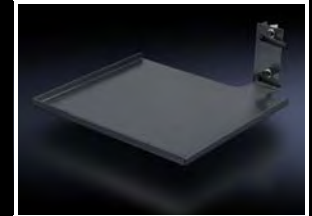

Tool holder, round

for WS 540

For safe storage of hand-held devices or drinks. The tool holder is secured to the desktop.

Applications:

- Holder for hand tools such as cordless screwdrivers, hot-air dryers or beverage bottles
- For hand-held tools up to 80 mm in diameter

Technical specifications:

- Dimensions (W x H x D): 140 x 87 x 200 mm

Material:

- Sheet steel

Colour:

- RAL 7016

Supply includes:

- Tool holder, round
- Assembly parts

Packs of	Model No.
1 pc(s).	4051.113



Accessories

for Wire Station WS 540



Stripping machine console for WS 540

For positioning the S22 stripping machine on the WS 540. The console may be positioned on either the left or right.

Technical specifications:

- Console area (W x D): 278 x 178 mm
- Height-adjustable up to 480 mm

Material:

- Sheet steel

Colour:

- RAL 7016

Packs of	Model No.
1 pc(s).	4051.112

 **Assembly instruction:**

- The stripping machine console is also suitable for component supports 4051.102 and 4051.103



Universal utility shelf for WS 540

Universal utility shelf for mounting on the vertical mounting braces of the WS 540. Storage for tools or small parts.

Technical specifications:

- Dimensions (W x H x D): 130 x 15 x 190 mm

Material:

- Sheet steel

Colour:

- RAL 7016

Supply includes:

- Universal utility shelf
- Assembly parts

Packs of	Model No.
1 pc(s).	4051.109

 **Also required:**

- Mounting braces, vertical, see page 623



Mini-PC holder for WS 540

For secure attachment of a mini-PC to the WS 540. The holder is mounted underneath the workbench on the left.

Technical specifications:

- Dimensions (W x H x D): 70 x 235 x 200 mm
- Individually adjustable up to 60 mm

Material:

- Sheet steel

Colour:

- RAL 7016

Supply includes:

- Mini-PC holder
- Assembly parts

Packs of	Model No.
1 pc(s).	4051.110



Length-cutting machine C8+ and stripping machine S22

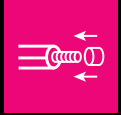

The length-cutting machine C8+ makes work processes more efficient by cutting wires up to 8 mm diameter or 10 mm² cross-section to individually set lengths. Cutting orders can also be managed, documented and transmitted to the length-cutting machine C8+ from a PC or CAE data interface (EPLAN Pro Panel) via USB. In this way, the C8+ length-cutting machine additionally supports the cable labelling and wiring process by displaying the source/target code.

The stripping machine S22 is electrically powered for accurate, careful stripping of the insulation from your wires.

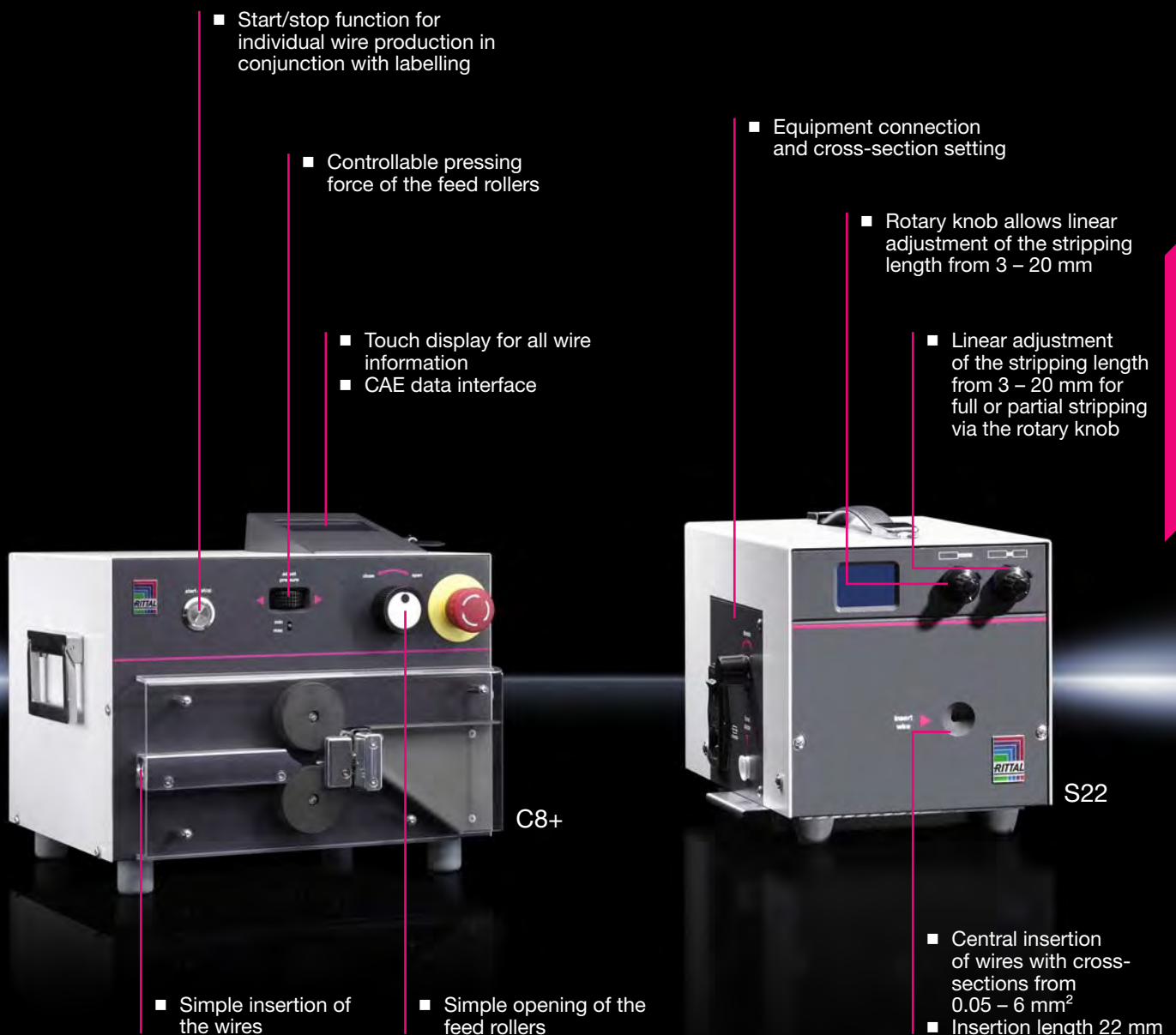

Stripping and crimping machine R8 E



The electrically driven R8 E crimping machine processes insulated wire end ferrules and standard PVC cables in cross-sections ranging from 0.5 to 2.5 mm² (AWG 20 – 14) with a crimping length of 8 mm. For flexible use in the workshop, all you need is a power connection. The machine guarantees UL-certified crimping in conjunction with wire end ferrules from Rittal.



- Holder for taped wire end ferrules on a reel

R8 E

- Easy replacement of consumables
- Simple adjustment
- Flexible use in the workshop

Stripping and crimping machines L8 and RC



Electro-pneumatically driven wire-stripping and crimping machines for safe, fast processing of insulated wire end ferrules. The particular feature of our electro-pneumatic crimping machines is their fully automated detection of the wire cross-section and processing of the wire end ferrules. No tool changes are required. Linear adjustment of the blades and the high forces generated by the pneumatic crimping unit support the processing of all standard cables as well as special ferrules (AWG) in the application range from 0.5 to 2.5 mm² (AWG 20 – 14) with a crimping length of 8 mm. The integrated daily unit counter provides a continuous overview of your project quantities.

The crimping machine RC is suitable for processing wire end ferrules in 8 mm and 10 mm lengths with labelling on the underside. The 5-way holder eliminates the need to switch between wire end ferrules for different cross-sections.

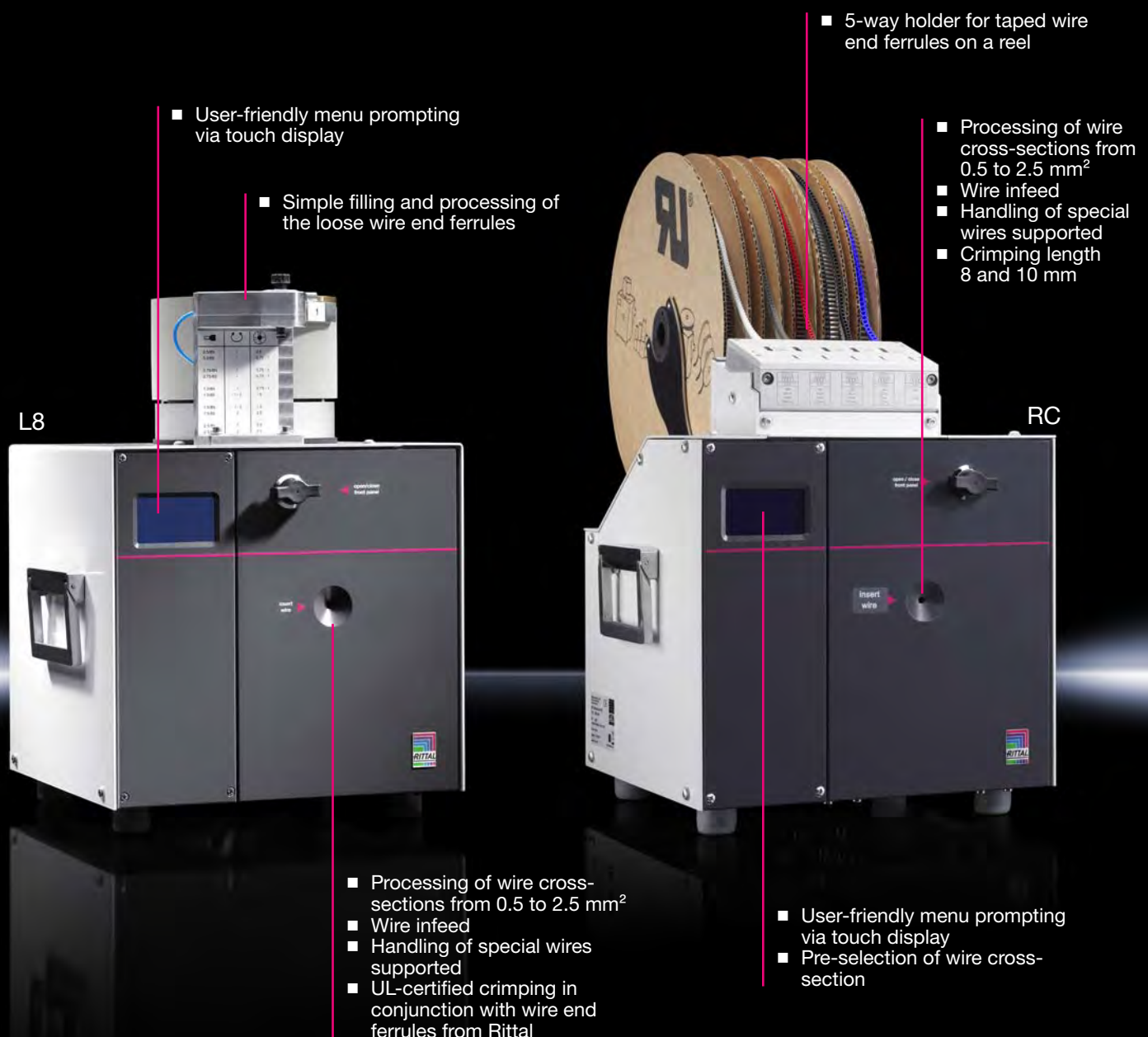

Note:

The wire end ferrules shown here are not included with the supply.

Length-cutting machine C8+



Semi-automated machine for cutting wires to an individually adjustable length.

Design:

- With command panel
- Stop & go function

Benefits:

- User-friendly operation
- Simple insertion of the wires
- Simple opening of the feed rollers
- PC compatible
- Length-cutting with interface to CAE data supported
- Supports the process of labelling cables by showing the connection point on the display
- Simply transmit projects and orders to length-cutting machine C8+

Technical specifications:

- Fine-wire strand 0.08 - 10 mm² (AWG 28 - 8)
- Single-wire strand 0.08 - 2.5 mm² (AWG 28 - 14)
- For wire lengths 1 - 99999 mm
- Feed rate 0 - 1.5 m/s
- Controllable pressing force of the feed rollers
- DC servo-drive
- Insertion length 27 mm (1.06 in.)

Supply includes:

- Length-cutting machine C8+
- Connection cable with connector
- Software connection, CAE data
- Installation CD

Model No.	Packs of	4050.455	Page
Machine dimensions (W x H x D) mm		380 x 470 x 360	
Cycle time s		< 2	
Electrical connection V, ~, Hz		100 - 240, 1~, 50	
Apparent power VA		240	
Interfaces		EPLAN Pro Panel CAE data	
Weight kg		20.0	
Accessories			
Wire dispenser	1 pc(s).	4050.463	637

Stripping machine S22



Semi-automated machine for stripping wires of varying cross-section ranges.

Design:

- Touchscreen display
- Integral counter (total quantity)
- Integral counter (daily quantity)
- Linear adjustment of the wire stripping length

Benefits:

- Cross-section is easily set using the rotary knob
- Simple insertion of the wires
- User-friendly operation

Technical specifications:

- Electrically powered
- Wire stripping range 0.05 - 6 mm² (AWG 30 - 10)
- Insulation stripping length 3 - 20 mm (0.12 - 0.79 in.)
- Draw-off length 3 - 20 mm (0.12 - 0.79 in.)
- Insertion length 22 mm (0.87 in.)

Supply includes:

- Stripping machine S22
- Special funnel for inserting thin conductors
- Spare blades

Model No.	Packs of	4050.451	Page
Machine dimensions (W x H x D) mm		190 x 190 x 295	
Cycle time s		0.5	
Electrical connection V, ~, Hz		100 - 240, 1~, 50/60	
Apparent power VA		70	
Weight kg		7.5	

Crimping machine R8 E



Wire end ferrules Page 578

Electrically powered wire stripping and crimping machine for taped wire end ferrules on a reel.

Design:

- Touchscreen display

Benefits:

- Easy to operate
- Fast adjustment
- Flexible use in the workshop
- Rapid replacement of consumables

Technical specifications:

- Crimping range 0.5 - 2.5 mm² (AWG 20 - 14)
- Crimping length 8 mm (0.31 in.)
- Insertion length 40 mm (1.57 in.)

Note:

- The standard crimping form is trapezoid – others available on request

Model No.	Packs of	4050.454	Page
Machine dimensions (W x H x D) mm		288 x 230 x 345	
Cycle time s		1.8	
Compression		Trapezoid crimp	
Electrical connection V, ~, Hz		100 - 240, 1~, 50/60	
Apparent power VA		100	
Weight kg		16.0	
Accessories			
Wire end ferrules		see page	578

Crimping machine L8



Wire end ferrules Page 578

Electro-pneumatically driven wire stripping and crimping centre for loose, insulated wire end ferrules.

Design:

- Touchscreen display

Benefits:

- Easy to operate
- Secure, fast processing of insulated wire end ferrules
- No set-up time, thanks to automatic tool change
- Handling of special wires supported
- Simple, quick component mounting
- Automatic detection of cross-sections

Technical specifications:

- Crimping range 0.5 - 2.5 mm² (AWG 20 - 14)
- Crimping length 8 mm (0.31 in.)
- Insertion length 35 mm (1.38 in.)
- Processing of wire end ferrules with plastic collars in special sizes supported

Supply includes:

- Crimping machine L8
- 1 oscillating conveyor 0.5 - 1.5 mm²
- 1 oscillating conveyor 1.5 - 2.5 mm²

Note:

- The standard crimping form is trapezoid – others available on request

Model No.	Packs of	4050.452	Page
Machine dimensions (W x H x D) mm		390 x 460 x 330	
Cycle time s		1.5	
Compression		Trapezoid crimp	
Electrical connection V, ~, Hz		100 - 240, 1~, 50/60	
Apparent power VA		110	
Compressed air connection bar		5.5	
Weight kg		31.0	
Accessories			
Oscillating conveyor		see page	637
Wire end ferrules		see page	581

Crimping machine RC



Wire end ferrules Page 578

Electropneumatic crimping machine with 5-way magazine for processing insulated wire end ferrules on a reel.

Design:

- Touchscreen display
- Select the wire cross-section via touchscreen
- Support may be fitted with a maximum of 23,000 wire end ferrules

Benefits:

- Easy to operate
- Secure, fast processing of insulated wire end ferrules
- No set-up time, thanks to automatic tool change
- Simple, quick component mounting
- No changing of the wire end ferrules required due to 5-way magazine

Technical specifications:

- Crimping range 0.5 - 2.5 mm² (AWG 20 - 14)
- Crimping length 8 and 10 mm
- Insertion length 27 mm (1.06 in.)

Note:

- The standard crimping form is trapezoid – others available on request

Model No.	Packs of	4050.456	Page
Machine dimensions (W x H x D) mm		335 x 565 x 485	
Cycle time s		< 2	
Compression		Trapezoid crimp	
Electrical connection V, ~, Hz		100 - 240, 1~, 50/60	
Apparent power VA		16	
Compressed air connection bar		5.5	
Weight kg		22.0	
Accessories			
Wire end ferrules		see page	578

Accessories

for wire processing machines

Oscillating conveyor

for crimping machine L8

Feed guide for loose wire end ferrules.

Benefits:

- Accurate, careful feeding of wire end ferrules

To fit Model No.	Application	Packs of	Model No.
4050.452	For loose wire end ferrules with cross-section 0.5 – 1.5 mm ²	1 pc(s).	4050.467
4050.452	For loose wire end ferrules with cross-section 1.5 – 2.5 mm ²	1 pc(s).	4050.468



Wire dispenser

for length-cutting machine

Dispensing device for the infeed of conductors. Suitable for conductors on cable coils or from boxes.

Benefits:

- Convenient removal and dispensing of cables and wires

Technical specifications:

- Cable coil diameter \leq 300 mm (\leq 11.8 in.)
- Cable coil width \leq 200 mm (\leq 7.9 in.)
- Clamping cone 15 - 23 mm (0.59 - 0.91 in.)
- Box dimensions 240 x 250 x 150 mm (9.45 x 9.84 x 5.9 in.)

Packs of	Model No.
1 pc(s).	4050.463

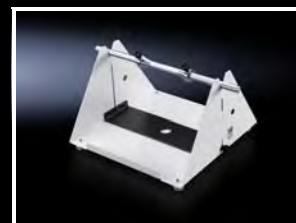

Busbar machining, static CW 120-S



The units in the CW 120-S product series are ideal for bending, punching and cutting busbars. The integral precision laser facilitates the cutting and bending process.

Electro-hydraulic pump

- To operate products in the CW 120-S product series.

Busbar cutting unit

- Time savings compared to manual cutting
- Precise marking of the cutting point

Busbar bending and hole-punching unit

- Simple tool changes
- High level of bending and punching accuracy
- Independent busbar machining



Machining examples for the CW 120-S



Punching



Cutting a busbar to length



Bending a busbar

Busbar machining, mobile CW 120-M



The Copper Workstation CW 120-M is ideal for bending, punching and cutting busbars. It supports cutting and bending up to a maximum width of 120 mm and a maximum thickness of 12 mm. The integral precision laser facilitates the cutting and bending process. Generally speaking, round holes with a diameter of 6.6 to 21.5 mm and slots up to a maximum width of 18 mm and a length of 21 mm may be punched.



Automation Systems

Machining examples for the CW 120-M



Cutting busbars to length with integral precision laser

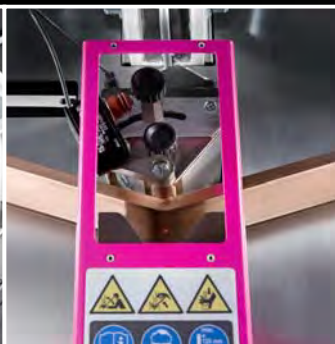

Bending busbars



Punching busbars, pull-out measurement system



Making cut-outs in steel and stainless steel (accessories, hydraulic hose and cylinder, see page 645)

Busbar bending and hole-punching unit CW 120-S



Female dies Page 643 **Male dies** Page 643 **Accessories** Page 644

The bending and hole-punching unit in the CW 120-S product series is ideal for bending and punching busbars. Round holes and slots may be punched. The bending and hole-punching unit is easily positioned on a workbench.

Design:

- Electric protractor
- Length stop
- Mandrel R10
- Bending die
- Laser pointer (auxiliary laser), beam power laser class 1

Benefits:

- High level of bending and punching accuracy
- Simple tool changes

Machinable material:

- Copper
- Aluminium

Note:

- With a Z bend, the length of the short side depends on the material thickness

Model No.	Packs of	4055.700	Page
Machine dimensions (W x H x D) mm		700 x 410 x 461	
Footprint size (W x H x D) mm		756 x 426 x 461	
Bending (max.) mm		120 x 12	
Bending angle (max.) °		90	
Bending/side length (min.) mm		50	
U-bending (min.) mm		100	
Z-bending (min.) mm		72	
Punching (max.) mm		6.6 x 21.5	
Punching/material thickness (max.) mm		12	
Punching/material width (max.) mm		120	
Weight kg		60.0	
Also required			
Electro-hydraulic pump	1 pc(s).	4055.720	644
Foot-switch	1 pc(s).	4055.712	644

Busbar cutting unit CW 120-S



Accessories Page 644

The cutting unit in the CW 120-S product series is ideal for cutting busbars to length. The unit is easily mounted on a workbench.

Design:

- Laser pointer (auxiliary laser), beam power laser class 1

Benefits:

- Significant time savings compared to manual cutting

Machinable material:

- Copper
- Aluminium

Model No.	Packs of	4055.710	Page
Machine dimensions (W x H x D) mm		335 x 370 x 275	
Footprint size (W x H x D) mm		283 x 318 x 372	
Cutting (max.) mm		120 x 12	
Weight kg		20.5	
Also required			
Electro-hydraulic pump	1 pc(s).	4055.720	644
Foot-switch	1 pc(s).	4055.712	644
Accessories			
Ride-up roller	2 pc(s).	4055.714	645

Busbar machining CW 120-M



Female dies Page 643 **Male dies** Page 643 **Accessories** Page 644

The mobile product solution for busbar machining is ideal for the precise, fast and ergonomic bending, punching and cutting of busbars directly at your workstation. The integral precision laser facilitates the cutting and bending process.

Design:

- Electric protractor
- Mandrel R10
- Bending die
- External 230 V power inlet
- Pull-out side support extension for long rails
- External hydraulic connection for almost all machining options
- 4 castors (2 lockable)
- Drawer pull-outs
- Integral hydraulic pump
- Laser pointer (auxiliary laser), beam power laser class 1
- Length end stop, pull-out

Benefits:

- High level of bending and punching accuracy
- Simple tool changes
- Flexible use in the workshop

Machinable material:

- Copper
- Aluminium

Supply includes:

- Busbar machining, mobile CW 120-M
- Foot-switch

Note:

- With a Z bend, the length of the short side depends on the material thickness
- For punching, slots of up to a max. of 21 x 18 mm are also supported
- Slot tools available on request
- We reserve the right to make technical modifications

Model No.	Packs of	4055.800	Page
Machine dimensions (W x H x D) mm		1380 x 1270 x 945	
Support surface (W x D) mm		811 x 1211	
Working height mm		974	
Power consumption kW		2.2	
Electrical connection V, Hz		230, 50/60	
Permissible operating pressure (p. max.) bar		700	
Bending (max.) mm		120 x 12	
Bending angle (max.) °		90	
Bending/side length (min.) mm		50	
Z-bending (min.) mm		72	
Punching (max.) mm		6.6 x 21.5	
Punching/material thickness (max.) mm		12	
Cutting (max.) mm		120 x 12	
Length stop (max.) mm		1224	
Weight kg		390.0	
Accessories			
Hydraulic hose	1 pc(s).	4055.807	645
Hydraulic cylinder	1 pc(s).	4055.806	645
Male and female dies for slots	1 pc(s).	4055.791	644

Accessories

for busbar machining CW 120

Male dies

Male dies for punching round holes in busbars.

Machinable material:

- Copper

Thread	Diameter mm	Material thickness (max.) mm	Packs of	Model No.
M6	6.6	10	1 pc(s).	4055.740
M8	9	12	1 pc(s).	4055.741
M8	9.5	12	1 pc(s).	4055.742
M10	11	12	1 pc(s).	4055.743
M10	11.5	12	1 pc(s).	4055.744
M12	13.5	12	1 pc(s).	4055.745
M12	14	12	1 pc(s).	4055.746
M16	17.5	12	1 pc(s).	4055.747
M16	18	12	1 pc(s).	4055.748
M20	21	12	1 pc(s).	4055.749
M20	21.5	12	1 pc(s).	4055.750



! Also required:

- Busbar bending and hole-punching unit CW 120-S, see page 640
- Busbar machining CW 120-M, see page 642
- Female dies, see page 643

Female dies

The female dies should be used in combination with the respective male die. This allows round holes to be punched in busbars.

Machinable material:

- Copper

Diameter mm	Material thickness (max.) mm	Packs of	Model No.
6.6	10	1 pc(s).	4055.770
9	12	1 pc(s).	4055.771
9.5	12	1 pc(s).	4055.772
11	12	1 pc(s).	4055.773
11.5	12	1 pc(s).	4055.774
13.5	12	1 pc(s).	4055.775
14	12	1 pc(s).	4055.776
17.5	12	1 pc(s).	4055.777
18	12	1 pc(s).	4055.778
21	12	1 pc(s).	4055.779
21.5	12	1 pc(s).	4055.780

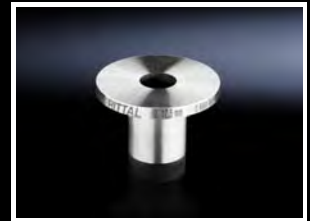

! Also required:

- Busbar bending and hole-punching unit CW 120-S, see page 640
- Male dies, see page 643
- Busbar machining CW 120-M, see page 642

Accessories

for busbar machining CW 120

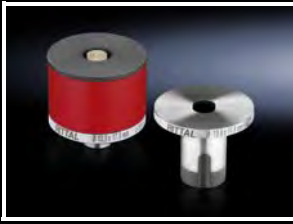

Male and female dies for slots

For incorporating slots up to max. 21 x 18 mm into busbars.

Machinable material:

- Copper

Supply includes:

- Male and female dies for slots

Note:

- Slot tools available on request

Packs of	Model No.
1 pc(s).	4055.791



Also required:

- Busbar bending and hole-punching unit CW 120-S, see page 640
- Busbar machining CW 120-M, see page 642



Electro-hydraulic pump

The electro-hydraulic pump is used to drive products in the CW 120-S product series.

Oil type	HLP 32
Delivery rate (max.) l/min	1.1
Fill volume l	3.2
Work volume l	2.2
Permissible operating pressure (p. max.) bar	700
Machine dimensions (W x H x D) mm	400 x 325 x 335
Space requirements (W x H x D) mm	402 x 342 x 397
Electrical connection V, Hz	230, 50
Power consumption kW	1.3
Rated current A	5.65
Packs of	1 pc(s).
Model No.	4055.720



Foot-switch

Footswitch including connection cable, for using busbar machining equipment from the CW 120-S range.

Packs of	Model No.
1 pc(s).	4055.712

Accessories

for busbar machining CW 120

Hydraulic cylinder

The hydraulic cylinder is ideal for making cut-outs in sheet steel and stainless steel. It is used in conjunction with the hydraulic pump or the CW 120-M.

Design:

- With quick-release coupling

Benefits:

- Flexible use in the workshop
- Ergonomic handling
- Allows you to create cut-outs without the application of force

Machinable material:

- Sheet steel
- Stainless steel

Punching force t	Packs of	Model No.
11	1 pc(s).	4055.806

! Also required:

- Hydraulic hose, see page 645



Hydraulic hose

The hydraulic hose, in combination with the hydraulic cylinder, allows round, square and rectangular cut-outs to be punched in sheet steel and stainless steel. It is used in conjunction with the hydraulic pump or the CW 120-M.

Design:

- Double-walled

Length m	Packs of	Model No.
3	1 pc(s).	4055.807



Ride-up roller for busbars

Ride-up roller for user-friendly handling when cutting busbars to size.

Packs of	Model No.
2 pc(s).	4055.714



Boost productivity at every step

Seamless optimisation of all process stages. The efficiency of panel building and switchgear manufacturing is determined by the quality of productivity, as well as all automated and manual work stages. Digitalization supports the ideal workflow, from engineering right through to production.

Machining

- Significant time savings with the Perforex BC milling centre
- High level of precision with the Perforex BC laser centre
- Less wastage with the Secarex AC 18 cutting centre

Component mounting

- Efficient population of terminal blocks on support rails with the Athex TC 80 CS terminal block assembly centre

Wire processing and wiring

- Faster processes, thanks to fully automated wire processing with the Wire Terminal WT



ENCLOSURES

POWER DISTRIBUTION

CLIMATE CONTROL

FRIEDHELM LOH GROUP



Perfecting the hand tool

High-quality hand tools for professional use in industry and trade,
from page 565



Simplify handling

Ergonomic, efficient handling systems for transport and lifting operations,
from page 606

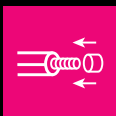

Systematise wire processing

Professional, rational solutions for manual wire machining and processing
Crimping tools, from page 574
Semi-automatic machines, from page 632

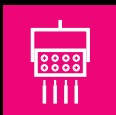

Streamline wiring

To complete the process chain, Rittal Automation Systems are involved in
developing pioneering wiring solutions, right through to full automation.



Automate machining

Fully automated milling or laser machining, plus machining of busbars
and cable ducts
Busbar machining, from page 638



Make component mounting more flexible

Automatic manufacturing and component mounting of terminal strips,
from page 658



ePLAN[®]
electric P8



EPLAN Electric P8 

For project management, documentation and administration of electrical engineering automation projects

ePLAN[®]
data portal



EPLAN Data Portal 

Database with over 500,000 data models for electrical engineering project management

ePLAN[®]
pro panel



EPLAN Pro Panel 

For technological project management and 3D assembly layout of enclosures

Rittal and EPLAN automate panel building

Alongside the Eplan software tools, Rittal Automation Systems provides a comprehensive range of equipment for professional workshop operation. To accelerate individual production stages, we offer a number of automation concepts which may be cost-effectively adapted to suit individual requirements and different sized companies.

Our product spectrum ranges from manual tools through to fully automated machining centres. Depending on the level of automation, you can reduce machining times, as illustrated by the following case study.

Accelerate processes by boosting the level of automation

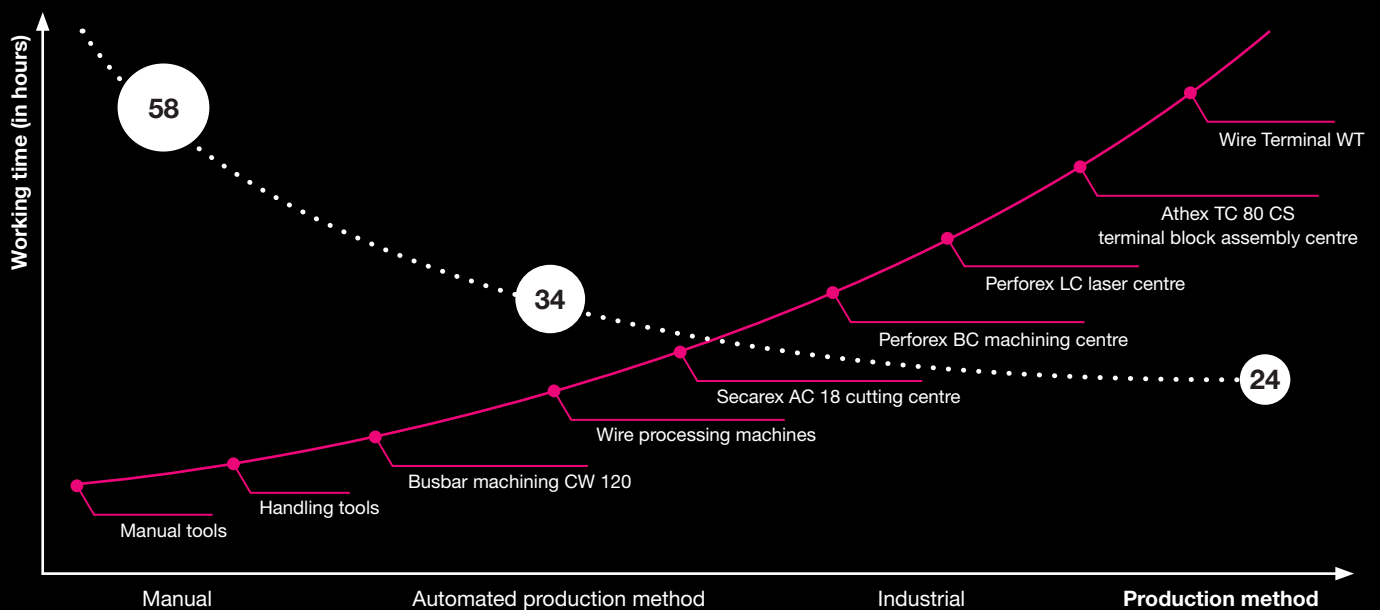

Automation Systems



Cutting centre Secarex AC 18



The Secarex cutting centre is convenient to use and cuts wiring ducts, cable duct covers and support rails to length quickly, precisely and reliably. The integral label printer provides project-specific labelling of the support rails and cable trunking. The cutting centre helps to improve quality, optimise cutting waste, lower costs and accelerate the overall process. Investing in a Secarex cutting centre AC 18 for cutting support rails and wiring ducts to size is cost-effective from just 200 enclosures per annum. In this example, the ROI calculation is approximately 3 years.

- Modern operating solution: 18.5" monitor, top-hat rail industrial PC with i3 processor, and keyboard with trackball
- Data is transferred directly from CAE systems (EPLAN Pro Panel) or Perforex workshop programming, or alternatively, dimensions may be entered manually by the operator
- USB interface



- Special equipment: Optional drawer system

- Five DIN rail sizes in one template



Mousepad support, vertically hinged



Machine operation with keyboard and label printing for project-specific allocation of blanks when using cut optimisation

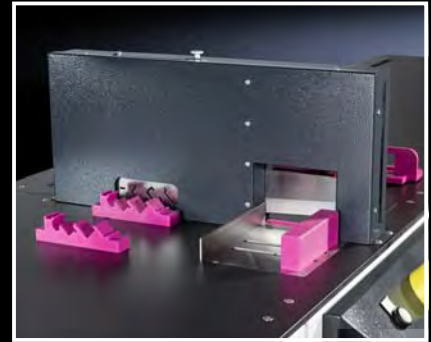

Cut-to-size unit for support rails and wiring ducts

- Safe, two-handed operation for cutting wiring ducts and support rails to size at the push of a button
- Cut optimisation across multiple projects
- Automatic length end stop



- Special equipment: Optional Storage system



Milling centre Perforex BC



Perforex machining centres accelerate your throughput times when machining anything from the smallest enclosures and enclosure panels, right through to large enclosures. The drilling and milling centres in the Perforex BC series allow you to machine any material, including spray-finished sheet and stainless steel as well as aluminium, copper and plastic. The Perforex BC series is characterised by its fast, simple machining. The fully welded machine frame guarantees short throughput times with a consistently high machining quality plus fast, precise and reliable working. A short-term ROI of < 3 years can be achieved from just 150 enclosures per annum.

User-friendly shop-floor programming with central database

- Interface to EPLAN Pro Panel and all common CAD systems
- Processing of the neutral DXF format
- Transfer of configuration data from the Rittal Configuration System (RiCS)

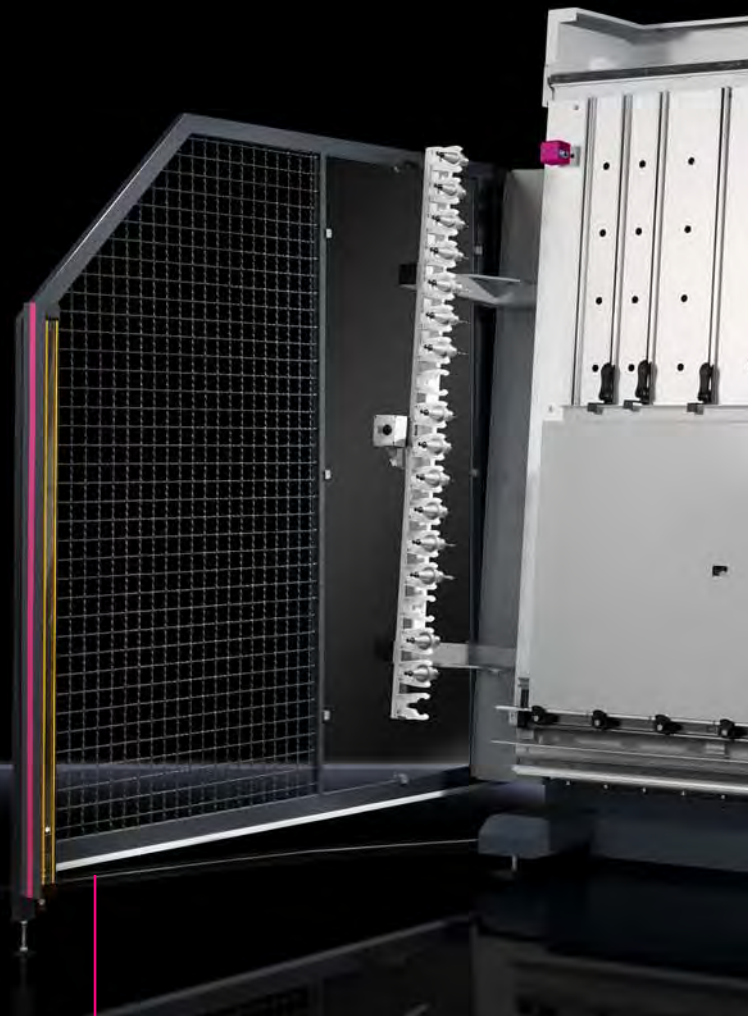

Operational safety

- A light barrier/light array ensures operator safety and correct functioning of the machine
- The machine can be restarted directly after acknowledging the safety function

Performance package

- Faster feed rate for the milling cutter
- Rapid, user-friendly clamping of workpieces
- Dampened vibrations and noise emissions
- Extended tool life
- Shorter processing times

Installation – Maintenance – Servicing

- Short installation and training times
- Maintenance-friendly with easy access
- Global service network

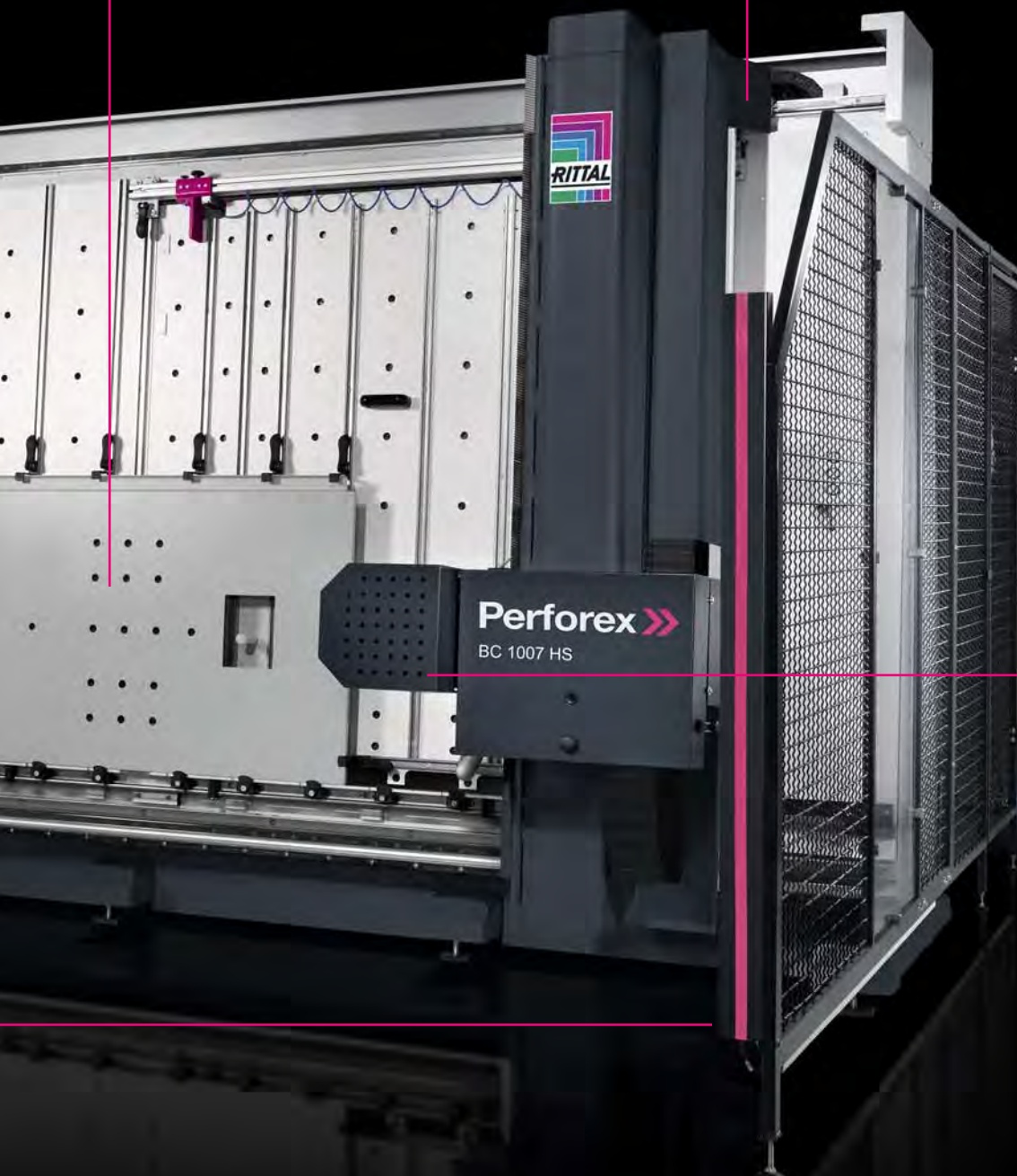

Powerful high-performance spindle

- Up to 23,000 rpm
- Faster processing times
- Higher throughput
- Use of DIN tools and automatic tool checks

Integral swarf extraction in the spindle

- Extraction close to machining
- Less cleaning work
- Fast workpiece changes
- Greater productivity

Laser centre Perforex LC



The 3D laser technology in the Perforex LC is ideally suited for machining stainless steel and sheet steel, as well as powder-coated metals such as enclosure doors, side panels etc. Spray-finished metal parts are cut without any visible paint damage or discolouration, even with delicate contours. What is more, there is no tarnishing of the cut edges when machining stainless steel. It is worth investing in a laser from around 300 enclosures per annum, ideally with a stainless steel proportion of around 30%.

User-friendly shop-floor programming with central database

- Machine operation with 3D visualisation
- Interfaces to EPLAN Pro Panel
- Processing of the neutral DXF format
- Transfer of configuration data from the Rittal Configuration System (RiCS)





Simultaneous machining of five sides

- Less setup time
- Less strain on the operating personnel
- Machining of multiple components in a single operation



Thread tapping option for LC 3030

- Six different thread sizes in the tool magazine
- Automatic change-over of the machine head
- Greater variability in manufacturing



Contactless, low-vibration manufacturing process

- Clean, non-wearing cutting without coolant/lubricant
- Machining speed with stainless steel is several times higher than with conventional milling processes
- No rework required
- Shorter throughput times
- Greater productivity



Simple attachment of enclosures without clamping

- More ergonomic
- Faster population
- Less risk of damage
- Less strain on the operating personnel

Wire Terminal WT fully automated wire processing machine

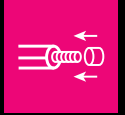

Component wiring is a time-consuming task, accounting for around 50% of the time in panel building and switchgear manufacturing. The compact Wire Terminal 24 or 36 fully automated wire processing machine ensures efficient, cost-effective wire processing. Up to 36 different wires in cross-sections ranging from 0.5 mm² to 2.5 mm² may be processed fully automatically without retooling. The optional print system prints the wires in black or white, then transfers them to downstream process stages via a controlled ordering system capable of accommodating up to 1800 processed wires. All production data can be read and processed via suitable interfaces. Manual logging of wire lists is likewise supported.



- Integral touch display for data processing
- Label printer for wire magazine identification

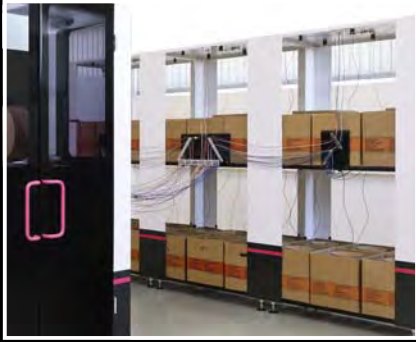

Wire storage

The modular, space-saving wire store and wire routing system for the Wire Terminal. Six wire drums are stored on each of the two levels in a space-saving design. Depending on the number of wires used, the fully automatic wire processing machine may be fitted with additional wire stores (central, left, right), each with space for 12 wire containers.



24 or 36 wires

The Wire Terminal may be fitted with wire guides for 24 or 36 wires. Wires are fed in via a 24-/36-wire feed magazine which is horizontally adjustable and controlled via a servo-motor NC axis. Wires are clamped by a spring-assisted clamp which is pneumatically released during the wire feed process.

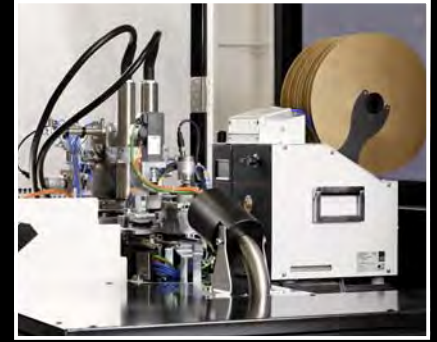

Wire labelling and processing

To ensure optimum positioning of the origin/destination on the wires, the Wire Terminal may be fitted with black, white or both marking systems. Multiple insulation stripping and crimping machines may also be integrated via an optional lift.



Selection of wire magazines

The pre-processed wires can be sequentially stored in 13 wire rails by cross-section and by other project-specific criteria.



Wire Cart

The optional Wire Cart allows assembled wires to be processed directly at the workstation on a project-specific basis. It can also accommodate tools and provide for adaptation of a monitor. The integral storage system can be used for more wires.



Smart Wiring

EPLAN Smart Wiring is ideal for efficient wire processing.

Design

- For fully automatic processing of wire lists for wire assembly
- Suitable wire stores are selected depending on the number of wires
- When using multiple crimping machines for different cross-sections, the machine may be fitted with a lift option

Benefits

- Processes are 8 times faster, thanks to fully automated wire processing with individual wire printing and order-picking
- Fully interlinked, from the E-CAD tool through to the production processes
- Consistently high quality
- Amortisation period of 2.5 years from a minimum of 300 enclosures per annum

Machinable material

- Fine-wire copper cables to DIN VDE 0295 Category 5

Terminal block assembly centre Athex TC 80 CS



The Athex TC 80 CS terminal block assembly centre handles data from EPLAN Pro Panel or manually configured XML formats. During machining, support rails from the buffer store are measured and automatically cut to size, then marked on the underside with a needle engraver for order-picking / project-planning. In a subsequent operation, the terminals required are either fitted directly on the terminal strip with a gripper system, or optionally labelled with the laser marking system prior to positioning. The finished terminal strip is ejected from the machine via the sorting unit and can be removed. Users with a high volume of terminal blocks (> 760,000 units per annum) will achieve ROI within approximately 4 years.

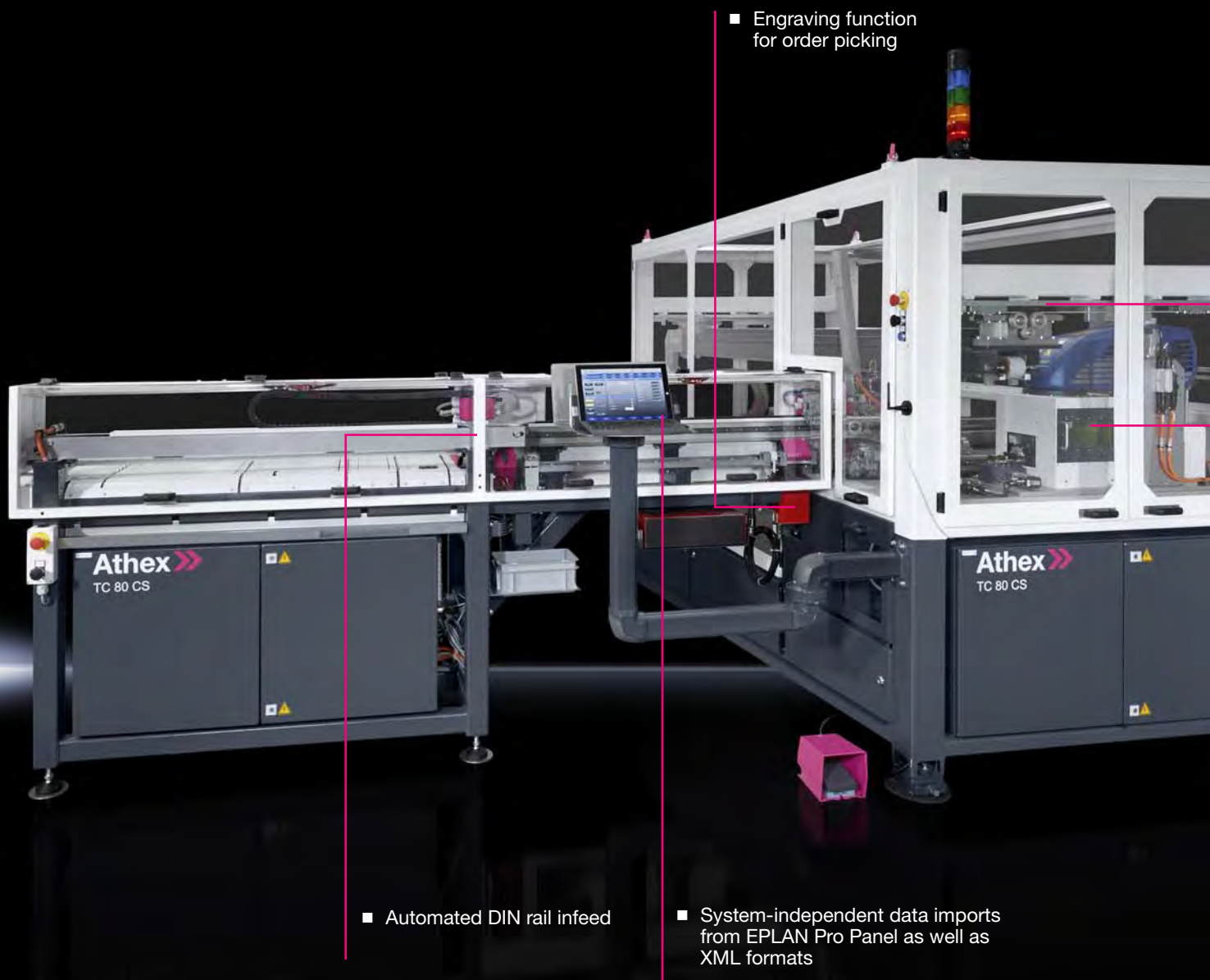

Design

- Material store for support rail versions TS 35/7.5 and TS 35/15 to EN 60 715
- Automatic measurement and cutting unit
- Needle marking system for labelling the support rail undersides
- Fully automated gripper system for populating the support rails with terminal blocks
- Laser marking system for labelling the terminals and components
- Sorting and buffer stores for the finished terminal strips



Sorting unit and buffer stores for the finished terminal strips

- Upgradable with up to 80 magazine slots
- Up to 800 terminals per hour (excluding printing)
- Terminal types from all well-known manufacturers may be used



Stocking of up to 80 magazines for terminal blocks, miniature fuse-breakers etc.



Automated terminal block assembly and labelling with a laser marking system

- Labelling during assembly with a laser marking system

Rittal – The System.

Faster – better – everywhere.



ENCLOSURES

POWER DISTRIBUTION

CLIMATE CONTROL

FRIEDHELM LOH GROUP

For information on the delivery times of your preferred Model No., please go to:

www.rittal.com

Individual configuration options:

www.rittal.com/configurators



IT INFRASTRUCTURE from page 662

IT rack systems from page 672

Overview	684
VX IT with vented doors, with 482.6 mm (19") mounting angles, standard	686
VX IT with vented doors, with 482.6 mm (19") mounting angles, dynamic	689
VX IT with vented doors, pre-configured, with 482.6 mm (19") mounting angles, standard	691
VX IT with glazed door, with 482.6 mm (19") mounting angles, standard	692
VX IT with glazed door, with 482.6 mm (19") mounting angles, dynamic	695
VX IT with glazed door, IP 55, with 482.6 mm (19") mounting angles, standard	696
VX IT with glazed door, pre-configured, with 482.6 mm (19") mounting angles, standard	697
VX IT with glazed door, pre-configured, with 482.6 mm (19") swing frame	698
VX IT with glazed door, IP 55, empty rack	699
Cable management rack VX IT	700
Network rack TE 8000, width 600 mm	704
Network rack TE 8000, width 800 mm	705
Network rack TE 8000, pre-configured	706
Network rack TE 8000, vented	707
Distributor rack TE 8000, open	708
Distributor rack, Data Rack	709

IT racks from page 672

VerticalBox	712
FlatBox	713
Wall-mounted rack EL, 3-part	715
Wall-mounted rack AX IT	719
Small fibre-optic distributor	720

IT power from page 722

VX25 Ri4Power	724
UPS systems	726
Power distribution rack	728
Power distribution unit	730
Modular power distribution unit	742
Upgrade solutions	753

IT cooling from page 756

Cooling unit Blue e+ IT	762
Liquid cooling unit	766
Liquid cooling package	772
Aisle containment	788
Small cooling units	789
CRAC systems	792
IT chillers	794
Air Handling Unit	796

IT monitoring from page 798

CMC III – Monitoring system	800
CMC III Automatic Door Opening (ADO)	816
Monitor/keyboard unit	822
Fire alarm and extinguisher system	823
IT management software	828

IT solutions from page 832

Edge Data Center	834
Micro Data Center	842
RiMatrix S	848
Data centre container	852
Security room	862
Open Compute Project	866
Software for IT infrastructure	874

Industry 4.0 trends

Data processing close to production

More automation, more data

The digital transformation is revolutionising production. To control production in line with Industry 4.0, all components are now inter-linked and communicate with one another: robots, human/machine interfaces, sensors and actuators, machines, tools and control systems. Their values are compared against their digital twin. This generates vast volumes of data.

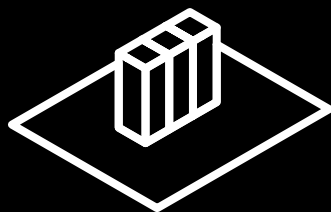

Edge data centres reduce latencies

Large volumes of data generated in the immediate production environment must be processed quickly and reliably. To this end, Rittal offers scalable edge data centres which ensure low latencies, maximum computing power and optimum security.



Private clouds offer security

From the individual sensor to the private cloud: invaluable, success-critical data flows need protective mechanisms to meet escalating security requirements. A combination of edge data centres and private cloud solutions allows customers to decide for themselves who may use their data and to what extent.

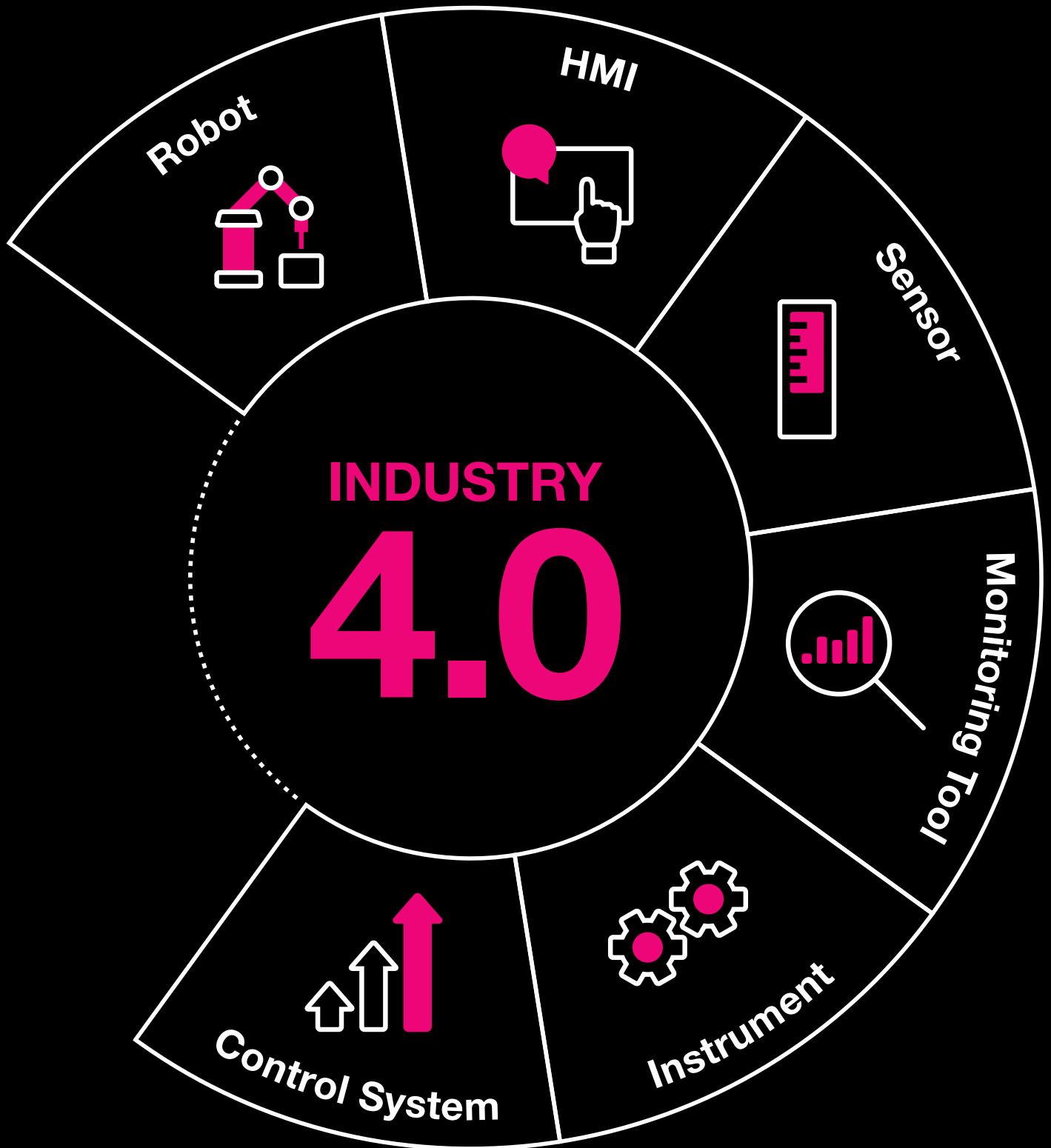

RiMatrix Next Generation

Next Generation IT infrastructure platform

Rittal takes its popular RiMatrix IT infrastructure platform to a new dimension with the RiMatrix NG. IT trends indicate we will be facing enormous challenges in the years to come. Digital twins, autonomous things, artificial intelligence, augmented analytics and smart cities are just a few of the buzzwords that will rely on high-performance networks and powerful data centres. RiMatrix NG is the perfect solution for companies worldwide, covering the full spectrum from small individual rack installations to edge, enterprise, colocation and hyper-scale data centres.

Innovative platform

- RiMatrix NG now includes a number of additional key components, such as predefined data centre modules and built-in OCP technology.
- Our ongoing R&D work keeps us up-to-date with future technology trends.
- Energy-efficient components provide the basis for implementing customised sustainability concepts.

Flexibly adaptable

- RiMatrix NG flexibly supports the IT lifecycle, from planning through to operation and optimisation.
- RiMatrix NG is freely scalable in every dimension, be it output range, installation size, availability or fail-safe operation. The open platform concept supports the addition of certified products and solutions from third-party providers.
- Variable financing models complement the portfolio and support flexible investment decisions.



Fast availability

- Predefined, tried-and-tested solutions such as edge and container data centres reduce the customer input.
- RiMatrix NG is perfectly tailored to the demands of IT components as well as super-ordinate management systems and applications, and supports the prompt implementation of complete solutions (XaaS).

Reliable solutions

- RiMatrix NG is synonymous with tested Rittal quality which meets international standards.
- The new platform is compatible with existing installed systems and guarantees flexible extendibility.
- Documentation and training, plus a comprehensive customer service package, round out the platform concept.

Rittal Competence Centre

Expert teams for the data centre lifecycle

Safeguard long-term efficiency and scalability

Data centres demand long-term action extending far beyond the initial setup. Everything must be modular and flexible to enable it to grow over a period of many years, while still maintaining maximum efficiency. With this in mind, the expert teams at the Rittal Competence Centre IT are happy to support your data projects throughout their entire lifecycle.

The lifecycle IT

Rittal's lifecycle IT helps you to develop state-of-the-art IT landscapes. It defines the periodic lifecycle of data centres at the following stages:

Design

Once the data centre concept has been developed, the solution modules are selected, and the investment (CAPEX) and operating costs (OPEX) are calculated.

Implementation

The physical infrastructure (electricity, cooling, monitoring, security) is assembled. This is followed by commissioning and sign-off of the data centre.

Operation

You may opt to operate the data centre yourself, or use a managed service from Innovo Cloud. You can also link into Innovo's central data centres, e.g. for backup purposes or to cushion peak loads.

Optimization

The efficiency, costs, sustainability and scalability of the installed solution are analysed. This allows us to draw conclusions about the potential for optimising your IT landscape.

Adopting an holistic view of all framework conditions and influencing factors helps to prevent data centre planning errors and develop a future-viable, resilient solution. A flexible, modular data centre architecture means you can respond flexibly to new or modified requirements to ensure that you always operate your data centre at the optimum point. This guarantees permanent savings, not just in relation to investments but also with operating costs. The expert teams at the Rittal IT competence centres have extensive expertise from many years spent working on countless international IT projects. Our specialists will support you with all issues relating to concept development and detailed planning of data centres, calculation of TCO, security aspects, and monitoring and maintenance planning.

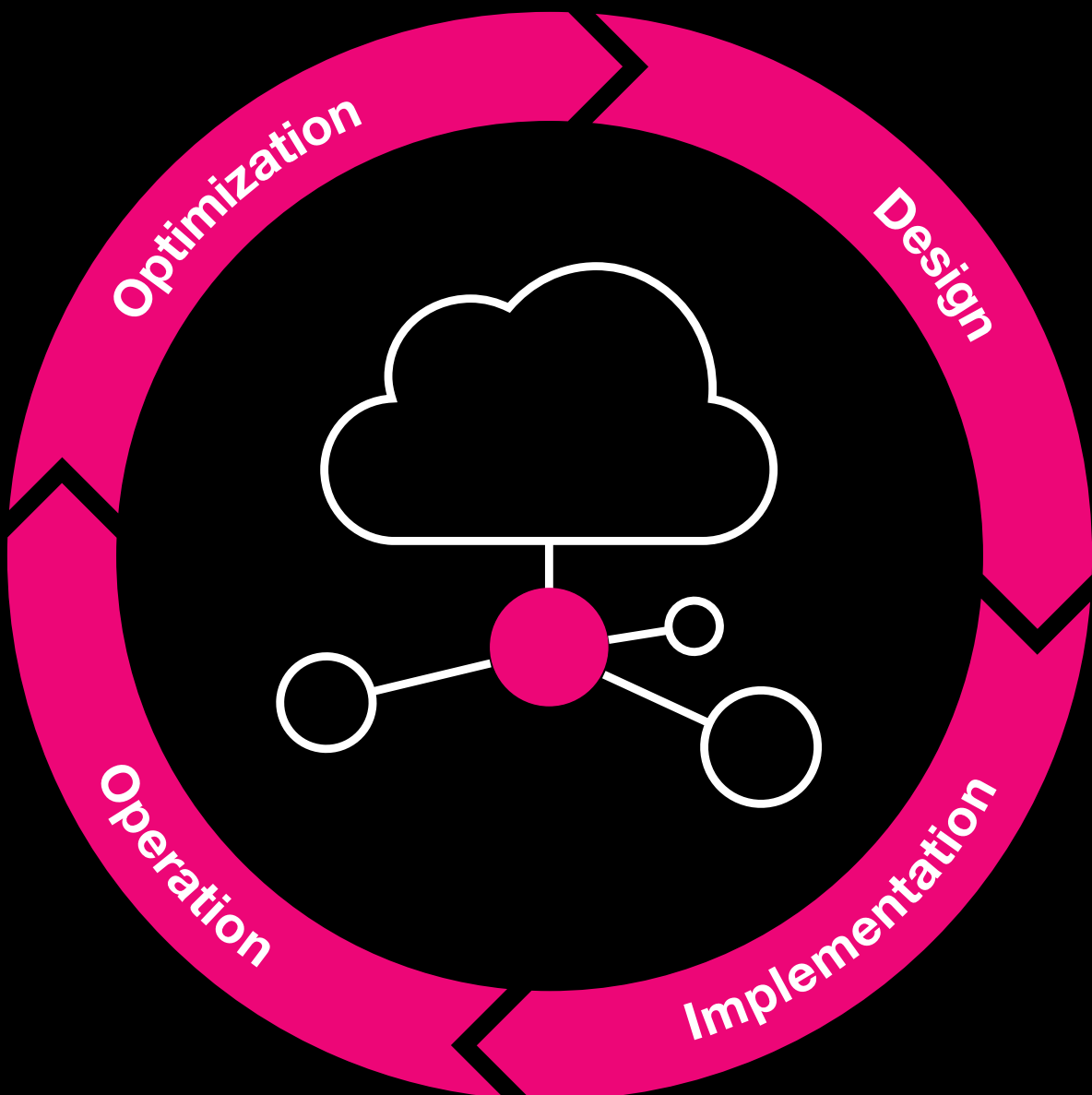

Edge data centres

On-site data management

Production to Industry 4.0 generates huge volumes of data which must be processed and transported extremely rapidly, securely and seamlessly, for example for interaction between machines. This may prove too much for cloud-based solutions. Edge data centres, on the other hand, allow data to be processed in the immediate environment of the production process (i.e. at the edge of the cloud). This helps to boost the level of automation in production directly on site.





Minimal latency

- Autonomous systems such as vehicles and machines must be able to respond quickly to data generated in real time.
- High-performing data networks such as optical fibre connections, as well as 5G connections and edge data centres, are the key technologies in this regard.



System security

- Data privacy is vital and poses a challenge, particularly in distributed systems such as IIoT applications.
- Not only is it necessary to protect personal data, but also product and process data. Digital twin is the buzzword here, because a product's data is just as important as the product itself.



Local data processing

- Smart machines, autonomous systems and robots generate such huge volumes of data that it would be inappropriate to transmit them directly to a core or cloud data centre.
- Within the context of Industry 4.0 applications, as well as in smart cities, edge data centres are indispensable for bringing applications to the point of data generation.



High availability

- The availability of an edge data centre reflects the availability of the application.
- Redundant supply paths, backed-up power supplies and cooling, together with finely-tuned workflows and failover scenarios help to ensure the availability of a solution.



Dynamically scalable systems

- Edge applications are tailored to the customer's requirements. This calls for a high level of flexibility in infrastructure components (IT and OT) as well as in applications.
- For this reason, edge data centres need to be scalable and, in conjunction with the applications, capable of aligning with requirements. Predefined data centre modules that nevertheless offer a high degree of flexibility provide the basis for distributed data centre topologies.



IT infrastructure solutions

Green, reliable and efficient – an example

One of the world's largest data centres is housed in a decommissioned mine at the Lefdal Mine Datacenter (LMD) on the west coast of Norway. The five-storey tunnel system with 75 chambers provides 120,000 square metres of space with a potential total capacity of up to 200 MW. It is one of the most cost-effective, secure, flexible and eco-friendly data centre solutions in Europe. It is powered solely by electricity from renewable sources such as hydropower plants and solar farms, and uses water from the nearby fjord for cooling. The primary circuit is connected to the 565 metre deep fjord, which guarantees unlimited supplies of cold water. Water/water heat exchangers supply the secondary circuit in the mine, keeping the energy needed to cool the container and whitespace solutions to a minimum.



LMD uses IT containers from the Rittal container platform, such as server containers with an output of up to 300 kW. Standardised interfaces for power supply, water connections and the network allows equipment to be incorporated rapidly into the heavy-duty shelving system, where up to three containers may be stacked on top of one another in a tunnel. The container platform is scalable in terms of both output and redundancy, and customer requests are flexibly accommodated.



The tunnels at LMD are also perfectly suited to whitespace solutions. The Rittal security room GSR is used to protect valuable IT components from the harsh mine environment. Infrastructure modules from the aforementioned container solutions are installed here. Individual planning of these areas is supported, making LMD freely scalable in every dimension.

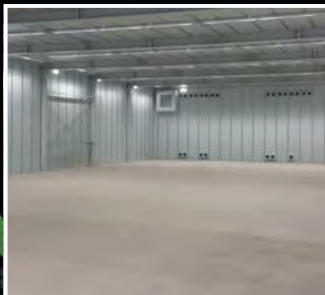

When the Total Cost of Ownership (TCO) is taken into account, LMD is 40 percent cheaper than other data centres in Europe. This is due not only to the attractive electricity price and the use of sea water cooling from the fjord, but also to the outstanding partial PUE (efficiency) of the standardised data centre modules across the full breadth of applications, from memory-intensive storage/backup solutions through to high-performance computing (HPC).

Of course, a comprehensive security concept is also included in the range of services. In this regard, the mine system offers inestimable benefits: the facility is only accessible via well-protected entry points. The rock formation provides natural protection from electromagnetic pulses. Specially trained security staff patrol the entire installation around the clock, 365 days a year. A three-stage authentication process and smart camera systems provide additional security. The installation is certified to Uptime Tier III design and represents one of the most secure data centre solutions in the Nordic market.

Rittal – The System.

Faster – better – everywhere.



IT rack system/racks



Network/server racks VX IT

Product advantages	674
With vented doors, with 482.6 mm (19") mounting angles, standard	686
With vented doors, with 482.6 mm (19") mounting angles, dynamic	689
With vented doors, pre-configured, with 482.6 mm (19") mounting angles, standard	691
With glazed door, with 482.6 mm (19") mounting angles, standard	692
With glazed door, with 482.6 mm (19") mounting angles, dynamic	695
With glazed door, IP 55, with 482.6 mm (19") mounting angles, standard ...	696
With glazed door, pre-configured, with 482.6 mm (19") mounting angles, standard	697
With glazed door, pre-configured, with 482.6 mm (19") swing frame	698
With glazed door, IP 55, empty rack	699

Cable management racks

Product advantages	700
for VX IT	701

Network racks TE 8000

Product advantages	702
Width 600 mm	704
Width 800 mm	705
Pre-assembled	706
Vented	707

Distributor racks

TE 8000 open	708
Data Rack	709

IT racks

Product advantages	710
VerticalBox	712
FlatBox with 482.6 mm (19") mounting angles	713
FlatBox with 482.6 mm (19") mounting frame	714
Wall-mounted enclosure EL, 3-part, pre-configured, with mounting angles	715
Wall-mounted enclosure EL, 3-part, with punched rails and mounting angles	716
Wall-mounted enclosure EL, 3-part, with mounting plate and mounting angles	717
Wall-mounted enclosure AX IT with 482.6 mm (19") mounting angles	719
Small fibre-optic distributor with mounting plate and splicing cassette accommodation	720

Your benefits

Network/server racks

- For individual use as stand-alone installations and data centres
- Complete system solutions for small to large networks
- Maximum configuration versatility and protection for installed equipment
- Simple conversions and use of our extensive modular system ensures flexibility and safeguards your investment

Wall-mounted enclosures

- A comprehensive choice of products – the right enclosure for every application – up to protection category IP 66
- Wide range of sizes available from 3 U to 21 U
- Extensive selection of accessories with "Rittal – The System."
- Fast assembly, modification and simple installation based on the modular principle

Sample applications

- 1 Wall-mounted enclosure EL, see page 715
- 2 VerticalBox, see page 712
- 3 Wall-mounted enclosure AX IT with 482.6 mm (19") mounting angles, see page 719
- 4 VX IT with glazed door for rack climate control, see page 692, base/plinth and installation accessories, see page 880
- 5 VX IT with vented door for room cooling, see page 686, bayed with base/plinth and installation accessories, see page 878
- 6 Small fibre-optic distributor, see page 720



VX IT

The solution for all network and server applications

Whether you need a network rack to house a corridor distributor, or server racks for an edge, cloud or hyperscale data centre, the new VX IT provides the ideal platform and meets all the requirements of a modern IT infrastructure.

Consistent customer focus

The new VX IT is based on a modular concept with a customer-friendly configurator to guide you quickly and easily to a solution that is tailored to your individual requirements. A state-of-the-art production line and optimised logistics ensure fast availability and on-time delivery.

Matching modules

The new VX IT provides the basis for RiMatrix Next Generation, the latest generation to have evolved from our extremely popular Rittal IT system, now with numerous new features and innovative products.

Seamless compatibility

A data centre infrastructure will outlive its individual servers. Compatibility with established RiMatrix systems is therefore crucial. The VX IT and RiMatrix NG are therefore ideal for extending existing data centres and replacing individual components.

Future-proof

We stay abreast of the latest trends and understand what drives experts and companies, enabling us to deliver forward-looking solutions. The VX IT, like the RiMatrix NG, are continuously being refined to keep pace with the challenges of an evolving IT infrastructure.

Comprehensive modular system

For all requirements



Versatility for every application

- Even the standard variants are available in up to 28 sizes (EU series) – 2 widths, 6 heights and 4 depths.
- Select your individual 482.6 mm (19") installation to meet your specific requirements from a comprehensive range of racks, components and accessories plus two different load classes (dynamic or standard, as per the detailed rack specifications) and your chosen 482.6 mm (19") interior installation variant, with maximum load limits of 15,000 N or 18,000 N.

Tailored door concept

The choice of door depends on the spatial conditions and your individual requirements with regard to access, climate control and protection category.

- The new 180° hinge ensures a maximum door opening angle even when bayed plus a large-scale handle system including security lock with profile half-cylinder.
- There is a door to suit every climate control system, be it rack, suite or room cooling.
- New options include an automatic door opener to provide emergency cooling or to ensure rack extinguishing with a gas-based room extinguisher system.
- Glazed doors are available for an optimum view or to ensure a closed climate control zone in conjunction with high-performance cooling applications, such as high-capacity heat exchangers.

Roof concept with the required protection category

The choice of roof solution will depend on your planned cable entry and prescribed protection category, for example:

- One-piece, solid, with a protection category of up to IP 55
- With brush strip on both sides across the entire enclosure depth
- Cable entry via brush strip horizontally at the rear, across the entire enclosure width
- Cable entry in the corner zones via brush strips

User-friendly side panel solutions

Your choice of side panel will depend on the required level of access and the prescribed security and protection category parameters, for example:

- For individual enclosures: Optionally one-piece, multi-piece, horizontally divided, plug-in or vertically divided, hinged
- To finish off an enclosure suite: Multi-piece, screw-fastened or partitions, one-piece, slide-in fixing for physical separation of individual enclosures within an enclosure suite

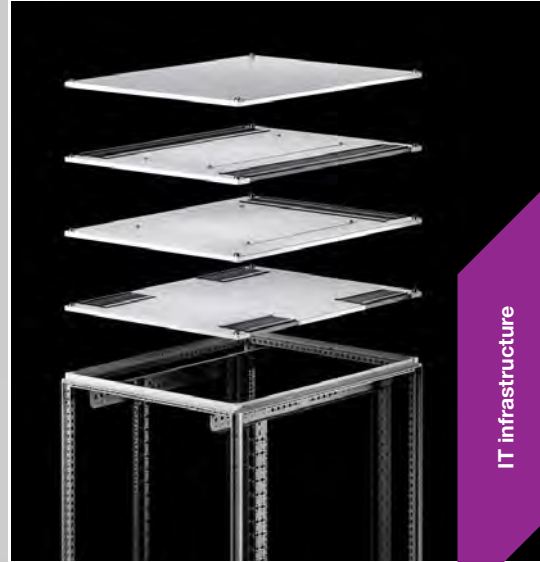
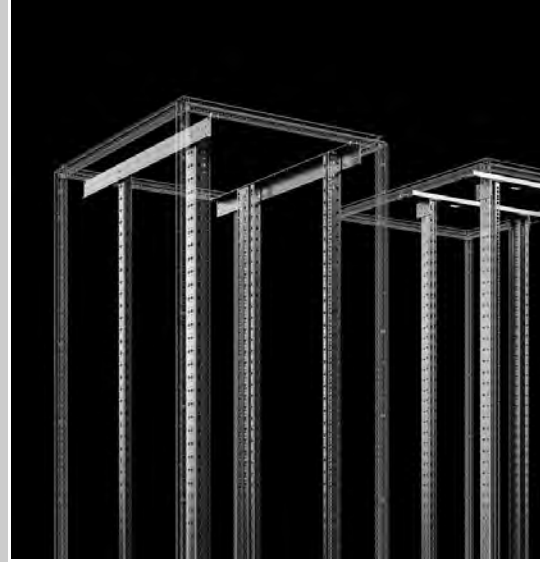

High load capacity

With maximum flexibility



Flexible 482.6 mm (19") installation

Choose from two 482.6 mm (19") installation systems to suit your requirements:

- Standard – Load capacity up to a maximum of 15,000 N or 12,000 N to UL 2416
- Dynamic – Load capacity up to a maximum of 18,000 N or 15,000 N to UL 2416
- Different installation concepts are available for the 482.6 mm (19") mounting angles, depending on the enclosure dimensions. While 600 mm wide racks are mounted directly onto the enclosure frame, in 800 mm wide racks the 482.6 mm (19") levels are mounted on depth stays or cross-members. In this way, alternative mounting dimensions of 21", 23" and 24" are readily accommodated in the enclosure width 800 mm, as are asymmetrical arrangements of the 482.6 mm (19") mounting level. The standard installation variant with cross-members is used with rack depths of up to 800 mm and is ideally suited for use as a network distributor by supporting fast, simple cable management across the entire enclosure width in any height unit.
- An asymmetrical arrangement of the 482.6 mm (19") level gains additional installation space on one side which may be used for optimised cable routing or to integrate a Liquid Cooling Unit (LCU).

Easily extend your existing systems

- The VX IT is also compatible with all existing IT infrastructure solutions assembled with the TS IT and DK TS systems – in other words, further configuration and baying are easily achieved with the VX IT.
- The new baying variant with 3 mm baying gap means that entire racks or liquid cooling packages are easily extracted from the enclosure suite and replaced with updated hardware.

Converting to VX IT couldn't be simpler

- Our smart conversion assistant, available on the Rittal website, allows you to easily convert your existing enclosure systems to the new VX IT system.

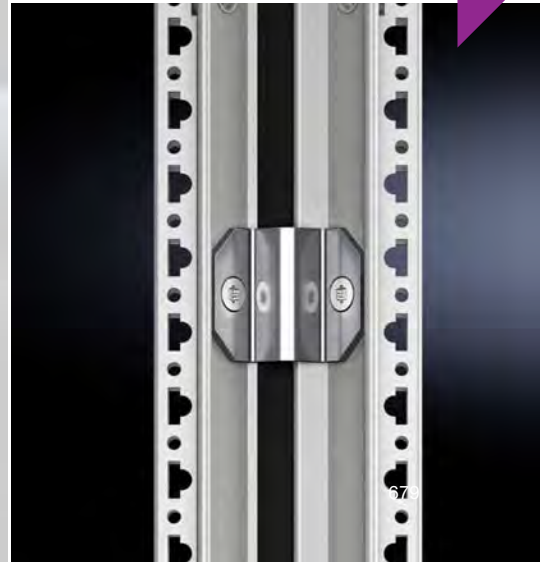
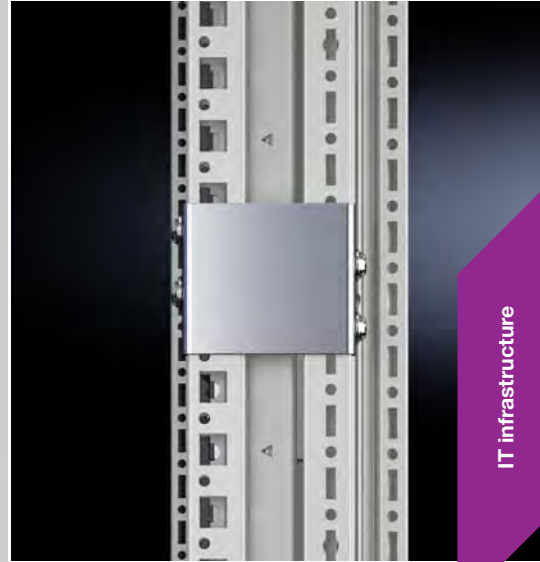
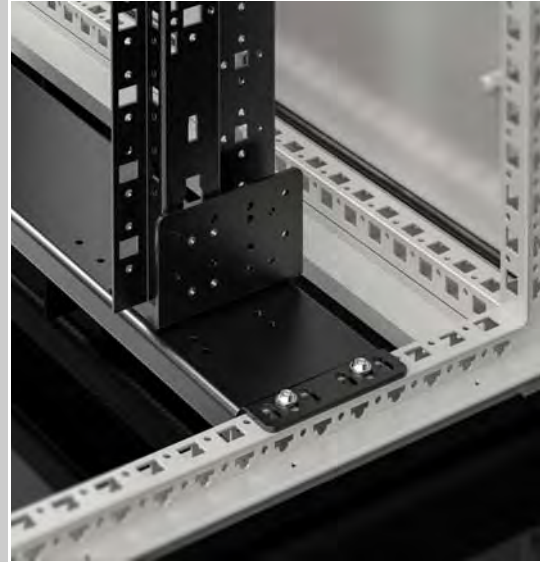
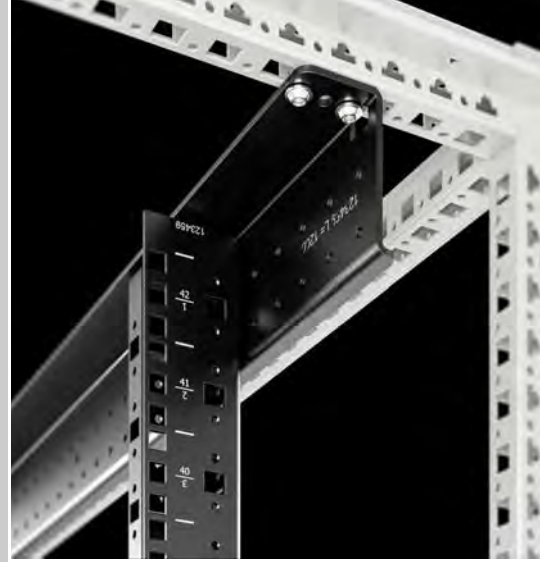

Security and ease of use

Customised at all levels



Roof

- A broad spectrum of individual roof solutions
- Ideal solutions for secure, simple cable entry, even with high cable volumes
- Closed variants for a high protection category of IP 55



Walls

- Divided side panels for problem-free one-man assembly
- Vertically divided, hinged side panels for easy access without dismantling the side panel
- Side panels latched from the inside for superior access protection



Doors

- Vented or solid, to suit the individual climate control concept
- Mechanical and electronic lock systems for optimum security
- Door control systems to automatically open the doors in the event of a cooling failure or for room-based extinguisher systems



Base

- Individual base modules for optimum, secure cable entry from below
- Base/plinth systems with integral cable management solutions



IT infrastructure

Room integration

- Perfectly adapted modules for achieving cold or hot aisle solutions



Interior installation

With unlimited diversity





Power

- Wide range of socket strips and power distribution systems
- Power distribution unit in the zero-U space
- Professional monitoring and link to DCIM software (such as RiZone)
- Measurement of power, current, active and apparent power and power factor

Cooling

- Individual climate control concepts for rack, suite and room cooling up to 53 kW per rack
- Energy-efficient systems help to minimise operating costs

Monitoring

- CMC III enables preventive intervention to reduce the risk of downtime
- Mechanical and electronic lock systems for optimum security

Security

- Fire alarm and extinguisher systems for early fire detection and automatic extinguishing
- Door control systems to automatically open the doors in the event of a cooling failure and for room-based extinguisher systems

Interior installation

- Practical vertical and horizontal air routing inside the rack, even with a high density of ports
- Component shelves, for static or withdrawable installation
- Air blocking systems for optimum air routing inside the rack, adapted to the individual climate control concept



IT infrastructure

Network/server racks VX IT



Door variant, front	Vented door	Vented door	Vented door	
482.6 mm (19") configuration	standard	dynamic	standard	
Material thickness 482.6 mm (19") configuration variant, mm	2.0	2.5	2.0	
Load capacity, static N max., depending on size variant	15000	18000	15000	
Load capacity, static N max., to UL 2416, depending on size variant	12000	15000	12000	
Load capacity, dynamic N max., transport using castors, depending on size variant	10000	10000	10000	
Protection category to IEC 60 529	–	–	–	
Variants	53XX.11X	53XX.81X	53XX.166	

Product-specific scope of supply

Base	Open	■	■	–	
	Multi-piece, solid	–	–	–	
Rear door	One-piece, solid, 130° hinges	–	–	–	
	Vertically divided, from H ≥ 1800 mm, solid, 180° hinges	–	–	–	
	One-piece, vented, 130° hinges	■	■	–	
	Vertically divided, from H ≥ 1800 mm, vented, 180° hinges	■	■	■	
	Rear panel, screw-fastened	–	–	–	
Roof	With cable entry	■	■	■	
	Solid	–	–	–	

Pre-configured

Base/plinth	VX base/plinth, vented	–	–	■	
Base	Solid front, one base module as infill panel	–	–	■	
Walls	One-piece, screw-fastened	–	–	■	

Page	686	689	691	
------	-----	-----	-----	--

Network/server racks VX IT



	Glazed door standard	Glazed door dynamic	Glazed door standard	Glazed door standard	Glazed door swing frame	Glazed door without interior installation
	2.0	2.5	2.0	2.0	2.0	-
	15000	18000	15000	15000	3500	-
	12000	15000	12000	12000	3500	-
	10000	10000	10000	10000	3500	-
	-	-	IP 55	-	-	IP 55
	53XX.12X	53XX.82X	53XX.13X	53XX.15X	53XX.157	53XX.190
	■	■	-	-	-	-
	-	-	■	-	-	■
	■	■	■	■	-	■
	■	■	-	■	-	-
	-	-	-	-	-	-
	-	-	-	-	-	-
	-	-	-	-	■	-
	■	■	-	■	■	-
	-	-	■	-	-	■
	-	-	-	■	■	-
	-	-	-	■	■	-
	692	695	696	697	698	699

Network/server racks VX IT



IT power Page 723 **IT cooling** Page 757 **IT monitoring** Page 799 **System accessories** Page 877

Material:

- Sheet steel
- Aluminium

Surface finish:

- Enclosure frame: Dipcoat-primed
- Interior installation: Spray-finished
- Rear door and roof: Dipcoat-primed, powder-coated
- Front door: Aluminium, anodised/spray-finished

Colour:

- Enclosure frame, rear door and roof: RAL 7035
- Front door: Vertical sections, silver coloured and horizontal sections, RAL 9005
- Interior installation, vent grille at the front: RAL 9005
- Handle and hinges: RAL 9005

Supply includes:

- VX enclosure frame with doors and roof plate
- Aluminium/sheet steel door at the front, vented (vented surface area approx. 85% perforated), 180° hinges
- Sheet steel rear door, vented (vented surface area approx. 85% perforated)
- Lock front and rear: Comfort handle for profile half-cylinders and security lock 3524 E
- Spacers, height 50 mm, to raise the cover plate above the fan cut-out in the roof plate, for passive cooling (supplied loose)
- 12 x 482.6 mm (19") fastener, 1 U, conductive (supplied loose)
- 25 multi-tooth screws, conductive (supplied loose)
- IPPC pallet

Please observe the product-specific scope of supply.

Note:

- Depending on how and where it is sited, the door opening angle may vary for selected applications

Approvals:

- UL
- cUL

Network/server racks VX IT

with vented doors, with 482.6 mm (19") mounting angles, standard

Units U	Packs of	24	24	42	42	42	Page
Width mm		800	800	600	600	600	
Height mm		1200	1200	2000	2000	2000	
Depth mm		800	1000	600	800	1000	
Mounting position of the 482.6 mm (19") level(s)		front and rear	front and rear	front	front and rear	front and rear	
482.6 mm (19") attachment		on the cross-member, screw-fastened at the top and bottom	on depth stays, screw-fastened at the top and bottom	with mounting bracket screw-fastened to the frame at the top and bottom	with mounting bracket screw-fastened to the frame at the top and bottom	with mounting bracket screw-fastened to the frame at the top and bottom	
Max. load capacity (static) per enclosure N		8000	15000	7500	15000	15000	
Max. load capacity (static) per enclosure to UL 2416 N		8000	12000	6000	12000	12000	
Distance between prefitted 482.6 mm (19") levels mm		520	720	–	520	720	
Free mounting space to the 482.6 mm (19") level, front/rear mm		150 / 130	87 / 193	87 / 435	87 / 193	87 / 193	
Model No.	1 pc(s).	5303.114	5304.116	5329.111	5330.113	5308.113	
Product-specific scope of supply, roof plate							
Roof plate, multi-piece, with side cable entry in the depth, double-sided, prepared for fan mounting plate	1 pc(s).	■	■	–	–	–	
Roof plate, multi-piece, removable, for horizontal cable entry at the rear and with covered cut-out for fan mounting plate	1 pc(s).	–	–	■	–	–	
Roof plate, multi-piece, with cable entry in the corner sections front and rear	1 pc(s).	–	–	–	■	■	
Product-specific scope of supply, door							
Sheet steel door, vented, one-piece, 130° hinges	1 pc(s).	■	■	–	–	–	
Sheet steel rear door, vented, vertically divided, 180° hinges	1 pc(s).	–	–	■	■	■	
Accessories							
Side panel, screw-fastened, sheet steel	2 pc(s).	8175.245	8176.245	8106.245	8108.245	8100.245	901
Side panel, horizontally divided	1 pc(s).	–	–	–	–	5301.250	902
Baying connector, external, 3 mm	1 pc(s).	5301.310	5301.310	5301.310	5301.310	5301.310	914
Gland plate set, multi-piece, solid	1 pc(s).	5301.337	5301.344	–	–	5301.338	897

with vented doors, with 482.6 mm (19") mounting angles, standard

Units U	Packs of	42	42	42	42	47	Page
Width mm		600	800	800	800	600	
Height mm		2000	2000	2000	2000	2200	
Depth mm		1200	800	1000	1200	800	
Mounting position of the 482.6 mm (19") level(s)		front and rear	front and rear	front and rear	front and rear	front and rear	
482.6 mm (19") attachment		with mounting bracket screw-fastened to the frame at the top and bottom	on the cross-member, screw-fastened at the top and bottom	on depth stays, screw-fastened at the top and bottom	screw-fastened onto depth stays, top and bottom, and to the support rail on the frame structure	with mounting bracket screw-fastened to the frame at the top and bottom	
Max. load capacity (static) per enclosure N		15000	8000	15000	15000	15000	
Max. load capacity (static) per enclosure to UL 2416 N		12000	8000	12000	12000	12000	
Distance between prefitted 482.6 mm (19") levels mm		720	520	720	720	520	
Free mounting space to the 482.6 mm (19") level, front/rear mm		150 / 330	150 / 130	87 / 193	150 / 330	87 / 193	
Model No.	1 pc(s).	5310.118	5307.114	5309.116	5311.116	5331.113	
Product-specific scope of supply, roof plate							
Roof plate, multi-piece, with cable entry in the corner sections front and rear	1 pc(s).	■	–	–	–	■	
Roof plate, multi-piece, with side cable entry in the depth, double-sided, prepared for fan mounting plate	1 pc(s).	–	■	■	■	–	
Product-specific scope of supply, door							
Sheet steel rear door, vented, vertically divided, 180° hinges	1 pc(s).	■	■	■	■	■	
Accessories							
Side panel, screw-fastened, sheet steel	2 pc(s).	8102.245	8108.245	8100.245	8102.245	8128.245	901
Side panel, horizontally divided	1 pc(s).	5301.254	–	5301.250	5301.254	–	902
Baying connector, external, 3 mm	1 pc(s).	5301.310	5301.310	5301.310	5301.310	5301.310	914
Gland plate set, multi-piece, solid	1 pc(s).	5301.341	5301.337	5301.344	5301.347	–	897

Network/server racks VX IT

with vented doors, with 482.6 mm (19") mounting angles, standard

Units U	Packs of	47	47	47	47	47	Page
Width mm		600	600	800	800	800	
Height mm		2200	2200	2200	2200	2200	
Depth mm		1000	1200	800	1000	1200	
Mounting position of the 482.6 mm (19") level(s)		front and rear	front and rear	front and rear	front and rear	front and rear	
482.6 mm (19") attachment		with mounting bracket screw-fastened to the frame at the top and bottom	with mounting bracket screw-fastened to the frame at the top and bottom	on the cross-member, screw-fastened at the top and bottom	on depth stays, screw-fastened at the top and bottom	screw-fastened onto depth stays, top and bottom, and to the support rail on the frame structure	
Max. load capacity (static) per enclosure N		15000	15000	8000	15000	15000	
Max. load capacity (static) per enclosure to UL 2416 N		12000	12000	8000	12000	12000	
Distance between prefitted 482.6 mm (19") levels mm		720	720	520	720	720	
Free mounting space to the 482.6 mm (19") level, front/rear mm		87 / 193	150 / 330	150 / 130	87 / 193	150 / 330	
Model No.	1 pc(s).	5313.113	5315.118	5312.114	5314.116	5316.116	
Product-specific scope of supply, roof plate							
Roof plate, multi-piece, with cable entry in the corner sections front and rear	1 pc(s).	■	■	–	–	–	
Roof plate, multi-piece, with side cable entry in the depth, double-sided, prepared for fan mounting plate	1 pc(s).	–	–	■	■	■	
Product-specific scope of supply, door							
Sheet steel rear door, vented, vertically divided, 180° hinges	1 pc(s).	■	■	■	■	■	
Accessories							
Side panel, screw-fastened, sheet steel	2 pc(s).	8120.245	8122.245	8128.245	8120.245	8122.245	901
Side panel, horizontally divided	1 pc(s).	5301.257	5301.261	–	5301.257	5301.261	902
Baying connector, external, 3 mm	1 pc(s).	5301.310	5301.310	5301.310	5301.310	5301.310	914
Gland plate set, multi-piece, solid	1 pc(s).	5301.338	5301.341	5301.337	5301.344	5301.347	897



IT power Page 723 IT cooling Page 757 IT monitoring Page 799 System accessories Page 877

Material:

- Sheet steel
- Aluminium

Surface finish:

- Enclosure frame: Dipcoat-primed
- Interior installation: Spray-finished
- Rear door and roof: Dipcoat-primed, powder-coated
- Front door: Aluminium, anodised/spray-finished

Colour:

- Enclosure frame, rear door and roof: RAL 7035
- Front door: Vertical sections, silver coloured and horizontal sections, RAL 9005
- Interior installation, vent grille at the front: RAL 9005
- Handle and hinges: RAL 9005

Supply includes:

- VX enclosure frame with doors and roof plate
- Aluminium/sheet steel door at the front, vented (vented surface area approx. 85% perforated), 180° hinges
- Sheet steel rear door, vented (vented surface area approx. 85% perforated), vertically divided, 180° hinges
- Lock front and rear: Comfort handle for profile half-cylinders and security lock 3524 E
- Spacers, height 50 mm, to raise the cover plate above the fan cut-out in the roof plate, for passive cooling (supplied loose)
- 12 x 482.6 mm (19") fastener, 1 U, conductive (supplied loose)

- 25 multi-tooth screws, conductive (supplied loose)
 - IPPC pallet
- Please observe the product-specific scope of supply.

Note:

- Depending on how and where it is sited, the door opening angle may vary for selected applications

Approvals:

- UL
- cUL

with vented doors, with 482.6 mm (19") mounting angles, dynamic

Units U	Packs of	42	42	42	42	Page
Width mm		600	600	800	800	
Height mm		2000	2000	2000	2000	
Depth mm		1000	1200	1000	1200	
Mounting position of the 482.6 mm (19") level(s)		front and rear	front and rear	front and rear	front and rear	
482.6 mm (19") attachment		with mounting bracket screw-fastened to the frame at the top and bottom	with mounting bracket screw-fastened to the frame at the top and on depth stays at the bottom	on depth stays, screw-fastened at the top and bottom	on depth stays, screw-fastened at the top and bottom	
Max. load capacity (static) per enclosure N		18000	18000	18000	18000	
Max. load capacity (static) per enclosure to UL 2416 N		15000	15000	15000	15000	
Distance between prefitted 482.6 mm (19") levels mm		700	725	700	725	
Free mounting space to the 482.6 mm (19") level, front/rear mm		87 / 213	150 / 325	87 / 213	150 / 325	
Model No.	1 pc(s).	5308.813	5310.818	5309.816	5311.816	
Note on Model No.		-	-	-	-	
Product-specific scope of supply, roof plate						
Roof plate, multi-piece, with cable entry in the corner sections front and rear	1 pc(s).	■	■	-	-	
Roof plate, multi-piece, with side cable entry in the depth, double-sided, prepared for fan mounting plate	1 pc(s).	-	-	■	■	
Accessories						
Side panel, screw-fastened, sheet steel	2 pc(s).	8100.245	8102.245	8100.245	8102.245	901
Side panel, horizontally divided	1 pc(s).	5301.250	5301.254	5301.250	5301.254	902
Baying connector, external, 3 mm	1 pc(s).	5301.310	5301.310	5301.310	5301.310	914
Gland plate set, multi-piece, solid	1 pc(s).	5301.338	5301.341	5301.344	5301.347	897

Network/server racks VX IT

with vented doors, with 482.6 mm (19") mounting angles, dynamic

Units U	Packs of	47	47	47	47	Page
Width mm		600	600	800	800	
Height mm		2200	2200	2200	2200	
Depth mm		1000	1200	1000	1200	
Mounting position of the 482.6 mm (19") level(s)		front and rear	front and rear	front and rear	front and rear	
482.6 mm (19") attachment		with mounting bracket screw-fastened to the frame at the top and bottom	with mounting bracket screw-fastened to the frame at the top and on depth stays at the bottom	on depth stays, screw-fastened at the top and bottom	on depth stays, screw-fastened at the top and bottom	
Max. load capacity (static) per enclosure N		18000	18000	18000	18000	
Max. load capacity (static) per enclosure to UL 2416 N		15000	15000	15000	15000	
Distance between prefitted 482.6 mm (19") levels mm		700	725	700	725	
Free mounting space to the 482.6 mm (19") level, front/rear mm		87 / 213	150 / 325	87 / 213	150 / 325	
Model No.	1 pc(s).	5313.813	5315.818	5314.816	5316.816	
Note on Model No.		-	-	-	-	
Product-specific scope of supply, roof plate						
Roof plate, multi-piece, with cable entry in the corner sections front and rear	1 pc(s).	■	■	-	-	
Roof plate, multi-piece, with side cable entry in the depth, double-sided, prepared for fan mounting plate	1 pc(s).	-	-	■	■	
Accessories						
Side panel, screw-fastened, sheet steel	2 pc(s).	8120.245	8122.245	8120.245	8122.245	901
Side panel, horizontally divided	1 pc(s).	5301.257	5301.261	5301.257	5301.261	902
Baying connector, external, 3 mm	1 pc(s).	5301.310	5301.310	5301.310	5301.310	914
Gland plate set, multi-piece, solid	1 pc(s).	5301.338	5301.341	5301.344	5301.347	897

with vented doors, with 482.6 mm (19") mounting angles, dynamic

Units U	Packs of	52	52	52	52	Page
Width mm		600	600	800	800	
Height mm		2450	2450	2450	2450	
Depth mm		1000	1200	1000	1200	
Mounting position of the 482.6 mm (19") level(s)		front and rear	front and rear	front and rear	front and rear	
482.6 mm (19") attachment		with mounting bracket screw-fastened to the frame at the top and bottom	with mounting bracket screw-fastened to the frame at the top and on depth stays at the bottom	on depth stays, screw-fastened at the top and bottom	on depth stays, screw-fastened at the top and bottom	
Max. load capacity (static) per enclosure N		18000	18000	18000	18000	
Max. load capacity (static) per enclosure to UL 2416 N		15000	15000	15000	15000	
Distance between prefitted 482.6 mm (19") levels mm		700	725	700	725	
Free mounting space to the 482.6 mm (19") level, front/rear mm		87 / 213	150 / 325	87 / 213	150 / 325	
Model No.	1 pc(s).	5334.813	5332.818	5335.816	5333.816	
Note on Model No.		Minimum order quantity = 10 pc(s).	Minimum order quantity = 10 pc(s).	Minimum order quantity = 10 pc(s).	Minimum order quantity = 10 pc(s).	
Product-specific scope of supply, roof plate						
Roof plate, multi-piece, with cable entry in the corner sections front and rear	1 pc(s).	■	■	-	-	
Roof plate, multi-piece, with side cable entry in the depth, double-sided, prepared for fan mounting plate	1 pc(s).	-	-	■	■	
Accessories						
Side panel, screw-fastened, sheet steel		-	-	-	-	
Side panel, horizontally divided	1 pc(s).	5301.264	5301.265	5301.264	5301.265	902
Baying connector, external, 3 mm	1 pc(s).	5301.310	5301.310	5301.310	5301.310	914
Gland plate set, multi-piece, solid	1 pc(s).	5301.338	5301.341	5301.344	5301.347	897



IT power Page 723 IT cooling Page 757 IT monitoring Page 799 System accessories Page 877

Material:

- Sheet steel
- Aluminium
- Plastic

Surface finish:

- Enclosure frame: Dipcoat-primed
- Interior installation: Spray-finished
- Rear door and roof: Dipcoat-primed, powder-coated
- Front door: Aluminium, anodised/spray-finished

Colour:

- Enclosure frame, rear door and roof: RAL 7035
- Front door: Vertical sections, silver coloured and horizontal sections, RAL 9005
- Interior installation, vent grille at the front, base/plinth: RAL 9005
- Handle and hinges: RAL 9005

Supply includes:

- VX enclosure frame with doors and roof plate
- Aluminium/sheet steel door at the front, vented (vented surface area approx. 85% perforated), 180° hinges
- Sheet steel rear door, vented (vented surface area approx. 85% perforated), vertically divided, 180° hinges
- Lock front and rear: Comfort handle for profile half-cylinders and security lock 3524 E
- 482.6 mm (19") mounting angle, standard, variably screw-fastened to depth stays at the top and bottom
- Side panels, one-piece, for screw fastening
- Roof plate, multi-piece, with side cable entry in the depth, double-sided, prepared for fan mounting plate
- Base module mounted at front as infill panel
- Base/plinth system VX, 100 mm, vented
- Base/plinth corner pieces and trim panels, sides, screw-fastened
- Base/plinth trim panels, front and rear plus corner and bay-ing covers supplied loose
- 4 levelling feet, M12, including base/plinth adaptor (supplied loose)
- Spacers, height 50 mm, to raise the cover plate above the fan cut-out in the roof plate, for passive cooling (supplied loose)
- 12 x 482.6 mm (19") fastener, 1 U, conductive (supplied loose)
- 25 multi-tooth screws, conductive (supplied loose)
- 4 combination rails for inner and outer mounting level, to fit rack depth (supplied loose)
- 10 cable shunting rings, metal, 125 x 65 mm (supplied loose)
- IPPC pallet

Note:

- Depending on how and where it is sited, the door opening angle may vary for selected applications

Approvals:

- UL
- cUL

with vented doors, pre-configured, with 482.6 mm (19") mounting angles, standard

Units U	Packs of	42	Page
Width mm		800	
Height mm		2000	
Height including base/plinth mm		2100	
Depth mm		1000	
Max. load capacity (static) per enclosure N		15000	
Max. load capacity (static) per enclosure to UL 2416 N		12000	
Distance between prefitted 482.6 mm (19") levels mm		720	
Free mounting space to the 482.6 mm (19") level, front/rear mm		87 / 193	
Model No.	1 pc(s).	5309.166	
Accessories			
Fan mounting plate	1 pc(s).	5502.020	790
Cable route	1 pc(s).	5302.120	1066

Network/server racks VX IT



IT power Page 723 IT cooling Page 757 IT monitoring Page 799 System accessories Page 877

Material:

- Sheet steel
- Aluminium
- Glazed door: Single-pane safety glass, 3 mm

Surface finish:

- Enclosure frame: Dipcoat-primed
- Interior installation: Spray-finished
- Rear door and roof: Dipcoat-primed, powder-coated
- Front door: Aluminium, anodised/spray-finished

Colour:

- Enclosure frame, rear door and roof: RAL 7035
- Front door: Vertical sections, silver coloured and horizontal sections, RAL 9005
- Interior installation: RAL 9005
- Handle and hinges: RAL 9005

Supply includes:

- VX enclosure frame with doors and roof plate
- Glazed aluminium door at the front, 180° hinges
- Lock front and rear: Comfort handle for profile half-cylinders and security lock 3524 E

- Spacers, height 50 mm, to raise the cover plate above the fan cut-out in the roof plate, for passive cooling (supplied loose)
 - 12 x 482.6 mm (19") fastener, 1 U, conductive (supplied loose)
 - 25 multi-tooth screws, conductive (supplied loose)
 - IPPC pallet
- Please observe the product-specific scope of supply.

Note:

- Depending on how and where it is sited, the door opening angle may vary for selected applications

Approvals:

- UL
- cUL

with glazed door, with 482.6 mm (19") mounting angles, standard

Units U	Packs of	15	24	24	24	38	Page
Width mm		600	600	800	800	600	
Height mm		800	1200	1200	1200	1800	
Depth mm		600	600	800	1000	600	
Mounting position of the 482.6 mm (19") level(s)		front	front	front and rear	front and rear	front	
482.6 mm (19") attachment		with mounting bracket screw-fastened to the frame at the top and bottom	with mounting bracket screw-fastened to the frame at the top and bottom	on the cross-member, screw-fastened at the top and bottom	on depth stays, screw-fastened at the top and bottom	with mounting bracket screw-fastened to the frame at the top and bottom	
Max. load capacity (static) per enclosure N		7500	7500	8000	15000	7500	
Max. load capacity (static) per enclosure to UL 2416 N		6000	6000	8000	12000	6000	
Distance between prefitted 482.6 mm (19") levels mm		–	–	520	720	–	
Free mounting space to the 482.6 mm (19") level, front/rear mm		87 / 435	87 / 435	150 / 130	87 / 193	87 / 435	
Model No.	1 pc(s).	5325.121	5326.121	5303.124	5304.126	5327.121	
Product-specific scope of supply, roof plate							
Roof plate, multi-piece, with horizontal cable entry at the rear and prepared for fan mounting plate	1 pc(s).	■	■	–	–	■	
Roof plate, multi-piece, with side cable entry in the depth, double-sided, prepared for fan mounting plate	1 pc(s).	–	–	■	■	–	
Product-specific scope of supply, door							
Sheet steel rear door, solid, one-piece, 130° hinges	1 pc(s).	■	■	■	■	–	
Sheet steel rear door, solid, vertically divided, 180° hinges	1 pc(s).	–	–	–	–	■	
Accessories							
Side panel, screw-fastened, sheet steel	2 pc(s).	8173.245	8170.245	8175.245	8176.245	8186.245	901
Side panel, horizontally divided		–	–	–	–	–	
Baying connector, external, 3 mm	1 pc(s).	5301.310	5301.310	5301.310	5301.310	5301.310	914
Gland plate set, multi-piece, solid	1 pc(s).	–	–	5301.337	5301.344	–	897

Network/server racks VX IT

with glazed door, with 482.6 mm (19") mounting angles, standard

Units U	Packs of	38	38	42	42	Page
Width mm		600	800	600	600	
Height mm		1800	1800	2000	2000	
Depth mm		800	800	600	800	
Mounting position of the 482.6 mm (19") level(s)		front and rear	front and rear	front	front and rear	
482.6 mm (19") attachment		with mounting bracket screw-fastened to the frame at the top and bottom	on the cross-member, screw-fastened at the top and bottom	with mounting bracket screw-fastened to the frame at the top and bottom	with mounting bracket screw-fastened to the frame at the top and bottom	
Max. load capacity (static) per enclosure N		15000	8000	7500	15000	
Max. load capacity (static) per enclosure to UL 2416 N		12000	8000	6000	12000	
Distance between prefitted 482.6 mm (19") levels mm		520	520	-	520	
Free mounting space to the 482.6 mm (19") level, front/rear mm		87 / 193	150 / 130	87 / 435	87 / 193	
Model No.	1 pc(s).	5328.123	5305.124	5329.121	5330.123	
Product-specific scope of supply, roof plate						
Roof plate, multi-piece, with cable entry in the corner sections front and rear	1 pc(s).	■	-	-	■	
Roof plate, multi-piece, with side cable entry in the depth, double-sided, prepared for fan mounting plate	1 pc(s).	-	■	-	-	
Roof plate, multi-piece, with horizontal cable entry at the rear and prepared for fan mounting plate	1 pc(s).	-	-	■	-	
Product-specific scope of supply, door						
Sheet steel rear door, solid, vertically divided, 180° hinges	1 pc(s).	■	■	■	■	
Accessories						
Side panel, screw-fastened, sheet steel	2 pc(s).	8188.245	8188.245	8106.245	8108.245	901
Side panel, horizontally divided		-	-	-	-	
Baying connector, external, 3 mm	1 pc(s).	5301.310	5301.310	5301.310	5301.310	914
Gland plate set, multi-piece, solid	1 pc(s).	-	5301.337	-	-	897

with glazed door, with 482.6 mm (19") mounting angles, standard

Units U	Packs of	42	42	42	42	Page
Width mm		600	600	800	800	
Height mm		2000	2000	2000	2000	
Depth mm		1000	1200	600	800	
Mounting position of the 482.6 mm (19") level(s)		front and rear	front and rear	front	front and rear	
482.6 mm (19") attachment		with mounting bracket screw-fastened to the frame at the top and bottom	with mounting bracket screw-fastened to the frame at the top and bottom	on the cross-member, screw-fastened to the top and bottom	on the cross-member, screw-fastened to the top and bottom	
Max. load capacity (static) per enclosure N		15000	15000	4000	8000	
Max. load capacity (static) per enclosure to UL 2416 N		12000	12000	4000	8000	
Distance between prefitted 482.6 mm (19") levels mm		720	720	-	520	
Free mounting space to the 482.6 mm (19") level, front/rear mm		87 / 193	150 / 330	150 / 372	150 / 130	
Model No.	1 pc(s).	5308.123	5310.128	5306.122	5307.124	
Product-specific scope of supply, roof plate						
Roof plate, multi-piece, with cable entry in the corner sections front and rear	1 pc(s).	■	■	-	-	
Roof plate, multi-piece, with horizontal cable entry at the rear and prepared for fan mounting plate	1 pc(s).	-	-	■	-	
Roof plate, multi-piece, with side cable entry in the depth, double-sided, prepared for fan mounting plate	1 pc(s).	-	-	-	■	
Product-specific scope of supply, door						
Sheet steel rear door, solid, vertically divided, 180° hinges	1 pc(s).	■	■	■	■	
Accessories						
Side panel, screw-fastened, sheet steel	2 pc(s).	8100.245	8102.245	8106.245	8108.245	901
Side panel, horizontally divided	1 pc(s).	5301.250	5301.254	-	-	902
Baying connector, external, 3 mm	1 pc(s).	5301.310	5301.310	5301.310	5301.310	914
Gland plate set, multi-piece, solid	1 pc(s).	5301.338	5301.341	5301.336	5301.337	897

Network/server racks VX IT

with glazed door, with 482.6 mm (19") mounting angles, standard

Units U	Packs of	42	42	47	47	Page
Width mm		800	800	800	800	
Height mm		2000	2000	2200	2200	
Depth mm		1000	1200	800	1000	
Mounting position of the 482.6 mm (19") level(s)		front and rear	front and rear	front and rear	front and rear	
482.6 mm (19") attachment		on depth stays, screw-fastened at the top and bottom	screw-fastened onto depth stays, top and bottom, and to the support rail on the frame structure	on the cross-member, screw-fastened at the top and bottom	on depth stays, screw-fastened at the top and bottom	
Max. load capacity (static) per enclosure N		15000	15000	8000	15000	
Max. load capacity (static) per enclosure to UL 2416 N		12000	12000	8000	12000	
Distance between prefitted 482.6 mm (19") levels mm		720	720	520	720	
Free mounting space to the 482.6 mm (19") level, front/rear mm		87 / 193	150 / 330	150 / 130	87 / 193	
Model No.	1 pc(s).	5309.126	5311.126	5312.124	5314.126	
Product-specific scope of supply, roof plate						
Roof plate, multi-piece, with side cable entry in the depth, double-sided, prepared for fan mounting plate	1 pc(s).	■	■	■	■	
Product-specific scope of supply, door						
Sheet steel rear door, solid, vertically divided, 180° hinges	1 pc(s).	■	■	■	■	
Accessories						
Side panel, screw-fastened, sheet steel	2 pc(s).	8100.245	8102.245	8128.245	8120.245	901
Side panel, horizontally divided	1 pc(s).	5301.250	5301.254	–	5301.257	902
Baying connector, external, 3 mm	1 pc(s).	5301.310	5301.310	5301.310	5301.310	914
Gland plate set, multi-piece, solid	1 pc(s).	5301.344	5301.347	5301.337	5301.344	897

Network/server racks VX IT



IT power Page 723 IT cooling Page 757 IT monitoring Page 799 System accessories Page 877

Material:

- Sheet steel
- Aluminium
- Glazed door: Single-pane safety glass, 3 mm

Surface finish:

- Enclosure frame: Dipcoat-primed
- Interior installation: Spray-finished
- Rear door and roof: Dipcoat-primed, powder-coated
- Front door: Aluminium, anodised/spray-finished

Colour:

- Enclosure frame, rear door and roof: RAL 7035
- Front door: Vertical sections, silver coloured and horizontal sections, RAL 9005
- Interior installation: RAL 9005
- Handle and hinges: RAL 9005

Supply includes:

- VX enclosure frame with doors and roof plate
 - Glazed aluminium door at the front, 180° hinges
 - Sheet steel rear door, solid, vertically divided, 180° hinges
 - Lock front and rear: Comfort handle for profile half-cylinders and security lock 3524 E
 - Spacers, height 50 mm, to raise the cover plate above the fan cut-out in the roof plate, for passive cooling (supplied loose)
 - 12 x 482.6 mm (19") fastener, 1 U, conductive (supplied loose)
 - 25 multi-tooth screws, conductive (supplied loose)
 - IPPC pallet
- Please observe the product-specific scope of supply.

Note:

- Depending on how and where it is sited, the door opening angle may vary for selected applications

Approvals:

- UL
- cUL

with glazed door, with 482.6 mm (19") mounting angles, dynamic

Units U	Packs of	42	42	42	Page
Width mm		600	800	800	
Height mm		2000	2000	2000	
Depth mm		1000	1000	1200	
Mounting position of the 482.6 mm (19") level(s)		front and rear	front and rear	front and rear	
482.6 mm (19") attachment		with mounting bracket screw-fastened to the frame at the top and bottom	on depth stays, screw-fastened at the top and bottom	on depth stays, screw-fastened at the top and bottom	
Max. load capacity (static) per enclosure N		18000	18000	18000	
Max. load capacity (static) per enclosure to UL 2416 N		15000	15000	15000	
Distance between prefitted 482.6 mm (19") levels mm		700	700	725	
Free mounting space to the 482.6 mm (19") level, front/rear mm		87 / 213	87 / 213	150 / 325	
Model No.	1 pc(s).	5308.823	5309.826	5311.826	
Product-specific scope of supply, roof plate					
Roof plate, multi-piece, with cable entry in the corner sections front and rear	1 pc(s).	■	-	-	
Roof plate, multi-piece, with side cable entry in the depth, double-sided, prepared for fan mounting plate	1 pc(s).	-	■	■	
Accessories					
Side panel, screw-fastened, sheet steel	2 pc(s).	8100.245	8100.245	8102.245	901
Side panel, horizontally divided	1 pc(s).	5301.250	5301.250	5301.254	902
Baying connector, external, 3 mm	1 pc(s).	5301.310	5301.310	5301.310	914
Gland plate set, multi-piece, solid	1 pc(s).	5301.338	5301.344	5301.347	897

Network/server racks VX IT



IT power Page 723 IT cooling Page 757 IT monitoring Page 799 System accessories Page 877

Material:

- Sheet steel
- Aluminium
- Glazed door: Single-pane safety glass, 3 mm

Surface finish:

- Enclosure frame: Dipcoat-primed
- Interior installation: Spray-finished
- Rear door and roof: Dipcoat-primed, powder-coated
- Front door: Aluminium, anodised/spray-finished

Colour:

- Enclosure frame, rear door and roof: RAL 7035
- Front door: Vertical sections, silver coloured and horizontal sections, RAL 9005
- Interior installation: RAL 9005
- Handle and hinges: RAL 9005

Protection category IP to IEC 60 529:

- IP 55 only in conjunction with baying seal or screw-fastened side panels

Supply includes:

- VX enclosure frame with doors and roof plate
- Glazed aluminium door at the front, 180° hinges
- Sheet steel rear door, solid, one-piece, 130° hinges
- Lock front and rear: Comfort handle for profile half-cylinders and security lock 3524 E
- Roof plate, one-piece, solid
- Base tray with gland plate, multi-piece, solid
- Baying seal and sealing kit for gland plates (supplied loose)

- 12 x 482.6 mm (19") fastener, 1 U, conductive (supplied loose)
- 25 multi-tooth screws, conductive (supplied loose)
- IPPC pallet

Note:

- Depending on how and where it is sited, the door opening angle may vary for selected applications

Approvals:

- UL
- cUL

with glazed door, IP 55, with 482.6 mm (19") mounting angles, standard

Units U	Packs of	24	24	42	42	42	42	Page
Width mm		600	800	600	600	800	800	
Height mm		1200	1200	2000	2000	2000	2000	
Depth mm		600	800	600	800	800	1000	
Mounting position of the 482.6 mm (19") level(s)		front	front and rear	front	front and rear	front and rear	front and rear	
482.6 mm (19") attachment		with mounting bracket screw-fastened to the frame at the top and bottom	on the cross-member, screw-fastened at the top and bottom	with mounting bracket screw-fastened to the frame at the top and bottom	with mounting bracket screw-fastened to the frame at the top and bottom	on the cross-member, screw-fastened at the top and bottom	on depth stays, screw-fastened at the top and bottom	
Max. load capacity (static) per enclosure N		7500	8000	7500	15000	8000	15000	
Max. load capacity (static) per enclosure to UL 2416 N		6000	8000	6000	12000	8000	12000	
Distance between prefitted 482.6 mm (19") levels mm		-	520	-	520	520	720	
Free mounting space to the 482.6 mm (19") level, front/rear mm		87 / 435	150 / 130	87 / 435	87 / 193	150 / 130	87 / 193	
Model No.	1 pc(s).	5326.131	5303.134	5329.131	5330.133	5307.134	5309.136	
Accessories								
Side panel, screw-fastened, sheet steel	2 pc(s).	8170.245	8175.245	8106.245	8108.245	8108.245	8100.245	901
Baying connector, external	6 pc(s).	8617.502	8617.502	8617.502	8617.502	8617.502	8617.502	912
Combination rails	4 pc(s).	5302.020	5302.021	5302.020	5302.021	5302.021	5302.022	1063
Cable route	1 pc(s).	-	-	5302.120	5302.120	5302.120	5302.120	1066
Component shelf for frame attachment		see page	see page	see page	see page	see page	see page	1006



IT power Page 723 IT cooling Page 757 IT monitoring Page 799 System accessories Page 877

Material:

- Sheet steel
- Aluminium
- Plastic
- Glazed door: Single-pane safety glass, 3 mm

Surface finish:

- Enclosure frame: Dipcoat-primed
- Interior installation: Spray-finished
- Rear door and roof: Dipcoat-primed, powder-coated
- Front door: Aluminium, anodised/spray-finished

Colour:

- Enclosure frame, rear door and roof: RAL 7035
- Front door: Vertical sections, silver coloured and horizontal sections, RAL 9005
- Interior installation, base/plinth: RAL 9005
- Handle and hinges: RAL 9005

Supply includes:

- VX enclosure frame with doors and roof plate
- Glazed aluminium door at the front, 180° hinges
- Lock front and rear: Comfort handle for profile half-cylinders and security lock 3524 E
- Side panels, one-piece, screw-fastened
- Roof plate, multi-piece, with side cable entry in the depth, double-sided, prepared for fan mounting plate
- Base module mounted at front as infill panel
- Base/plinth system VX, 100 mm, vented
- Base/plinth corner pieces and trim panels, sides, screw-fastened
- Base/plinth trim panels, front and rear plus corner and bay-ing covers supplied loose
- 4 levelling feet, M12, including base/plinth adaptor (supplied loose)
- Spacers to raise the fan cover plate, for passive cooling (supplied loose)
- 12 x 482.6 mm (19") fastener, 1 U, conductive (supplied loose)
- 25 multi-tooth screws, conductive (supplied loose)
- 4 combination rails for inner and outer mounting level, to fit rack depth (supplied loose)
- 10 cable shunting rings, metal, 125 x 65 mm (supplied loose)
- IPPC pallet

Note:

- Depending on how and where it is sited, the door opening angle may vary for selected applications

Please observe the product-specific scope of supply.

with glazed door, pre-configured, with 482.6 mm (19") mounting angles, standard

Units U	Packs of	24	42	42	Page
Width mm		800	800	800	
Height mm		1200	2000	2000	
Height including base/plinth mm		1300	2100	2100	
Depth mm		800	800	1000	
Mounting position of the 482.6 mm (19") level(s)		front and rear	front and rear	front and rear	
482.6 mm (19") attachment		on the cross-member, screw-fastened at the top and bottom	on the cross-member, screw-fastened at the top and bottom	on depth stays, screw-fastened at the top and bottom	
Max. load capacity (static) per enclosure N		8000	8000	15000	
Max. load capacity (static) per enclosure to UL 2416 N		8000	8000	12000	
Distance between prefitted 482.6 mm (19") levels mm		520	520	720	
Free mounting space to the 482.6 mm (19") level, front/rear mm		150 / 130	150 / 130	87 / 193	
Model No.	1 pc(s).	5303.154	5307.154	5309.156	
Product-specific scope of supply, door					
Sheet steel rear door, solid, one-piece, 130° hinges	1 pc(s).	■	-	-	
Sheet steel rear door, solid, vertically divided, 180° hinges	1 pc(s).	-	■	■	
Accessories					
Fan mounting plate	1 pc(s).	5502.020	5502.020	5502.020	790
Combination rails	4 pc(s).	5302.021	5302.021	5302.022	1063
Gland plate set, multi-piece, solid	1 pc(s).	5301.337	5301.337	5301.344	897
Castor module	2 pc(s).	5301.518	5301.518	5301.518	894

Network/server racks VX IT



IT power Page 723 IT cooling Page 757 IT monitoring Page 799 System accessories Page 877

Material:

- Sheet steel
- Aluminium
- Plastic
- Glazed door: Single-pane safety glass, 3 mm

Surface finish:

- Enclosure frame: Dipcoat-primed
- Interior installation: Spray-finished
- Rear panel and roof: Dipcoat-primed, powder-coated
- Front door: Aluminium, anodised/spray-finished

Colour:

- Enclosure frame, rear panel and roof: RAL 7035
- Front door: Vertical sections, silver coloured and horizontal sections, RAL 9005
- Interior installation, base/plinth: RAL 9005
- Handle and hinges: RAL 9005

Supply includes:

- VX enclosure frame with doors and roof plate
- Glazed aluminium door at the front (180°), with comfort handle for profile half-cylinders and security lock 3524 E
- Rear panel
- Roof plate, multi-piece, removable, with side cable entry in the depth and covered cut-out for fan mounting plate
- Base module mounted at front as infill panel
- Swing frame, large, with side trim panel for the installation of 482.6 mm (19") mounting components whilst utilising the full rack height, 130°
- Side panels, one-piece, for screw fastening
- Base/plinth system VX, 100 mm, vented
- Base/plinth corner pieces and trim panels, sides, screw-fastened
- Base/plinth trim panels, front and rear plus corner and bay-ing covers supplied loose
- 4 levelling feet, M12, including base/plinth adaptor (supplied loose)
- Spacers, height 50 mm, to raise the cover plate above the fan cut-out in the roof plate, for passive cooling (supplied loose)
- 12 x 482.6 mm (19") fastener, 1 U, conductive (supplied loose)
- 25 multi-tooth screws, conductive (supplied loose)
- 4 combination rails for inner and outer mounting level, to fit rack depth (supplied loose)
- 10 cable shunting rings, metal, 125 x 65 mm (supplied loose)
- IPPC pallet

Note:

- Depending on how and where it is sited, the door opening angle may vary for selected applications

Approvals:

- UL
- cUL

with glazed door, pre-configured, with 482.6 mm (19") swing frame

Width mm	Packs of	800	Page
Height mm		2000	
Height including base/plinth mm		2100	
Depth mm		800	
Max. load capacity (static) per enclosure N		3500	
Model No.	1 pc(s).	5307.157	
Accessories			
Fan mounting plate	1 pc(s).	5502.020	790
Combination rails	4 pc(s).	5302.021	1063
Cable route	1 pc(s).	5302.120	1066
Gland plate set, multi-piece, solid	1 pc(s).	5301.337	897



IT power Page 723 IT cooling Page 757 IT monitoring Page 799 System accessories Page 877

Material:

- Sheet steel
- Aluminium
- Glazed door: Single-pane safety glass, 3 mm

Surface finish:

- Enclosure frame: Dipcoat-primed
- Rear door and roof: Dipcoat-primed, powder-coated
- Front door: Aluminium, anodised/spray-finished

Colour:

- Enclosure frame, rear door and roof: RAL 7035
- Front door: Vertical sections, silver coloured and horizontal sections, RAL 9005
- Handle and hinges: RAL 9005

Protection category IP to IEC 60 529:

- IP 55 only in conjunction with baying seal or screw-fastened side panels

Supply includes:

- VX enclosure frame with doors and roof plate
- Glazed aluminium door at the front, 180° hinges
- Sheet steel rear door, solid, one-piece, 130° hinges
- Lock front and rear: Comfort handle for profile half-cylinders and security lock 3524 E
- Roof plate, one-piece, solid
- Base tray with gland plate, multi-piece, solid
- Baying seal and sealing kit for gland plates (supplied loose)

- 12 x 482.6 mm (19") fastener, 1 U, conductive (supplied loose)
- 25 multi-tooth screws, conductive (supplied loose)
- IPPC pallet

Note:

- Depending on how and where it is sited, the door opening angle may vary for selected applications

Approvals:

- UL
- cUL

with glazed door, IP 55, empty rack

Width mm	Packs of	600	600	600	600	600	600	Page
Height mm		800	1200	1800	1800	2000	2000	
Depth mm		600	600	600	800	1000	600	
Model No.	1 pc(s).	5325.190	5326.190	5327.190	5328.190	5308.190	5329.190	
Accessories								
Side panel, screw-fastened, sheet steel	2 pc(s).	8173.245	8170.245	8186.245	8188.245	8100.245	8106.245	901
Baying connector, external	6 pc(s).	8617.502	8617.502	8617.502	8617.502	8617.502	8617.502	912
Cable route	1 pc(s).	-	-	-	-	5302.120	5302.120	
Combination rails	4 pc(s).	5302.020	5302.020	5302.020	5302.021	5302.022	5302.020	1063
Component shelf for frame attachment		see page	see page	see page	see page	see page	see page	1006

with glazed door, IP 55, empty rack

Width mm	Packs of	600	600	800	800	800	Page
Height mm		2000	2200	2000	2000	2000	
Depth mm		800	800	600	800	1000	
Model No.	1 pc(s).	5330.190	5331.190	5306.190	5307.190	5309.190	
Accessories							
Side panel, screw-fastened, sheet steel	2 pc(s).	8108.245	8128.245	8106.245	8108.245	8100.245	901
Baying connector, external	6 pc(s).	8617.502	8617.502	8617.502	8617.502	8617.502	912
Cable route	1 pc(s).	5302.120	5302.122	5302.120	5302.120	5302.120	1066
Combination rails	4 pc(s).	5302.021	5302.021	5302.020	5302.021	5302.022	1063
Component shelf for frame attachment		see page	see page	see page	see page	see page	1006

Cable management enclosure

More space for network cabling



The cable management enclosure is the ideal solution when you need to manage large quantities of cables, especially surplus cables. Because it is fitted as standard with six punched sections with mounting flanges, the enclosure is perfectly equipped to accommodate a wide range of cable management systems. The cable management enclosure can also be used for the symmetrical balancing of cold/hot aisle containment.

The benefit to you:

- Optimum integration into VX IT rack suites, 2000 mm high and 1000 / 1200 mm deep
- Doors at the front and rear for easy access
- Fast cable entry in the base and roof section, thanks to integral brush strips



Cable management rack VX IT



Cable management Page 1044 **System accessories** Page 877 **IT monitoring** Page 799 **IT cooling** Page 757

For laying, securing and storing cables or as an empty enclosure with uneven Liquid Cooling Package (LCP) installations.

Applications:

- As a cable management rack between fully configured network and server racks
- As an empty rack for symmetrical balancing in cold/hot aisle containment with an uneven number of LCPs in two enclosure suites
- As a placeholder for easy retrofitting of LCP installations

Benefits:

- Optimum accommodation of surplus cables and structured cable management

Material:

- Sheet steel
- Aluminium

Surface finish:

- Enclosure frame: Dipcoat-primed
- Doors and roof: Dipcoat-primed, powder-coated

Colour:

- Enclosure: RAL 7035
- Front: RAL 9005

Supply includes:

- Enclosure frame with front and rear door
- Aluminium door, front, solid with black designer trim panel, 180° hinges
- Sheet steel rear door, solid, one-piece, 130° hinges
- Lock front and rear: Comfort handle for profile half-cylinders and security lock 3524 E
- 2 roof/base plates, with cut-outs for cable entry via brush strips
- 3 VX punched sections with mounting flanges mounted on the left and right
- Baying seal

Note:

- For positioning at the start/end of an enclosure suite, a side panel will be required

Width mm	Packs of	300	300	Page
Height mm		2000	2000	
Depth mm		1000	1200	
Model No.	1 pc(s).	5380.830	5381.830	
Accessories				
Side panel, horizontally divided	1 pc(s).	5301.250	5301.254	902
Baying connector, external, 3 mm	1 pc(s).	5301.310	5301.310	914
Combination rails	4 pc(s).	5302.022	5302.025	1063
Nylon tape holder	10 pc(s).	5502.155	5502.155	1062
Cable manager	20 pc(s).	5502.405	5502.405	1064
Cable shunting ring		see page	see page	1064
Cable clip		see page	see page	1060
Surplus cable holder	1 pc(s).	7220.500	7220.500	1066
Support	1 pc(s).	7246.500	7246.500	1097

Network racks TE 8000

Efficient and cost-effective



TE 8000 – the flexible network rack

- 482.6 mm (19") network rack, may be dismantled, which uses the 482.6 mm (19") level as its supporting structure
- By removing the doors and side panels, free access is available from all sides
- The entire interior is available to use for IT components, cabling and accessories
- Fast assembly, dismantling and conversion (dismantles fully for transporting to confined locations)



Comprehensive range of accessories for customised interior installation

- AX comfort handle with various lock options
- Brush strip for sealing the cable entries in the roof plate
- Depth-variable cable guide rail
- Universal interior installation with depth-variable attachment
- Direct installation on the 482.6 mm (19") mounting frame



System accessories for assembling a professional IT environment

- Power distribution system (PDU) in a range of sizes and functions
- Enclosure monitoring with the CMC III monitoring system
- Optimum cable management with the Network Cable Organizer (NCO)
- Cooling options for use in the network sector

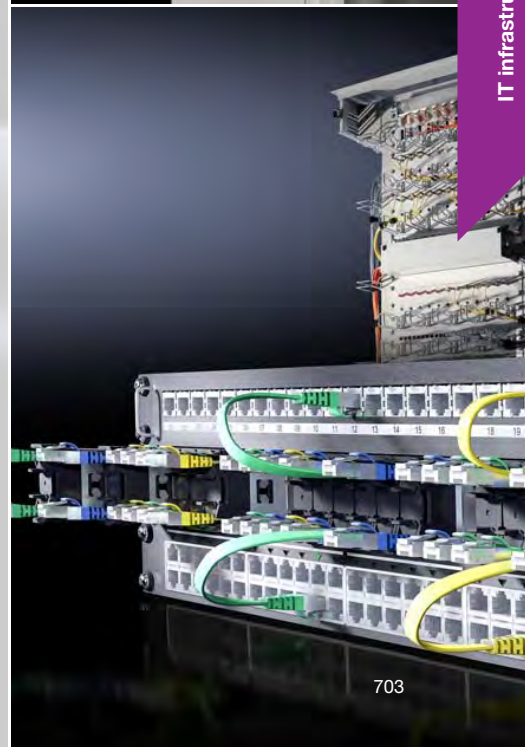

Network racks TE 8000



System accessories Page 877 **IT monitoring** Page 799 **IT cooling** Page 757 **IT power** Page 723

Benefits:

- No frame structure
- Optimum accessibility
- Readily dismantled and therefore easily installed
- Interchangeable door hinge

Material:

- Sheet steel
- Glazed door: Single-pane safety glass, 3 mm

Surface finish:

- Mounting frame: Dipcoat-primed
- Enclosure panels: Powder-coated

Colour:

- RAL 7035

Protection category IP to IEC 60 529:

- IP 20

Max. load capacity (static) per enclosure:

- 4000 N

Supply includes:

- Self-supporting 482.6 mm (19") mounting frames, front and rear, depth-variable
- Glazed door at the front, including 130° hinge, designer handle and security lock 3524 E
- Sheet steel door at the rear, including 130° hinge, security lock 3524 E
- Base frame with maximum cut-out (for optional population with module plates)

- Roof plate including concealed cut-out for cable entry and optional fan
 - 4 levelling feet, M10 (supplied loose)
 - 4 spacers, 20 mm (supplied loose) to raise the roof plate
- Please observe the product-specific scope of supply.

Width 600 mm

Units U	Packs of	11	11	24	24	42	42	Page
Width mm		600	600	600	600	600	600	
Height mm		600	600	1200	1200	2000	2000	
Depth mm		600	800	600	800	600	800	
Distance between prefitted 482.6 mm (19") levels mm		495	495	495	495	495	495	
Free mounting space to the 482.6 mm (19") level, front/rear mm		30 / 30	130 / 130	30 / 30	130 / 130	30 / 30	130 / 130	
Model No.	1 pc(s).	7888.390	7888.410	7888.430	7888.440	7888.500	7888.510	
Product-specific scope of supply								
Side panels, lockable, including security lock 3524 E	2 pc(s).	■	■	■	■	■	■	
Accessories								
482.6 mm (19") fastener, 1 U	24 pc(s).	2090.000	2090.000	2090.000	2090.000	2090.000	2090.000	1097
Side panel		-	-	-	-	-	-	
Baying kit	4 pc(s).	7888.640	7888.640	7888.640	7888.640	7888.640	7888.640	916
Brush kit	2 pc(s).	7888.610	7888.610	7888.610	7888.610	7888.610	7888.610	963
Fan mounting plate	1 pc(s).	5502.020	5502.020	5502.020	5502.020	5502.020	5502.020	790
Complete earthing kit	1 pc(s).	7000.675	7000.675	7000.675	7000.675	7000.675	7000.675	1036
Comfort handle AX	1 pc(s).	2435.100	2435.100	2435.100	2435.100	2435.100	2435.100	939
Component shelf, static installation	1 pc(s).	7000.620	7000.620	7000.620	7000.620	7000.620	7000.620	1008
Component shelf, pull-out	1 pc(s).	7000.625	7000.625	7000.625	7000.625	7000.625	7000.625	1009
Slide rail	2 pc(s).	7963.410	7963.410	7963.410	7963.410	7963.410	7963.410	1088
Socket strip in a plastic housing	1 pc(s).	7000.630	7000.630	7000.630	7000.630	7000.630	7000.630	1041

Width 800 mm

Units U	Packs of	24	42	42	42	Page
Width mm		800	800	800	800	
Height mm		1200	2000	2000	2000	
Depth mm		800	600	800	800	
Distance between prefitted 482.6 mm (19") levels mm		495	495	495	495	
Free mounting space to the 482.6 mm (19") level, front/rear mm		130 / 130	30 / 30	130 / 130	130 / 130	
Model No.	1 pc(s).	7888.460	7888.520	7888.530	7888.532	
Product-specific scope of supply						
Side panels, lockable, including security lock 3524 E	2 pc(s).	■	■	■	–	
Baying kit	4 pc(s).	–	–	–	■	
Accessories						
482.6 mm (19") fastener, 1 U	24 pc(s).	2090.000	2090.000	2090.000	2090.000	1097
Side panel	2 pc(s).	–	–	–	7888.652	903
Baying kit	4 pc(s).	7888.640	7888.640	7888.640	–	916
Brush kit	2 pc(s).	7888.612	7888.612	7888.612	7888.612	963
Fan mounting plate	1 pc(s).	5502.020	5502.020	5502.020	5502.020	790
Complete earthing kit	1 pc(s).	7000.675	7000.675	7000.675	7000.675	1036
Comfort handle AX	1 pc(s).	2435.100	2435.100	2435.100	2435.100	939
Component shelf, static installation	1 pc(s).	7000.620	7000.620	7000.620	7000.620	1008
Component shelf, pull-out	1 pc(s).	7000.625	7000.625	7000.625	7000.625	1009
Slide rail	2 pc(s).	7963.410	7963.410	7963.410	7963.410	1088
Socket strip in a plastic housing	1 pc(s).	7000.630	7000.630	7000.630	7000.630	1041

Rittal – The System.



Comfort handle AX

see page 939

Network racks TE 8000



System accessories Page 877 IT monitoring Page 799 IT cooling Page 757 IT power Page 723

Benefits:

- No frame structure
- Optimum accessibility
- Readily dismantled and therefore easily installed
- Interchangeable door hinge

Material:

- Enclosure: Sheet steel
- Glazed door: Single-pane safety glass, 3 mm

Surface finish:

- Mounting frame: Dipcoat-primed
- Enclosure panels: Powder-coated

Colour:

- RAL 7035

Protection category IP to IEC 60 529:

- IP 20

Max. load capacity (static) per enclosure:

- 4000 N

Supply includes:

- Self-supporting 482.6 mm (19") mounting frames, front and rear, depth-variable
- Glazed door at the front, including 130° hinge, designer handle and security lock 3524 E
- Sheet steel door at the rear, including 130° hinge, security lock 3524 E
- Side panels, lockable, including security lock 3524 E
- Base frame with maximum cut-out (for optional population with module plates)
- Roof plate including concealed cut-out for cable entry and optional fan
- 4 levelling feet, M12, including base/plinth adaptor (supplied loose)
- 4 spacers, 20 mm (supplied loose) to raise the roof plate
- Base/plinth system VX, 100 mm, vented
- Tested frame earthing to IEC 60 950, fitted
- 4 cable guide rails, for cable clamping in the enclosure depth via cable clamps (supplied loose)
- 10 cable shunting rings, metal, 125 x 65 mm (supplied loose)
- 12 x 482.6 mm (19") fastener, 1 U, conductive (supplied loose)
- 50 multi-tooth screws, conductive (supplied loose)
- Brush kit for cable entry in the roof (supplied loose)

Pre-configured

	Packs of	24	42	Page
Units U				
Width mm		800	800	
Height mm		1200	2000	
Height including base/plinth mm		1300	2100	
Depth mm		800	800	
Distance between prefitted 482.6 mm (19") levels mm		495	495	
Free mounting space to the 482.6 mm (19") level, front/rear mm		130 / 130	130 / 130	
Model No.	1 pc(s).	7888.840	7888.850	
Accessories				
482.6 mm (19") fastener, 1 U	24 pc(s).	2090.000	2090.000	1097
Baying kit	4 pc(s).	7888.640	7888.640	916
Fan mounting plate	1 pc(s).	5502.020	5502.020	790
Complete earthing kit	1 pc(s).	7000.675	7000.675	1036
Comfort handle AX	1 pc(s).	2435.100	2435.100	939
Component shelf, static installation	1 pc(s).	7000.620	7000.620	1008
Slide rail	2 pc(s).	7963.410	7963.410	1088
Complete CAT 6 system		see page	see page	1069
IT LED system light	1 pc(s).	7859.000	7859.000	1027
Socket strip in a plastic housing	1 pc(s).	7000.630	7000.630	1041



System accessories Page 877 Power System Module Page 744 IT monitoring Page 799 Climate control Page 449

Benefits:

- No frame structure
- Optimum accessibility
- Readily dismantled and therefore easily installed
- Interchangeable door hinge

Material:

- Sheet steel

Surface finish:

- Mounting frame: Dipcoat-primed
- Enclosure panels: Powder-coated

Colour:

- RAL 7035

Protection category IP to IEC 60 529:

- IP 20

Max. load capacity (static) per enclosure:

- 7000 N

Supply includes:

- Self-supporting 482.6 mm (19") mounting frames, front and rear, depth-variable
- Sheet steel door vented (vented surface area > 67%), front with designer handle, 130° hinge, security lock 3524 E
- Sheet steel door vented (vented surface area > 67%), rear with 130° hinge, security lock 3524 E
- Base frame with maximum cut-out (for optional population with module plates)

- Roof plate including concealed cut-out for cable entry and optional fan
 - 4 levelling feet, M10 (supplied loose)
 - 4 spacers, 20 mm (supplied loose) to raise the roof plate
- Please observe the product-specific scope of supply.

Vented

Units U	Packs of	24	42	42	Page
Width mm		600	600	800	
Height mm		1200	2000	2000	
Depth mm		1000	1000	1000	
Distance between prefitted 482.6 mm (19") levels mm		745	745	745	
Free mounting space to the 482.6 mm (19") level, front/rear mm		80 / 130	80 / 130	80 / 130	
Model No.	1 pc(s).	7888.875	7888.882	7888.892	
Product-specific scope of supply					
Side panels, lockable, including security lock 3524 E	2 pc(s).	■	-	-	
Baying kit	4 pc(s).	-	■	■	
Accessories					
482.6 mm (19") fastener, 1 U	24 pc(s).	2090.000	2090.000	2090.000	1097
Side panel	2 pc(s).	-	7888.653	7888.653	903
Baying kit	4 pc(s).	7888.640	-	-	916
Brush kit	2 pc(s).	7888.610	7888.610	7888.612	963
Complete earthing kit		see page	see page	see page	1036
Comfort handle AX	1 pc(s).	2435.100	2435.100	2435.100	939
Component shelf, static installation	1 pc(s).	5501.665	5501.665	5501.665	1008
Component shelf, pull-out	1 pc(s).	5501.685	5501.685	5501.685	1009
Slide rails, heavy-duty	2 pc(s).	7063.740	7063.740	7063.740	1087
Slide rail, 1 U, depth-variable	2 pc(s).	5302.035	5302.035	5302.035	1088
Combination rails	4 pc(s).	5302.020	5302.020	5302.020	1063
Cable clamp rail, depth-variable	1 pc(s).	5302.044	5302.044	5302.044	1063
Transport castors	4 pc(s).	7000.672	7000.672	7000.672	895
Socket strip in a plastic housing	1 pc(s).	7000.630	7000.630	7000.630	1041

Distributor racks

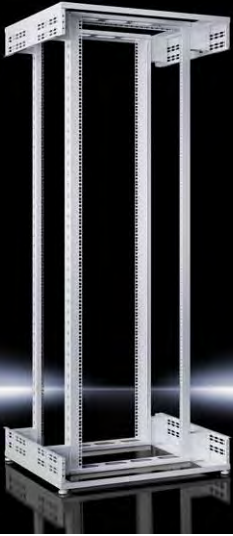

19" installation Page 1079 System accessories Page 877 TE 8000 Page 703

Benefits:

- Optimum accessibility from all sides during assembly and installation
- Unrestricted airflow, due to the open design
- The distance between attachment levels is infinitely variable

Material:

- Sheet steel

Surface finish:

- Powder-coated

Colour:

- RAL 7035

Max. load capacity (static) per enclosure:

- 7000 N

Supply includes:

- Self-supporting mounting frame, with 482.6 mm (19") mounting level front and rear
- Roof-plate, prepared for accommodating cable organisers
- Open base frame with 2 punched sections with mounting flanges for individual configuration fitted in the width
- 4 levelling feet, M10 (supplied loose)

Please observe the product-specific scope of supply.

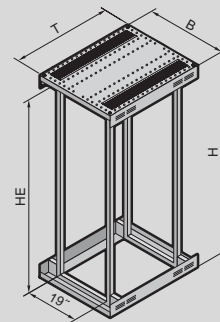

TE 8000 open

Units U	Packs of	42	42	Page
Width mm		600	800	
Height mm		2000	2000	
Depth mm		1000	1000	
Distance between prefitted 482.6 mm (19") levels mm		745	745	
Free mounting space to the 482.6 mm (19") level, front/rear mm		80 / 130	80 / 130	
Model No.	1 pc(s).	7888.940	7888.944	
Product-specific scope of supply				
Roof plate with brush strip, rear horizontal		■	–	
Roof plate with brush strip on both sides		–	■	
Accessories				
Cable organiser	4 pc(s).	7888.950	7888.950	963
482.6 mm (19") fastener, 1 U	24 pc(s).	2090.000	2090.000	1097
Component shelf, static installation	1 pc(s).	5501.665	5501.665	1008
Component shelf, pull-out	1 pc(s).	5501.685	5501.685	1008
Slide rails, heavy-duty	2 pc(s).	7063.740	7063.740	1087
Slide rail, 1 U, depth-variable	2 pc(s).	5302.035	5302.035	1088
Combination rails	4 pc(s).	5302.026	5302.026	1074
Cable route	1 pc(s).	7000.685	7000.685	1066
Cable duct	1 pc(s).	–	–	
Cable routing bars, 482.6 mm (19") attachment	4 pc(s).	7111.224	7111.224	1067
Shunting ring	4 pc(s).	–	7220.600	1064
Cable management panel		see page	see page	1072



19" installation Page 1079 IT monitoring Page 799 Power System Module Page 747 Accessories for Data Rack Page 1079

Material:

- Profile frame, base/plinth: Sheet steel
- Feet: Die-cast zinc

Colour:

- Profile frame, base/plinth: RAL 7035
- Trim panel, feet: RAL 5018

Max. load capacity (static) per 482.6 mm (19") level:

- 1500 N

Supply includes:

- Torsionally stiff profile frame with 482.6 mm (19") punchings
- Stable base/plinth with integral feet, with the option of floor anchoring without base trim panels
- Mounting accessories

Note:

- Order second mounting level separately

Photo shows a configuration example with equipment not included in the scope of supply

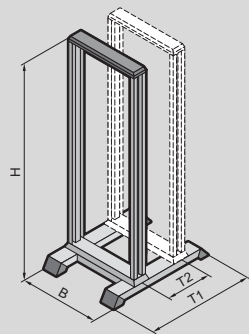

Data Rack

Units U	Packs of	31	36	40	45	Page
Width (B) mm		550	550	550	550	
Height (H) mm		1500	1722	1900	2122	
Depth (T1) mm		750	750	750	750	
Distance from the second mounting level, 50 mm pitch pattern (T2) mm		150 - 350	150 - 350	150 - 350	150 - 350	
Model No.	1 pc(s).	7391.000	7396.000	7400.000	7445.000	
Accessories						
Second pair of mounting angles	1 pc(s).	7296.000	7297.000	7298.000	7299.000	1079
Levelling feet		see page	see page	see page	see page	892
Twin castors	1 pc(s).	7495.000	7495.000	7495.000	7495.000	893
Baying clamp	3 pc(s).	7494.000	7494.000	7494.000	7494.000	1079
Support strips	2 pc(s).	7401.000	7401.000	7401.000	7401.000	1079
Component shelf, pull-out, 2 U	1 pc(s).	5501.635	5501.635	5501.635	5501.635	1010
Component shelf 2 U, static installation		see page	see page	see page	see page	1010
Slide rail, 2 U, static installation, continuous	2 pc(s).	7402.000	7402.000	7402.000	7402.000	1079
Slide rail		see page	see page	see page	see page	1079
Combination rails	4 pc(s).	5302.026	5302.026	5302.026	5302.026	1074
482.6 mm (19") fastener, 1 U	24 pc(s).	2090.000	2090.000	2090.000	2090.000	1097
Keyboard drawer 2 U	1 pc(s).	7281.035	7281.035	7281.035	7281.035	1115

Small IT racks series

Solutions for every application



VerticalBox – the ideal solution for small networks in office environments

- Compact wall-mounted, under-desk or desktop rack
- Free access from all sides to the 482.6 mm (19") level
- Door and side parts may be dismantled with no need for tools
- Passive ventilation as standard, fan may be retrofitted



FlatBox – the space-saving flat-pack solution

- 482.6 mm (19") rack for networks in office environments
- Supplied flat-packed, for easy and fast tool-free assembly
- May be used as wall-mounted or floor-standing enclosure, with free access from all sides
- Passive ventilation as standard, fan may be retrofitted



Wall-mounted enclosure EL, 3-part – optimum access to IT components

- Flexible wall-mounted enclosure in a range of designs and outputs
- Vertically hinged centre part for optimum access to IT equipment
- Suitable for industrial and IT applications
- High protection category up to IP 55



IT infrastructure

AX IT – for use in harsh environments

- Enclosure series to accommodate small IT components
- Data collection and distribution in industrial environments
- High protection category up to IP 66



VerticalBox



System accessories Page 877

Compact 482.6 mm (19") enclosure for small networks.

Benefits:

- May be used as wall-mounted, under-desk or desktop enclosure
- Free access from three sides for interior installation
- Passive ventilation with vent slots
- Rear panel prepared to accommodate a fan
- Freely selectable door hinging
- Space-saving, vertical mounting of 482.6 mm (19") installation components at the side

Material:

- Sheet steel
- Viewing window: Single-pane safety glass, 3 mm

Surface finish:

- Powder-coated

Colour:

- RAL 7035

Supply includes:

- Enclosure with glazed door
- Side panels (1 x fixed, 1 x slot-in) with vent slots
- Knockouts for cable entry via roof or base
- Slot-in rear panel with knockouts for cable entry and fan accommodation
- 482.6 mm (19") mounting level, 5 U, horizontal front and rear, depth-variable, distance between levels 434 – 489 mm
- Security lock 12321 on the door, side and rear panel
- 4 plastic feet, self-adhesive

Units U	Packs of	5	Page
Width mm		300	
Height mm		540	
Depth mm		600	
Model No.	1 pc(s).	7501.000	
Accessories			
482.6 mm (19") fastener, 1 U	24 pc(s).	2090.000	1097
Captive nuts	50 pc(s).	2094.500	1098
Assembly screws	50 pc(s).	7094.130	1098
IT LED system light	1 pc(s).	7859.000	1027
Brush strip	1 pc(s).	7072.200	1055
Complete earthing kit	1 pc(s).	7000.675	1036
Fan expansion kit	1 pc(s).	7980.100	790
Socket strip in a plastic housing	1 pc(s).	7000.630	1041
Socket strip for IEC 320 connectors	1 pc(s).	7240.200	1040
Socket strip in an aluminium duct		see page	1040
Blanking panel, 482.6 mm (19")		see page	1093
Cable management panel		see page	1072
Cable management panel with brush strip	1 pc(s).	5302.202	1074



System accessories Page 877

For flexible use as a wall-mounted or floor-standing enclosure.

Benefits:

- Tool-free quick assembly
- System assembly on the open 482.6 mm (19") frame

Material:

- Sheet steel
- Viewing window: Single-pane safety glass, 3 mm

Surface finish:

- Powder-coated

Colour:

- RAL 7035

Supply includes:

- Flat-packed enclosure
- 1 wall section
- 2 basic supports
- 2 roof/base plates, with cut-outs for cable entry via brush strips
- 2 side panels, lockable
- 1 glazed door, lockable, security lock 3524 E, door hinge point selectable
- Connection components for tool-free, fast assembly
- Earthing kit for system-compatible earthing of all enclosure parts

Please observe the product-specific scope of supply.

Note:

- Max. installation depth: Depth - 58 mm to rear panel
- Max. distance between two 482.6 mm (19") levels: Depth - 104 mm

Photo shows a configuration example with equipment not included in the scope of supply

Design with 482.6 mm (19") mounting angles

Units U	Packs of	6	6	9	9	Page
Width mm		600	600	600	600	
Height mm		358	358	492	492	
Depth mm		400	600	400	600	
Load capacity		max. 300 N	max. 300 N	max. 450 N	max. 450 N	
Model No.	1 pc(s).	7507.000	7507.100	7507.010	7507.110	
Product-specific scope of supply						
482.6 mm (19") mounting frame	1 pc(s).	■	■	■	■	
Accessories						
Base/plinth	1 pc(s).	–	7507.750	–	7507.750	891
Transport castors	4 pc(s).	7000.672	7000.672	7000.672	7000.672	895
Levelling feet	4 pc(s).	7507.740	7507.740	7507.740	7507.740	892
Mounting angles, 482.6 mm (19")	2 pc(s).	7507.706	7507.706	7507.709	7507.709	1085
482.6 mm (19") fastener, 1 U	24 pc(s).	2090.000	2090.000	2090.000	2090.000	1097
Component shelf, pull-out, 2 U	1 pc(s).	5501.635	5501.635	5501.635	5501.635	1010
Component shelf 2 U, static installation		see page	see page	see page	see page	1010
Component shelf, pull-out	1 pc(s).	–	5501.675	–	5501.675	1007
Cover plates for fan panels	6 pc(s).	7507.760	7507.760	7507.760	7507.760	791
Combination rails	4 pc(s).	5302.026	5302.026	5302.026	5302.026	1074
Fan expansion kit		see page	see page	see page	see page	790
Cable management panel	1 pc(s).	5502.205	5502.205	5502.205	5502.205	1072
Cable management panel with brush strip	1 pc(s).	5302.202	5302.202	5302.202	5302.202	1074
Earth rail, horizontal	1 pc(s).	7113.000	7113.000	7113.000	7113.000	1036
Thermostat	1 pc(s).	3110.000	3110.000	3110.000	3110.000	547

FlatBox

Design with 482.6 mm (19") mounting frame

Units U	Packs of	12	12	15	15	18	21	Page
Width mm		600	600	600	700	700	700	
Height mm		625	625	758	758	892	1025	
Depth mm		400	600	400	700	700	700	
Load capacity		max. 600 N	max. 600 N	max. 750 N	max. 750 N	max. 750 N	max. 750 N	
Model No.	1 pc(s).	7507.020	7507.120	7507.030	7507.200	7507.210	7507.220	
Product-specific scope of supply								
482.6 mm (19") mounting angles	2 pc(s).	■	■	■	■	■	■	
Accessories								
Base/plinth	1 pc(s).	–	7507.750	–	7507.755	7507.755	7507.755	891
Transport castors	4 pc(s).	7000.672	7000.672	7000.672	7000.672	7000.672	7000.672	895
Levelling feet	4 pc(s).	7507.740	7507.740	7507.740	7507.740	7507.740	7507.740	892
Mounting angles, 482.6 mm (19")	2 pc(s).	7507.712	7507.712	7507.715	7507.715	7507.718	7507.721	1085
482.6 mm (19") fastener, 1 U	24 pc(s).	2090.000	2090.000	2090.000	2090.000	2090.000	2090.000	1097
Component shelf, pull-out, 2 U	1 pc(s).	5501.635	5501.635	5501.635	5501.635	5501.635	5501.635	1010
Component shelf 2 U, static installation		see page	see page	see page	see page	see page	see page	1010
Component shelf, pull-out	1 pc(s).	–	5501.675	–	5501.675	5501.675	5501.675	1007
Cover plates for fan panels	6 pc(s).	7507.760	7507.760	7507.760	7507.760	7507.760	7507.760	791
Combination rails	4 pc(s).	5302.026	5302.026	5302.026	5302.026	5302.026	5302.026	1074
Fan expansion kit		see page	see page	see page	see page	see page	see page	790
Cable management panel	1 pc(s).	5502.205	5502.205	5502.205	5502.205	5502.205	5502.205	1072
Cable management panel with brush strip	1 pc(s).	5302.202	5302.202	5302.202	5302.202	5302.202	5302.202	1074
Earth rail, horizontal	1 pc(s).	7113.000	7113.000	7113.000	7113.000	7113.000	7113.000	1036
Thermostat	1 pc(s).	3110.000	3110.000	3110.000	3110.000	3110.000	3110.000	547

Rittal – The System.



IT infrastructure selector

www.rittal.com/it-configurator

Wall-mounted enclosures EL, 3-part



System accessories Page 877 **Socket strips** Page 1040 **Wall mounting bracket** Page 958 **Cable clamps** Page 1060

Wall-mounted enclosure with optimum accessibility due to hinged part.

Material:

- Wall and hinged part: Sheet steel, 1.5 mm
- Viewing window: Single-pane safety glass, 3 mm

Surface finish:

- Powder-coated

Colour:

- Wall and hinged part: RAL 7035
- Glazed door: RAL 7035/7015 (slate grey)

Protection category IP to IEC 60 529:

- IP 54 in conjunction with solid gland plate, top and bottom

Supply includes:

- Wall section with solid gland plate at the top and brush strip at the bottom, two vertical mounting rails and C rail, horizontal, for cable clamping
- Hinged part with 25 mm pitch pattern of holes in the front and rear frame, two 482.6 mm (19") mounting angles at the front, infinitely depth-variable, and side outlet filters on the left and right
- Earth rail with star earthing

- Designer glazed door
 - 1 double-kit key no. 5
- Please observe the product-specific scope of supply.

Approvals:

- UL
- cUL

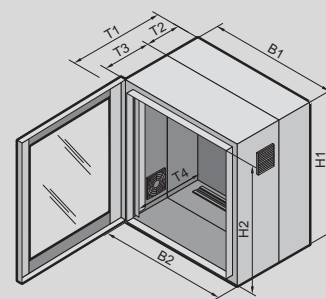

Pre-configured with mounting angles, depth-variable

Units U	Packs of	9	9	15	15	21	21	Page
Width (B1) mm		600	600	600	600	600	600	
Height (H1) mm		478	478	746	746	1012	1012	
Depth (T1) mm		573	673	573	673	573	673	
Clearance width (B2) mm		502	502	502	502	502	502	
Clearance height (H2) mm		415	415	683	683	949	949	
Depth of wall section (T2) mm		135	135	135	135	135	135	
Depth of hinged part (T3) mm		416	516	416	516	416	516	
Max. installation depth (T4) mm		520	620	520	620	520	620	
Load capacity of hinged part (static) N		450	450	750	750	750	750	
Model No.	1 pc(s).	7709.735	7709.535	7715.735	7715.535	7721.735	7721.535	
Product-specific scope of supply								
Wall mounting bracket, 10 mm	4 pc(s).	■	-	■	-	■	-	
Mini-comfort handle for lock inserts	1 pc(s).	■	■	■	■	-	-	
Security lock 3524 E	1 pc(s).	■	■	■	■	■	■	
Wall mounting bracket, 10 mm, reinforced	4 pc(s).	-	■	-	■	-	■	
Comfort handle for lock inserts and 2-point locking	1 pc(s).	-	-	-	-	■	■	
Accessories								
Gland plate for metric cable glands	1 pc(s).	7705.235	7705.235	7705.235	7705.235	7705.235	7705.235	1054
Fan expansion kit	1 pc(s).	7980.100	7980.100	7980.100	7980.100	7980.100	7980.100	790
Spare filter mat	5 pc(s).	3322.700	3322.700	3322.700	3322.700	3322.700	3322.700	535
Component shelf 2 U, static installation		see page	see page	see page	see page	see page	see page	1010
Cable management panel	1 pc(s).	7257.200	7257.200	7257.200	7257.200	7257.200	7257.200	1072
482.6 mm (19") fastener, 1 U	24 pc(s).	2090.000	2090.000	2090.000	2090.000	2090.000	2090.000	1097
Wall mounting bracket	4 pc(s).	2503.020	-	2503.020	-	2503.020	-	967

Wall-mounted enclosures EL, 3-part



System accessories Page 877 **Socket strips** Page 1040 **Wall mounting bracket** Page 958 **Earthing** Page 1033

Wall-mounted enclosure with optimum accessibility due to hinged part.

Material:

- Wall and hinged part: Sheet steel, 1.5 mm
- Viewing window: Single-pane safety glass, 3 mm

Surface finish:

- Powder-coated

Colour:

- Wall and hinged part: RAL 7035
- Glazed door: RAL 7035/7015 (slate grey)

Protection category IP to IEC 60 529:

- IP 55

Supply includes:

- Wall section with solid gland plate, top and bottom, two vertical mounting rails and C rail, horizontal, for cable clamping
 - Hinged part with 25 mm pitch pattern of holes in the front and rear frame, and two 482.6 mm (19") mounting angles at the front, infinitely depth-variable
 - 4 wall mounting brackets 10 mm
 - Designer glazed door
 - 1 double-kit key no. 5
- Please observe the product-specific scope of supply.

Approvals:

- UL
- cUL

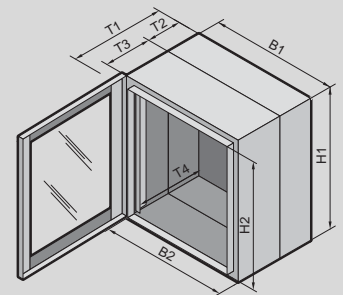

with punched rails and mounting angles, depth-variable

Units U	Packs of	6	9	12	15	21	Page
Width (B1) mm		600	600	600	600	600	
Height (H1) mm		345	478	612	746	1012	
Depth (T1) mm		473	473	473	473	473	
Clearance width (B2) mm		502	502	502	502	502	
Clearance height (H2) mm		282	415	549	683	949	
Depth of wall section (T2) mm		135	135	135	135	135	
Depth of hinged part (T3) mm		316	316	316	316	316	
Max. installation depth (T4) mm		420	420	420	420	420	
Load capacity of hinged part (static) N		300	450	600	750	750	
Model No.	1 pc(s).	7706.135	7709.135	7712.135	7715.135	7721.135	
Product-specific scope of supply							
Mini-comfort handle for lock inserts	1 pc(s).	■	■	■	■	-	
Security lock 3524 E	1 pc(s).	■	■	■	■	■	
Comfort handle for lock inserts and 2-point locking	1 pc(s).	-	-	-	-	■	
Accessories							
Gland plate with brush insert	1 pc(s).	7705.035	7705.035	7705.035	7705.035	7705.035	1055
Gland plate for metric cable glands	1 pc(s).	7705.235	7705.235	7705.235	7705.235	7705.235	1054
Earth rail, horizontal	1 pc(s).	7113.000	7113.000	7113.000	7113.000	7113.000	1036
Component shelf 2 U, static installation		see page	see page	see page	see page	see page	1010
Cable management panel	1 pc(s).	7257.200	7257.200	7257.200	7257.200	7257.200	1072
482.6 mm (19") fastener, 1 U	24 pc(s).	2090.000	2090.000	2090.000	2090.000	2090.000	1097
Component shelf, pull-out, 2 U	1 pc(s).	5501.635	5501.635	5501.635	5501.635	5501.635	1010

Wall-mounted enclosures EL, 3-part



System accessories Page 877 **Socket strips** Page 1040 **Wall mounting bracket** Page 958 **Cable clamps** Page 1060

Wall-mounted enclosure with optimum accessibility due to hinged part.

Material:

- Wall and hinged part: Sheet steel, 1.5 mm
- Viewing window: Single-pane safety glass, 3 mm

Surface finish:

- Powder-coated

Colour:

- Wall and hinged part: RAL 7035
- Glazed door: RAL 7035/7015 (slate grey)

Protection category IP to IEC 60 529:

- IP 55

Supply includes:

- Wall section with solid gland plate, top and bottom and mounting plate (supplied loose).
 - Hinged part with 25 mm pitch pattern of holes in the front and rear frame, and two 482.6 mm (19") mounting angles, front, static installation
 - Designer glazed door
 - 1 double-kit key no. 5
- Please observe the product-specific scope of supply.

Approvals:

- UL
- cUL

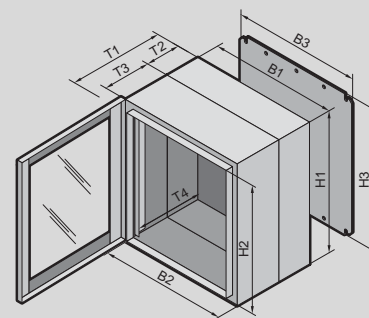

with mounting plate and mounting angles, static installation

Units U	Packs of	3	3	6	6	9	9	Page
Width (B1) mm		600	600	600	600	600	600	
Height (H1) mm		212	212	345	345	478	478	
Depth (T1) mm		373	473	373	473	373	473	
Clearance width (B2) mm		502	502	502	502	502	502	
Clearance height (H2) mm		149	149	282	282	415	415	
Depth of wall section (T2) mm		135	135	135	135	135	135	
Depth of hinged part (T3) mm		216	316	216	316	216	316	
Max. installation depth (T4) mm		320	420	320	420	320	420	
Mounting plate width (B3) mm		485	485	485	485	485	485	
Mounting plate height (H3) mm		165	165	299	299	432	432	
Load capacity of hinged part (static) N		150	150	300	300	450	450	
Model No.	1 pc(s).	2243.605	2253.605	2246.605	2256.605	2249.605	2259.605	
Product-specific scope of supply								
Mini-comfort handle for lock inserts	1 pc(s).	■	■	■	■	■	■	
Security lock 3524 E	1 pc(s).	■	■	■	■	■	■	
Accessories								
Gland plate with brush insert	1 pc(s).	7705.035	7705.035	7705.035	7705.035	7705.035	7705.035	1055
Gland plate for metric cable glands	1 pc(s).	7705.235	7705.235	7705.235	7705.235	7705.235	7705.235	1054
Wall mounting bracket		see page	see page	see page	see page	see page	see page	966
Component shelf 2 U, static installation		-	see page	-	see page	-	see page	1010
Blanking plate, 482.6 mm (19")		see page	see page	see page	see page	see page	see page	1092
Lock insert		see page	see page	see page	see page	see page	see page	941
482.6 mm (19") fastener, 1 U	24 pc(s).	2090.000	2090.000	2090.000	2090.000	2090.000	2090.000	1097
Component shelf, pull-out, 2 U	1 pc(s).	5501.635	5501.635	5501.635	5501.635	5501.635	5501.635	1010

Wall-mounted enclosures EL, 3-part

with mounting plate and mounting angles, static installation

Units U	Packs of	12	12	15	15	21	21	Page
Width (B1) mm		600	600	600	600	600	600	
Height (H1) mm		612	612	746	746	1012	1012	
Depth (T1) mm		373	473	373	473	373	473	
Clearance width (B2) mm		502	502	502	502	502	502	
Clearance height (H2) mm		549	549	683	683	949	949	
Depth of wall section (T2) mm		135	135	135	135	135	135	
Depth of hinged part (T3) mm		216	316	216	316	216	316	
Max. installation depth (T4) mm		320	420	320	420	320	420	
Mounting plate width (B3) mm		485	485	485	485	485	485	
Mounting plate height (H3) mm		565	565	699	699	965	965	
Load capacity of hinged part (static) N		600	600	750	750	750	750	
Model No.	1 pc(s).	2252.605	2262.605	2255.605	2265.605	2261.605	2271.605	
Product-specific scope of supply								
Mini-comfort handle for lock inserts	1 pc(s).	■	■	■	■	–	–	
Security lock 3524 E	1 pc(s).	■	■	■	■	■	■	
Comfort handle for lock inserts and 2-point locking	1 pc(s).	–	–	–	–	■	■	
Accessories								
Gland plate with brush insert	1 pc(s).	7705.035	7705.035	7705.035	7705.035	7705.035	7705.035	1055
Gland plate for metric cable glands	1 pc(s).	7705.235	7705.235	7705.235	7705.235	7705.235	7705.235	1054
Wall mounting bracket		see page	see page	see page	see page	see page	see page	967
Component shelf 2 U, static installation		–	see page	–	see page	–	see page	1010
Blanking plate, 482.6 mm (19")		see page	see page	see page	see page	see page	see page	1092
Lock insert		see page	see page	see page	see page	see page	see page	941
482.6 mm (19") fastener, 1 U	24 pc(s).	2090.000	2090.000	2090.000	2090.000	2090.000	2090.000	1097
Component shelf, pull-out, 2 U	1 pc(s).	5501.635	5501.635	5501.635	5501.635	5501.635	5501.635	1010

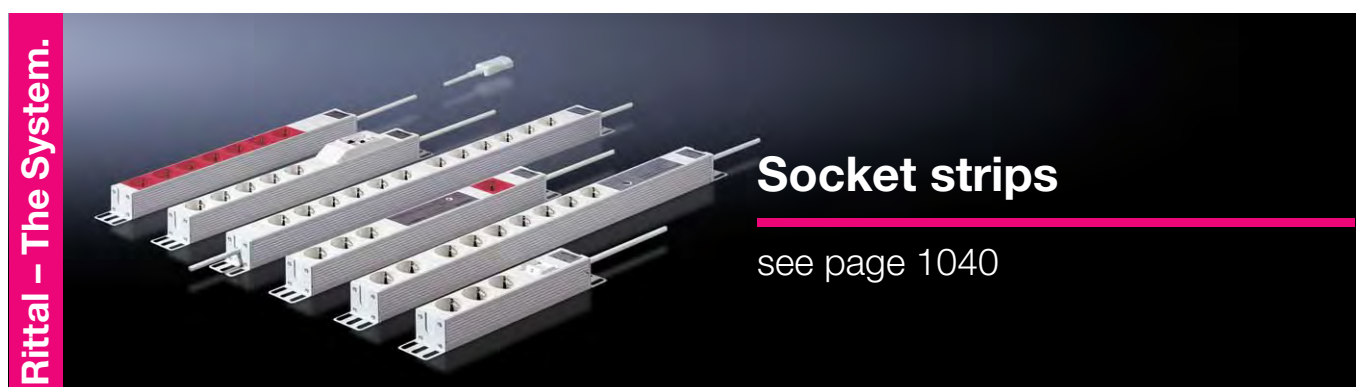

Wall-mounted enclosures AX IT



System accessories Page 877 **Socket strips** Page 1040 **Captive nuts** Page 1002 **Glazed doors** Page 926

IT wall-mounted enclosure based on AX, with high protection category, for use in industrial environments.

Applications:

- IT enclosure for use in industrial environments
- Secure, protected integration of IT directly into your production plant processes

Benefits:

- Fully pre-assembled IT enclosure for immediate accommodation of 482.6 mm (19") IT components, with depth-variable mounting angles
- Welded enclosure construction with all-round solid body ensures maximum protection for installed components, up to IP 66
- Door hinged on the right, may be swapped to the left
- Maximum usable interior volume with an extremely compact design
- Individual interior configuration
- Maximum cut-out in the enclosure base with optimised gland plates increases the space for cable routing by up to 33%
- Convenient cable entry from below via a gland plate with integral brush strip

Installation options:

- Pre-configured mounting bracket including C rail for cable clamping
- Mounting bracket to accommodate a central earth rail
- Mounting bracket for mounting a 482.6 mm (19") socket strip

Material:

- Sheet steel

Surface finish:

- Enclosure and door: Dipcoat primed, powder-coated on the outside, textured paint
- Interior installation: Zinc-plated

Colour:

- RAL 7035

Protection category IP to IEC 60 529:

- IP 10 (up to IP 66 on request)
- Up to IP 66 (depending on the selected gland plate)

Supply includes:

- Pre-assembled IT enclosure with hinged door, of all-round solid construction
- Cam lock with 3 mm double-bit insert
- Gland plate with brush strip
- 482.6 mm (19") mounting angle, front, mounted onto four interior installation rails with depth adjustment in 25 mm pitch pattern
- Mounting bracket
- C rail, fastened to the rear panel

Note:

- Variant with UL approval available on request

with 482.6 mm (19") mounting angles, depth-variable

Units U	Packs of	7	12	15	15	Page
Width mm		600	600	600	600	
Height mm		380	600	760	800	
Depth mm		350	350	350	400	
Max. installation depth mm		278	278	278	316	
Cam locks		1	2	2	2	
Model No.	1 pc(s).	7641.350	7643.350	7645.350	7646.400	
Gland plate, size		7	7	7	7	
Gland plate, qty.		1	1	1	1	

Accessories

Wall angle	4 pc(s).	2505.510	2505.510	2505.510	2505.510	967
Wall mounting bracket		see page	see page	see page	see page	967
Plastic gland plate	1 pc(s).	2567.200	2567.200	2567.200	2567.200	1050
Metal gland plate	1 pc(s).	2577.100	2577.100	2577.100	2577.100	1053
Plastic gland plate	1 pc(s).	2567.300	2567.300	2567.300	2567.300	1052
Component shelf, pull-out, 2 U	1 pc(s).	5501.635	5501.635	5501.635	5501.635	1010
Earth rail, horizontal	1 pc(s).	7113.000	7113.000	7113.000	7113.000	1036
Mini-comfort handle AX	1 pc(s).	2537.100	2537.100	2537.100	2537.100	940
482.6 mm (19") fastener, 1 U	24 pc(s).	2090.000	2090.000	2090.000	2090.000	1097
Cable management panel	1 pc(s).	5502.205	5502.205	5502.205	5502.205	1072
Cable management panel with brush strip	1 pc(s).	5302.202	5302.202	5302.202	5302.202	1074

Small fibre-optic distributor



System accessories Page 877

Benefits:

- Mounting plate with variable accommodation for up to two splicing cassettes (cassette width variable from 92 to 120 mm) and integral anti-twist guard
- Dividing plate with comb strip for cable clamping, to cover the splicing cassette, and to accommodate 2 patch panels
- Cable entry via prepunched knockouts using cable glands (2 x 22.5 mm and 12 x 12.5 mm)

Material:

- Enclosure with cover: Fibreglass-reinforced polycarbonate
- Cover screws: Polyamide
- Insulating bungs: Polyamide
- Foamed-in PU seal

Colour:

- RAL 7035

Protection category IP to IEC 60 529:

- IP 66

Supply includes:

- Enclosure with knockouts for cable glands
- Hinged cover with seal
- 2 cover screws, prepared for a lead seal
- Insulating bungs for wall mounting
- Mounting plate
- Dividing plate
- 12 cable glands M12 x 1.5
- 1 cable gland M20 x 1.5

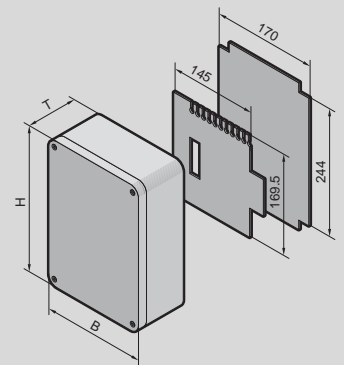

with mounting plate and splicing cassette accommodation

Width (B) mm	Packs of	180	Page
Height (H) mm		254	
Depth (T) mm		90	
Maximum number of fibres (when using patch panels)		24	
Model No.	1 pc(s).	7451.000	
Accessories			
Patch panels for small fibre-optic distributors		see page	1101
Wall mounting bracket	40 pc(s).	9583.000	47

Network rack TE 8000

A comprehensive range of accessories for individual interior installation, see page 877



Rittal – The System.

Faster – better – everywhere.



IT power

VX25 Ri4Power

VX25 Ri4Power724

UPS systems

UPS systems726

Power Distribution Rack

Power Distribution Rack728

Power Distribution Unit

Product advantages730
PDU732
PDU UK.....735
PDU accessories736
PDU overview737
PDU sample applications.....739
PDU technical specifications.....740

Modular PDU (PSM)

Product advantages742
PSM busbar, socket modules744
PSM zero-U space746
PSM measurement bar for CMC III747
PSM socket modules748
PSM measurement modules with CAN bus750

PDU/modular PDU (PSM)

Accessories751

Upgrade solution

RCM measurement module – Inline meter753
Overvoltage protection module, type 3754

Your benefits

- Holistic, systematic energy management concepts
- Comprehensive, complete solutions for power distribution and back-up, consistently modular, and flexibly extendible at any time
- Optimum energy and cost efficiency with maximum availability of the entire system
- Reduced installation, administration and resource costs
- High level of investment security
- All from a single source

Sample applications

- 1 Power distribution, see page 724
- 2 UPS (partner product), see page 726
- 3 Power Distribution Rack PDR, see page 728
- 4 Power Distribution Unit PDU, see page 742



VX25 Ri4Power

The reliable mains infeed for supplying power to data centres



Low-voltage power distribution for data centres

- The VX25 Ri4Power is suitable for use with open and compact circuit-breakers from all well-known manufacturers.
- The busbar systems are dimensioned to your specific requirements with standard copper bars up to 6300 A and individually configured.
- This allows you to achieve a range of infeed sources for data centres (A and B supply) and to connect emergency generators and UPS systems.
- Automatic transfer switches (ATS) may be used to switch between different infeed sources.



Tailored power distribution

- Power supply to individual areas (e.g. server zone, plant room) is implemented in the outgoing section.
- Individual functional spaces, shielded from one another, are created within the outgoing section.
- Each outgoing section can be tailored to your specific requirements and individually populated e.g. with switchgear.
- May also be contacted directly with the multi-terminal busbar systems in data centres using a flexible busbar system.



Simple, efficient planning

- The Rittal Power Engineering planning software makes it much easier to configure section types and equipment. The connector kits are automatically generated and documented when this software is used for project planning.
- Installation of the operating equipment in low-voltage switchgear complies with IEC 61 439 and documented with a design verification. Once the system has been planned with Rittal Power Engineering, the design verification is easily generated.



UPS systems

The ideal power back-up solution for data centres



UPS systems from ABB/Rittal

- Critical loads need to be protected by online double conversion UPS systems. The UPS systems from ABB provide optimum availability and total cost of ownership (TCO), and are based on a complete redundancy concept.
- In the modular UPS series, each UPS module has all the hardware and software needed for autonomous operation. All critical components are available in each individual module, thereby eliminating weak points altogether. This modular approach is known as DPA™ (decentralised parallel architecture).

UPS systems for every application

- The DPA UPScale RI is one of the most compact uninterruptible power supply systems on the market. It can be installed directly into the 482.6 mm (19" level) of the rack and is therefore particularly ideal for customer-specific solutions. DPA UPScale RI is designed for applications in the lower and medium output range with 10kW or 20 kW modules and an overall output of between 10 kW and 80 kW per system.
- Conceptpower DPA S4 is a double conversion UPS system for applications in the medium to high output range. The modular architecture of Conceptpower DPA allows a flexible output configuration with 50 kVA rack-mounted modules, which may be retrofitted to meet a rising power demand. This enables implementation of rack-mounted modular and monoblock systems with an output of up to 3 MW.
- With an efficiency of 97.4% in online double conversion mode, this is one of the most advanced systems available on the marketplace.

Communicate easily

- In line with IEC/EN 62040-3, the double conversion UPS meets all the requirements for category VFI-SS-111.
- For connecting the UPS to the network with the option of linking additional sensors and I/O options, either directly on the card or via a sensor manager. HTTP, SNMP, SMTP, Modbus RS232 and Modbus TCP protocols are supported.



Power Distribution Rack

Targeted power distribution in the data centre



Power distribution module in the 482.6 mm (19") format

- Power distribution between the UPS and rack PDU or PSM in a compact 482.6 mm (19") form factor for installation within the IT rack
- Ideal for small data centres and individual rack installations
- Four fused 3-phase outlets to the rack
- Independent fusing of each phase and each output
- Built-in master switch
- All outputs plug-type
- Optional RC circuit-breaker

Power distribution for the rack suite

- Compact PDR for installation within the rack suite with a width of just 300 mm
- Seamless integration into a rack suite with VX IT rack
- Additional equipment may optionally be connected whilst operational
- Optional current measurement system
- Prepared for project-specific design
- Ideal for applications in the IT container

Flexible power distribution

- Installation as either a room or rack solution
- Project-specific selection of peripheral conditions such as rack type and form, ACB type and options ensures flexibility
- Compact design



Power Distribution Unit

Demand-based power distribution in the IT rack



The convincing benefits

- The compact design and tool-free clip fastening onto the 482.6 mm (19") frame in Rittal IT racks allows simple installation in the zero-U-space, guaranteeing free access to the 482.6 mm (19") level – a major advantage when retrofitting IT equipment with the system operational.
- The PDU has every application covered with just five variants
 - Basic (simple power distribution)
 - Metered (measurement per phase)
 - Metered Plus (measurement per output slot)
 - Switched (measurement per phase, switching function per output)
 - Managed (measurement and switching per output)
- The fully redundant Gigabit network interface for connection to management systems such as RiZone allows cascading of up to 16 PDUs.

Technical perfection

- Key monitoring functions (alarm relay, digital input and alarm signal generator) are pre-integrated into the PDU, and up to 8 sensors are supported.
- Extended measuring functions such as fault current monitoring (RCM type B) are available.
- The modular concept means that the PDU controller board and overvoltage protection are replaceable.
- The reliable bistable relays allow up to 300 A starting current on all switchable PDUs.
- Optional integrated surge protection with arresters, which can be replaced with the system operational.

Configure your individual solution online

- The PDU's modular system concept allows individual configuration and optimum adaptation to your specific application. For example, you choose the colour of the housing, the length of the cable, the connector plug or the position of the display yourself.
- Rittal can provide further configuration options, e.g. changing the output slots, adding features such as fault current monitoring and overvoltage protection. Please call us to discuss your individual configuration.



Power Distribution Unit



Overview Page 737 Network/server racks VX IT Page 686

Benefits:

- With the compact PDU, any IT rack is easily equipped with a professional power distribution system
- With the VX IT rack, assembly is tool-free
- Compact design
- Easy to install, even in the zero-U-space
- Power-saving design with minimal inherent consumption by the PDU itself, thanks to the use of bistable relays and durable TFT colour display with power-saving function
- Integral Web server for direct network connection with extensive user administration functions

- Redundant power supply from all 3 phases and additionally via an existing PoE (Power over Ethernet) network
- Extensive range of management and monitoring functions
- High-MTBF and measurement accuracy of $\pm 1\%$
- Redundant network interface, may also be used for cascading up to 16 PDUs (not with PDU basic)
- Electric handle systems and ambient monitoring with up to 8 CMC III sensors (temperature, humidity, access, vandalism)
- 2 x Gigabit Ethernet interfaces for fully redundant network connection
- PDU controller may be replaced without having to disconnect the PDU from the power supply

PDU design variants:

PDU basic

Robust, compact basic power distributor for the IT environment

PDU metered

Energy measurement per phase, i.e. output requirement of an entire IT rack

PDU metered plus

Energy measurement per output connector, to determine the power requirements of individual consumers

PDU switched

Measurement function per phase and individually switchable output slots

PDU managed

High-end IT rack, power distribution with energy measurement and monitoring functions for each individual output slot

Material:

- Extruded aluminium section, anodised

Protection category IP to IEC 60 529:

- IP 20

Supply includes:

- Connector lock for IEC C14 and C20 connectors
- Assembly parts

Standards:

- EN 62 368-1
- EN 61 000-4
- EN 61 000-6
- EN 55 022

Assembly instructions:

- For mounting in the TE 8000 rack, mounting adaptor 7000.688 is additionally required

Low Voltage Directive:

- 2014/35/EU

EMC directive:

- 2014/30/EU

Power Distribution Unit

PDU, basic version

Power			Slots/slot type				Function		Dimensions	PDU installed in rack/ min. rack height mm		Model No.
No. of phases	Phase current A	Output kW	Input	Outputs IEC C13	Outputs IEC C19	Outputs Earthing-pin	Measuring	Switching	PDU length mm	VX IT rack frame	VX IT (zero U) 482.6 mm (19") mounting angles	
1~	16	3.7	IEC C20	8	–	–	–	–	450 (19"/1 U)	800	800	7979.102
1~	16	3.7	CEE	–	–	8	–	–	450 (19"/1 U)	800	800	7979.103
1~	32	7.4	CEE	4	2	–	–	–	450 (19"/1 U)	800	800	7979.104
1~	16	3.7	CEE	12	1	–	–	–	695	1200	1200	7979.110
1~	16	3.7	CEE	–	–	10	–	–	695	1200	1200	7979.111
1~	32	7.4	CEE	16	2	–	–	–	845	1200	1200	7979.112
1~	32	7.4	CEE	12	4	–	–	–	845	1200	1200	7979.113
1~	32	7.4	CEE	–	–	16	–	–	1095	1200	1800	7979.114
1~	16	3.7	CEE	24	4	–	–	–	1095	1200	1800	7979.115
1~	32	7.4	CEE	24	4	–	–	–	1295	1800	1800	7979.116
3~	16	11	CEE	–	9	–	–	–	695	1200	1200	7979.130
3~	32	22	CEE	–	12	–	–	–	1095	1200	1800	7979.131
3~	16	11	CEE	6	6	–	–	–	695	1200	1200	7979.132
3~	16	11	CEE	–	–	18	–	–	1095	1200	1800	7979.133
3~	32	22	CEE	–	–	24	–	–	1695	1800	2000	7979.134
3~	16	11	CEE	18	3	–	–	–	845	1200	1200	7979.135
3~	16	11	CEE	24	6	–	–	–	1095	1200	1800	7979.136
3~	32	22	CEE	24	6	–	–	–	1495	1800	1800	7979.137
3~	16	11	CEE	18	12	–	–	–	1295	1800	1800	7979.138
3~	32	22	CEE	12	12	–	–	–	1495	1800	1800	7979.139
3~	16	11	CEE	36	6	–	–	–	1495	1800	1800	7979.140
3~	32	22	CEE	36	6	–	–	–	1895	2000	2200	7979.141
3~	16	11	CEE	42	–	–	–	–	1495	1800	1800	7979.142
3~	32	22	CEE	48	–	–	–	–	1895	2000	2200	7979.143

PDU, metered version

Power			Slots/slot type				Function		Dimensions	PDU installed in rack/ min. rack height mm		Model No.
No. of phases	Phase current A	Output kW	Input	Outputs IEC C13	Outputs IEC C19	Outputs Earthing-pin	Measuring	Switching	PDU length mm	VX IT rack frame	VX IT (zero U) 482.6 mm (19") mounting angles	
1~	16	3.7	IEC C20	6	–	–	per phase	–	450 (19"/1 U)	800	800	7979.202
1~	16	3.7	CEE	–	–	4	per phase	–	450 (19"/1 U)	800	800	7979.203
1~	32	7.4	CEE	4	2	–	per phase	–	450 (19"/1 U)	800	800	7979.204
1~	16	3.7	CEE	12	1	–	per phase	–	845	1200	1200	7979.210
1~	16	3.7	CEE	–	–	10	per phase	–	1095	1200	1800	7979.211
1~	32	7.4	CEE	16	2	–	per phase	–	1095	1200	1800	7979.212
1~	32	7.4	CEE	12	4	–	per phase	–	1095	1200	1800	7979.213
1~	32	7.4	CEE	–	–	16	per phase	–	1295	1800	1800	7979.214
1~	16	3.7	CEE	24	4	–	per phase	–	1295	1800	1800	7979.215
1~	32	7.4	CEE	24	4	–	per phase	–	1495	1800	1800	7979.216
3~	16	11	CEE	–	9	–	per phase	–	845	1200	1200	7979.230
3~	32	22	CEE	–	12	–	per phase	–	1495	1800	1800	7979.231
3~	16	11	CEE	6	6	–	per phase	–	1095	1200	1800	7979.232
3~	16	11	CEE	–	–	18	per phase	–	1495	1800	1800	7979.233
3~	32	22	CEE	–	–	24	per phase	–	1895	2000	2200	7979.234
3~	16	11	CEE	18	3	–	per phase	–	1095	1200	1800	7979.235
3~	16	11	CEE	24	6	–	per phase	–	1495	1800	1800	7979.236
3~	32	22	CEE	24	6	–	per phase	–	1740	2000	2000	7979.237
3~	16	11	CEE	18	12	–	per phase	–	1695	1800	2000	7979.238
3~	32	22	CEE	12	12	–	per phase	–	1695	1800	2000	7979.239
3~	16	11	CEE	36	6	–	per phase	–	1895	2000	2200	7979.240
3~	16	11	CEE	42	–	–	per phase	–	1695	1800	2000	7979.242

Power Distribution Unit

PDU, metered plus version

Power			Slots/slot type				Function		Dimensions	PDU installed in rack/ min. rack height mm		Model No.
No. of phases	Phase current A	Output kW	Input	Outputs IEC C13	Outputs IEC C19	Outputs Earthing-pin	Measuring	Switching	PDU length mm	VX IT rack frame	VX IT (zero U) 482.6 mm (19") mounting angles	
1~	16	3.7	IEC C20	6	–	–	per output	–	450 (19"/1 U)	800	800	7979.502
1~	16	3.7	CEE	–	–	4	per output	–	450 (19"/1 U)	800	800	7979.503
1~	32	7.4	CEE	4	2	–	per output	–	450 (19"/1 U)	800	800	7979.504
1~	16	3.7	CEE	12	1	–	per output	–	845	1200	1200	7979.510
1~	16	3.7	CEE	–	–	10	per output	–	1095	1200	1800	7979.511
1~	32	7.4	CEE	16	2	–	per output	–	1095	1200	1800	7979.512
1~	32	7.4	CEE	12	4	–	per output	–	1095	1200	1800	7979.513
1~	32	7.4	CEE	–	–	16	per output	–	1495	1800	1800	7979.514
1~	16	3.7	CEE	24	4	–	per output	–	1295	1800	1800	7979.515
1~	32	7.4	CEE	24	4	–	per output	–	1495	1800	1800	7979.516
3~	16	11	CEE	–	9	–	per output	–	845	1200	1200	7979.530
3~	32	22	CEE	–	12	–	per output	–	1495	1800	1800	7979.531
3~	16	11	CEE	6	6	–	per output	–	1095	1200	1200	7979.532
3~	16	11	CEE	–	–	18	per output	–	1495	1800	1800	7979.533
3~	32	22	CEE	–	–	24	per output	–	2095	2200	2200	7979.534
3~	16	11	CEE	18	3	–	per output	–	1095	1200	1800	7979.535
3~	16	11	CEE	24	6	–	per output	–	1495	1800	1800	7979.536
3~	32	22	CEE	24	6	–	per output	–	1740	2000	2000	7979.537
3~	16	11	CEE	18	12	–	per output	–	1695	1800	2000	7979.538
3~	32	22	CEE	12	12	–	per output	–	1695	1800	2000	7979.539
3~	16	11	CEE	36	6	–	per output	–	1895	2000	2200	7979.540
3~	16	11	CEE	42	–	–	per output	–	1695	1800	2000	7979.542

PDU, switched version

Power			Slots/slot type				Function		Dimensions	PDU installed in rack/ min. rack height mm		Model No.
No. of phases	Phase current A	Output kW	Input	Outputs IEC C13	Outputs IEC C19	Outputs Earthing-pin	Measuring	Switching	PDU length mm	VX IT rack frame	VX IT (zero U) 482.6 mm (19") mounting angles	
1~	16	3.7	IEC C20	6	–	–	per phase	■	450 (19"/1 U)	800	800	7979.302
1~	16	3.7	CEE	–	–	4	per phase	■	450 (19"/1 U)	800	800	7979.303
1~	32	7.4	CEE	4	2	–	per phase	■	450 (19"/1 U)	800	800	7979.304
1~	16	3.7	CEE	12	1	–	per phase	■	845	1200	1200	7979.310
1~	16	3.7	CEE	–	–	10	per phase	■	1095	1200	1800	7979.311
1~	32	7.4	CEE	16	2	–	per phase	■	1095	1200	1800	7979.312
1~	32	7.4	CEE	12	4	–	per phase	■	1095	1200	1800	7979.313
1~	32	7.4	CEE	–	–	16	per phase	■	1495	1800	1800	7979.314
1~	16	3.7	CEE	24	4	–	per phase	■	1295	1800	1800	7979.315
1~	32	7.4	CEE	24	4	–	per phase	■	1495	1800	1800	7979.316
3~	16	11	CEE	–	9	–	per phase	■	845	1200	1200	7979.330
3~	32	22	CEE	–	12	–	per phase	■	1495	1800	1800	7979.331
3~	16	11	CEE	6	6	–	per phase	■	1095	1200	1200	7979.332
3~	16	11	CEE	–	–	18	per phase	■	1495	1800	1800	7979.333
3~	32	22	CEE	–	–	24	per phase	■	2095	2200	2200	7979.334
3~	16	11	CEE	18	3	–	per phase	■	1095	1200	1800	7979.335
3~	16	11	CEE	24	6	–	per phase	■	1495	1800	1800	7979.336
3~	32	22	CEE	24	6	–	per phase	■	1740	2000	2000	7979.337
3~	16	11	CEE	18	12	–	per phase	■	1695	1800	2000	7979.338
3~	32	22	CEE	12	12	–	per phase	■	1695	1800	2000	7979.339
3~	16	11	CEE	36	6	–	per phase	■	1895	2000	2200	7979.340
3~	16	11	CEE	42	–	–	per phase	■	1695	1800	2000	7979.342

Power Distribution Unit

PDU, managed version

Power			Slots/slot type				Function		Dimensions	PDU installed in rack/ min. rack height mm		Model No.
No. of phases	Phase current A	Output kW	Input	Outputs IEC C13	Outputs IEC C19	Outputs Earthing-pin	Measuring	Switching	PDU length mm	VX IT rack frame	VX IT (zero U) 482.6 mm (19") mounting angles	
1~	16	3.7	IEC C20	6	–	–	per output	■	450 (19"/1 U)	800	800	7979.402
1~	16	3.7	CEE	–	–	4	per output	■	450 (19"/1 U)	800	800	7979.403
1~	32	7.4	CEE	4	2	–	per output	■	450 (19"/1 U)	800	800	7979.404
1~	16	3.7	CEE	12	1	–	per output	■	845	1200	1200	7979.410
1~	16	3.7	CEE	–	–	10	per output	■	1095	1200	1800	7979.411
1~	32	7.4	CEE	16	2	–	per output	■	1095	1200	1800	7979.412
1~	32	7.4	CEE	12	4	–	per output	■	1095	1200	1800	7979.413
1~	32	7.4	CEE	–	–	16	per output	■	1495	1800	1800	7979.414
1~	16	3.7	CEE	24	4	–	per output	■	1295	1800	1800	7979.415
1~	32	7.4	CEE	24	4	–	per output	■	1495	1800	1800	7979.416
3~	16	11	CEE	–	9	–	per output	■	845	1200	1200	7979.430
3~	32	22	CEE	–	12	–	per output	■	1495	1800	1800	7979.431
3~	16	11	CEE	6	6	–	per output	■	1095	1200	1200	7979.432
3~	16	11	CEE	–	–	18	per output	■	1495	1800	1800	7979.433
3~	32	22	CEE	–	–	24	per output	■	2095	2200	2200	7979.434
3~	16	11	CEE	18	3	–	per output	■	1095	1200	1800	7979.435
3~	16	11	CEE	24	6	–	per output	■	1495	1800	1800	7979.436
3~	32	22	CEE	24	6	–	per output	■	1740	2000	2000	7979.437
3~	16	11	CEE	18	12	–	per output	■	1695	1800	2000	7979.438
3~	32	22	CEE	12	12	–	per output	■	1695	1800	2000	7979.439
3~	16	11	CEE	36	6	–	per output	■	1895	2000	2200	7979.440
3~	16	11	CEE	42	–	–	per output	■	1695	1800	2000	7979.442

PDU UK, basic version

Power			Slots/slot type			Function		Dimensions	PDU installed in rack/ min. rack height mm		Model No.
No. of phases	Phase current A	Output kW	Input	Outputs BS1363	Outputs IEC C19	Measuring	Switching	PDU length mm	VX IT rack frame	VX IT 482.6 mm (19") mounting angles	
1~	13	3.0	BS1363	6	–	–	–	450 (19"/1 U)	800	800	7979.801
1~	13	3.0	BS1363	8	–	–	–	695	800	800	7979.811
1~	13	3.0	BS1363	12	–	–	–	845	1200	1200	7979.812
1~	13	3.0	BS1363	16	–	–	–	1095	1200	1800	7979.813
1~	16	3.7	CEE	16	4	–	–	1295	1800	1800	7979.814
1~	32	7.4	CEE	16	4	–	–	1495	1800	1800	7979.815

PDU UK, metered version

Power			Slots/slot type			Function		Dimensions	PDU installed in rack/ min. rack height mm		Model No.
No. of phases	Phase current A	Output kW	Input	Outputs BS1363	Outputs IEC C19	Measuring	Switching	PDU length mm	VX IT rack frame	VX IT 482.6 mm (19") mounting angles	
1~	13	3.0	BS1363	16	–	per phase	–	1495	1800	1800	7979.821
1~	16	3.7	CEE	16	4	per phase	–	1695	1800	2000	7979.822
1~	32	7.4	CEE	16	4	per phase	–	1695	1800	2000	7979.823

Power Distribution Unit

Overvoltage protection modules, with replaceable arresters and alarm contact

Overvoltage protection module type 3	Type of connection	Connection cable/length	Phases	Phase current A	Output kW	Packs of	Model No.	Page
Design	CEE connector/coupling	H05VV-F3G2.5, 1 m	1~	16	3.7	1 pc(s).	7979.721	754
Design	CEE connector/coupling	H05VV-F3G4.0, 1 m	1~	32	7.4	1 pc(s).	7979.722	754
Design	CEE connector/coupling	H05VV-F5G2.5, 1 m	3~	16	11.0	1 pc(s).	7979.723	754
Design	CEE connector/coupling	H05VV-F5G4.0, 1 m	3~	32	22.0	1 pc(s).	7979.724	754

PDU accessories

	Packs of	Model No.	Page
Slot cover for C13 jack, lockable	10 pc(s).	7955.010	752
Slot cover for C19 jack, lockable	10 pc(s).	7955.015	752
Connector lock for C14/C20 connector	20 pc(s).	7979.020	752
PDU mounting adaptor for TE 7000/TE 8000	2 pc(s).	7000.688	752
PDU accessory pack	1 pc(s).	7979.001	

CMC III/PDU sensors

CMC III/PDU sensor type	Packs of	Model No.	Page
Temperature sensor	1 pc(s).	7030.110	807
Temperature/humidity sensor (combi-sensor)	1 pc(s).	7030.111	807
Infrared access sensor	1 pc(s).	7030.120	807
Vandalism sensor	1 pc(s).	7030.130	807
Analogue airflow sensor	1 pc(s).	7030.140	807
Analogue differential pressure sensor	1 pc(s).	7030.150	807
Universal sensor (digital inputs)	1 pc(s).	7030.190	807
Smoke detector	1 pc(s).	7030.400	807
Leak sensor	1 pc(s).	7030.430	807
Leak sensor, 15 m	1 pc(s).	7030.440	807
CMC III CAN bus connection cable RJ 45 (length: 0.5 m, 1x required for each sensor)	1 pc(s).	7030.090¹⁾	818
CMC III CAN bus connection cable RJ 45 (length: 1.0 m, 1x required for each sensor)	1 pc(s).	7030.091¹⁾	818
CMC III CAN bus connection cable RJ 45 (length: 1.5 m, 1x required for each sensor)	1 pc(s).	7030.092¹⁾	818
CMC III CAN bus connection cable RJ 45 (length: 2.0 m, 1x required for each sensor)	1 pc(s).	7030.093¹⁾	818

¹⁾ Other cable lengths may be found under CMC III accessories on page 818

VX IT handle system

VX IT handle system (2 handles may be connected per PDU)	Packs of	Model No.	Page
CMC III online comfort handle VX	1 pc(s).	7030.611	814
Coded lock for CMC III	1 pc(s).	7030.223	813
Transponder reader for CMC III	1 pc(s).	7030.233	813
CMC III Access Control (1x required for each handle system)	1 pc(s).	7030.202	812

Power Distribution Unit

Overview

PDU version ¹⁾	managed	switched	metered plus	metered	basic
Mechanical	managed	switched	metered plus	metered	basic
Compact extruded aluminium section, black anodised (other enclosure colours optionally available), W x D: 1 U x 70 mm, various lengths depending on number of slots	■	■	■	■	■
May be fitted in the the zero-U-space in the 600 mm wide Rittal IT rack, (2 PDUs per side, up to 4 in 800 mm wide Rittal IT racks)	■	■	■	■	■
Special PDU versions available for 482.6 mm (19") mounting	■	■	■	■	■
Colour coding of phases and fuse circuits (L1 = pink, L2 = black, L3 = white)	■	■	■	■	■
Universal mounting kit and assembly parts included with the supply	■	■	■	■	■
Tool-free installation kit especially for Rittal VX IT rack included with the supply	■	■	■	■	■
Display/controller unit in the PDU enclosure rotatable through 180° and replaceable	■	■	■	■	–
Connection cable, static, 3 m, with CEE (IEC 60 309) or IEC C20 input connector (customised modification available)	■	■	■	■	■
Compact circuit-breaker, 16 A, Carling type (only for 32 A PDU versions)	■	■	■	■	■
Output slots IEC 60 320 C13 available	■	■	■	■	■
Output slots IEC 60 320 C19 available	■	■	■	■	■
Output slots CEE 7/3 (earthing-pin socket) available	■	■	■	■	■
Output slots BS 1363 (UK plug) available	–	–	–	■	■
Connector lock for C13 and C19 sockets (optionally as accessories)	■	■	■	■	■
Lockable cover for unneeded C13/C19 slots (optional accessory)	■	■	■	■	■
Electrical	managed	switched	metered plus	metered	basic
Rated operating voltage 230 V (400 V, 3–), 50 – 60 Hz	■	■	■	■	■
PDUs for rated current 16 A/32 A, single-phase/3-phase	■	■	■	■	■
Integral, fully-redundant power pack, power supply from all phases	■	■	■	■	–
Power-saving design, minimal intrinsic power consumption	■	■	■	■	–
PDU with own power supply, no external power supply required	■	■	■	■	–
Error-tolerant PDU power supply redundant across all phases (with 3-phase PDUs)	■	■	■	■	–
Emergency power supply to PDU web server via PoE (Power over Ethernet) and sequential relay circuit (PoE+ to IEEE 802.3at), remains accessible even in the event of a mains failure	■	■	–	–	–
Optional: Type 3 overvoltage protection with interchangeable arresters while operational, with status monitoring, suitable for integration into PDU enclosure	■	■	■	■	■
Switching function per output slot	■	■	–	–	–
Sequential activation of the outputs once the power is resumed (avoids overload peaks)	■	■	–	–	–
Relay states are saved even in the event of a power failure	■	■	–	–	–
Bistable relays/low current consumption/high switching capacity also for higher starting currents (max. 300 A)	■	■	–	–	–
Grouping (joint switching of several outputs)	■	■	–	–	–
Programmable startup response following voltage recovery (on/off/last status)	■	■	–	–	–
Programmable startup response (time and programmable logic)	■	■	–	–	–
Measurement functions	managed	switched	metered plus	metered	basic
Voltage (V), current (A), frequency (Hz)	■	■	■	■	–
Active power (kW), active energy (kWh), apparent power (VA), apparent energy (kVA)	■	■	■	■	–
Power factor (cosPhi) and phase angle	■	■	■	■	–
Neutral conductor measurement to identify unbalanced loads (3-phase PDUs only)	■	■	■	■	–
Optional: Differential current measurement (type B) per infeed/phase/fuse	■	■	■	■	–
Fuse monitoring for PDUs with integral fuse (32 A PDUs)	■	■	■	■	–
Monitoring of the optionally available overvoltage protection	■	■	■	■	–
Alarm contact for optional overvoltage protection on terminals	–	–	–	–	■
Measurement per phase or infeed	■	■	■	■	–
Measurement per output slot	■	–	■	–	–
Measurement accuracy ±1% to IEC/EN 62 053-21	■	■	■	■	–

¹⁾ In addition to the defined products, customised modifications are also possible.

Note:

- Select plausibility-checked enclosures and components easily with the Rittal Configuration System, plan machining and place your order, see page 272

Power Distribution Unit

Overview

PDU version ¹⁾	managed	switched	metered plus	metered	basic
Connectivity/management functions	managed	switched	metered plus	metered	basic
Powerful CPU (ARM Cortex A8)	■	■	■	■	–
Integral real-time clock with battery buffering (max. 10 years, battery replaceable)	■	■	■	■	–
Integral piezo beeper	■	■	■	■	–
Digital input (floating contact)	■	■	■	■	–
Additional alarm output/relay output (changeover contact)	■	■	■	■	–
Bright TFT display, 128 x 128 pixels (RGB) with back-lighting and energy-saving mode (display of output data and basic PDU configuration)	■	■	■	■	–
Position sensors for display rotation and correct PDU representation on the website	■	■	■	■	–
Multi-colour LEDs (green/amber/red) to indicate switching states and warning/alarm limits per phase or infeed	■	■	■	–	–
Multi-colour LEDs (green/amber/red) to indicate switching states and limits per individual output slot	■	–	■	–	–
Power LED, indicates presence of voltage	■	■	■	■	–
Adjustable limit values (warning/alarm) for voltage, current, output	–	■	–	■	–
Adjustable limit values (warning/alarm) for current, voltage, output, individually setting for each output slot	■	–	■	–	–
Operating hours meter, total and cyclical (resettable)	■	■	■	■	–
Fully redundant Ethernet interface 10/100/1000 Mbit/s (2 x RJ45)	■	■	■	■	–
USB 2.0 port (USB-A) for mass configuration, firmware update and data logging	■	■	■	■	–
CAN bus interface (RJ 45) for a maximum of 8 ambient sensors	■	■	■	■	–
Serial interface RS232 (RJ12) for CMC III LTE unit, scripting, CLI	■	■	■	■	–
Web server (HTTP, HTTPS, SSL, SSH) Telnet, NTP	■	■	■	■	–
TCP/IP v4 and v6, DHCP, DNS	■	■	■	■	–
SNMP v1, v2c and v3, Modbus/TCP, OPC-UA	■	■	■	■	–
MIB for linking into 3rd party DCIM software	■	■	■	■	–
FTP/SFTP (update/file transfer)	■	■	■	■	–
Rest API	■	■	■	■	–
Use of own certificates/TLS 1.3	■	■	■	■	–
E-mail forwarding in case of alarm (SMTP)	■	■	■	■	–
User administration including rights management	■	■	■	■	–
LDAP(S)/Radius/Active Directory connection	■	■	■	■	–
Syslog server connection (max. 2 servers)	■	■	■	■	–
Fully redundant monitoring via 2nd network	■	■	■	■	–
CMC III CAN bus sensors may be connected for ambient monitoring (max. 8 sensors)	■	■	■	■	–
CMC III sensors: Temperature, humidity, smoke detector, VX IT handle systems, infrared access sensor, vandalism sensor, airflow, differential pressure, etc.	■	■	■	■	–
Ambient conditions	managed	switched	metered plus	metered	basic
Operating temperature	+5...+50 °C @100% load				
Storage temperature	-25 °C...+70 °C				
Ambient humidity (non-condensing)	10 – 95% rel. humidity				
Protection category (IEC 60 529)	IP 20				
Approvals and standards	managed	switched	metered plus	metered	basic
Approvals and standards	CE/EAC/RoHS/WEEE				
Low Voltage Directive	2014/35/EU				
EMC Directive	2014/30/EU				
Standards (excerpt)	EN 62 368-1/EN 62 053-21/EN 61 000-3/EN 61 000-4/ EN 61 000-6				

¹⁾ In addition to the defined products, customised modifications are also possible.

Sample application

PDU cascading

Cascading of up to 16 PDUs in series is supported via the network interface.

Master/slave operating mode

Each PDU may also be used individually as a master or slave PDU. The master PDU controls up to three slave PDUs.

Connection of CAN bus sensors

Up to 8 CMC III CAN bus sensors may be connected to one PDU for ambient monitoring (temperature, humidity, access, vandalism).

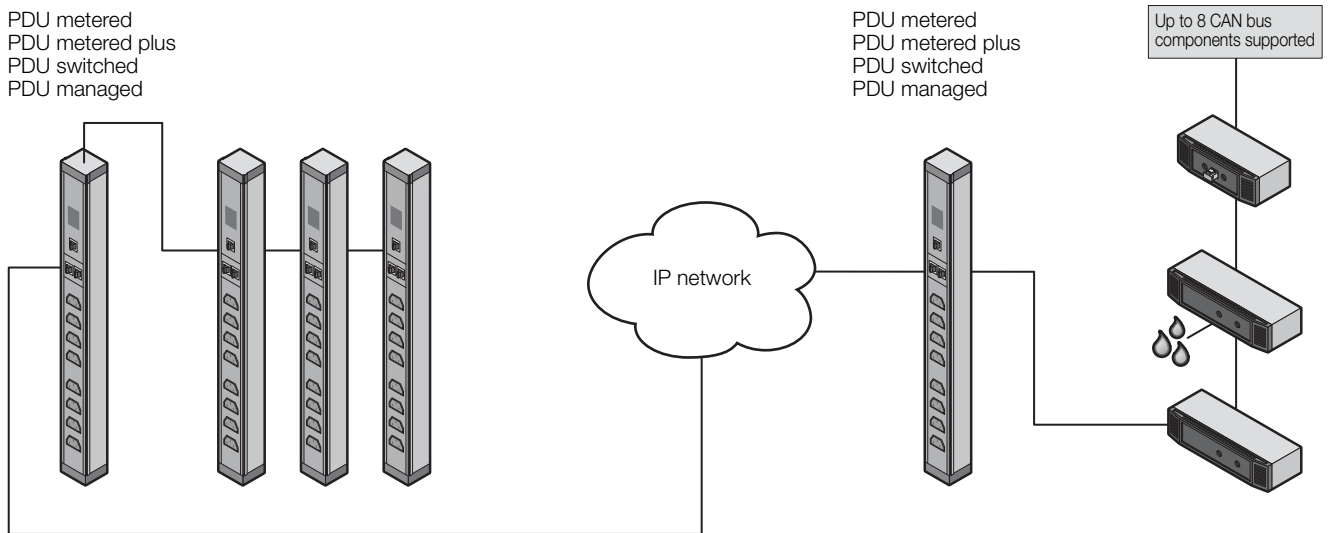

Technical specifications

Equipment		
Standards	Safety	EN 62 368-1
	EMC	EN 55 022/B, EN 61 000-4-2, EN 61 000-4-3, EN 61 000-6-2, EN 61 000-6-3
Low Voltage Directive		2014/35/EU
EMC Directive		2014/30/EU
MTBF (at 40 °C)		100,000 hours
Protection category		IP 20 (IEC 60 529)
Protection class		1
Contamination level		2
Overvoltage category		II
Environmental properties		RoHS 2 (2011/65/EU)
Storage temperature		-20 °C...+70 °C
Ambient temperatures		+5 °C...+50 °C
Ambient humidity (non-condensing)		10 – 95% rel. humidity
Connector lock C14/C20		1 x (optional additional locks 7979.020)
Covers C13		Optional 7955.010
Covers C19		Optional 7955.015

Power Distribution Unit

Technical specifications

Compact power distributor for use in IT server and network racks. Please observe the relevant product dimensions and check whether the PDU can be installed in your preferred rack. The PDU dimensions and the minimum rack height required may be found in the ordering table from page 733. The technical specifications listed below apply wholly or partially to the following PDU products:

- PDU metered (power measurement at the infeed or per phase. Without switching function)
- PDU metered plus (power measurement per individual outgoing slot. Without switching function)
- PDU switched (power measurement at the infeed or per phase. With switching function)
- PDU managed (power measurement per individual outgoing slot. With switching function)

Technical specifications apply to the following product variants:

PDU metered 7979.2XX, PDU metered plus 7979.5XX, PDU switched 7979.3XX, PDU managed 7979.4XX

Equipment		
Input voltage range (L – N)	230 V (400 V, 3~), 50 – 60 Hz	
Input current	16 A/32 A (depending on product variant)	
No. of phases	1 or 3 depending on product variant	
PDU inherent supply	Integral long-range SMPS, error-tolerant from all phases	
PDU power consumption	approx. 10 W	
Redundant power supply via PoE	Yes (with PDU switched, PDU managed)	
Marking of phases (3-phase PDUs only: L1, L2, L3)	Rittal Power Pink, black, white	
Slots type EN 60 320/C13	Quantity depends on version	
Slots type EN 60 320/C19	Quantity depends on version	
No. of circuit-breakers	2 (single-phase) or 6 (3-phase) with 32 A version	
Hydraulic-magnetic protective circuit-breaker	16 A (Carling)	
Slots individually switchable	Yes, only for PDU switched, PDU managed (bistable relay, minimal inherent consumption)	
Connector, PDU input	EN 60 309/CEE or EN 60 320-C20 (depending on product variant)	
Length of connection cable	3 m	
Connection cable type	H05-VV	
No. of wires	3/5 (single-phase/3-phase PDU)	
Cable cross-section	2.5 mm ² /4.0 mm ² (for 16 A/32 A versions)	
PDU enclosure width	44 mm (1 U)	
PDU enclosure depth	70 mm	
PDU enclosure height (length)	Depends on product variant	
PDU material	Aluminium, anodised in RAL 9005 (black, other colours may be configured)	
PDU mounting adaptor	Plastic, black	
PDU mounting options	On the enclosure frame, at the side of the 482.6 mm (19") mounting frame (zero-U space) as well as on the cable route (push-button attachment)	
Measurement functions (input/phase or output slot)	Values recorded (standard configuration)	Voltage (V), phase current (A), frequency (Hz), active power (kW), active energy (kWh), apparent power (VA), apparent energy, reactive power, power factor, neutral-conductor measurement / load imbalance detection, crest factor, THDU/THDI, fuse monitoring (with 32 A versions) and operating hours meter
	Acquired values (individually configurable)	Differential current measurement (RCM type B), measurement range: 0 - 100 mA AC, max. 6 measuring points per PDU supported, input per phase/per fuse
	Overvoltage protection (type 3, replaceable with the system operational)	Electronic monitoring with PDU metered, metered plus, switched, managed, with PDU basic via floating alarm contact
	Voltage measurement range	90 V – 260 V
	Voltage resolution	0.1 V
	Current measurement range	0 – 16/32 A (depending on product variant)
	Current resolution	0.1 A
	Measurement accuracy	Typ. 1%
Freely settable limit values for warning/ alarm	Yes	
Operating hours meter	Yes	
Display	TFT colour display, RGB 128 x 128 pixels, LED per slot (for PDU switched, PDU managed)	
Network interface	2 x RJ45, 10/100/1000 Mbit/s	
Supported protocols	TCP/IP v4 and v6, HTTP, HTTPS, SSL, SSH, NTP, Telnet, DHCP, DNS, NTP, Syslog, SNMP v1, v2c and v3, XML, FTP/SFTP (update/file transfer), e-mail forwarding (SMTP), OPC-UA server, Modbus/TCP	
User administration including rights management	Yes	
LDAP(S)/Radius/Active Directory connection	Yes	
Interfaces		
USB port for firmware update, data logging function, mass configuration	Yes	
Serial interface	RS232 (RJ12) for LTE unit, scripting, CLI	
Digital input	Floating contact	
Alarm (acoustic)	Piezo beeper	
CAN bus interface	RJ45, for connecting sensors	
CAN sensor types	Temperature, temperature/humidity (combined), infrared access sensor, vandalism sensor, handle systems (except wireless) and automatic door opening	
Max. number of sensors per PDU	8 sensor configuration freely selectable	
Plug & play drivers in the Rittal RiZone DCIM software	Yes	
Conformity	CE, EAC	

We reserve the right to make technical modifications

Power Distribution Unit

Ambient monitoring with up to 8 CMC III sensors,
see page 730



Modular Power Distribution Unit

Flexible power distribution in IT racks



Maximum efficiency

- A modern PDU (PSM) allows you to respond flexibly at any time to changing requirements for the IT power supply in the server rack, even years later. You can change the slot configuration of the modular PDU (PSM) at any time, and even add completely new functions, without having to interrupt the power supply to the IT rack.
- The vertical, contactless busbar as the basic equipment for any IT rack permits a high degree of flexibility with versatile, plug-in modules with different socket types that may be exchanged while the system is operational.
- Patented plug & play system for exchanging modules while operational. In redundant systems, the circuit is changed by simply rotating the module.

Monitor, control and switch

- Power measurement and switching functions for the output slots can be added to any busbar with these plug-in modules. The modules are also suitable for upgrading existing installations if it becomes necessary to record the power data or add a switching option for the connected equipment.
- The outgoing slots may be switched individually and in groups, with the status for each slot indicated by an LED.
- Voltage, current and active power limits may be configured to suit your requirements. This supports the implementation of ISO 50001 and EN 600-2-2.

Impressive functions

- Extensive power measurement and switching functions for each output slot, both individually and in groups
- Easily integrated into the CMC III monitoring system
- Single-phase or 3-phase infeed, up to 22 kW per PSM busbar
- All standard protocols supported in conjunction with CMC III



Modular PDU (PSM)

Modular busbars



PSM busbars and PSM socket modules

PSM busbars

The modular system facilitates basic configuration of the racks, thanks to a vertical support rail with single-/3-phase infeed. The various socket modules to supply the active components may be snap-fitted into the support rail. This can even be done whilst the system is operational, because the support section is shock hazard-protected.

PSM socket modules

The various modules, earthing pins, IEC 60 320 etc. may be inserted into the support rail in any combination. This is easily achieved, even by non-electricians, thanks to the shock hazard protected plug & play system.

Approvals:

Available on the Internet

Technical specifications/benefits:

- Each socket module picks off a phase on the support rail, either from infeed **A** or from the redundant infeed **B**, depending on the direction of connection
- Single-/3-phase construction with a maximum current of 2 x (3 x 16 A)
- 3-phase redundant infeed supported
- The redundant circuit is completely separate from the 3 phases of the support rail
- Modules may be retrofitted whilst operational
- Modules may be equipped with integral overcurrent protection, so that only the affected module is deactivated in the event of an excessively high current; the other modules remain operational
- Overvoltage protection may be integrated into the supply line
- Various modules also available with current measurement and switchable outputs



Modular PDU (PSM)

Modular busbars

PSM busbar

Equipment	Model No.				
	7856.005	7856.006	7856.008	7856.010	7856.020
Packs of	1 pc(s).	1 pc(s).	1 pc(s).	1 pc(s).	1 pc(s).
Minimum height of rack	2000 mm	2000 mm	2200 mm	1200 mm	2000 mm
Type of connection/length	fixed/3 m	fixed/3 m	WAGO jack	WAGO jack	WAGO jack
Connector	CEE	CEE	X-COM	X-COM	X-COM
No. of infeeds	1	2	2	2	2
No. of phases	3	3	3	3	3
Phase current	16 A	16 A	16 A	16 A	16 A
Various connection cables, also for single-phase connection	-	-	■	■	■
No. of PSM module slots	7	7	8	4	7
Integral energy measurement of voltage, current, active power, apparent power, active energy, power factor, mains frequency	-	-	-	-	-
Measurement accuracy (U, I, f, P, S)	-	-	-	-	-
Measurement accuracy (E/kWh)	-	-	-	-	-
Graphic display for visualising the measurements (24 V DC required)	-	-	-	-	-
CAN bus interface for connecting to CMC III system	-	-	-	-	-
Web server (IPv4, IPv6, SNMP, SSH) via CMC III (PU 7030.000/PU Compact 7030.010)	-	-	-	-	-
E-mail forwarding of exceeded limits and alarms (CMC III required)	-	-	-	-	-
Operating temperature	+5 °C...+45 °C				
Ambient humidity (non-condensing)	10 – 90%				
Protection category IP (to IEC 60 529)	IP 20				
Approvals	CE	CE	CE	CE	CE

Equipment	Model No.			
	7856.321	7856.323	7859.050	7859.053
Packs of	1 pc(s).	1 pc(s).	1 pc(s).	1 pc(s).
Minimum height of rack	2000 mm	2000 mm	2000 mm	2000 mm
Type of connection/length	fixed/3 m	fixed/3 m	WAGO jack	fixed/3 m
Connector	CEE	CEE	X-COM	CEE
No. of infeeds	1	1	2	1
No. of phases	1	3	3	1
Phase current	32 A	32 A	16 A	32 A
Various connection cables, also for single-phase connection	-	-	■	-
No. of PSM module slots	6	6	6	6
Integral energy measurement of voltage, current, active power, apparent power, active energy, power factor, mains frequency	-	-	■	■
Measurement accuracy (U, I, f, P, S)	-	-	2%	2%
Measurement accuracy (E/kWh)	-	-	1%	1%
Graphic display for visualising the measurements (24 V DC required)	-	-	■	■
CAN bus interface for connecting to CMC III system	-	-	■	■
Web server (IPv4, IPv6, SNMP, SSH) via CMC III (PU 7030.000/PU Compact 7030.010)	-	-	■	■
E-mail forwarding of exceeded limits and alarms (CMC III required)	-	-	■	■
Operating temperature	+5 °C...+45 °C			
Ambient humidity (non-condensing)	10 – 90%			
Protection category IP (to IEC 60 529)	IP 20			
Approvals	CE	CE	CE	CE

! Also required:

- PSM socket modules, see page 748

+ Accessories:

- Mounting kit for PSM busbars, see page 751
- Connection cables, see page 751
- Cable lock, see page 752
- Overvoltage protection, see page 751



Modular PDU (PSM)

Modular busbars



PSM zero-U space

Modular PDU for space-saving integration in the zero-U space between side panel and 482.6 mm (19") mounting level in 800 mm wide IT racks.

Equipment	Model No.		
	7859.080	7859.081	7859.090
Packs of	1 pc(s).	1 pc(s).	1 pc(s).
Minimum height of rack	2000 mm	2000 mm	2000 mm
Length	1695 mm	1695 mm	1695 mm
Type of connection/length	WAGO jack	fixed/3 m	fixed/3 m
Connector	X-COM	CEE	CEE
No. of infeeds	2	1	1
No. of phases	3	3	1
Phase current	16 A	16 A	32 A
Various connection cables, also for single-phase connection	■	-	-
No. of PSM module slots	6	6	5
Operating temperature	+5 °C...+45 °C		
Ambient humidity (non-condensing)	10 – 90%		
Protection category IP (to IEC 60 529)	IP 20		
Approvals	CE	CE	CE



Also required:

- PSM socket modules, see page 748
- Mounting kit for PSM busbars 7859.065, see page 751



Accessories:

- Connection cables, see page 751
- Cable lock, see page 752
- Overvoltage protection, see page 751

Modular PDU (PSM)

Modular measurement bars

PSM measurement bar for CMC III

Measurement bars for direct connection to the CMC III system. With a PSM mounting kit, the measurement bar may be vertically mounted in 2000 mm high VX IT racks. Display and monitoring of all major output parameters is supported, separated by phase and infeed. An integral display provides a local on-site display in the rack. Remote administration and network connectivity are created via the CMC III system.

Benefits:

- Modular extendible system
- For 16 A and 32 A phase current
- Various PSM connection modules (pin patterns)
- PSM modules may be connected with the system operational
- Easy to assemble
- CAN bus for connection to CMC III system
- Extensive management and monitoring monitoring functions (via CMC III)
- High-MTBF and measurement accuracy of 1 %
- Energy-efficient electric design – minimal inherent power consumption
- High-quality aluminium housing, for flexible mounting

Measurement functions:

- Voltage (V), current (A), frequency (Hz)
- Active power (kW), active energy (kWh), apparent power (VA), apparent energy (kVAh)
- Power factor (cos phi)
- Zero conductor current measurement/ load imbalance detection
- Measurement per phase or infeed
- Measurement accuracy 1% (kWh) to IEC 62 053-21

Material:

- Extruded aluminium section, anodised

Protection category IP to IEC 60 529:

- IP 20

Standards:

- EN 61 000-6-1
- EN 61 000-6-2
- EN 55 022

Low Voltage Directive:

- 2014/35/EU

EMC directive:

- 2014/30/EU

Approvals:

Available on the Internet

Photo shows a configuration example with equipment not included in the scope of supply



Model No.	7859.050	7859.053	Page
Packs of	1 pc(s).	1 pc(s).	
Version/rated current (per phase)	16 A	32 A	
No. of infeeds (3-phase, 16 A/single-phase, 32 A)	2	1	
Connection cable, plug-in, various configurations	■	-	
Connection cable, fixed, 3 m, with CEE connector, 32 A, single-phase (IEC 60 309)	-	■	
Electromagnetic circuit-breaker (2 x 16 A, type C)	-	■	
Input voltage 230 V/400 V (50/60 Hz)	■	■	
Power supply via CMC III system (24 V DC)	■	■	
CAN bus for direct connection to CMC III system (RJ45, 2x sockets)	■	■	
Maximum no. of systems that may be connected to one CMC III PU	8	8	
Ambient conditions			
Operating temperature	0 °C...+45 °C		
Storage temperature	-25 °C...+70 °C		
Ambient humidity (non-condensing)	10 – 95 %		
Accessories			
PSM connection cable, 3-phase, with CEE connectors (IEC 60 309), length 3 m (2 x required when using both infeeds)	7856.025	Fixed installation	751
PSM mounting kit for mounting on the VX IT rack frame, height 2000 mm	7859.060	7859.060	751
PSM module 4 x earthing-pin, black	7856.100	7856.100	748
PSM module 4 x earthing-pin, red	7856.240	7856.240	748
PSM module 6 x C13	7856.080	7856.080	748
PSM module 4 x C19	7856.230	7856.230	748
Other PSM socket modules	see page 748		

Modular PDU (PSM)

PSM socket modules

PSM socket modules

max. 16 A/3680 W per module



Equipment	Model No.							
	[1]							
	7856.080	7856.082	7856.100	7856.240	7856.230	7856.070	7856.220	7856.090
Packs of	1 pc(s).	1 pc(s).	1 pc(s).	1 pc(s).	1 pc(s).	1 pc(s).	1 pc(s).	1 pc(s).
Occupied slots in PSM busbar	1	1	1	1	1	1	1	1
Connector pattern (type)	IEC 60 320 C13	IEC 60 320 C13	Earthing-pin CEE 7/3	Earthing-pin CEE 7/3	IEC 60 320 C19	IEC 60 320 C13	IEC 60 320 C13	Earthing-pin CEE 7/3
Number of outputs	6	6	4	4	4	6	4	4
Colour of slots	black	red	black	red	black	black	black	black
Lockable connectors (optional)	■	■	-	-	-	-	-	-
Miniature fuse per output	-	-	-	-	-	-	■	-
Thermal overload protection	-	-	-	-	-	■	-	■
Optical LED display (total current)	-	-	-	-	-	-	-	-
Optical LED display (switching status/status)	-	-	-	-	-	-	-	-
Illuminated colour display (display of measurements/alarms)	-	-	-	-	-	-	-	-
Switchable outputs (via CMC III)	-	-	-	-	-	-	-	-
Energy measurement per module (total values)	-	-	-	-	-	-	-	-
Dimensions (W x H x D)	52 x 250 x 45 mm							
Operating temperature	+5 °C...+45 °C							
Ambient humidity (non-condensing)	10 – 95 %							
Material	Extruded aluminium section/plastic							
Approvals	CE	CE	CE	CE	CE	CE	CE	CE

Equipment	Model No.						
	[2]		[3]		[4]		
	7856.120	7856.191	7859.120	7859.130	7859.410	7859.420	7859.430
Packs of	1 pc(s).	1 pc(s).	1 pc(s).	1 pc(s).	1 pc(s).	1 pc(s).	1 pc(s).
Occupied slots in PSM busbar	1	1	1	1	2	2	2
Connector pattern (type)	UTE CEE7/5	Switzerland T23	IEC 60 320 C13	IEC 60 320 C19	IEC 60 320 C13	IEC 60 320 C19 (+ 2 C13)	Earthing-pin CEE7/3 (+ 2 C13)
Number of outputs	4	4	6	4	8	6	6
Colour of slots	black	black	black	black	black	black	black
Lockable connectors (optional)	-	-	■	-	■	■	-
Miniature fuse per output	-	-	-	-	-	-	-
Thermal overload protection	-	-	-	-	-	-	-
Optical LED display (total current)	-	-	■	■	-	-	-
Optical LED display (switching status/status)	-	-	-	-	■	■	■
Illuminated colour display (display of measurements/alarms)	-	-	-	-	■	■	■
Switchable outputs (via CMC III)	-	-	-	-	■	■	■
Energy measurement per module (total values)	-	-	-	-	■	■	■
Dimensions (W x H x D)	52 x 250 x 45 mm				52 x 505 x 45 mm		
Operating temperature	+5 °C...+45 °C				+5 °C...+60 °C (at max 8 A per switch output)		
Ambient humidity (non-condensing)	10 – 95 %						
Material	Extruded aluminium section/plastic						
Approvals	CE	CE	CE	CE	CE	CE	CE

Approvals:

Available on the Internet

Modular PDU (PSM)

PSM measurement modules

PSM measurement modules with CAN bus

for PSM busbars

A power meter and switching functions for the output slots can be added to any PSM busbar with these PSM plug-in modules. The modules are also suitable for upgrading existing PSM installations if it becomes necessary to record the power data or add a switching option for the connected equipment.

There are three variants available with different socket types. In the PSM busbar, the PSM modules occupy two module slots each. Measurements are displayed locally on a backlit LC display. For quick checks, the colour of the display backlight changes to red if current and power limits are exceeded.

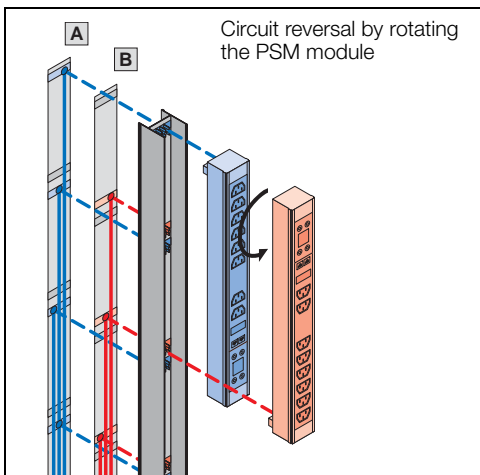

Functions:

- Simple, shock-hazard-protected, plug & play installation with the system operational
- Measurement of power consumption per module
- Output slots may be switched individually and in groups
- Blue LEDs per slot to visually indicate the switching status
- Status LEDs for CAN bus communication per module
- LC matrix display with multi-coloured backlight for local display
- Location sensor for correct display and Web view in 90° increments
- Adjustable limits for voltage, current and active power
- Configurable overload detection per module
- High level of measurement accuracy
- Alarm signalling via the display
- Facilitates the implementation of requirements to ISO 50 001 and EN 50 600-2-2
- Stable aluminium section with plastic socket inserts
- Supports universal connector locking of the IEC 60 320, C13 and C19 slots
- Supports the closure of unneeded IEC 60 320, C13 and C19 slots
- PSM module is easily fitted into and removed from the PSM busbar, for use at different locations
- Compatible with the European PSM busbar range
- Depending on the PSM busbar, up to four modules per bar may be fitted
- In redundant systems, the circuit may be switched over by rotating the module
- For ambient temperatures up to +60 °C



Integration into the CMC III monitoring system

Multiple modules may be interconnected and linked directly to the CMC III enclosure monitoring system via the integral CAN bus interface. The PSM measurement module supports the configuration of an energy data management (EMS) system to ISO 50001. This may be combined with the CMC III. Using the CMC III, the individual output slots of the PSM modules may be switched individually or in groups via the network. Similarly, data logging, including diagrammatic representation, is also available via the CMC III website. Data is forwarded from the CMC III via an Ethernet interface with common protocols such as SNMPv3, Modbus/TCP and OPC-UA. The switch function is easily linked to other sensors connected to the CMC III monitoring system (e.g. CMC III temperature sensor, smoke alarm or DET-AC III extinguisher system). In larger installations, we recommend incorporating the CMC III PU with PSM modules into a DCIM software package (e.g. RiZone).

Additional functions:

- Alarm management via CMC III (e.g. e-mail or text message)
- Visualisation of the switching status on the CMC III website and RiZone
- Up to 16 PSM modules on one CMC III PU (per IP address)
- Rights management via CMC III (e.g. restriction of the switching function)

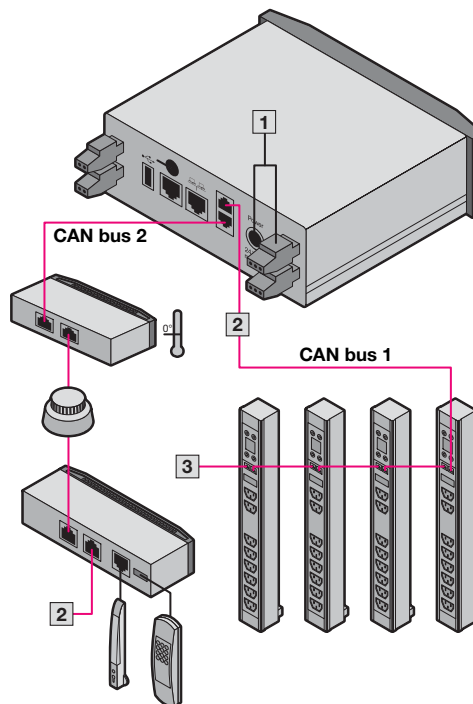

- 1** Voltage supply 24 V (DC) and redundant voltage supply 24 V (DC)
- 2** Supports up to 16 sensors per CAN bus (depending on the power supply/connection combinations)
- 3** Supports up to 8 PSM modules per CAN bus

Modular PDU (PSM)

PSM measurement modules



PSM measurement modules with CAN bus

for PSM busbars

Supply includes:

- PSM measurement module, depending on type
- CAN bus connection cable, 1 m long



Also required:

- PSM busbars and accessories, see page 745
- CMC III Processing Unit/Compact, see page 803
- CMC III accessories, see page 806



Accessories:

- Slot cover, see page 752
- Connector lock, see page 752

Model No.	7859.410	7859.420	7859.430
Packs of	1 pc(s).	1 pc(s).	1 pc(s).
No. of IEC 60 320 C13 slots	8	2	2
No. of IEC 60 320 C19 slots	-	4	-
No. of earthing-pin slots (CEE 7/3 or type F)	-	-	4
Total no. of all switchable outputs	8	6	6
No. of slots required in the PSM busbar	2	2	2
Module dimensions (W x H x D)	53 x 500 x 45 mm		
Section	Aluminium, anodised		
Plastic	PA 6		
Electrical			
No. of infeeds per module	1 pc(s).		
Input voltage	230 V AC		
Input voltage, tolerance	207 – 250 V AC		
Rated current	16 A		
Distribution power per module (at 230 V)	3680 W		
Power supply (via CMC III system, alternatively with power pack 7201.210)	18 – 24 V DC		
Relay type	Dual coil/bistable		
Relay switching load	4000 VA		
Measurement functions			
Voltage V, current A, frequency Hz	■		
Active power kW, active energy kWh	■		
Reactive power kVar, reactive energy kVarh	■		
Apparent power kVA, apparent energy kVAh	■		
Power factor cos φ, crest factor (amplitude factor)	■		
Operating hours meter d, h, min	■		
Measurement accuracy	±1%		
Resettable measurement functions/reset via software/interval measurement			
Active energy kWh	■		
Operating hours meter h	■		
Threshold values (warning/alarm) freely configurable	Voltage, current, active power		
Connectivity / management functions (in conjunction with CMC III)			
Maximum number of usable modules per CMC III Processing Unit	16 (2 x 8)		
Maximum number of usable modules per CMC III Processing Unit Compact	4		
CAN bus for direct connection to CMC III system	2 (RJ45)		
Network functionality (only in conjunction with CMC III system)	IPv4, IPv6, SNMPv3, Modbus/TCP, OPC-UA		
Ambient conditions			
Operating temperature (at max. 8 A per output slot)	+5 °C...+60 °C		
Storage temperature	-20 °C...+70 °C		
Ambient humidity (non-condensing)	rel. humidity 10 – 90%		
Maximum operating altitude	2000 m		
Contamination level	2		
Protection class (IEC 60 529)	IP 20		
Approvals and standards			
Approval	CE		
Standards (excerpt)	Low Voltage Directive 2014/35/EU, EMC Directive, 2014/30/EU, EN 50 600-2-2		

PDU/Modular PDU (PSM)

Accessories

Mounting kit for PSM busbars

Benefits:

- In the VX IT rack, orientation of the busbar is possible either to the rear or to the enclosure interior

Material:

- Sheet steel, zinc-plated

Supply includes:

- 2 mounting brackets
- Assembly parts

To fit enclosure type	Installation options	Packs of	Model No.
1 TE 8000	Static	1 pc(s).	7000.684
2 VX IT	Plug & play on the rack frame	1 pc(s).	7859.060
3 VX IT	Plug & play in the zero-U space	1 pc(s).	7859.065



Connection cable for PSM busbars

Connection cable, 3-phase			
	Length m	Packs of	Model No.
CEE-conforming 5-pole/16 A	3	1 pc(s).	7856.025
Connection cable, 1-phase			
CEE-conforming 3-pole/16 A	3	1 pc(s).	7856.026
Connection cable, UPS, single-phase			
C14/X-COM 10 A/UPS, 1 – 2 kVA	3	1 pc(s).	7856.027
C20/X-COM 16 A/UPS, 3 kVA	3	1 pc(s).	7856.030
Connection cable C19/C20			
16 A	2	1 pc(s).	7200.217
Connection cable C13/C14			
10 A	0.5	2 pc(s).	7856.014



Overvoltage protection PSM

Connected upstream of the busbar.

Rated operating voltage:

- 230 V, 3~

Rated current:

- 16 A

Overvoltage protection:

- Fine fuse (type 3 arrester)

Connections:

- Jack Wago X-COM
- Connector Wago X-COM

Overvoltage protection	Packs of	Model No.
With adaptor connector	1 pc(s).	7856.170

Note:

- With redundant infeed to the PSM busbar, 2 x this item is required



PDU/Modular PDU (PSM)

Accessories



Cable lock PSM

for all modules with EN 60 320 C13 connector configurations

All terminal connection cables are therefore protected against unintentional disconnection of the power supply. Two bars are needed for two cables.

Type	Packs of	Model No.
Bar	20 pc(s).	7856.013

Accessories:

- Optimum locking function is only achieved with connection cable 7856.014, see page 751



Connector lock

for C14 and C20 connectors

The universal lock can be used to latch IEC 60 320 C14 or C20 connectors in place to prevent accidental removal. Latching is adjustable and adapts to standard connector forms. This creates a reliable manufacturer-independent connection for most connection cables commonly available on the market.

Material:

- Plastic (PA 12)

Colour:

- RAL 9005

Packs of	Model No.
20 pc(s).	7979.020



Slot cover

for C13 and C19 slots

The slot cover is used to close open, unused IEC 60 320 C13 and C19 slots. This prevents accidental overloading of individual phases. The cover can be removed at any time using the enclosed release tool (or a slotted screwdriver).

Material:

- Plastic (PA 66)

Colour:

- RAL 9005

Supply includes:

- Release tool

For slots	Packs of	Model No.
C13	10 pc(s).	7955.010
C19	10 pc(s).	7955.015



PDU mounting adaptor

for TE

For installing the power distribution unit PDU in the zero-U space of the TE. The divider kit included with the supply of the PDU is required for mounting.

Material:

- Sheet steel, zinc-plated

Supply includes:

- Assembly parts

Packs of	Model No.
2 pc(s).	7000.688



Modular PDU (PSM) Page 744 **Power basic** Page 733

Autonomous energy metering unit (including differential current monitoring) in a 1 U/19" form factor. The unit is incorporated into the supply lead to the equipment, a PDU basic or a modular PDU without measurement function. All key electrical characteristics are logged in the same way as with a PDU metered. Additionally, the measurement module features an integral differential current measurement (type B) for fault current monitoring of the connected equipment. Consumption data is conveniently retrieved via a network interface or locally via a TFT display. Additionally, all the PDU metered interfaces, e.g. for connecting external sensors and smart handle systems, are available.

Benefits:

- The ideal solution for upgrading existing installations which lack modern measurement functions
- Includes differential current measurement/fault current monitoring
- Extensive measuring functions (as with PDU metered)
- Versions for 16 A/32 A phased current, 1-phase/3-phase
- Versions with connection cable and CEE connectors, ready to use immediately
- Fast upgrade, installation only requires a brief interruption to operation
- Compact 482.6 mm (1 U 19") enclosure with pre-assembled connection cables
- High degree of measurement accuracy (typically $\pm 1\%$)
- Energy-efficient design, minimal inherent power consumption
- Acoustic alarm may be set if certain limits are exceeded (such as fault currents)
- Integral GbE interface with web server for autonomous operation without any additional components
- Sensor interface for up to 8 CMC III/PDU ambient sensors (including access management/handle systems)

Material:

- Extruded aluminium section, anodised

Colour:

- RAL 9005

Protection category IP to IEC 60 529:

- IP 51

Standards:

- EN 62 368-1
- EN 61 000-4
- EN 61 000-6
- EN 55 022

Low Voltage Directive:

- 2014/35/EU

EMC directive:

- 2014/30/EU

RCM measurement module – Inline meter

Model No.		7979.711	7979.712	7979.713	7979.714
	Packs of	1 pc(s).	1 pc(s).	1 pc(s).	1 pc(s).
Version		16 A	32 A	16 A	32 A
Type of connection		CEE connector/coupling	CEE connector/coupling	CEE connector/coupling	CEE connector/coupling
Connection cable/length		H05VV F3G2.5/1 m	H05VV F3G4.0/1 m	H05VV F5G2.5/1 m	H05VV F5G4.0/1 m
Output kW		3.7	7.4	11.0	22.0
Phases		1~	1~	3~	3~
Phase current		16 A	32 A	16 A	32 A

Upgrade solution



Modular PDU (PSM) Page 744 Power distribution unit (PDU) Page 732

Compact overvoltage protection module for protecting terminal equipment (type 3) with alarm contact, for mounting on the enclosure frame. The modules are used to protect sensitive hardware and represent the third or final stage in the overvoltage protection chain. Additionally, other type 1 or type 2 overvoltage protective devices must be present in the building installation or power distribution system.

Benefits:

- Fully wired overvoltage protection solution, ready to connect and use immediately
- For universal use
- High availability – In the event of a fault, arresters can be replaced without interrupting the power supply
- Maintenance-friendly version with a plug-in system for the protective modules
- Versions for 16 A/32 A phased current, 1-phase/3-phase
- Versions with connection cable and CEE connectors
- Ready to use immediately on TN-S networks
- Connection paths L/N and N/PE
- Optical status monitoring directly on the arrester
- Status message via floating alarm contact for forwarding e.g. to building services management
- Space-saving assembly thanks to compact design

Material:

- Extruded aluminium section, anodised

Colour:

- RAL 9005

Protection category IP to IEC 60 529:

- IP 51

Standards:

- IEC 61 643-11
- EN 61 643-11

Low Voltage Directive:

- 2014/35/EU

EMC directive:

- 2014/30/EU

Supply includes:

- Assembly parts

Overvoltage protection module, type 3

Model No.		7979.721	7979.722	7979.723	7979.724
	Packs of	1 pc(s).	1 pc(s).	1 pc(s).	1 pc(s).
Type of connection		CEE connector/coupling	CEE connector/coupling	CEE connector/coupling	CEE connector/coupling
Connection cable/length		H05VV F3G2.5/1 m	H05VV F3G4.0/1 m	H05VV F5G2.5/1 m	H05VV F5G4.0/1 m
Output kW		3.7	7.4	11.0	22.0
Phases		1~	1~	3~	3~
Phase current		16 A	32 A	16 A	32 A

Rittal Configuration System

Customised, modular PDU variants



Use it online at www.rittal.com/rics

IT infrastructure

Rittal – The System.

Faster – better – everywhere.

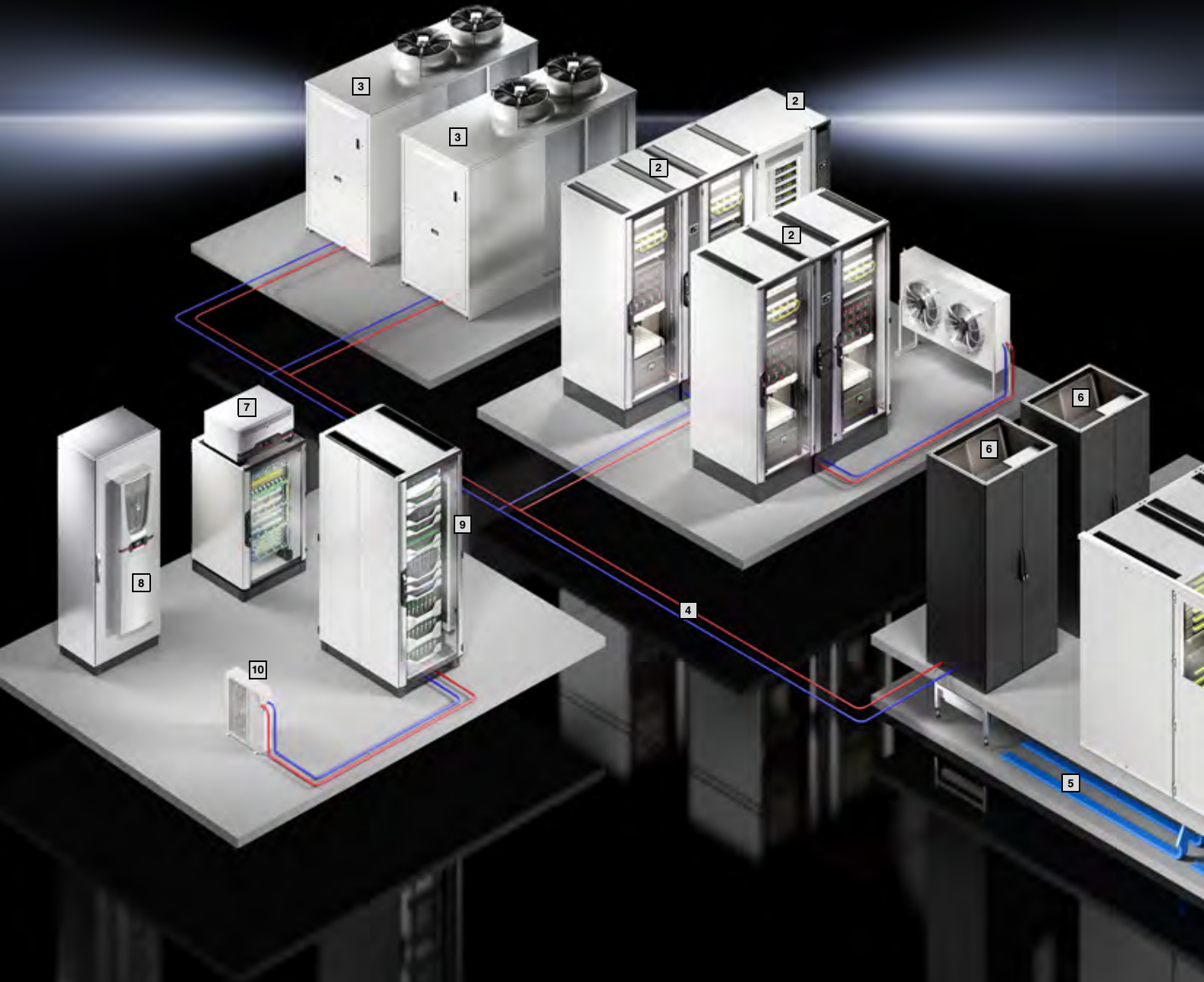

IT cooling

Overview of rack, suite and room cooling	758
Climate control technology for every application	760

Blue e+ IT

Product advantages	762
Roof-mounted cooling unit Blue e+ IT	764
Wall-mounted cooling unit Blue e+ IT	765

Liquid Cooling Unit DX

Product advantages	766
LCU DX, single	768
LCU DX, redundant	770

Liquid Cooling Packages DX

Product advantages	772
LCP rack DX, LCP rack DX/FC	774
LCP Inline DX, LCP Inline DX/FC	775

Liquid Cooling Packages CW

Product advantages	778
LCP rack CW	780
LCP Inline CW, LCP Inline CWG	782
Accessories for IT cooling	784

Aisle containment

Aisle containment	788
-------------------------	-----

Small cooling units

Roof-mounted fan for VX IT in the office sector	789
Fan mounting plate for VX IT, TE	790
Fan expansion kit	790
Cover plates for fan panels FlatBox	791
Vent cover for VX IT	791

CRAC systems

Precision units for data centres	792
--	-----

Chillers for IT cooling

Precision units for high cooling outputs	794
--	-----

Air Handling Units AHU

High-efficiency room cooling for large data centres	796
---	-----

Your benefits

- State-of-the-art climate control technology, from cooling of a single rack through to entire data centres
- Individual climate control concepts for rack, suite and room cooling
- Enhanced security plus superior energy and cost efficiency
- Optimisation with aisle containment and cross-system control concepts
- Energy-efficient cooling using IT chillers
- Minimise your operating costs with free cooling
- Environmentally friendly, thanks to resource savings and reduced CO₂ emissions
- Planning, assembly, commissioning and servicing – all from a single source!

Sample applications

- 1 Aisle containment, see page 788
- 2 Liquid Cooling Package LCP, from page 773
- 3 IT chiller with integral free cooling (partner product), see page 794
- 4 Pipework
- 5 Raised floor for cold air supply
- 6 Computer Room Air Conditioner CRAC (partner product), see page 792
- 7 Roof-mounted cooling unit Blue e+ IT, see page 764
- 8 Wall-mounted cooling unit Blue e+ IT, see page 765
- 9 LCU DX, see page 768
- 10 Inverter-regulated external unit, see page 768

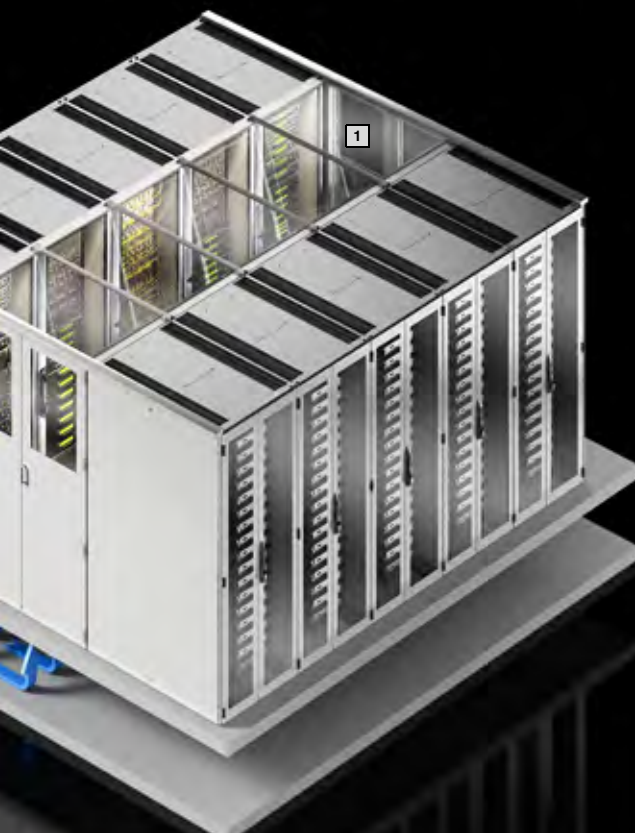

IT cooling

Tailor-made solutions for every application

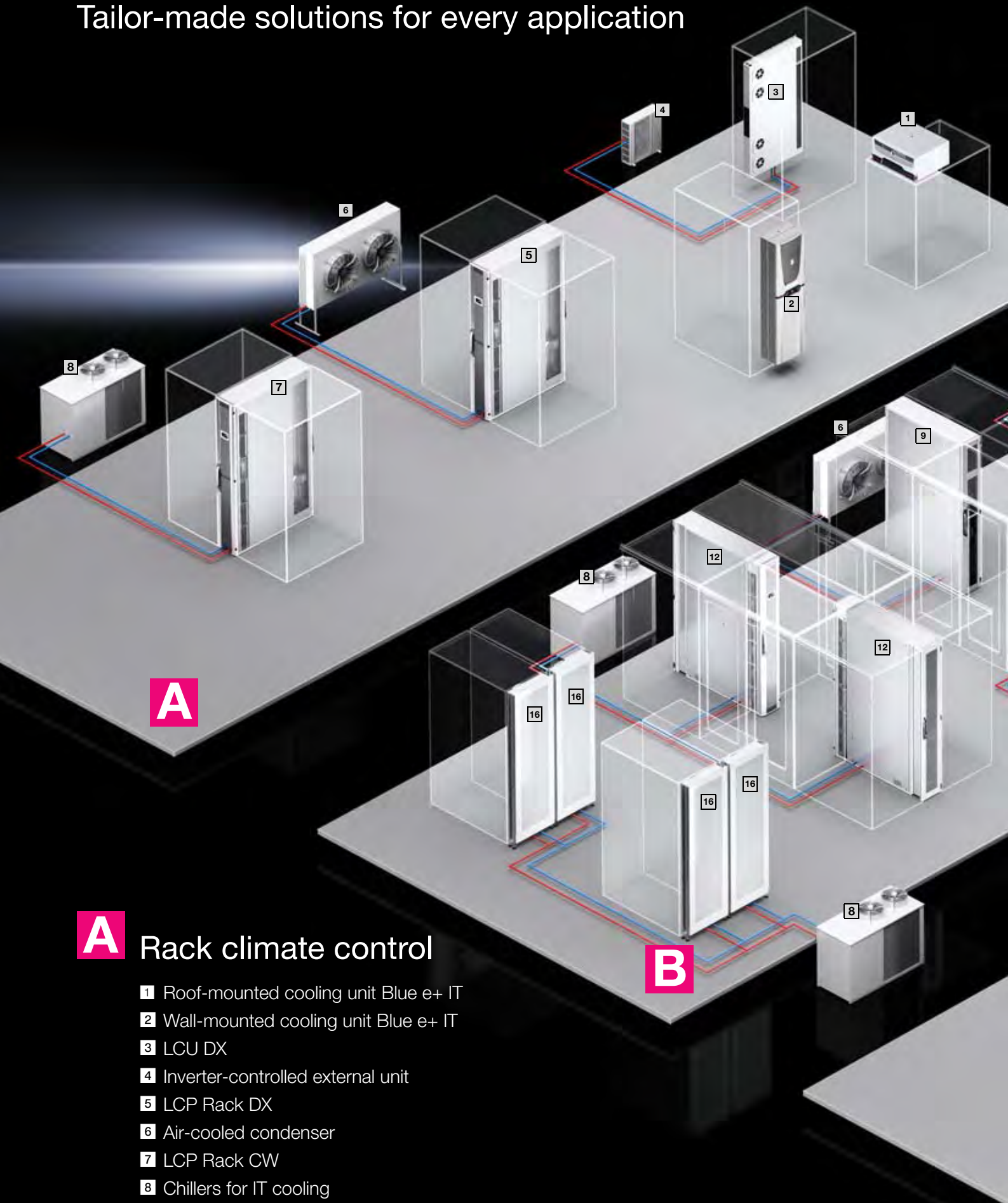

A Rack climate control

- 1 Roof-mounted cooling unit Blue e+ IT
- 2 Wall-mounted cooling unit Blue e+ IT
- 3 LCU DX
- 4 Inverter-controlled external unit
- 5 LCP Rack DX
- 6 Air-cooled condenser
- 7 LCP Rack CW
- 8 Chillers for IT cooling

B Bayed climate control

- 6 Air-cooled condenser
- 8 Chillers for IT cooling
- 10 LCP Inline DX, flush
- 10 LCP Inline DX/FC
- 11 Air-cooled condenser with integral free cooler
- 12 LCP Inline CW, set forward
- 16 LCP rear door CW

C Room climate control

- 6 Air-cooled condenser
- 8 Chillers for IT cooling
- 13 Air Handling Unit AHU
- 14 Computer Room Air Conditioner CRAC
- 15 Aisle containment

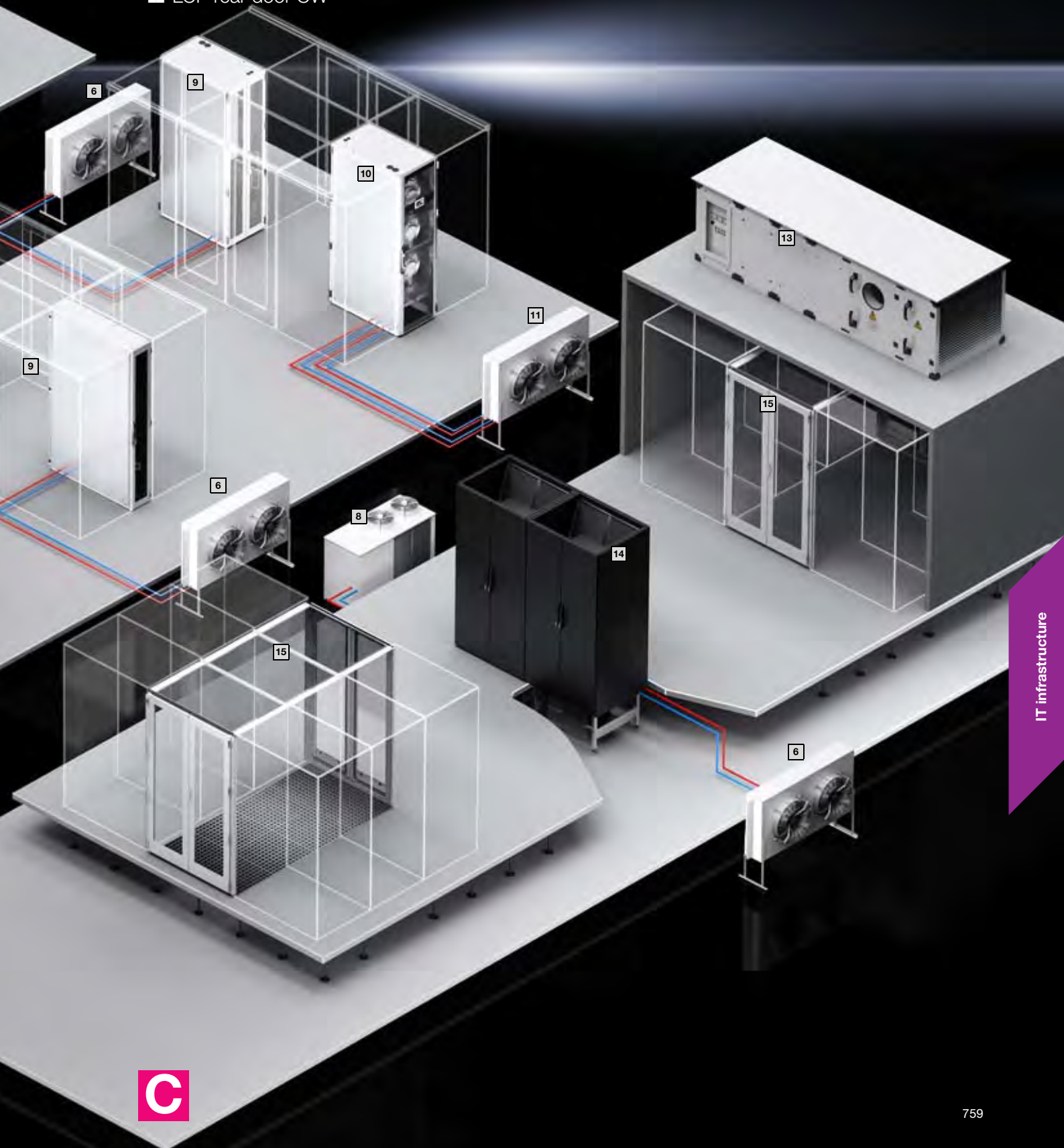

State-of-the-art climate control technology

Bespoke climate control concepts

Cooling unit Blue e+ IT
LCU DX

LCP Inline DX
with aisle
containment

LCP
rack DX

LCP
rear door CW

Computer Room
Air Conditioner
CRAC with aisle
containment

LCP Inline
DX/FC

LCP Inline
CW with
aisle con-
tainment

LCP
rack CW

Low IT thermal load per rack

Medium IT thermal load per rack

From cooling a single rack through to entire data centres – climate control technology from Rittal covers all your applications. Whether you opt for fan systems, refrigerant-based or water-based solutions, reliability and optimum energy and cost efficiency are the paramount considerations.

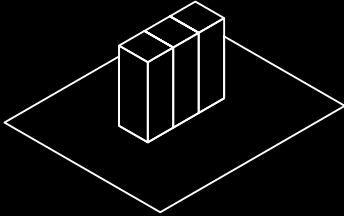

Low density

Professional IT climate control for individual IT racks and mini data centres

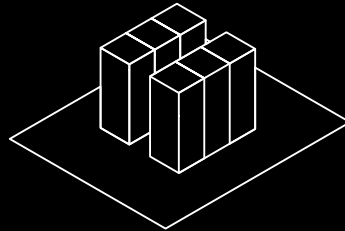

Mid density

Bespoke solutions for more demanding data centres

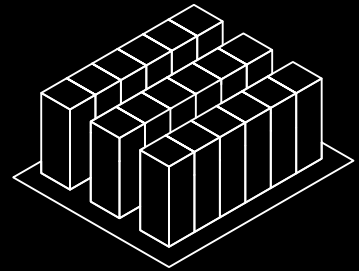

High density

The most powerful solutions for high-end data centres

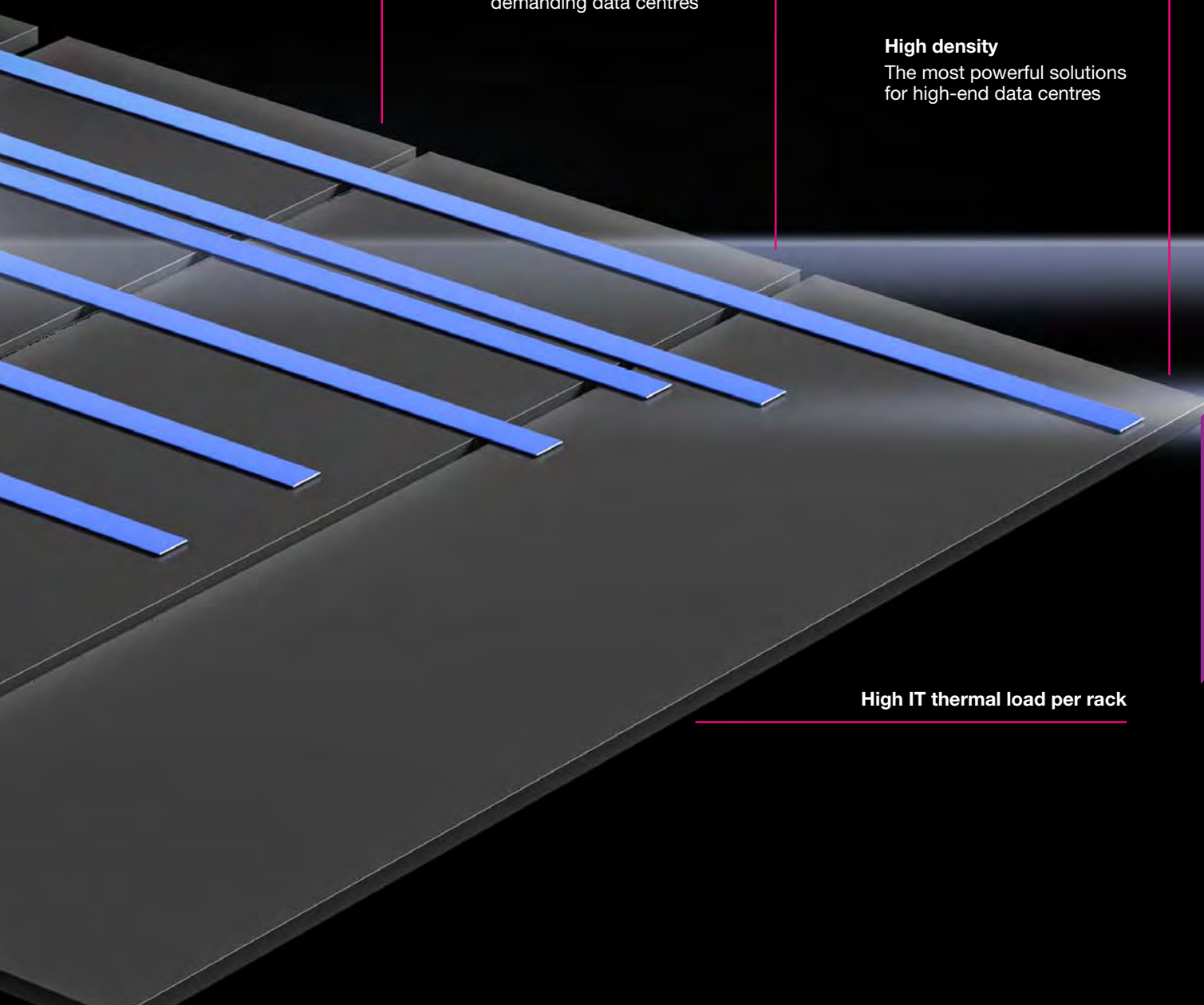

High IT thermal load per rack

Cooling units Blue e+ IT

Rack cooling with innovative hybrid technology

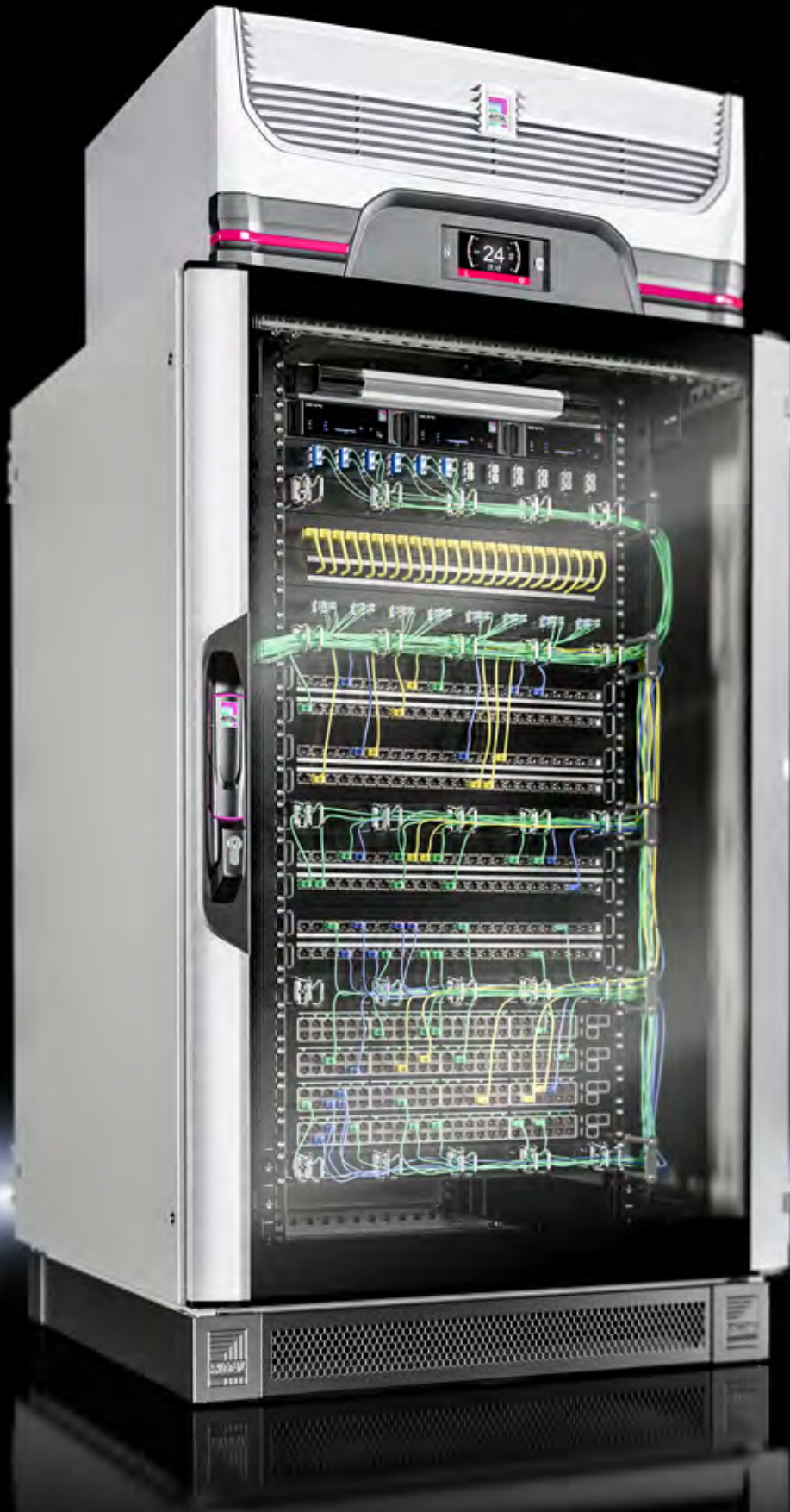

Blue e+ IT – the world's most efficient IT cooling unit

- Cooling of closed IT racks with a heat loss of up to 3 kW in ventilated rooms
- Cooling of edge data centres and network racks in ventilated corridor distributor rooms
- Heat pipe technology reduces operating costs
- Simple installation equals minimal commissioning costs
- Suitable for use in industrial environments, thanks to the high protection category

How are Blue e+ units used?

- The roof-mounted unit is mounted on the racks. The cold air is blasted immediately in front of the 482.6 mm (19") level and drawn in by the IT equipment. The warm air expelled to the rear is drawn in and cooled down again by the roof-mounted unit. Air baffle plates on the 482.6 mm (19") level separate the cold and hot air.
- The wall-mounted unit is mounted on the rear door of the IT rack. The outlet opening of the cooling unit docks onto an air duct which directs the cold air forwards, in front of the 482.6 mm (19") level. There, the cold air is drawn in by the IT equipment, heated, expelled to the rear and then drawn in again by the cooling unit.
- In both applications, air baffle plates on the 482.6 mm (19") level separate the cold and hot air

Simply efficient

- Active cooling circuit with speed-regulated components for demand-based cooling
- Integral heat pipe for passive cooling achieves up to 75% energy savings
- USB interface, Blue e+ app, IoT interface, touchscreen display
- Ethernet connection and data retrieval via SNMP, OPC-UA and Modbus/TCP
- Blue e+ efficiency calculator



Roof-mounted cooling unit Blue e+ IT



Accessories for IT cooling Page 784 IT rack system Page 684 Roof-mounted cooling unit Page 498 IoT interface Page 554

The use of Blue e+ technology makes this bundle ideally suited to the requirements of energy-efficient cooling of IT racks. In combination with the IoT interfaces, it supports communication with various different systems as well as monitoring and energy management.

Benefits:

- Energy savings thanks to speed-regulated components and heat pipe technology
- Suitable for international use due to a unique multi-voltage capability
- Intuitive operation due to touch display and intelligent interfaces

Functions:

- The cold air is directed immediately in front of the 482.6 mm (19") level and drawn in by the IT equipment. The warm air expelled to the rear is drawn in and cooled down again by the roof-mounted unit. Air baffle plates on the 482.6 mm (19") level separate the cold and hot air.

Temperature control:

- e+ controller

Protection category IP to IEC 60 529:

- External circuit IP 54 with pleated filter
- Internal circuit IP 54 with pleated filter

Supply includes:

- Bundle comprised of the following individual components:
- Roof-mounted cooling unit (3185.730)
 - IoT interface (3124.300)
 - Temperature sensor (3124.400)
 - Connection cable (7030.091)
 - Nylon loop cable holder (7111.350)

Note:

- Firmware can be updated using the RiDiag III software (3159.300)

Approvals:

Available on the Internet

Model No.	Packs of	3312.800	Page
Technical specifications, cooling unit			
Total cooling output L30 L22 W		1600	
Width mm		700	
Height mm		308	
Depth mm		560	
Material		Sheet steel	
Colour		RAL 7035	
Rated operating voltage V, ~, Hz		110 - 240, 1~, 50/60 380 - 480, 3~, 50/60	
Type of electrical connection		Plug-in terminal strip	
Operating temperature range		-20 °C...+55 °C	
Refrigerant g		R134a, 590	
Technical specifications, IoT interface			
Protocols		OPC-UA/SNMPv1/SNMPv2/SNMPv3/Modbus/TCP/TCP/IPv4/TCP/IPv6/Radius/Telnet/SSH/FTP/SFTP/HTTP/HTTPS/NTP/DHCP/DNS/SMTP/Syslog/LDAP	

Wall-mounted cooling unit Blue e+ IT



Accessories for IT cooling Page 784 IT rack system Page 684 Wall-mounted cooling unit Page 475 IoT interface Page 554

The use of Blue e+ technology makes this bundle ideally suited to the requirements of energy-efficient cooling of IT racks. In combination with the IoT interfaces, it supports communication with various systems as well as monitoring and energy management.

Benefits:

- Energy savings thanks to speed-regulated components and heat pipe technology
- Suitable for international use due to a unique multi-voltage capability
- Intuitive operation due to touch display and intelligent interfaces

Functions:

- The wall-mounted unit is mounted on the rear door of the IT rack. The outlet opening of the cooling unit docks onto an air duct which directs the cold air forwards, in front of the 482.6 mm (19") level. There, the cold air is drawn in by the IT equipment, heated, blown out to the rear and then drawn in again by the cooling unit.

Temperature control:

- e+ controller

Protection category IP to IEC 60 529:

- External circuit IP 24
- Internal circuit IP 55

Supply includes:

- Bundle comprised of the following individual components:
- Wall-mounted cooling unit (3187.930)
 - IoT interface (3124.300)
 - Temperature sensor (3124.400)
 - Connection cable (7030.091)
 - Nylon loop cable holder (7111.350)

Note:

- Firmware can be updated using the RiDiag III software (3159.300)

Approvals:

Available on the Internet

Model No.	Packs of	3312.810	Page
Technical specifications, cooling unit			
Total cooling output L30 L22 W		3000	
Width mm		450	
Height mm		1600	
Depth mm		294	
Material		Sheet steel	
Colour		RAL 7035	
Rated operating voltage V, ~, Hz		110 - 240, 1~, 50/60 380 - 480, 3~, 50/60	
Type of electrical connection		Plug-in terminal strip	
Operating temperature range		-20 °C...+60 °C	
Refrigerant g		R134a, 1150	
Technical specifications, IoT interface			
Protocols		OPC-UA/SNMPv1/SNMPv2/SNMPv3/Modbus/TCP/TCP/IPv4/TCP/IPv6/Radius/Telnet/SSH/FTP/SFTP/HTTP/HTTPS/NTP/DHCP/DNS/SMTP/Syslog/LDAP	
Also required			
Air duct	1 pc(s).	3312.820	784

Liquid Cooling Unit DX

Efficient cooling with no loss of space



Single or redundant – your compact IT cooling solution

- Cooling of closed IT racks with a heat loss of up to 6.5 kW
- Cooling of edge and micro data centres
- Cooling of IT equipment in uncooled IT rooms or decentralised data centre applications
- Single version (one cooling circuit) and redundant version (two separate cooling circuits) have the same internal unit dimensions, but two independent external units

How are the LCU DX units used?

- The LCU DX is fitted in the IT rack at the side, to the left or right of the 482.6 mm (19") level
- The cold air is blasted in front of the slightly recessed 482.6 mm (19") level across the entire height of the LCU DX and drawn in by the IT equipment
- The warm air expelled to the rear is drawn back in over the full height of the LCU DX at the rear and cooled
- Air baffle plates on the 482.6 mm (19") level separate the cold and hot air

The compact system solution

- Active cooling circuit with speed-regulated components for demand-based cooling
- By only cooling the IT rack rather than the entire room, energy savings are achieved
- Unlike conventional ceiling and wall cassettes, cooling is demand-based
- All waste heat from the IT equipment is dissipated out of the building and emitted to the surrounding environment at the site of the external condenser
- May be combined with integral rack extinguisher systems

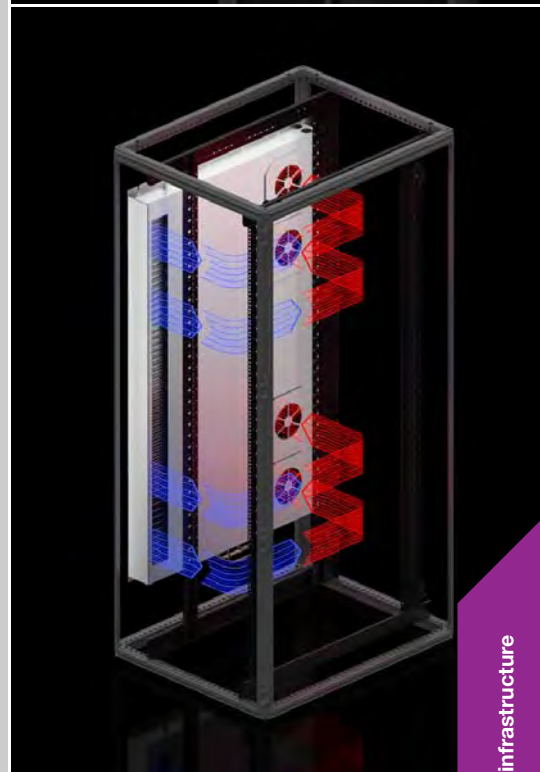

Liquid Cooling Unit



Network/server racks VX IT Page 686 Micro Data Center Page 842

Applications:

- Cooling unit for VX IT server racks and for Micro Data Centers

Benefits:

- Space-saving solution by installing the internal unit in the VX IT server enclosure or the Micro Data Center
- Maximum energy efficiency due to EC fan technology and IT-based control
- Control of the server inlet temperature
- The inverter-controlled compressor adapts the cooling output to the current heat loss inside the enclosure
- Absorbed thermal energy is emitted directly to the ambient air at the (inverter-controlled) external unit's location, without heating up the installation room

Functions:

- The device supports front-to-back air routing typical of IT applications, and regulates the server inlet temperature to the set value

Material:

- Sheet steel, spray-finished

Colour:

- Internal unit: RAL 7035
- External unit: white

Protection category IP to IEC 60 529:

- Internal unit IP 20
- External unit IP X4

Supply includes:

- Internal unit (evaporator coil)
- External unit (inverter-controlled)
- 482.6 mm (19") mounting trim panel with display and control components
- Condensate hose

Note:

- Below the operating limit, fluctuations in the air inlet temperature are possible
- The electrical connection is made on the external unit. The internal unit is supplied by the external unit.

Installation in VX IT:

- 482.6 mm (19") mounting angles, standard or dynamic, must be offset in the width by 50 mm off-centre
- The front distance between the 482.6 mm (19") mounting angles and the front edge of the VX frame must be at least 100 mm
- Two punched sections with mounting flanges are required for attachment on the inner mounting level
- Air baffle plates are required to separate the hot/cold zones within an enclosure
- A base/plinth is required to route the cable downwards

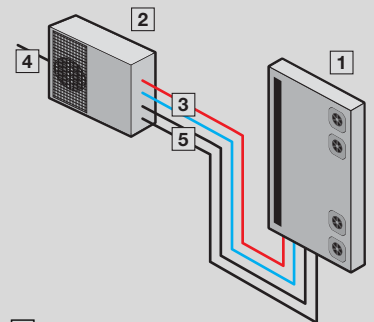

- 1 Internal unit
- 2 External unit
- 3 Refrigerant lines
- 4 Power supply
- 5 Data cable

LCU DX, single

Model No.	Packs of	3311.490	3311.492	Page
Modulation range kW		1 - 3	3 - 6.5	
Useful cooling output L22 L35 kW		3	6.5	
For enclosure width mm		800	800	
For enclosure height mm		≥ 1800	≥ 1800	
For enclosure depth mm		≥ 1000	≥ 1000	
External unit, W x H x D mm		810 x 558 x 310	845 x 700 x 320	
Internal unit, W x H x D mm		105 x 1550 x 820	105 x 1550 x 820	
Type of electrical connection		Connection clamp	Connection clamp	
Rated operating voltage V, ~, Hz		230, 1~, 50	230, 1~, 50	
Rated current max. A		7	15.9	
Pre-fuse A		16	20	
Refrigerant		R410a	R410a	
Duty cycle %		100	100	
Sound pressure level at a distance of 10 m (external unit) dB(A)		40	40	
Operating temperature range (external unit)		-20 °C...+45 °C	-20 °C...+45 °C	
Weight as delivered kg		116.0	121.5	
Accessories				
Refrigerant lines	1 pc(s).	3311.495	3311.496	785



Network/server racks VX IT Page 686 Micro Data Center Page 842

Applications:

- Cooling unit for VX IT server racks and for Micro Data Centers

Benefits:

- Space-saving solution by installing the internal unit in the VX IT server enclosure or the Micro Data Center
- Maximum energy efficiency due to EC fan technology and IT-based control
- Control of the server inlet temperature
- The inverter-controlled compressor adapts the cooling output to the current heat loss inside the enclosure
- Absorbed thermal energy is emitted directly to the ambient air at the (inverter-controlled) external unit's location, without heating up the installation room

Functions:

- The redundant variants have two cooling circuits and controllers inside the internal unit, plus two inverter-regulated external units. The fault and operating hours changeover allows regular switching between the two external units, and ensures automatic changeover in the event of a malfunction or failure.
- The device supports front-to-back air routing typical of IT applications, and regulates the server inlet temperature to the set value

Material:

- Sheet steel, spray-finished

Colour:

- Internal unit: RAL 7035
- External unit: white

Protection category IP to IEC 60 529:

- Internal unit IP 20
- External unit IP X4

Supply includes:

- Internal unit (evaporator coil)
- 2 external units (inverter-controlled)
- 482.6 mm (19") mounting trim panel with display and control components
- Condensate hose

Note:

- Below the operating limit, fluctuations in the air inlet temperature are possible
- The electrical connection is made on the external unit. The internal unit is supplied by the external unit.
- A separate power supply may be needed, depending on the external unit

Installation in VX IT:

- 482.6 mm (19") mounting angles, standard or dynamic, must be offset in the width by 50 mm off-centre
- The front distance between the 482.6 mm (19") mounting angles and the front edge of the VX frame must be at least 100 mm
- Two punched sections with mounting flanges are required for attachment on the inner mounting level
- Air baffle plates are required to separate the hot/cold zones within an enclosure
- A base/plinth is required to route the cable downwards

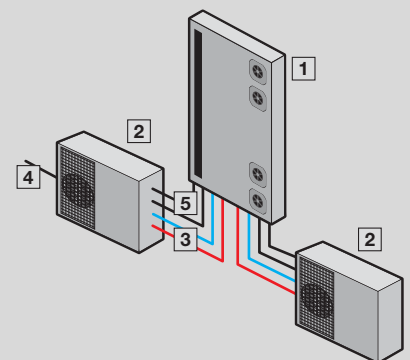

- 1 Internal unit
- 2 External unit
- 3 Refrigerant lines
- 4 Power supply
- 5 Data cable

Liquid Cooling Unit

LCU DX, redundant

Model No.	Packs of	3311.491	3311.493	Page
Modulation range kW		1 - 3	3 - 6.5	
Useful cooling output L22 L35 kW		3	6.5	
For enclosure width mm		800	800	
For enclosure height mm		≥ 1800	≥ 1800	
For enclosure depth mm		≥ 1000	≥ 1000	
External unit, W x H x D mm		810 x 558 x 310	845 x 700 x 320	
Internal unit, W x H x D mm		105 x 1550 x 820	105 x 1550 x 820	
Type of electrical connection		Connection clamp	Connection clamp	
Rated operating voltage V, ~, Hz		230, 1~, 50	230, 1~, 50	
Rated current max. A		7	15.9	
Pre-fuse A		16	20	
Refrigerant		R410a	R410a	
Duty cycle %		100	100	
Sound pressure level at a distance of 10 m (external unit) dB(A)		40	40	
Operating temperature range (external unit)		-20 °C...+45 °C	-20 °C...+45 °C	
Weight as delivered kg		161.0	184.0	
Accessories				
Refrigerant lines	1 pc(s).	3311.495	3311.496	785

Service with manufacturer know-how

Our service experts would be pleased to offer you their advice on our full range of customer services:

- Construction, installation and commissioning
- Fast trouble-shooting
- Inspection
- Leak test
- Professional maintenance
- Original spare parts
- Individual service contracts
- Efficiency and system consulting
- Modernisation



We would be pleased to visit you in person.

Rittal Service.

CMC III – Monitoring system

Computer Multi Control (CMC) is an alarm system for network and server enclosures, standard enclosures, containers and rooms.

1 CMC III Processing Unit

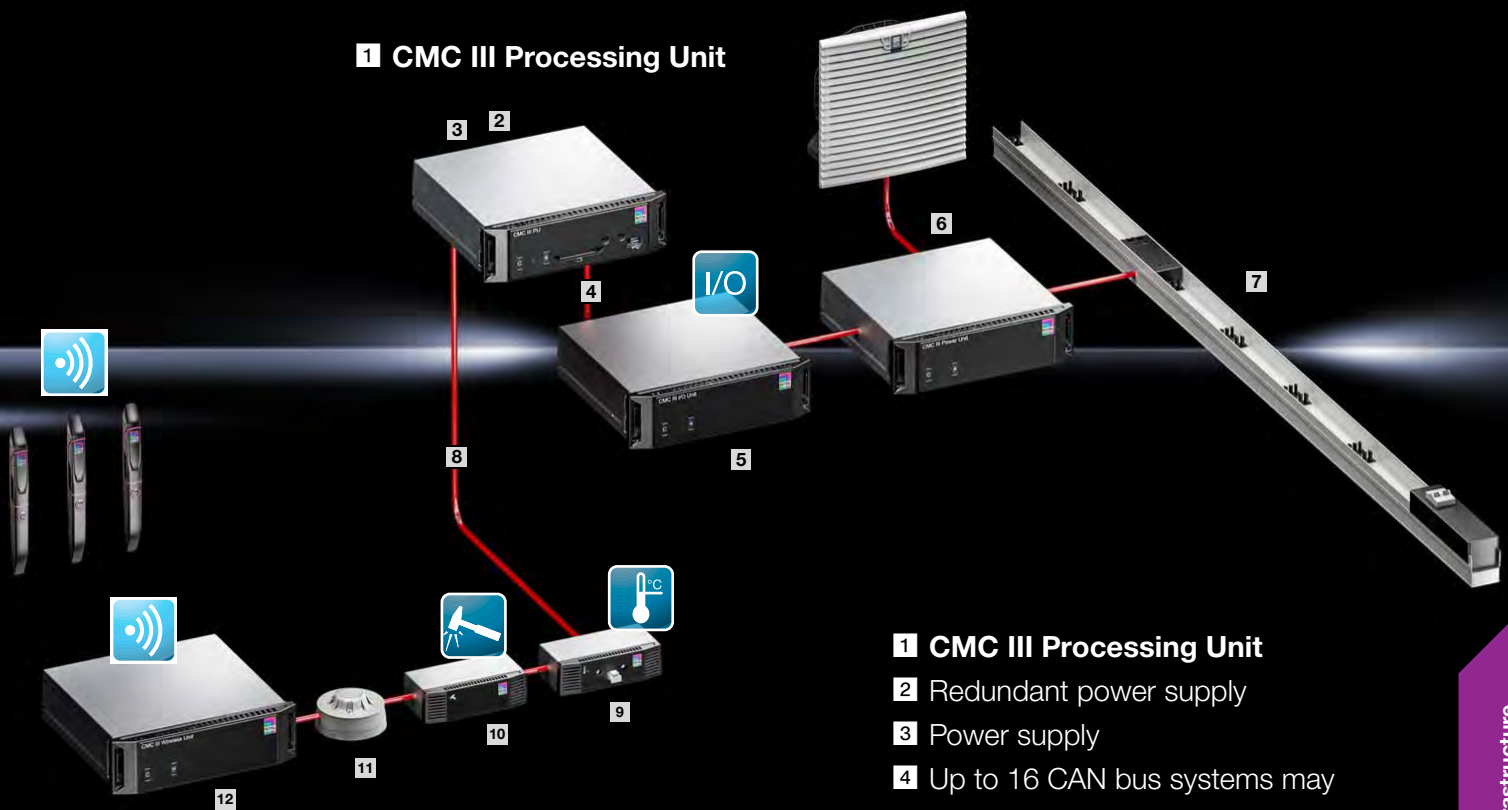

1 CMC III Processing Unit

- 2 Redundant power supply
- 3 Power supply
- 4 Up to 16 CAN bus systems may be connected
- 5 CMC III I/O unit
- 6 CMC III power unit
- 7 CMC III PSM measurement bar for direct connection
- 8 Up to 16 CAN bus systems may be connected
- 9 CMC III temperature sensor
- 10 CMC III vandalism sensor
- 11 CMC III smoke alarm
- 12 CMC III Wireless Unit with radio comfort handles VX

Liquid Cooling Packages DX

The new output categories for suite cooling



LCP DX – An innovative solution for both rack and suite cooling

- Cooling of closed and open IT racks with high heat losses in the output categories 12 kW, 20 kW and 35 kW
- Cooling of IT equipment in uncooled IT rooms or decentralised data centre applications (edge)
- Ideal for IT cooling in small and medium-sized enterprises (SMEs)
- 35 kW DX/FC variant saves energy by using indirect free cooling
- With suite cooling, additional equipment such as UPS, printers and other equipment in the installation room are cooled at the same time

How are the LCP DX units used?

- LCP rack DX units cool up to two closed IT racks to the left and right of the unit. The cold air is blasted in front of the slightly recessed 482.6 mm (19") level across the entire height of the LCP DX and drawn in by the IT equipment. The warm air expelled to the rear is drawn in again across the full height of the LCP DX at the rear and cooled.
- LCP Inline DX units cool multiple open IT racks in suites on both the left and right. To this end, the cold air from the LCP Inline DX is blasted into the cold aisle and drawn in by the IT equipment via the perforated front doors of the IT racks. The air heated by the IT hardware is blasted into the hot aisle via the perforated rear door of the IT rack and from there, is drawn in via the perforated rear door of the LCP Inline DX and cooled again. Aisle containment separates the air in the cold/hot aisle.
- In both cases, air baffle plates on the 482.6 mm (19") level separate the cold and hot air within the IT rack.

Customer benefits

- Active cooling circuit with speed-regulated components for demand-based cooling
- Regulated to the IT inlet temperature
- Hot spot cooling directly at the point of heat generation
- All waste heat from the IT equipment is dissipated and emitted to the surrounding environment at the site of the external condenser
- Depending on the application, this may be combined with integral rack or room extinguisher systems

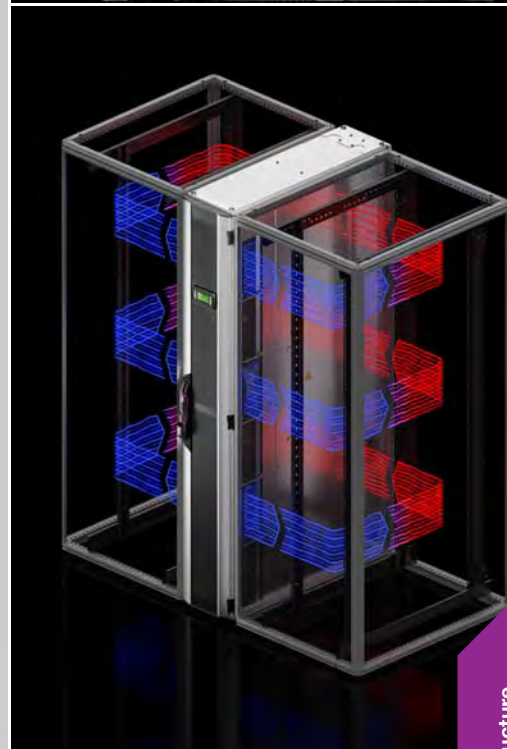

Liquid Cooling Package



Accessories for IT cooling Page 784 Network/server racks VX IT Page 686 System accessories Page 877

Applications:

- Ideal for IT cooling of small and medium-sized locations
- One or two racks can be cooled separately

Benefits:

- Maximum energy efficiency due to EC fan technology and IT-based control
- Minimal pressure loss at the air end, which in turn minimises the power consumption of the fans
- Control of the server inlet temperature
- Thanks to the speed-regulated compressor, the cooling output is ideally adapted to actual requirements

- With redundant temperature sensor integrated at the air end as standard
- Specific maintenance of the LCP DX due to separation of cooling and server racks

Functions:

- The LCP draws in the air at the sides at the rear of the server enclosures, cools it using high-performance compact impellers, and blows the cooled air back into the front part of the server enclosure at the sides
- Absorbed thermal energy is emitted to the ambient air at the external condenser location, without heating up the installation room

IT monitoring:

- Direct connection of the unit via SNMP over Ethernet
- Integration into RiZone

Temperature control:

- Linear fan control
- Inverter-controlled compressor

Material:

- Sheet steel, spray-finished

Colour:

- RAL 7035

Protection category IP to IEC 60 529:

- IP 20

Cooling medium:

- Refrigerant

Optional:

- Humidifier
- Dehumidification and reheater
- Condensate drain pump
- Higher cooling output
- Low-temperature/high-temperature condenser (-40 °C/+53 °C)

Note:

- Variant with UL approval available on request

LCP rack DX, LCP rack DX/FC

Model No.	Packs of	3313.290	3313.410	3313.420	Page
Design		DX	DX	DX	
Modulation range kW		5 - 20	3 - 12	3 - 12	
Total cooling output/Number of fan modules kW		20 / 4	12 / 4	12 / 4	
Width mm		300	300	300	
Height mm		2000	2000	2000	
Depth mm		1200	1000	1200	
Type of electrical connection		Connection clamp	Connection clamp	Connection clamp	
Installation in bayed enclosure suite		Flush	Flush	Flush	
Rated operating voltage V, ~, Hz		380 - 480, 3~, 50/60	380 - 480, 3~, 50/60	380 - 480, 3~, 50/60	
Pre-fuse (T) A		32	20	20	
Air throughput at max. cooling output m ³ /h		4800	4800	4800	
Fans may be exchanged with the system operational		■	■	■	
EC fan		■	■	■	
SNMP card		■	■	■	
Rated current max. A		12.4	7.5	7.5	
Cooling medium		Refrigerant	Refrigerant	Refrigerant	
Refrigerant		R410a	R410a	R410a	
Duty cycle %		100	100	100	
Operating temperature range		+5 °C...+35 °C	+5 °C...+35 °C	+5 °C...+35 °C	
Weight as delivered kg		239.0	181.0	201.0	
Also required					
Condenser unit	1 pc(s).	3311.363	3311.360	3311.360	785

Liquid Cooling Package



Accessories for IT cooling Page 784 Network/server racks VX IT Page 686 Aisle containment Page 788

Applications:

- Ideal for IT cooling of small and medium-sized locations
- One or two racks can be cooled separately

Benefits:

- Maximum energy efficiency due to EC fan technology and IT-based control
- Minimal pressure loss at the air end, which in turn minimises the power consumption of the fans
- Temperature monitoring and control
- With redundant temperature sensor integrated at the air end as standard

- Thanks to the speed-regulated compressor, the cooling output is ideally adapted to actual requirements
- Specific maintenance of the LCP DX due to separation of cooling and server racks
- Using LCP DX/FC variants in combination with indirect free cooling helps to save operating costs

Functions:

- The LCP is designed for siting within a bayed enclosure suite. Hot air is drawn in from the aisle at the rear of the device, cooled by the high-capacity compact impellers, and blown back into the room or cold aisle after cooling.

- The LCP DX/FC variants include both a refrigerant and a water/glycol heat exchanger. There is an additional free cooler integrated into the external condenser.
- Absorbed thermal energy is emitted to the ambient air at the external condenser location, without heating up the installation room

IT monitoring:

- Direct connection of the unit via SNMP over Ethernet
- Integration into RiZone

Temperature control:

- Linear fan control
- Inverter-controlled compressor

Material:

- Sheet steel, spray-finished

Colour:

- RAL 7035

Protection category IP to IEC 60 529:

- IP 20

Optional:

- Humidifier
- Dehumidification and reheater
- Condensate drain pump
- Higher cooling output
- Air filter
- Low-temperature/high-temperature condenser (-40 °C/+53 °C)

Note:

- Variant with UL approval available on request

LCP Inline DX, LCP Inline DX/FC

Model No.	Packs of	3313.390	3313.430	3313.440	3313.450	Page
Design		DX	DX	DX	DX	
Modulation range kW		5 - 20	3 - 12	3 - 12	8 - 35	
Total cooling output/Number of fan modules kW		20 / 4	12 / 4	12 / 4	35 / 3	
Width mm		300	300	300	600	
Height mm		2000	2000	2000	2000	
Depth mm		1200	1000	1200	1000	
Type of electrical connection		Connection clamp	Connection clamp	Connection clamp	Connection clamp	
Installation in bayed enclosure suite		Flush	Flush	Flush	Flush	
Rated operating voltage V, ~, Hz		380 - 480, 3~, 50/60	380 - 480, 3~, 50/60	380 - 480, 3~, 50/60	380 - 480, 3~, 50/60	
Pre-fuse (T) A		32	20	20	40	
Air throughput at max. cooling output m ³ /h		4800	4800	4800	9900	
Fans may be exchanged with the system operational		■	■	■	■	
EC fan		■	■	■	■	
SNMP card		■	■	■	■	
Rated current max. A		12.4	7.5	7.5	22.4	
Cooling medium		Refrigerant	Refrigerant	Refrigerant	Refrigerant	
Refrigerant		R410a	R410a	R410a	R410a	
Duty cycle %		100	100	100	100	
Operating temperature range		+5 °C...+35 °C	+5 °C...+35 °C	+5 °C...+35 °C	+5 °C...+35 °C	
Weight as delivered kg		239.0	181.0	201.0	300.0	
Also required						
Condenser unit	1 pc(s).	3311.363	3311.360	3311.360	3311.370	785

Liquid Cooling Package

LCP Inline DX, LCP Inline DX/FC

Model No.	Packs of	3313.460	3313.470	3313.480	Page
Design		DX/FC	DX	DX/FC	
Modulation range kW		8 - 35	8 - 35	8 - 35	
Total cooling output/Number of fan modules kW		35 / 3	35 / 3	35 / 3	
Width mm		600	600	600	
Height mm		2000	2000	2000	
Depth mm		1000	1200	1200	
Type of electrical connection		Connection clamp	Connection clamp	Connection clamp	
Installation in bayed enclosure suite		Flush	Flush	Flush	
Rated operating voltage V, ~, Hz		380 - 480, 3~, 50/60	380 - 480, 3~, 50/60	380 - 480, 3~, 50/60	
Pre-fuse (T) A		50	40	50	
Air throughput at max. cooling output m ³ /h		9900	9900	9900	
Fans may be exchanged with the system operational		■	■	■	
EC fan		■	■	■	
SNMP card		■	■	■	
Rated current max. A		31.6	22.4	31.6	
Cooling medium		Refrigerant	Refrigerant	Refrigerant	
Refrigerant		R410a	R410a	R410a	
Duty cycle %		100	100	100	
Operating temperature range		+5 °C...+35 °C	+5 °C...+35 °C	+5 °C...+35 °C	
Weight as delivered kg		398.0	300.0	398.0	
Also required					
Condenser unit	1 pc(s).	3311.380	3311.370	3311.380	785

Rittal IT health check – do you know the real condition of your data centre?

Upon request, we can perform a free health check on your data centre:



- Evaluation of your current solution
- Assessment of the risk of obsolescence
- Analysis of energy consumption
- Due consideration of current laws and regulations
- Elaboration of optimal measures, including individual guidance on actions to safeguard your efficiency and availability

IT cooling calculator

For simple calculation of the required cooling output of LCP CW cooling units

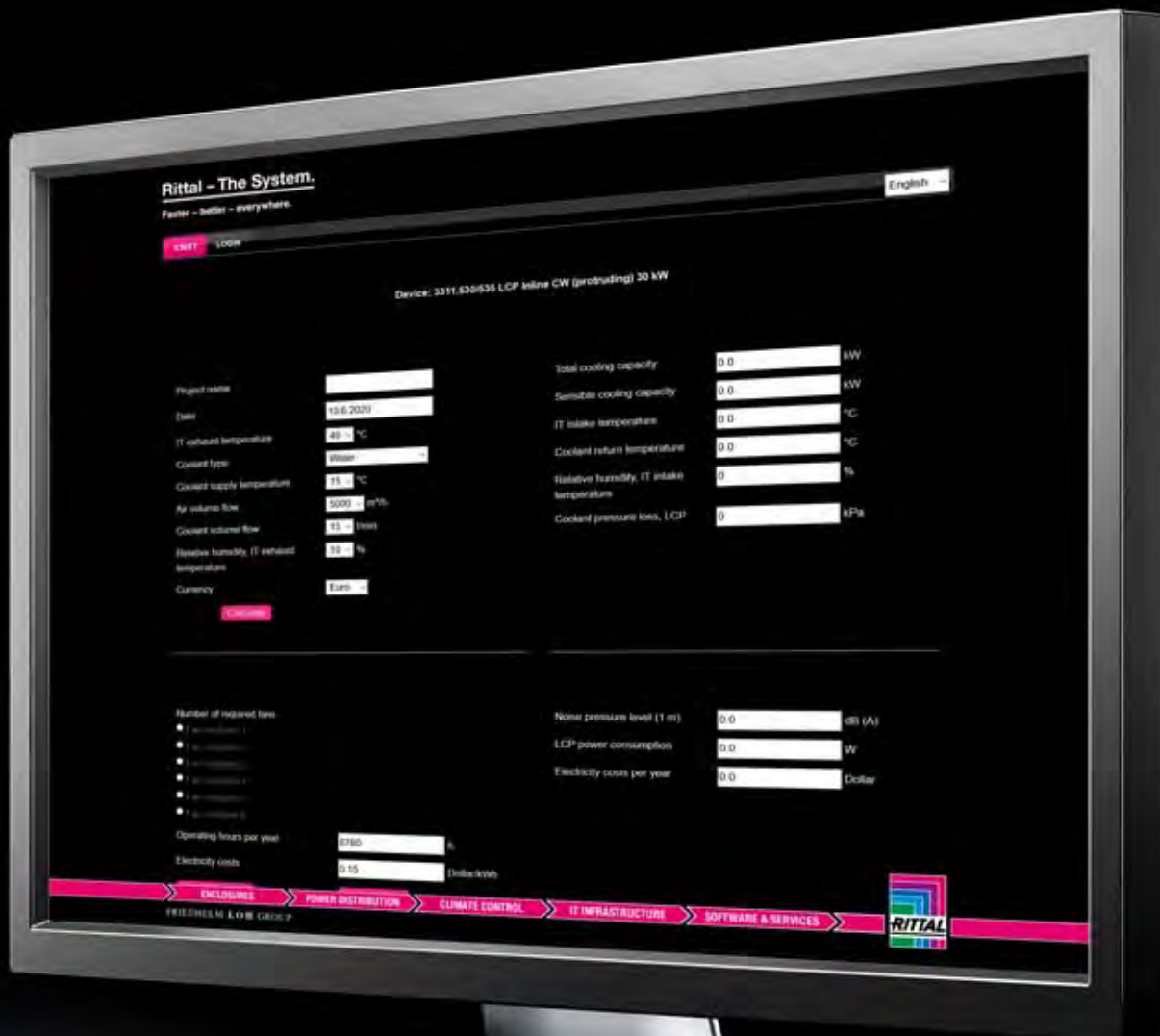

Configure online at www.rittal.com/configurators

Liquid Cooling Packages CW

High-performance cooling



LCP CW – Efficient high-performance cooling

- Cooling of closed and open IT racks with high heat losses of up to 53 kW
- Cooling of IT equipment in uncooled IT rooms or decentralised data centre applications (edge)
- Ideal for IT cooling in medium and large data centre infrastructures as well as high-performance computing (HPC)
- Saves energy by using indirect free cooling
- Cooling of very high heat losses with a small footprint (HPC)

How are the LCP CW units used?

- LCP rack CW units cool up to two closed IT racks to the left and right of the unit. The cold air is blasted in front of the slightly recessed 482.6 mm (19") level across the entire height of the LCP rack CW and drawn in by the IT equipment. The warm air expelled to the rear is drawn in again across the full height of the LCP rack CW at the rear and cooled.
- LCP Inline CW units cool multiple open IT racks in suites on both the left and right. Cold air is blasted into the cold aisle via the perforated front door or at the side of the LCP Inline CW, and from here, is drawn in by the IT equipment via the perforated front doors of the IT racks. Warm air from the IT hardware is blasted into the hot aisle via the perforated rear door of the IT rack and from there, is drawn in via the perforated rear door of the LCP Inline CW and cooled again.
- In both cases, air baffle plates on the 482.6 mm (19") level separate the cold and hot air within the IT rack.

A configurable portfolio

- Cooling output is achieved with high water inlet temperatures, which enables a high proportion of free cooling
- High water return temperatures with LCP CW glycol variants help to improve heat recovery
- All waste heat from the IT systems is dissipated out of the building and emitted to the surrounding environment at the installation site of the external chiller or free cooler
- Depending on the application, this may be combined with integral rack or room extinguisher systems
- A calculator enables the simple selection of Liquid Cooling Packages CW for rack and suite cooling in the IT infrastructure.
- IT cooling calculator:
www.rittal.com/configurators

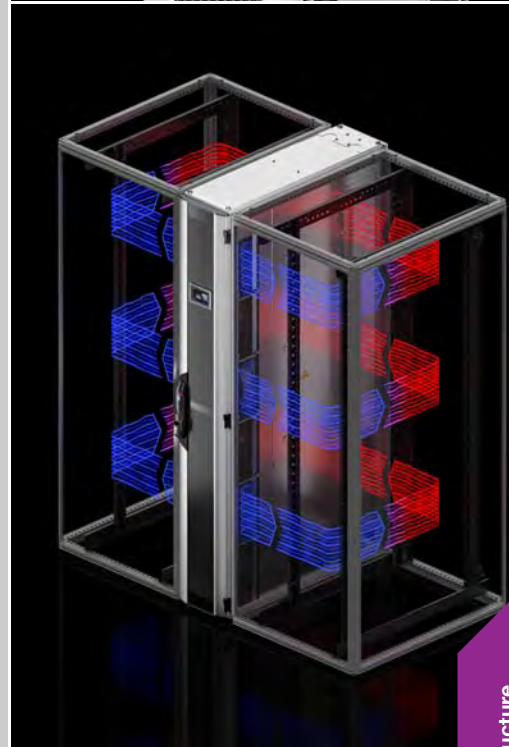

Liquid Cooling Package



Accessories for IT cooling Page 784 Network/server racks VX IT Page 686 Chillers for IT cooling Page 795

Benefits:

- Maximum energy efficiency due to EC fan technology and IT-based control
- Minimal pressure loss at the air end, which in turn minimises the power consumption of the fans
- Control of the server inlet temperature
- With redundant temperature sensor integrated at the air end as standard
- Optimum adaptability due to dynamic, continuous control of the cold water volume flow
- By using high water inlet temperatures, the proportion of indirect free cooling is increased, which in turn reduces operating costs
- Targeted cooling output due to modular fan units

- Fan modules configurable as n+1 redundancy
- Standard 3-phase connection for electrical redundancy
- The separation of cooling and enclosure prevents the ingress of water into the server enclosure
- A footprint of max. 0.36 m² for all cooling services
- Improved heat recovery, thanks to high water return temperatures when using LCP CW glycol variants, for example in combination with a heat pump
- Optimum access for maintenance and servicing from the front and rear
- Tool-free replacement of the fan modules

Functions:

- The LCP draws in the air at the sides at the rear of the server enclosures, cools it using high-performance compact impellers, and blows the cooled air back into the front part of the server enclosure at the sides

IT monitoring:

- Monitoring of all system-relevant parameters such as server air intake temperature, server waste air temperature, water inlet/return temperature, water flow, cooling output, fan speed, leakage
- Direct connection of the unit via SNMP over Ethernet
- Integration into RiZone

Temperature control:

- Linear fan control
- Two-way control valve

Material:

- Sheet steel, spray-finished

Colour:

- RAL 7035

Protection category IP to IEC 60 529:

- IP 20

Optional:

- Fully integrated fire detection and extinguisher system
- Automatic server enclosure door opening
- Direct connection of additional CMC III sensors is supported
- Racks 2200 mm high

Liquid Cooling Package

LCP Rack CW

Model No.	Packs of	3313.130	3313.230	3313.250	3313.260	Page
Design		CW	CW	CWG	CW	
Total cooling output/Number of fan modules kW		10 / 1 20 / 2 30 / 3	10 / 1 20 / 2 30 / 3	38 / 4 40 / 5 44 / 6	48 / 4 51 / 5 53 / 6	
Number of fan modules in supplied state		1	1	4	4	
Width mm		300	300	300	300	
Height mm		2000	2000	2000	2000	
Depth mm		1000	1200	1200	1200	
Type of electrical connection		Connector	Connector	Connector	Connector	
Installation in bayed enclosure suite		Flush	Flush	Flush	Flush	
Rated operating voltage V, ~, Hz		200 – 240, 1~, 50/60 346 – 415, 3~, 50/60	200 – 240, 1~, 50/60 346 – 415, 3~, 50/60	200 – 240, 1~, 50/60 346 – 415, 3~, 50/60	200 – 240, 1~, 50/60 346 – 415, 3~, 50/60	
Air throughput at max. cooling output m ³ /h		4800	4800	4800	8000	
Fans may be exchanged with the system operational		■	■	■	■	
EC fan		■	■	■	■	
Optimised condensate management, even at low water inlet temperatures		–	–	■	–	
Water inlet temperature °C		15	15	15	15	
Permissible operating pressure (p. max.) bar		10	10	10	10	
Duty cycle %		100	100	100	100	
Water connection		DN 40 (G 1½" external thread)	DN 40 (G 1½" external thread)	DN 40 (G 1½" external thread)	DN 40 (G 1½" external thread)	
Weight as delivered kg		225.0	230.0	280.0	260.0	
Accessories						
Fan module	1 pc(s).	3313.016	3313.016	3313.016	3313.016	787
Touchscreen display, colour	1 pc(s).	3311.030	3311.030	3311.030	3311.030	785
Connection hose	2 pc(s).	3311.040	3311.040	3311.040	3311.040	786
Condensate pump	1 pc(s).	–	–	3312.012	–	786

Liquid Cooling Package



Accessories for IT cooling Page 784 **Network/server racks VX IT** Page 686 **Chillers for IT cooling** Page 795 **Aisle containment** Page 788

Benefits:

- Maximum energy efficiency due to EC fan technology and IT-based control
- Minimal pressure loss at the air end, which in turn minimises the power consumption of the fans
- Optimum adaptability due to dynamic, continuous control of the cold water volume flow
- By using high water inlet temperatures, the proportion of indirect free cooling is increased, which in turn reduces operating costs
- Targeted cooling output due to modular fan units
- Fan modules configurable as n+1 redundancy
- Standard 3-phase connection for electrical redundancy
- With redundant temperature sensor integrated at the air end as standard
- The separation of cooling and enclosure prevents the ingress of water into the server enclosure
- A footprint of max. 0.36 m² for all cooling services
- Improved heat recovery, thanks to high water return temperatures when using LCP CW glycol variants, for example in combination with a heat pump
- Optimum access for maintenance and servicing from the front and rear
- Tool-free replacement of the fan modules

Functions:

- The hot air is drawn in from the room or hot aisle at the rear of the device and expelled at the front into the cold aisle after cooling. With this product, a raised floor is not necessary.

IT monitoring:

- Monitoring of all system-relevant parameters such as server air intake temperature, server waste air temperature, water inlet/return temperature, water flow, cooling output, fan speed, leakage
- Direct connection of the unit via SNMP over Ethernet
- Integration into RiZone

Temperature control:

- Linear fan control
- Two-way control valve

Material:

- Sheet steel, spray-finished

Colour:

- RAL 7035

Protection category IP to IEC 60 529:

- IP 20

Optional:

- Direct connection of additional CMC III sensors is supported
- Racks 2200 mm high

Liquid Cooling Package

LCP Inline CW, LCP Inline CWG

Model No.	Packs of	3313.530	3313.540	3313.550	3313.560	3313.570	Page
Design		CW	CW	CWG	CW	CWG	
Total cooling output/Number of fan modules kW		10 / 1 20 / 2 30 / 3	18 / 2 27 / 3 30 / 4	20 / 2 31 / 3 35 / 4	48 / 4 51 / 5 53 / 6	38 / 4 40 / 5 44 / 6	
Number of fan modules in supplied state		1	2	2	4	4	
Width mm		300	300	300	300	300	
Height mm		2000	2000	2000	2000	2000	
Depth mm		1200	1200	1200	1200	1200	
Type of electrical connection		Connector	Connector	Connector	Connector	Connector	
Installation in bayed enclosure suite		Set forward	Flush	Flush	Set forward	Set forward	
Rated operating voltage V, ~, Hz		200 – 240, 1~, 50/60 346 – 415, 3~, 50/60	200 – 240, 1~, 50/60 346 – 415, 3~, 50/60	200 – 240, 1~, 50/60 346 – 415, 3~, 50/60	200 – 240, 1~, 50/50 346 – 415, 3~, 50/60	200 – 240, 1~, 50/60 346 – 415, 3~, 50/60	
Air throughput at max. cooling output m ³ /h		4800	5000	5000	8000	4800	
Fans may be exchanged with the system operational		■	■	■	■	■	
EC fan		■	■	■	■	■	
Optimised condensate management, even at low water inlet temperatures		–	–	■	–	■	
Water inlet temperature °C		15	15	15	15	15	
Permissible operating pressure (p. max.) bar		10	10	10	10	10	
Duty cycle %		100	100	100	100	100	
Water connection		DN 40 (G 1½" external thread)	DN 40 (G 1½" external thread)	DN 40 (G 1½" external thread)	DN 40 (G 1½" external thread)	DN 40 (G 1½" external thread)	
Weight as delivered kg		230.0	220.0	280.0	260.0	280.0	

Accessories

Fan module	1 pc(s).	3313.016	3313.016	3313.016	3313.016	3313.016	787
Touchscreen display, colour	1 pc(s).	3311.030	3311.030	3311.030	3311.030	3311.030	785
Connection hose	2 pc(s).	3311.040	3311.040	3311.040	3311.040	3311.040	786
Rear adaptor		see page	–	–	see page	see page	786
Condensate pump	1 pc(s).	–	–	3312.012	–	3312.012	786

IT cooling

Accessories



Air duct

for wall-mounted cooling unit Blue e+ IT

For cold air infeed in front of the 482.6 mm (19") level in combination with the Blue e+ IT wall-mounted cooling unit.

Benefits:

- One air duct for different enclosure depths

Installation options:

- Mounting in the bottom 3 U of the 482.6 mm (19") level

Material:

- Sheet steel, spray-finished

Colour:

- RAL 9005

Supply includes:

- Assembly parts

Width mm	Height U	For enclosure depth mm	Packs of	Model No.
482.6	3	800 1000 1200	1 pc(s).	3312.820

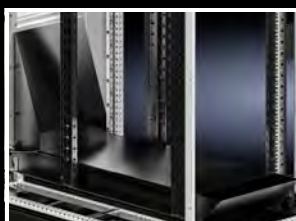

Roof plate

for roof-mounted cooling unit Blue e+ IT

For mounting the roof-mounted cooling unit. The cut-out in the roof plate is arranged so that the roof-mounted cooling unit is positioned centrally on the enclosure.

Material:

- Sheet steel

Surface finish:

- Spray-finished

Colour:

- RAL 7035

To fit Model No.	Width mm	Depth mm	Packs of	Model No.
3312.800	800	800	1 pc(s).	3312.805
3312.800	800	1000	1 pc(s).	3312.806
3312.800	800	1200	1 pc(s).	3312.807



Assembly

- Use the assembly parts of the existing solid roof plate for assembly



Sheet steel door

for wall-mounted cooling unit Blue e+ IT

For mounting the roof-mounted unit. The cut-out in the door is arranged so that the roof-mounted cooling unit is positioned centrally on the door.

Material:

- Sheet steel

Surface finish:

- Spray-finished

Colour:

- RAL 7035

Supply includes:

- Sheet steel door at the rear, 180° hinges
- Comfort handle for profile half-cylinders with security lock 3524 E
- Assembly parts

To fit Model No.	Width mm	Height mm	Packs of	Model No.
3312.810	600	2000	1 pc(s).	3312.815
3312.810	800	2000	1 pc(s).	3312.816

Refrigerant lines

for LCU DX

For connecting the internal and external unit of the LCU DX. Consisting of intake gas line and liquid line. The refrigerant lines are insulated.

Design	Length m	Product-specific scope of supply	Packs of	Model No.
LCU DX 3 kW	20	Intake gas line ½" Liquid line ¼"	1 pc(s).	3311.495
LCU DX 6.5 kW	20	Intake gas line ¾" Liquid line ¾"	1 pc(s).	3311.496



Touchscreen display, colour

for LCP Rack/Inline CW

The display offers the opportunity of directly monitoring key functions of the LCP, and implementing settings.

Supply includes:

- Assembly parts

Packs of	Model No.
1 pc(s).	3311.030



Condenser unit

for LCP DX

The condenser units are necessary for operating refrigerant-based LCPs. Depending on the version, the units have an external condenser and fan, or additionally a free cooler. The variant with free cooler is needed for the combination variant LCP DX/FC. The units are suitable for roof and wall mounting.

Material:

- Sheet steel, spray-finished

Surface finish:

- Powder-coated, zinc-plated

Colour:

- RAL 9003

Supply includes:

- Assembly parts



W x H x D mm	1303 x 915 x 620	2282 x 818 x 552	2219 x 1099 x 850	3048 x 1270 x 1100
Design	Condenser	Condenser	Condenser	Condenser with free cooler
Temperature control	Speed-controlled fan	Speed-controlled fan	Speed-controlled fan	Speed-controlled fan
No. of fans	2	3	2	2
Rated operating voltage V, ~, Hz	230, 1~, 50/60	230, 1~, 50/60	230, 1~, 50/60	230, 1~, 50/60
Cooling medium	-	-	-	Water/glycol
Refrigerant	R410a	R410a	R410a	R410a
Weight kg	29.0	68.0	210.0	285.0
Packs of	1 pc(s).	1 pc(s).	1 pc(s).	1 pc(s).
Model No.	3311.360	3311.363	3311.370	3311.380

IT cooling

Accessories



Vertical shielding

for VX IT

To block the airflow on the left and right of the 482.6 mm (19") level, for enclosure height 2000 mm.

Design:

- Self-adhesive on one side

Material:

- Cellular PU foam
- Flame-inhibiting to UL 94 (HF1)

Colour:

- Anthracite

Sealing between	W x H x D mm	For enclosure width mm	Packs of	Model No.
LCP and 482.6 mm (19") level	210 x 1915 x 110	800	1 pc(s).	3301.320
LCP and 482.6 mm (19") level	110 x 1915 x 110	600	1 pc(s).	3301.370
Side panel and 482.6 mm (19") level	84 x 1910 x 84	600	1 pc(s).	3301.380
Side panel and 482.6 mm (19") level	184 x 1910 x 84	800	1 pc(s).	3301.390



Connection hose

for LCP Rack/Inline CW

Flexible connection hose at the bottom or top, may be cut to required length, including union nuts on both ends for connecting the LCP to existing pipe-work.

Material:

- EPDM

Length m	Water connections	Packs of	Model No.
1.8	1½"	2 pc(s).	3311.040



Rear adaptor

for LCP Inline CW

May be positioned to the rear of the set forward LCP Inline CW to close the existing gap to the rear section.

Material:

- Sheet steel, spray-finished

Colour:

- RAL 7035

Supply includes:

- Adaptor
- With roof plate
- Assembly parts

Width mm	Height mm	Depth mm	Packs of	Model No.
300	2000	200	1 pc(s).	3312.081



Condensate pump

for LCP Rack/Inline CW

For discharging condensate with LCP Rack/Inline CW applications.

Benefits:

- Plug & play installation in all LCP Rack/Inline CW variants

Supply includes:

- Condensate pump
- Condensate hose
- Condensate sensor
- Connection cable
- Assembly parts

Packs of	Model No.
1 pc(s).	3312.012

Fan module

for LCP Rack/Inline CW

To increase the cooling output, individual fan modules may be retro-fitted into the LCPs. Additional integration can also achieve redundancy and reduce the electrical power consumption of the LCP.

Packs of	Model No.
1 pc(s).	3313.016

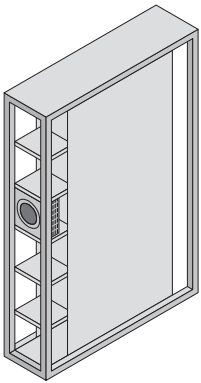

The LCP 3313.130/.230/.530 (max. 30 kW) is supplied with one fan module as standard.

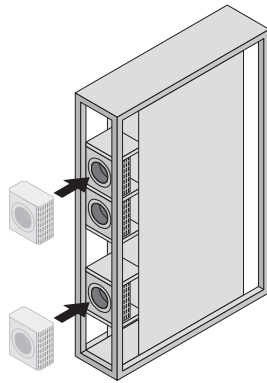

To achieve the max. cooling output, the customer/service should install two additional fan modules.

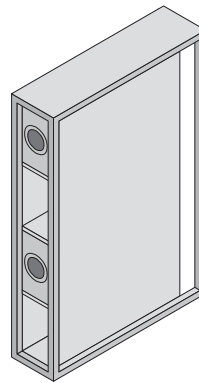

The LCP 3313.540/.550 (max. 30/28 kW) is supplied with two fan modules as standard.

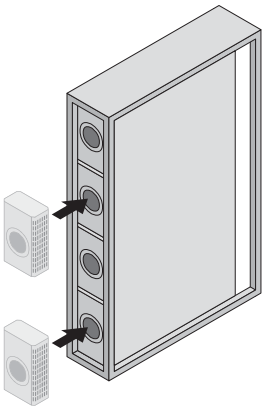

To achieve the max. cooling output, the customer/service should install two additional fan modules.

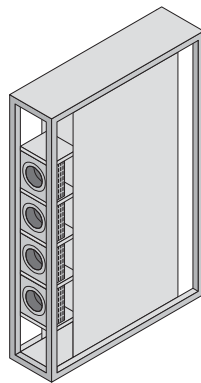

The LCP 3313.250/.260/.560/.570 (max. 35/53/53/35 kW) is supplied with four fan modules as standard.

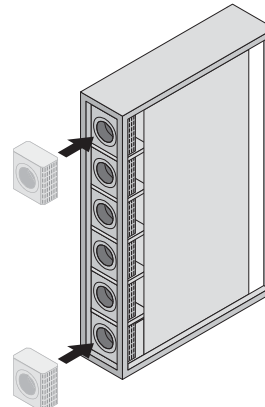

To achieve the max. cooling output, the customer/service should install two additional fan modules.

Note:

- The max. cooling output for the relevant LCP variants can be found in the order tables from page 774

Aisle containment



Liquid Cooling Package Page 772 **Network/server racks VX IT** Page 686

Slimline door element with viewing window and sliding door. Stable roof elements in a composite material with a high level of light permeability. Where required, safety glass may also be used. The aisle width is 1,200 mm.

Applications:

- Depending on the application, aisle containment may be used with CRAC systems or LCP Inline as hot or cold aisle containment

Benefits:

- Increased energy efficiency and performance capability of climate control
- Easily installed and retrofitted, as it is fully compatible with the VX IT rack system
- An inexpensive way to boost the performance of your existing installation, lengthening the investment cycle until a replacement needs to be purchased

Functions:

- Aisle containment is a combination of door and roof components which facilitate consistent separation of the hot and cold air in the data centre. Such separation is pivotal to saving energy and increasing the efficiency of the available climate control technology.

Material:

- Sheet steel, spray-finished

Colour:

- RAL 7035

Photo shows a configuration example with equipment not included in the scope of supply

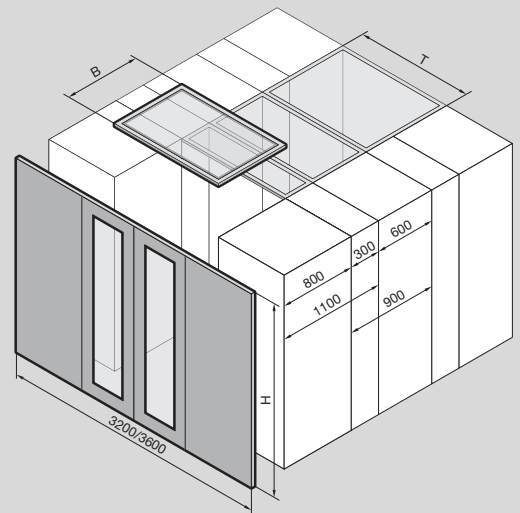

Model No.	Packs of	3311.161	3311.163	3311.170	3311.180	3311.190	3311.200	3311.210	3311.270	3311.280	Page
Design		Door element	Door element	Roof element centre	Roof element centre	Roof element centre	Roof element centre	Roof element centre	Roof element start/end	Roof element start/end	
For enclosure depth mm		1000	1200	-	-	-	-	-	-	-	
Width (B) mm		3200	3600	600	800	300	900	1100	600	800	
Height (H) mm		2000	2000	-	-	-	-	-	-	-	
Depth (T) mm		-	-	1200	1200	1200	1200	1200	1200	1200	
Weight as delivered kg		120.0	150.0	30.0	35.0	20.0	30.0	33.0	30.0	28.0	

Small cooling units

Roof-mounted fans

for VX, VX IT, for the office sector

This roof ventilation concept offers many performance, assembly and cost benefits associated when using integrated ventilation systems. The roof-mounted fan may be ordered with and without a roof plate. For the version with roof plate, the roof-mounted fan is pre-installed. This roof plate also has an integral rear cable entry via a sliding plate with rubber cable clamp strip. Another outstanding feature is the enormous volumetric flow combined with exceptionally low noise levels, making it ideal for use in sensitive office areas.

Benefits:

- Easy assembly, the roof plate variant eliminates the need to create mounting cut-outs
- Fully wired ready for connection

Material:

- Sheet steel, spray-finished

Colour:

- RAL 7035

Supply includes:

- Roof-mounted fans
- Assembly parts

Note:

- Reduction in the specified air throughput to 800 m³/h at 40 Pa counterpressure using two vented base/plinth trim panels

Model No.	3164.230	3164.620
Packs of	1 pc(s).	1 pc(s).
Rated operating voltage V, ~, Hz	230, 1~, 50/60	230, 1~, 50/60
Air throughput, unimpeded air flow m ³ /h	1500	1500
Design	Without roof plate	With roof plate
Rated current A	0.3 / 0.35	0.3 / 0.35
Power consumption W	68 / 81	68 / 81
Width mm	511	800
Height mm	227	240
Depth mm	511	800
Required mounting cut-out mm	410 x 410	-
Fan	Radial	Radial
Operating temperature range	+20 °C...+55 °C	+20 °C...+55 °C
Noise level dB(A)	40	40
Weight kg	19.5	30.0



Accessories:

- Digital enclosure internal temperature display and thermostat integrated into a patch panel 1 U, see page 546
- Digital enclosure internal temperature display and thermostat, see page 546
- Thermostat, see page 547

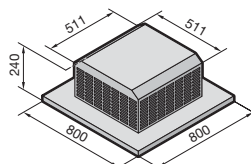
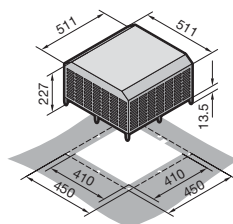

Small cooling units

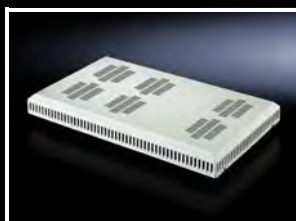

Fan mounting plate

for VX IT, TE

For active ventilation. The unit may optionally be extended with additional fans.

Applications:

- For use in the cut-out integrated into the roof plate

Colour:

- RAL 7035

Supply includes:

- 1 fan unit
- 2 fans
- 1 thermostat
- Connection cable, open-ended
- Assembly parts

Note:

- The noise level given refers to the first fan
- Connection via distributor box or country-specific connector



Accessories:

- Fan expansion kit, see page 790

W x H x D mm	Installation options	No. of fans	Number of fans (max.)	Air through-put per fan m ³ /h	Output per fan W	Rated operating voltage V, ~, Hz	Operating temperature range	Noise level per fan dB(A)	Packs of	Model No.
200 x 59 x 550	In VX IT with W x D (mm): 600 x 600 / 600 x 800 / 600 x 1000 / 600 x 1200 / 800 x 600	2	3	160 / 180	15 / 14	230, 1~, 50/60	+5 °C...+55 °C	37	1 pc(s).	5502.010
340 x 54 x 550	In VX IT with W x D (mm): 800 x 800 / 800 x 1000 / 800 x 1200 In TE 8000 with W x D (mm): 600 x 600 / 600 x 800 / 600 x 1000 / 800 x 600 / 800 x 800 / 800 x 1000	2	6	160 / 180	15 / 14	230, 1~, 50/60	+5 °C...+55 °C	37	1 pc(s).	5502.020



Fan expansion kit

For use as a stand-alone fan, and for upgrading various fan units or to supplement the fan mounting plate.

Supply includes:

- Fan
- Connection cable (0.61 m)
- Assembly parts

W x H x D mm	Air through-put (unimpeded air flow) m ³ /h	Rated operating voltage V, ~, Hz	Power consumption W	Operating temperature range	Noise level dB(A)	Packs of	Model No.
119 x 119 x 38	160 / 180	230, 1~, 50/60	15 / 14	-10 °C...+55 °C	37 / 37	1 pc(s).	7980.000
119 x 119 x 25	108 / 120	230, 1~, 50/60	14 / 12	-20 °C...+70 °C	34 / 34	1 pc(s).	7980.100
119 x 119 x 38	184	48 (DC)	7.7	-20 °C...+70 °C	43	1 pc(s).	7980.148

Small cooling units

Cover plates for fan panels

for FlatBox

To cover unused fan panels when using fans in the FlatBox.

Material:

- Sheet steel

Surface finish:

- Powder-coated

Colour:

- RAL 7035

Supply includes:

- Assembly parts

Packs of	Model No.
6 pc(s).	7507.760



Vent cover

for VX, VX IT

The ideal addition for incorporating sealed racks into an existing central climate control system. The stepped connection is suitable for standard pipe diameters, thereby ensuring effective cooling thanks to targeted air exchange inside the rack.

Material:

- PET-G

Colour:

- Transparent

Supply includes:

- Assembly parts

Note:

- Required cut-out in the roof plate (W x D):
380 x 230 mm

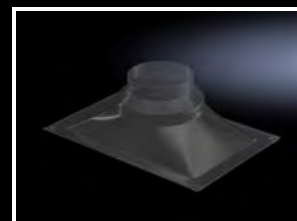

W x H x D mm	Diameter of hose connection mm	Weight kg	Packs of	Model No.
450 x 144 x 300	150/200	0.96	1 pc(s).	7826.750

CRAC systems

Precision climate control units for data centres



CRAC DX/CW – Climate control for large data centres

- Cooling with CRAC systems is ideal for data centres with low to medium outputs per IT rack
- The racks being cooled must be open
- Precision climate control units with accurate temperature and humidity control
- Reliable, familiar technology with a tried-and-tested track record spanning several decades

How are CRAC systems used?

- Downflow: CRAC units extract hot air from the data centre via the unit's open roof. The air is cooled via a heat exchanger and then blasted into the raised floor by fans.
- Upflow: CRAC units extract hot air via the front of the device and blast cold air back into the room via the open roof
- In both cases, air baffle plates on the 482.6 mm (19") level separate the cold and hot air within the IT rack

Tried-and-tested technology

- All waste heat from the IT systems is dissipated out of the building and emitted to the surrounding environment
- There are a range of different options (humidifier, reheater, filter, pressure regulator etc.) available
- Downflow units (raised floor required)
- Upflow units (raised floor not required)
- DX, CW or dual fluid (DX + CW) versions available
- Direct free cooling is supported

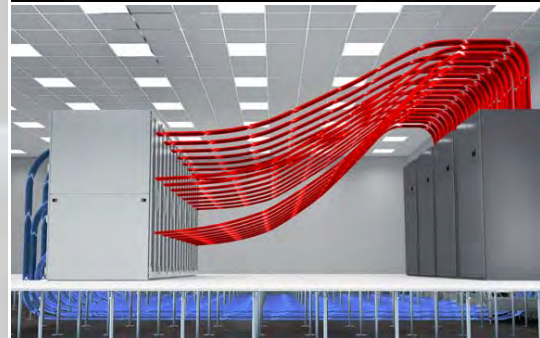

IT chillers

Precision climate control units for high cooling outputs



IT chillers – A continuous supply of cool water

- The ideal solution for server rooms and data centres with medium to high outputs which are supplied with cold water by one or more chillers (e.g. for CRAC CW or LCP CW systems, depending on the heat loss of the IT systems)
- Numerous configurations of the many different variants cover a broad spectrum of required cooling outputs
- Integral or additional free cooling option available for all variants

How do IT chillers work?

- IT chillers are air-cooled and suitable for outdoor siting
- Using large heat exchangers and high-end scroll compressors enables a high level of energy efficiency; depending on the cooling output, cold water is produced on the evaporator coil by one or two independent cooling circuits
- From the evaporator coil, one or two pumps (redundant) supply the equipment (CRACs or LCPs) with cold water. The use of an inverter gives the system a high degree of flexibility to vary the water flow-rate as well as the available pressure (to support large distances between chillers and server rooms)
- The smart device software manages thermal load fluctuations via the regulated use of all or selected compressors and via the pump speed
- At low external temperatures (below the water return temperature), the free cooling function is activated, which helps to save energy by shutting off selected compressors

- 1 Two independent cooling circuits (two or more compressors)
- 2 Two pumps (one operational, one in standby mode)
- 3 Evaporator coil

Customer benefits

- Low operating costs, thanks to a high level of energy efficiency and free cooling option
- Redundancy in selected chillers, thanks to two integrated, independent cooling circuits (over 50 kW) and two redundant pumps
- System redundancy permits cascading of multiple chillers and automatic operational rotation, either a preset times or in the event of a malfunction
- Remote monitoring via Ethernet and polling of status and alarm messages, plus remote operation of device functions

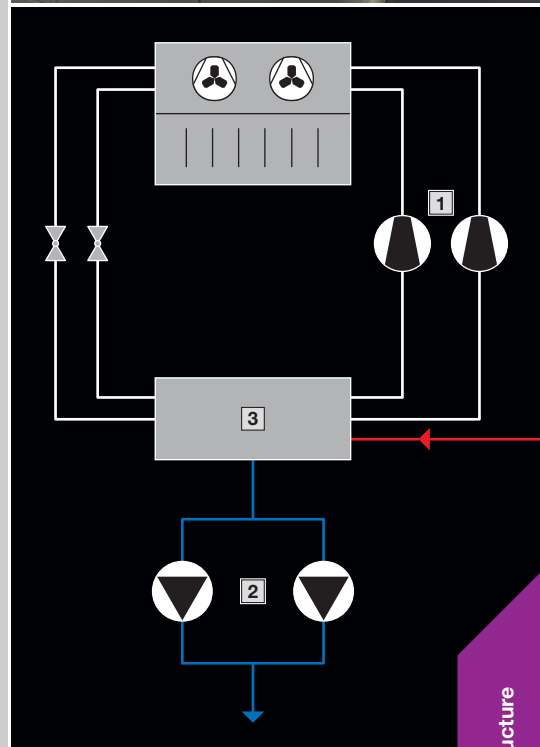

Air Handling Unit

High-efficiency room cooling for large data centres

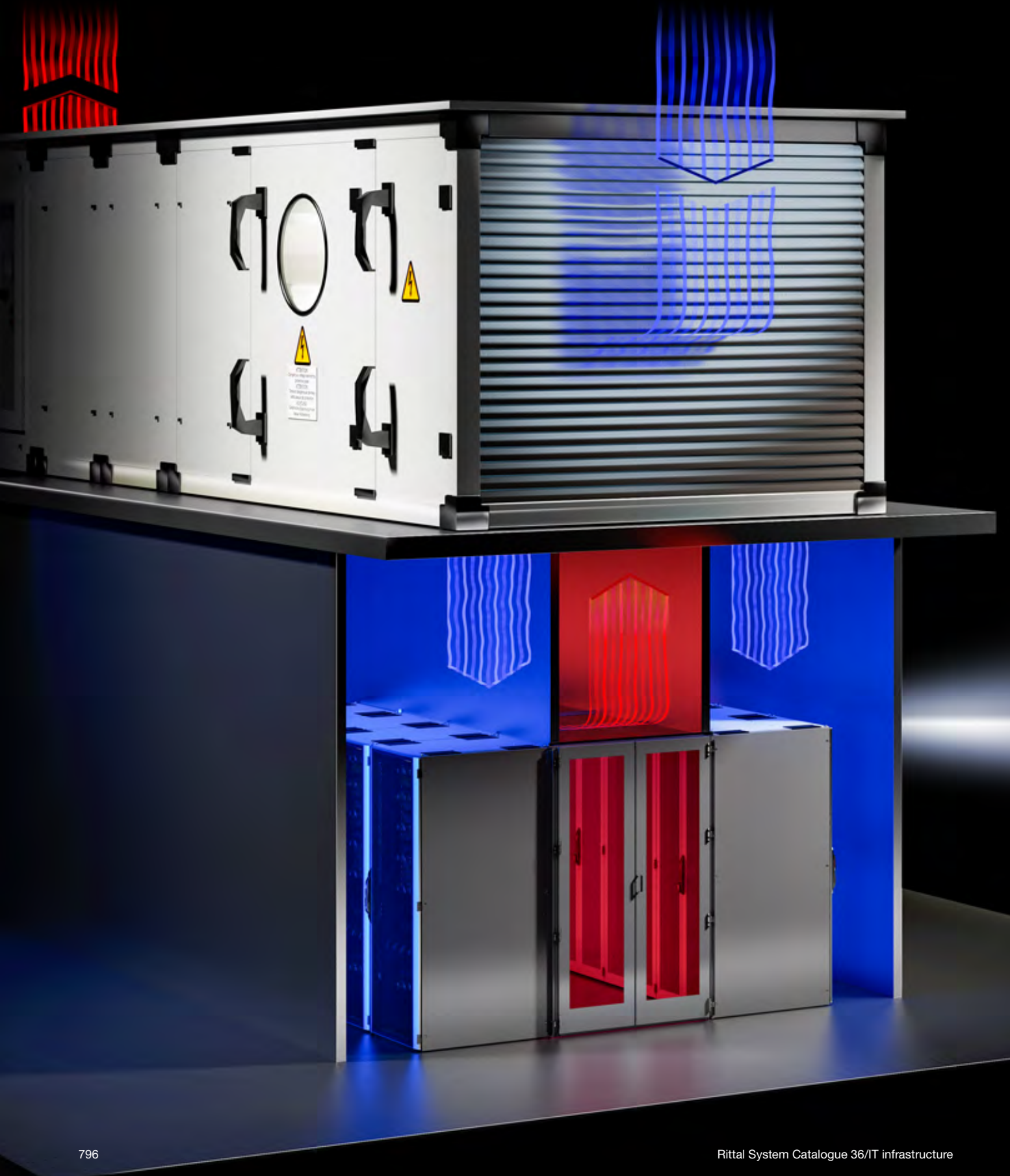

AHU – Cooling for large data centres

- An air handling unit or ventilation system is generally used in large data centres (hyperscale) where large volumes of air need to be moved
- The ventilation system makes extensive cooling output available without taking up space in the data centre. As the thermal loads being dissipated are generally high, a very large volumetric efficiency of the air-flow is required.

How does an AHU work with adiabatic cooling in the data centre?

- In the ventilation system, the hot waste air from the IT systems emits its energy to the cooler ambient air
- Energy is exchanged in the AHU via heat exchangers, e.g. cross-flow (indirect cooling)
- The data centre air does not come into contact with potentially contaminated exterior air
- Air is fed into the data centre via air ducts
- If the exterior air is cooler than the waste air from the IT systems, an active cooling system is not needed (indirect free cooling)
- As the exterior temperature rises, this period can be extended by spraying the heat exchanger with water (adiabatic cooling, or evaporation cooling)
- In enclosure suites, cold and hot zones are separated via aisle partitioning
- Air baffle plates on the 482.6 mm (19") level separate cold and hot air within the IT rack

Integration into the building structure

- The AHU and its infrastructure (air ducts etc.) must be incorporated into the data centre structure. For this reason, AHUs tend only to be used with new-build data centres.
- Retrofitting existing building infrastructures is usually too costly and labour-intensive
- AHUs are custom-designed for each specific project – please contact us for advice

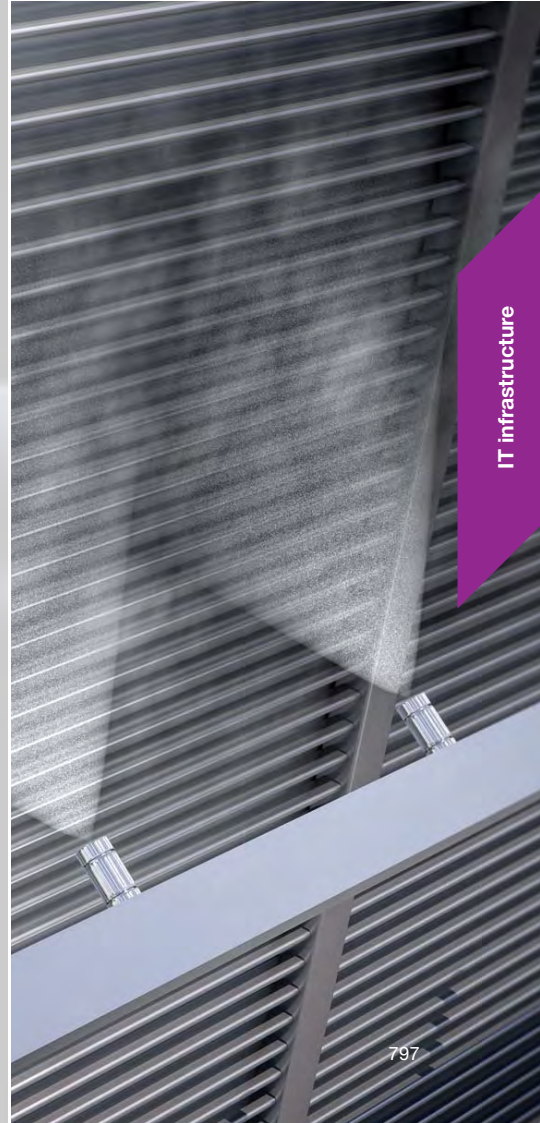

Rittal – The System.

Faster – better – everywhere.



IT monitoring

CMC III – Monitoring system

CMC III system representation	800
CMC III Processing Unit / Compact system overview	802
CMC III Processing Unit / Compact	804

CMC III system components

Control units for CMC III Processing Unit	806
Sensors for direct connection	807
Interface for CMC-TC sensors	808
Products with CAN bus interface for direct connection	809

CMC III access

System representation	810
System components	812

CMC III Automatic Door Opening (ADO)

Automatic Door Opening (ADO)	816
Door control module	817

CMC III accessories

CMC III power pack	818
Programming cable	818
CAN bus connection cable	818
Connection cable/extension	819
Connection/extension cable RJ12	819
Mounting unit, 1 U	819
Cable clamp strap	819
Mounting unit	820
CMC III LTE unit	820
Interference suppressor for fans	820
LED light strip	821

Monitor/keyboard unit

Monitor/keyboard unit, 1 U	822
----------------------------------	-----

Fire alarm and extinguisher system

Fire alarm and extinguisher system DET-AC III master	823
Early fire detection system EFD III	824
Add-on unit DET-AC III slave	825
Accessories	826

Management software

RiZone	828
IT management software	830

Your benefits

- A better overview of your IT infrastructure
- Enhanced security
- Automated processes
- Exceptional cost efficiency
- Huge energy savings
- Simple project management
- Fast installation
- Flexible, individual solutions using standard products from Rittal
- High standard of quality with coordinated standard products

Sample applications

- 1 CMC III, see page 802
- 2 Liquid Cooling Package LCP, see page 772
- 3 Monitor/keyboard unit, see page 822
- 4 Integrated Web interface of a CMC III Processing Unit, see page 806
- 5 Radio comfort handle VX, see page 947
- 6 Fire alarm and extinguisher system DET-AC master, see page 823
- 7 Add-on unit DET-AC III slave, see page 825
- 8 CMC III sensors, see page 807
- 9 RiZone, see page 828

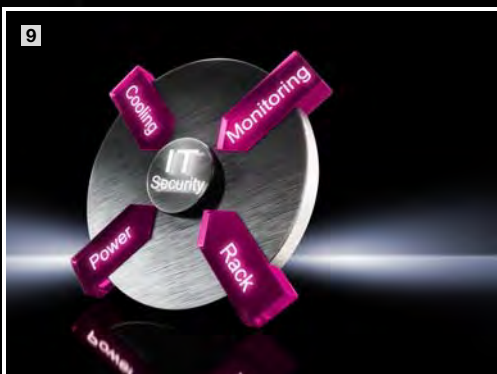

CMC III – Monitoring system

Computer Multi Control (CMC) is a monitoring system for network and server racks, standard enclosures, containers and rooms.

- It monitors temperatures, humidity, access, smoke, energy and many other physical ambient parameters.
- The system is modular and can be flexibly adapted to meet specific monitoring requirements.
- User benefits plus exceptional savings are achieved thanks to monitoring via the network and the automation of security processes.

More information can be found on the Rittal website.

■ CMC III Processing Unit

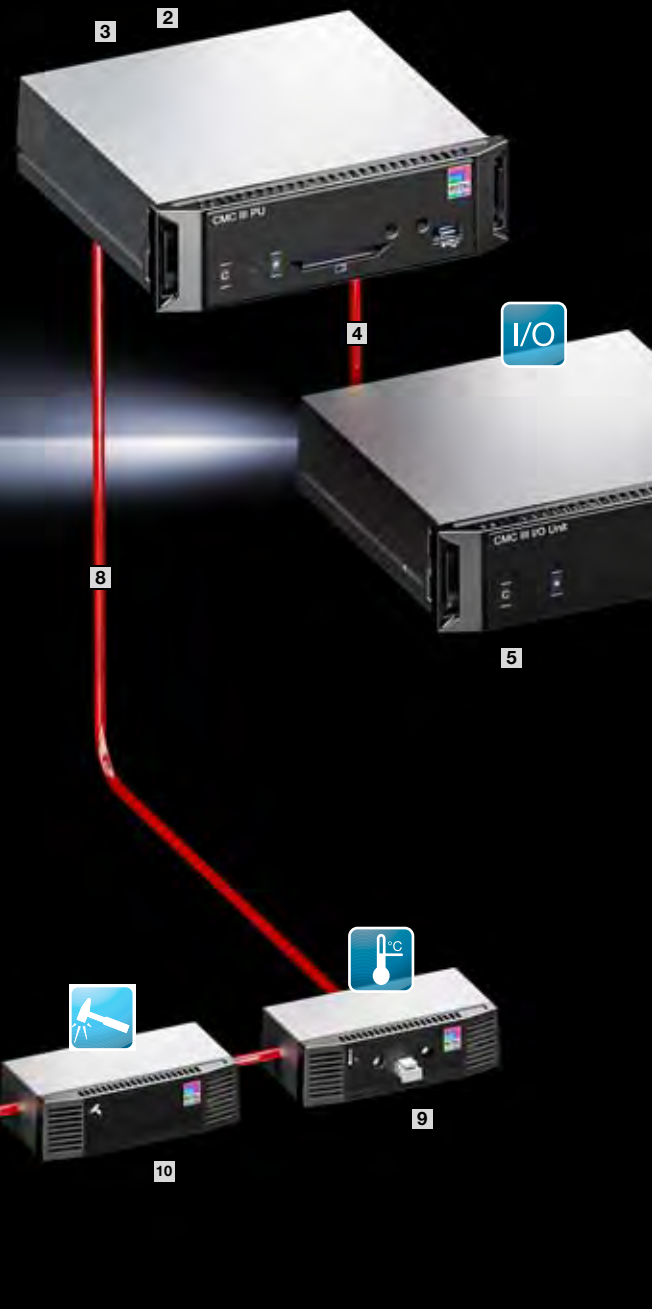

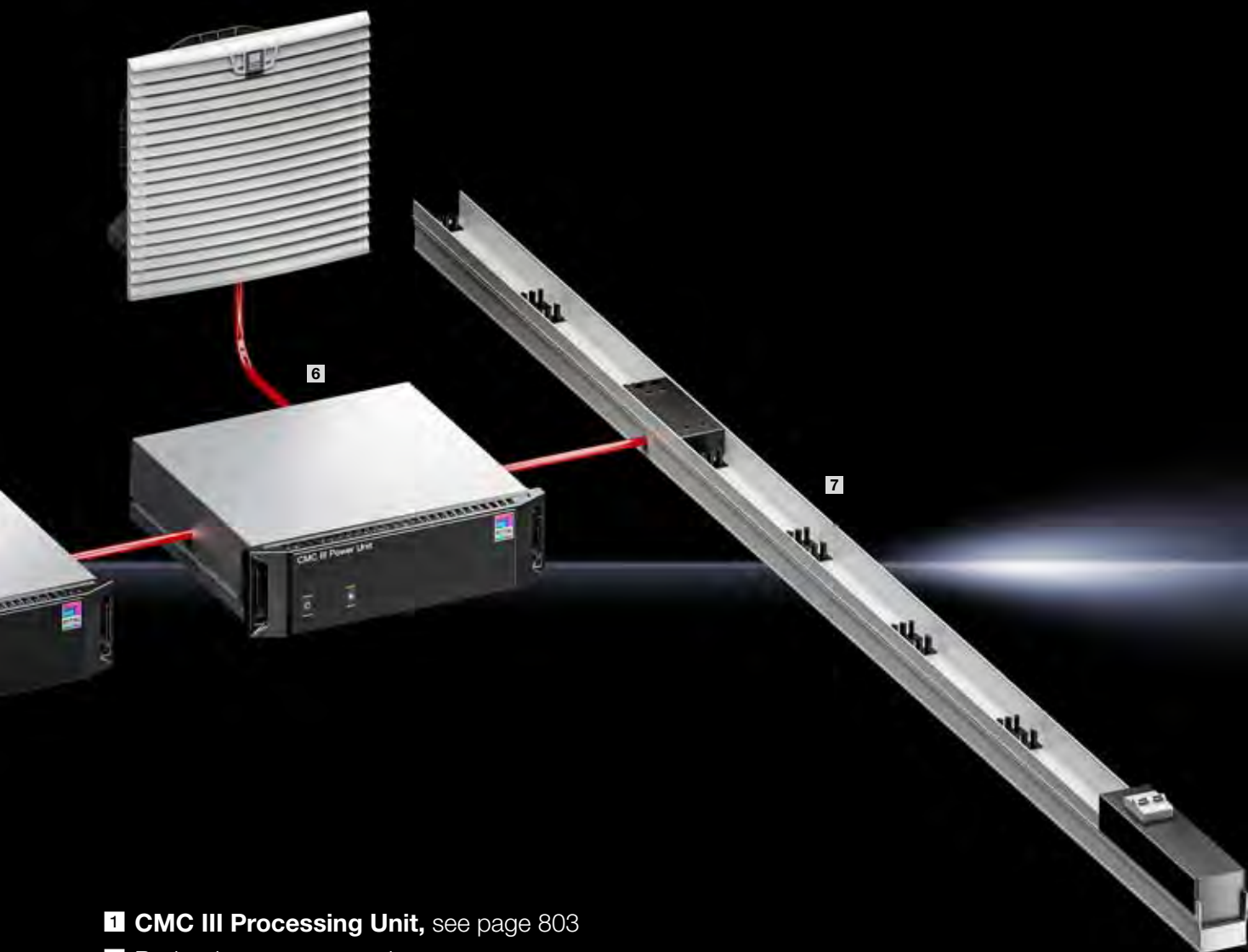

- 1 CMC III Processing Unit**, see page 803
- 2** Redundant power supply
- 3** Power supply
- 4** Up to 16 CAN bus systems may be connected
- 5** CMC III I/O unit
- 6** CMC III power unit
- 7** CMC III PSM measurement bar for direct connection
- 8** Up to 16 CAN bus systems may be connected
- 9** CMC III temperature sensor
- 10** CMC III vandalism sensor
- 11** CMC III smoke alarm
- 12** CMC III Wireless Unit with radio comfort handles VX

CMC III Processing Unit Compact

System overview

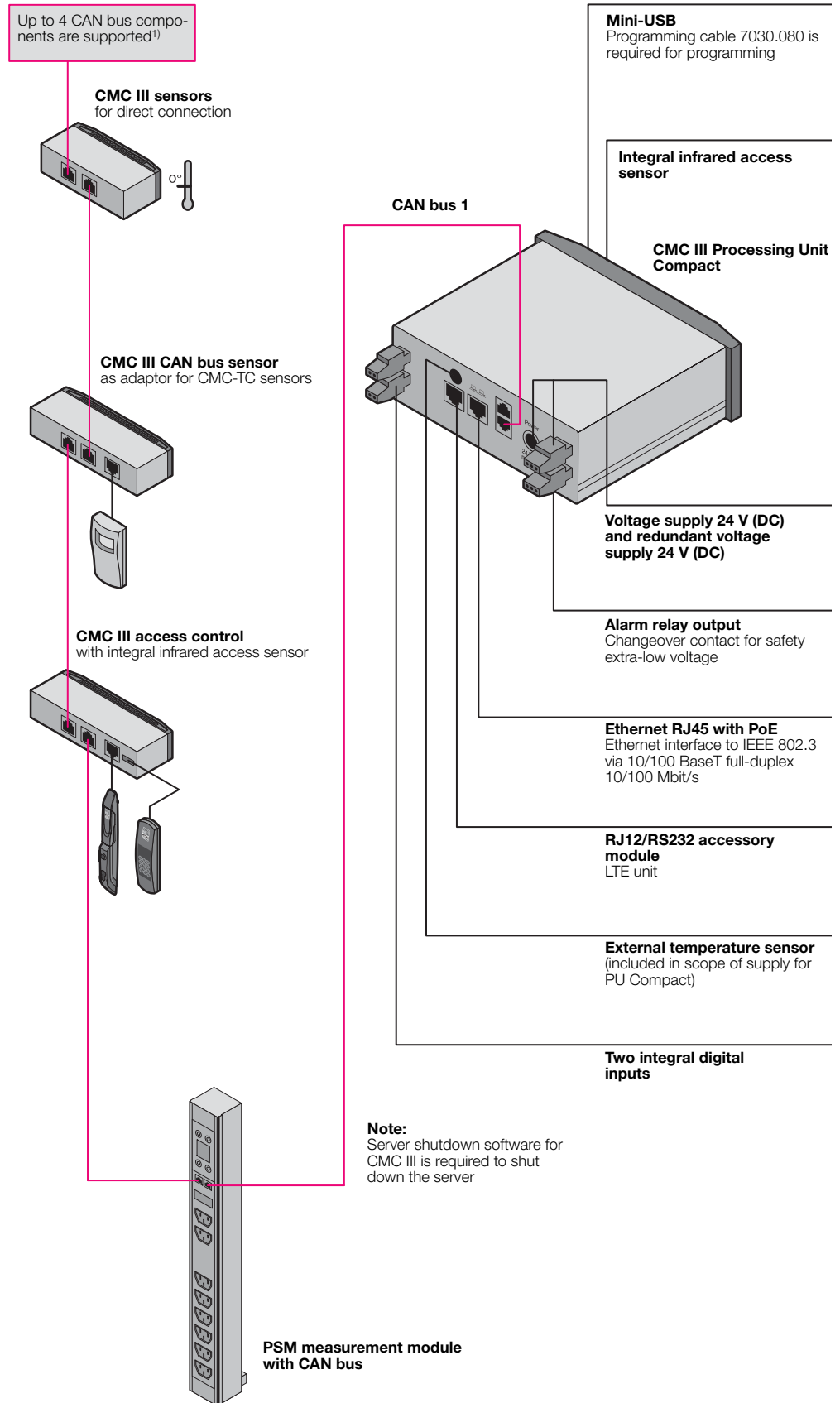

¹⁾ Depending on the power supply/ connection combinations, see page 806 – 812

CMC III Processing Unit

System overview

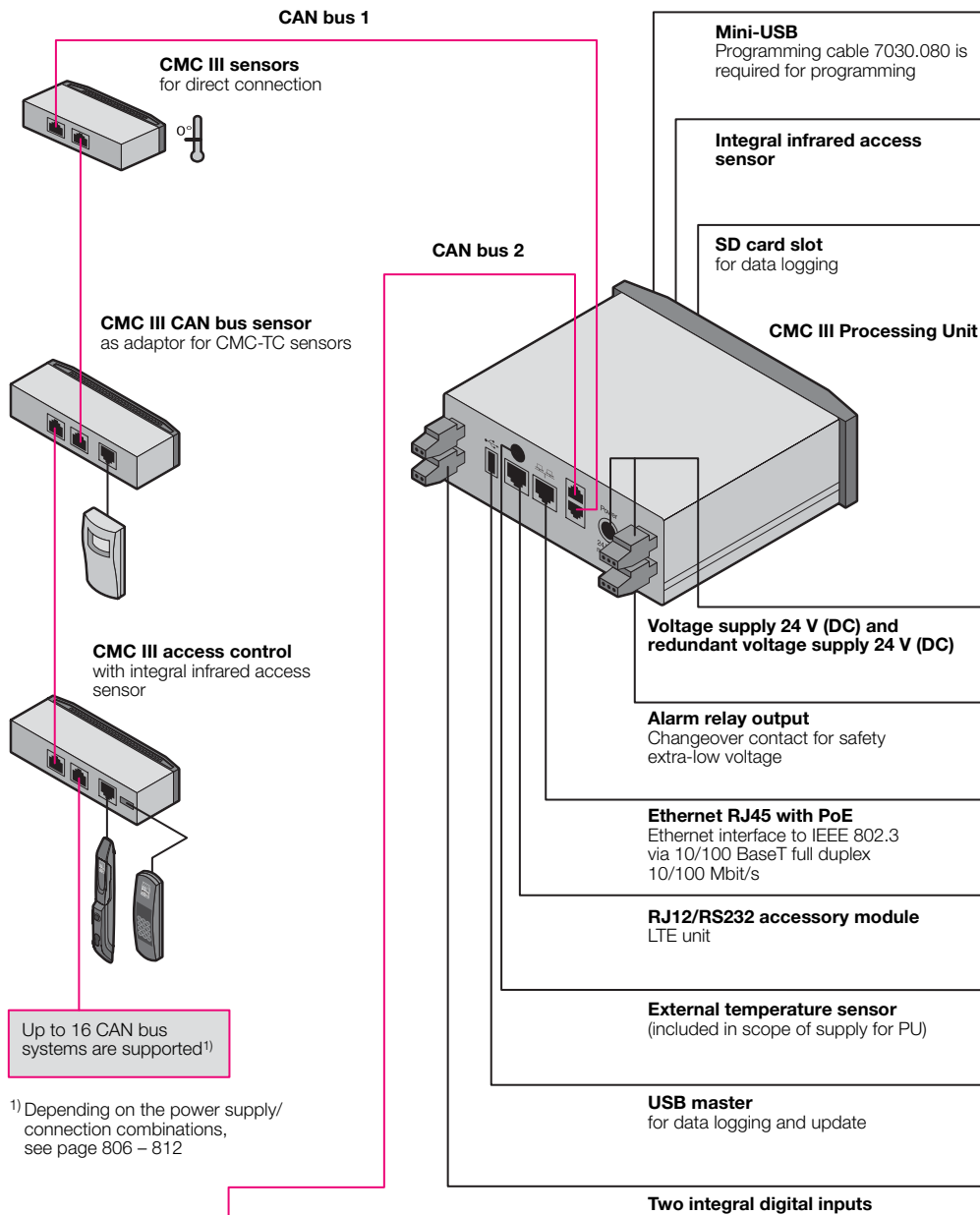

¹⁾ Depending on the power supply/ connection combinations, see page 806 – 812

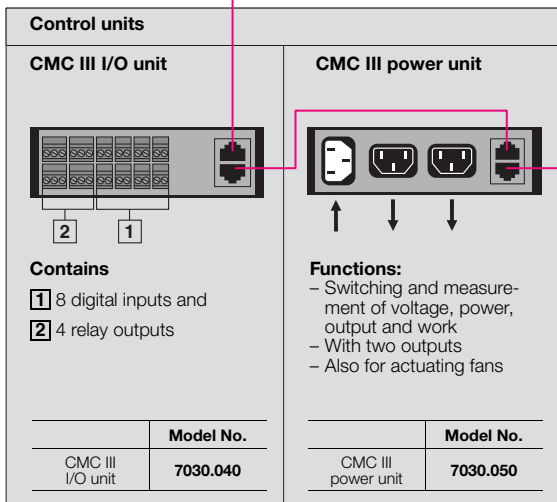

PSM measurement module with CAN bus

Up to 16 CAN bus systems are supported¹⁾



CMC III Processing Unit / Compact



System overview Page 802/803 **Basic modules and connection accessories** From page 806

Central unit of the CMC III monitoring system. In addition, up to 32/4 external sensors/CAN-Bus connection units may be connected to the integral sensors.

Applications:

- Monitoring of enclosures, rooms and containers in the IT environment

Benefits:

- High redundancy due to redundant power supply
- Cost saving due to optimal space utilisation and connection technique
- High flexibility due to modular system
- High reliability due to permanent monitoring of the physical enclosure parameters

Material:

- Plastic

Surface finish:

- Front: Smooth
- Enclosure: Textured

Colour:

- Front: RAL 9005
- Enclosure: RAL 7035

Protection category IP to IEC 60 529:

- IP 30

Supply includes:

- Basic system
- External temperature sensor incl. connection cable (supplied loose)
- Infrared access sensor (integrated)
- Assembly parts for mounting on surfaces

Note:

- Unencrypted protocols may be deactivated for enhanced network security

Approvals:

- UL
- cUL

Photo shows a configuration example with equipment not included in the scope of supply

CMC III Processing Unit / Compact

	Packs of	CMC III Processing Unit	CMC III Processing Unit Compact
W x H x D mm		138 x 40 (1 U) x 120 + 12 (front assembly)	138 x 40 (1 U) x 120 + 12 (front assembly)
Operating temperature range		0 °C...+45 °C	0 °C...+45 °C
Operating humidity range		5 – 95% relative humidity, non-condensing	5 – 95% relative humidity, non-condensing
Sensors/CAN bus connection units		max. 32	max. 4
Max. overall cable length for CAN bus		2 x 50 m	1 x 50 m
Model No.	1 pc(s).	7030.000	7030.010
Interfaces	Network interface (RJ45)	Ethernet to IEEE 802.3 via 10/100BaseT with PoE	Ethernet to IEEE 802.3 via 10/100BaseT with PoE
	Front USB interface	Mini USB for system setting	Mini USB for system setting
	Rear USB interface	for USB stick for data recording up to 32 GB	–
	Front SD-HC slot	1 x up to 32 GB for data recording	–
	Rear serial RS232 (RJ12)	1 x for connecting LTE unit with SMS functions	1 x for connecting LTE unit with SMS functions
	CAN bus (RJ45)	2 x for max. 16 sensors each = 32 sensors in total (quantity restriction, see page 806 – 812)	1 x for max. 4 sensors (quantity restriction, see page 806 – 812)
Inputs and outputs	Digital inputs (terminal)	2	2
	Relay output (terminal)	Changeover contact max. 24 V (DC), 1 A	Changeover contact max. 24 V (DC), 1 A
Operation/signals	Switch/concealed reset button	1 x acknowledgement button/1 x service button	1 x acknowledgement button/1 x service button
	Piezo signal generator	1	1
	LED display	1 x multi-colour OK/warning/alarm	1 x multi-colour OK/warning/alarm
	Rear LED	1 x for the network status	1 x for the network status
Protocols	Ethernet	TCP/IPV4, TCP/IPV6, SNMPv1, SNMPv2c, SNMPv3, Telnet, SSH, (S)FTP, HTTP(S), NTP, DHCP, DNS, SMTP(S), TLS, Syslog	TCP/IPV4, TCP/IPV6, SNMPv1, SNMPv2c, SNMPv3, Telnet, SSH, (S)FTP, HTTP(S), NTP, DHCP, DNS, SMTP(S), TLS, Syslog
Redundant power supply	Input 24 V (DC) (jack)	1 x for connecting the CMC III power pack	1 x for connecting the CMC III power pack
	Input 24 V (DC) (terminals)	1 x for direct connection or for connecting the CMC III power pack	1 x for direct connection or for connecting the CMC III power pack
	Power over Ethernet (PoE)	1 x 15.4 W	1 x 15.4 W
Functions	Time function	Real-time clock, energy-buffered (24 h) without battery/accumulator, with NTP	Real-time clock, energy-buffered (24 h) without battery/accumulator, with NTP
	User administration	Local, LDAP(S), Radius	Local, LDAP(S), Radius
	User interface	Integral Web server with flexible dashboard and mobile view	Integral Web server with flexible dashboard and mobile view
	Control room connection	Integral OPC-UA server, Modbus/TCP	Integral OPC-UA server, Modbus/TCP
	Video monitoring	Incorporation of 1 x network camera	–
Also required			
Mounting unit, 1 U	1 pc(s).	7030.088	7030.088
CMC III power pack	1 pc(s).	7030.060	7030.060
Programming cable	1 pc(s).	7030.080	7030.080

CMC III

System components



Control units for CMC III Processing Unit

Dimensions:

- W x H x D:
138 x 40 x 120 + 12 mm front frame

Material:

- Plastic

Surface finish:

- Front: Smooth
- Enclosure: Textured

Colour:

- Front: RAL 9005
- Enclosure: RAL 7035

Protection category IP to IEC 60 529:

- IP 30

Supply includes:

- Basic system
- Assembly parts for mounting on surfaces



Also required:

- CAN bus connection cable, see page 818
- CMC III Processing Unit, see page 804
- Mounting unit, 1 U, see page 819

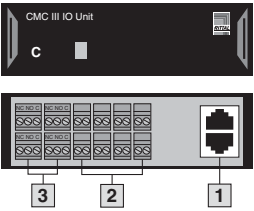
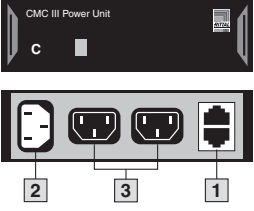
	[1] Connection RJ45 2 x CAN bus	[2] Inputs	[3] Outputs	Model No.	PU Compact	PU
				Packs of 1	Maximum quantity	
 <p>CMC III I/O unit In the software, the relays can be linked to measurement values so that they are actuated under certain circumstances. This allows devices to be controlled and messages to be forwarded. Cannot be operated with the Processing Unit Compact. - Inputs for potential-free signals - Relay output (changeover contact) can handle loads of up to max. 24 V (DC) / 1 A</p>	■	8 x digital	4 x relays	7030.040	-	16
 <p>CMC III power unit The input is switched to the outputs via two relays. In this way, the outputs can be linked to measured values for automatic switching. Fan regulation is one example of a potential application. Manual switching via the CMC III operating interface is likewise supported. Each output is monitored individually, and various values are measured. Cannot be operated with the Processing Unit Compact. - Switches 2 outputs - Measures voltage, current, power, work - Application: Controlling and switching fans, heaters, equipment - Note: For controlling fans, one interference suppressor 7030.051 per fan is required</p>	■	1 x C14 110 – 230 V 50/60 Hz	2 x C13 Aggregate current max. 10 A	7030.050	-	16



CMC III sensors for direct connection

CMC III sensors are used for monitoring the physical environment and can be connected directly to the PU via a CAN bus connection cable RJ45. The sensors may also be linked together to form a bus.

Dimensions:

- 7030.110/.111/.120/.130
W x H x D: 80 x 30 x 40 mm
- 7030.140/.150/.190/.430/.440
W x H x D: 110 x 30 x 40 mm
- 7030.400
Ø x H: 100 x 60 mm

Material:

- Plastic

Surface finish:

- Front: Smooth
- Enclosure: Textured

Colour:

- Front: RAL 9005
- Enclosure: RAL 7035
- Smoke detector: White

Protection category IP to IEC 60 529:

- IP 30









Supply includes:

- Sensor
- Mounting plate
- Assembly parts

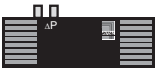

Also required:

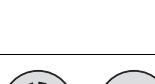
- CAN bus connection cable, see page 818

	[1] Connection RJ45 2 x CAN bus	[2] Inputs	Model No. Packs of 1	PU Compact	PU
				Maximum quantity	
 Temperature sensor - External NTC sensor, 2 m cable - Measurement range for external sensors: -40 °C...+80 °C	■	-	7030.110	4	32
 Temperature/humidity sensor - Measurement range: 0 °C...+55 °C/ 5 - 95% rel. humidity	■	-	7030.111	4	32
 Infrared access sensor - Monitoring with reflector on the door, spacing adjustable	■	-	7030.120	4	32
 Vandalism sensor - Axis: x, y, z - Acceleration limits: -7...7 g, adjustable	■	-	7030.130	4	32
 Analog airflow sensor - External airflow sensor: 4 - 20 mA - Measurement range: 0.2 - 10 m/s - Application: Fans, filters, climate control devices	■	-	7030.140	4	10 ¹⁾
 Analog differential pressure sensor - Two pressure measuring points (infeed via hose) - Measurement range: -500 m Pa...+500 m Pa - Application: Cold aisle containment, raised floor	■	-	7030.150	4	32
 Universal sensor - Choice of digital inputs for an application: - Potential-free signals - S ₀ input for energy measurement systems - 1 Wiegand interface (external access systems)	■	2 x digital may be switched over to pulse input S ₀ or a Wiegand interface 1 x analog 4 - 20 mA	7030.190	4	32
 Smoke detector - Monitors the room air for smoke particles using an optical component	■	-	7030.400	4	32
 Leak sensor - Monitors a given point on the floor of the data centre or enclosure for liquids. The external sensor probe allows free selection of the point to be monitored.	■	-	7030.430	4	32
 Leak sensor, 15 m - Monitors a larger floor area for liquids using the 15 metre long detection cable. The sensor additionally indicates the section of cable where a leak has been detected.	■	-	7030.440	4	32

¹⁾ Max. 5 pieces for power supply with PoE

System components



Interface for CMC-TC sensors

The CMC III CAN bus sensor supports the connection of selected sensors from the CMC-TC system to the current CMC III, allowing old applications to be upgraded with the CMC III Processing Unit / Compact. As well as the two CAN bus connections, the unit also has another connection for one of the CMC-TC sensors. In this way, the unit functions as an interface between the CMC-TC sensor and the current CMC III Processing Unit, and adapts the sensor data to the CAN bus protocol.

Dimensions:

- W x H x D:
110 x 30 x 40 mm

Material:

- Plastic

Surface finish:

- Front: Smooth
- Enclosure: Textured

Colour:

- Front: RAL 9005
- Enclosure: RAL 7035

Protection category IP to IEC 60 529:

- IP 30

Supply includes:

- Sensor
- Mounting plate
- Assembly parts

The following CMC-TC access sensors may be connected to the CMC III CAN bus sensor:

- 1 x temperature sensor
- 1 x analog input 4 – 20 mA
- 5 x access sensors in series
- 1 x airflow sensor
- 1 x smoke detector
- 1 x motion detector
- 1 x digital input
- 1 x digital relay output
- 1 x voltage monitor
- 1 x 48 V voltage sensor
- 1 x leak sensor
- 1 x leak sensor, 15 m sensors
- 1 x door control unit (two connections)
- 1 x DET-AC Plus extinguisher system (three connections)
- 1 x DET-AC Plus early fire detection system (three connections)





Also required:

- CAN bus connection cable, see page 818

	[1]	[2]	[3]	Model No.	PU Compact	PU
	Connection RJ45 2 x CAN bus	Input RJ12	Output RJ12		Packs of	Maximum quantity
<p>1 CMC III CAN bus sensor - For connecting one CMC-TC sensor</p>	■	1 x	-	7030.100 1 pc(s).	4	32
Connectable sensors (max. 1 sensor per CAN bus sensor)						
<p>2 CMC III access sensor VX - Sensor: Reed contact/magnet - Max. 5 reed contacts in series - 0.5 m cable included with the supply</p> <p>Also required: - Connection cable RJ12 for connecting a sensor, see page 819 - Extension cable RJ12 for connecting more sensors in series, see page 819</p>	-	-	1 x	7030.128 1 pc(s).	-	-
<p>3 CMC motion detector - Sensor: Infrared - 2 m cable included with the supply</p>	-	-	1 x	7320.570 1 pc(s).	-	-

Products with CAN bus interface for direct connection

	Model No.	PU		Page	
		Compact	PU		
Maximum quantity					
	PSM measurement bars 16 A, with 2 infeeds	7859.050	4	8	747
	PSM measurement bars 32 A, with 1 infeed	7859.053	4	8	747
	PSM measurement module with CAN bus, 8 x C13	7859.410	4	16	750
	PSM measurement module with CAN bus, 2 x C13, 4 x C19	7859.420	4	16	750
	PSM measurement module with CAN bus, 2 x C13, 4 x earthing-pin	7859.430	4	16	750
	Fire alarm and extinguisher system DET-AC III master	7338.121	4	16	823
	Add-on unit DET-AC III slave	7338.321	4	16	825
	Early fire detection system EFD III	7338.221	4	16	824
	NH measurement module for NH fuse-switch disconnectors, size 00	9343.070	4	8	333
	NH measurement module for NH fuse-switch disconnectors, size 1	9343.170	4	8	333
	NH measurement module for NH fuse-switch disconnectors, size 2	9343.270	4	8	333
	NH measurement module for NH fuse-switch disconnectors, size 3	9343.370	4	8	333

Accessories:

- CAN bus connection cable, see page 818

CMC III access

The secure solution

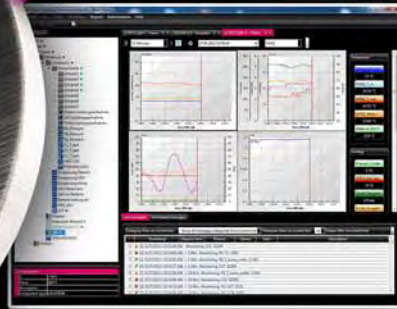

RiZone

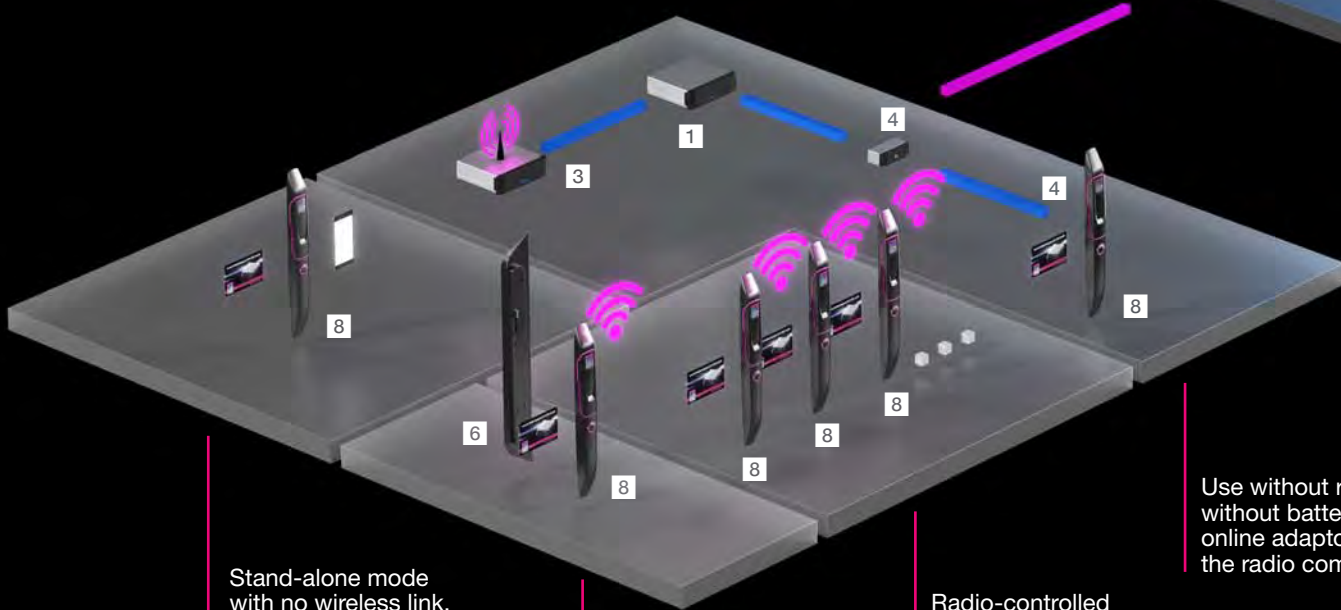

Stand-alone mode with no wireless link, with card administration via the app

Radio comfort handle compatible with TS racks via mounting adaptor

Radio-controlled mode with up to 128 handles

Use without radio link/without battery: use the online adaptor to connect the radio comfort handle



CMC III Processing Unit, see page 803



CMC III Processing Unit Compact, see page 802



CMC III Wireless Unit for radio comfort handle VX, see page 815



CMC III access control, see page 812



Online adaptor, see page 948



Distributed edge application
for individual racks

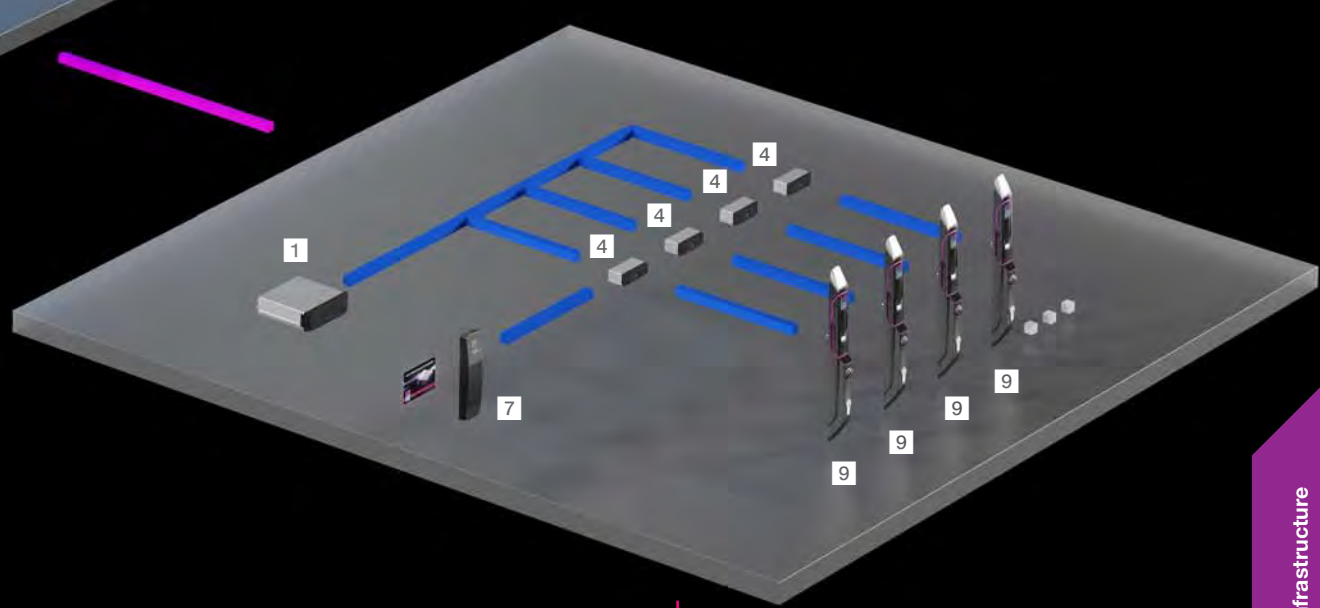
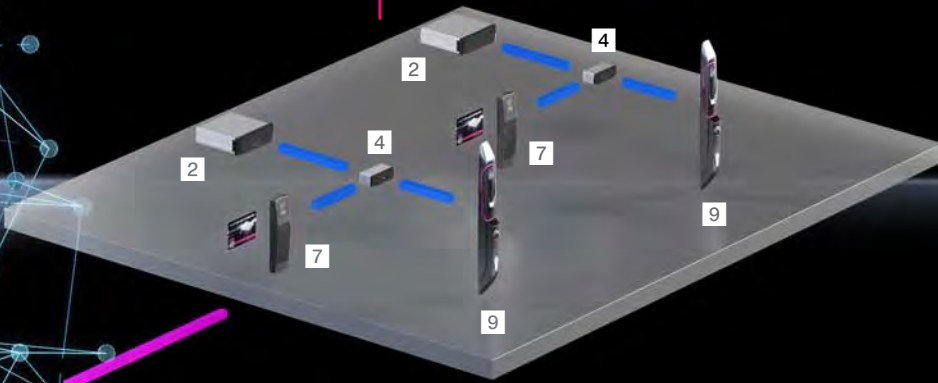

Transponder reader:
Activate up to 16 handles

IT infrastructure



6
Mounting adaptor,
see page 948



7
Transponder reader
for CMC III,
see page 813



8
Radio comfort handle VX
with card reader for VX,
VX IT, see page 947



9
CMC III online comfort
handle VX with master
key function for VX,
VX IT, see page 946

CMC III access

System components



CMC III access control

CMC III unit for controlling and monitoring access to enclosures. One handle and one reader unit may be connected to one CMC III access control. The handles can be linked to various numerical codes or transponder cards via the CMC III Processing Unit/Compact website, which means that all the handles connected to a CMC III Processing Unit/Compact can be controlled with just one reader unit. The integral infrared sensor also ensures that the status of the controlled door (open/closed) is monitored.

Dimensions:

- W x H x D:
110 x 30 x 40 mm

Sample applications:

- Record of every access and each time the door is opened, with user information and time stamp
- One central reader unit per CMC III system is supported
- Fixed allocation between handles and reader units
- Four-eyes principle
- Central administration of access rights across systems and locations with RiZone
- Activating the LED display in the handle

Material:

- Plastic

Surface finish:

- Front: Smooth
- Enclosure: Textured

Colour:

- Front: RAL 9005
- Enclosure: RAL 7035

Protection category IP to IEC 60 529:

- IP 30

Supply includes:

- CMC III access control
- Mounting plate
- Assembly parts



Also required:

- CAN bus connection cable, see page 818

	Connection	Inputs		Outputs		Model No.	PU Compact	PU	Page
	1	2	3	4	5				
	RJ45 2 x CAN bus	RJ12	Flat-pin connector	RJ12	Flat-pin connector	Packs of 1	Maximum quantity		
<p>1 CMC III access control - For connecting one handle and one reader unit to monitor a door - Integral IR access sensor</p>	■	1 x	1 x	-	-	7030.202	2	16 ¹⁾	
Connectable handles and reader units (max. 1 handle and max. 1 reader unit per CMC access control)									
<p>2 Handles - CMC III online comfort handle VX RAL 9005 - Ergoform-S handle (electromagnetic, for TE 8000) RAL 7035</p>	-	-	-	1 x	-	7030.611	-	-	946
	-	-	-	1 x	-	7320.700	-	-	949
<p>3 CMC III reader units - Coded lock RAL 9005 - Transponder reader RAL 9005</p>	-	-	-	-	1 x	7030.223	-	-	813
	-	-	-	-	1 x	7030.233	-	-	813

¹⁾ Max. 5 pieces for power supply with PoE

CMC III access

System components

Coded lock

for CMC III

For managing access to doors.

Benefits:

- Individual codes with up to 8 digits
- Use of a read system for multiple handles is supported, provided this is connected to the same CMC III system
- High security standards thanks to the four-eyes principle

Installation options:

- On VX IT doors
- Adjacent to room doors

Functional principle:

- Direct connection to the CMC III Access Control or CMC III Door Control Module
- Optical (LED) and acoustic (alarm sound) status display
- Authorisations are managed via the CMC III system or RiZone
- Door opening with a maximum of two linked numerical codes (four-eyes principle)
- Control via CMC III of:
 - Online comfort handle VX
 - Automatic Door Opening System (vent flaps)
 - Relay outputs from the CMC III

Packs of	Model No.
1 pc(s).	7030.223

Dimensions:

- W x H x D: 50 x 190 x 25 mm door-mounted

Material:

- Plastic

Colour:

- RAL 9005

Protection category IP to IEC 60 529:

- IP 40

Supply includes:

- Coded lock
- Connection cable 2.9 m
- Adaptor for glazed aluminium door for VX IT
- Assembly parts



Also required:

- CMC III access control, see page 812
- CMC III Processing Unit/Compact, see page 804



Accessories:

- CMC III online comfort handle VX, see page 946
- Door control module, see page 817



Transponder reader

for CMC III

For managing access to doors.

Benefits:

- Use of a read system for multiple handles is supported, provided this is connected to the same CMC III system
- High security standards thanks to the four-eyes principle

Installation options:

- On VX IT doors
- Adjacent to room doors

Functional principle:

- Direct connection to the CMC III Access Control or CMC III Door Control Module
- Optical (LED) and acoustic (alarm sound) status display
- Authorisations are managed via the CMC III system or RiZone
- Door opening with a maximum of two linked transponder cards (four-eyes principle)
- Control via CMC III of:
 - Online comfort handle VX
 - Automatic Door Opening System (vent flaps)
 - Relay outputs from the CMC III

Dimensions:

- W x H x D: 50 x 190 x 25 mm door-mounted

Material:

- Plastic

Colour:

- RAL 9005

Protection category IP to IEC 60 529:

- IP 40

Supply includes:

- Transponder reader
- Connection cable 2.9 m
- Adaptor for glazed aluminium door for VX IT
- Mifare classic transponder card
- Assembly parts



Also required:

- CMC III access control, see page 812
- CMC III Processing Unit/Compact, see page 804



Accessories:

- Transponder card, see page 814
- Door control module, see page 817
- CMC III online comfort handle VX, see page 946



Design	Frequency	Packs of	Model No.
Transponder reader for Mifare, Legic Advant, HID, FeliCa (Legic Prime available on request)	RFID - 13.56 MHz	1 pc(s).	7030.233

CMC III access

System components



Transponder card

Mifare classic

Contactless smart card for opening doors.

Benefits:

- Personalised authentication with history is supported in conjunction with the CMC III system

Applications:

- For use with the CMC III transponder reader or the CMC III radio comfort handle VX with integral card reader

Dimensions:

- W x H x D: 85 x 54 x 1 mm

Transponder card	Packs of	Model No.
Mifare classic	2 pc(s).	7030.628



Also required:

- CMC III transponder reader, see page 813
- CMC III radio comfort handle VX, see page 947



CMC III online comfort handle VX

with master key function for VX, VX IT

For door locking, handle lever monitoring and status display.

Further ordering information may be found in the chapter on system accessories, page 946

Packs of	Model No.
1 pc(s).	7030.611

CMC III access

System components

CMC III Wireless Unit

for radio comfort handle VX

Up to 16 radio comfort handles VX and/or defined EnOcean sensors may be connected via the Wireless Unit. In complex environments with high levels of interference, additional CMC III Wireless Units may be used at alternative locations. This allows the wireless comfort handles/sensors to send their signal to multiple Wireless Units and facilitate redundancy. The Wireless Units can also be placed in multiple separate rooms/units in order to interlink the existing radio handles and sensors. The maximum overall length of the CAN bus route is 50 m/ bus. The unit is compatible with the CMC III Processing Unit.

Benefits:

- High standard of security thanks to encrypted radio transmission of security-relevant signals
- Redundant transmission with up to 16 Wireless Units

Dimensions:

- W x H x D:
138 x 40 (1 U) x 120 + 12 mm front assembly

Material:

- Plastic

Colour:

- Front: RAL 9005
- Enclosure: RAL 7035

Protection category IP to IEC 60 529:

- IP 30

Supply includes:

- Basic system
- Aerial with magnetic base, 2.5 m connection cable
- Assembly parts for mounting on surfaces

Radio technology	Packs of	Model No.
EnOcean, 868 MHz	1 pc(s).	7030.690

Max. no. of wireless units/radio comfort handles/ EnOcean sensors

	Wireless Unit	Processing Unit	Processing Unit Compact
Wireless Unit	-	16	-
Radio comfort handle/ EnOcean sensor	16	128	-

Note:

- More information on the compatibility of other EnOcean sensors can be found at www.rittal.de under Model No. 7030.690.



Also required:

- CAN bus connection cable, see page 818
- CMC III Processing Unit, see page 804
- Mounting unit, 1 U, see page 819
- Radio comfort handle VX, see page 947



Radio comfort handle VX

with card reader for VX, VX IT

Battery-operated radio handle for door locking, handle lever/rack door monitoring and status display.

Further ordering information may be found in the chapter on system accessories, page 947

Packs of	Model No.
1 pc(s).	7030.621



CMC III Automatic Door Opening (ADO)



CMC III Automatic Door Opening (ADO)

For automatic cooling of closed network/server racks in an emergency situation.

The ADO system is comprised of:

- Door control module
- Glazed door VX IT for ADO with integral vent flaps

Applications:

- Overtemperature in the closed VX IT rack
- Extinguisher gas should be able to enter the rack from the room

Activated via the Door Control Module (DCM) unit. One DCM activates one rack with 2 doors (front/rear door). The vent flaps integrated into the glazed door VX IT for ADO are kept closed by a system of magnets, and in an emergency situation are pressed open by the gas pressure damper system. We recommend the use of CMC III and access sensors.

Benefits:

- Stand-alone mode
- Independent power supply
- The integral temperature sensor ensures a high level of reliability, by making it independent from other systems and their power supplies
- The ADO system is not activated for normal access to the rack interior

Note:

The following doors may be connected:

- 2 glazed doors VX IT for ADO with integral vent flaps, Model No. depending on door variant
- For emergency ventilation, we recommend use of the DCM temperature sensor which creates fewer dependencies on other systems and their power supplies for superior reliability.

Activation in case of alarm:

- CMC III task
- DCM, temperature sensor including connection cable
- DCM, digital input

Activation for user access:

- The lock system for manual door access may be selected with standard VX IT doors, see page 919



Also required:

- Door control module DCM, see page 817
- Glazed door VX IT for ADO with integral vent flaps, see page 919



Accessories:

- CMC III Processing Unit/Compact, see page 804
- Combination lock/transponder reader for local function tests, see page 813
- Access sensor, see from page 807

System diagram CMC III Automatic Door Opening (ADO)

- Maximum of 16 door control modules per Processing Unit
- Maximum of 4 door control modules may be connected per Processing Unit Compact

- CMC III
- Processing Unit
 - Processing Unit Compact

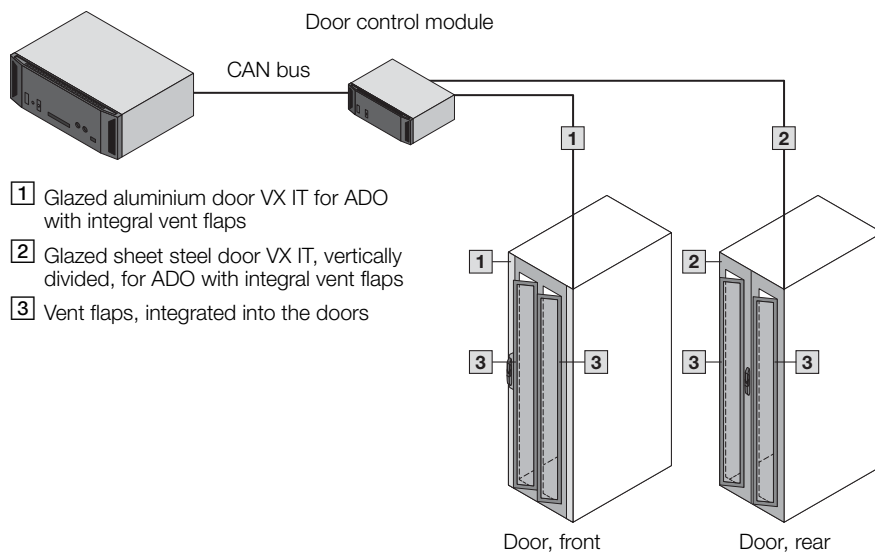

CMC III Automatic Door Opening (ADO)

Door control module

Control unit for automatic opening of glazed doors VX IT for ADO with integral vent flaps. Designed for a rack with front and rear door. To fit CMC III system with CAN bus.

Material:

- Plastic

Colour:

- Front: RAL 9005
- Enclosure: RAL 7035

Supply includes:

- Basic system
- Temperature sensor including connection cable (supplied loose)
- Assembly parts for mounting on surfaces



Also required:

- Glazed doors VX IT for ADO with integral vent flaps, see page 919
- CMC III power pack, see page 818
- Mounting unit, 1 U, see page 819



Accessories:

- Redundant power pack, see page 818
- Coded lock/transponder reader, see page 813
- CMC III Processing Unit/Compact, see page 804
- CAN bus cable, see page 818



Model No.	7030.501
Packs of	1 pc(s).
Maximum no. of PU/PU Compact	16/4
1st rated voltage	24 V (DC) 7030.060 for door control module and glazed doors VX IT for ADO, redundant to 2nd rated voltage
2nd rated voltage	24 V (DC) 7030.060 for door control module and glazed doors VX IT for ADO
1 x temperature sensor input	Temperature sensor including connection cable (supplied loose)
3 x digital inputs	Alarm/front door flaps/rear door flaps
1 x input for reader units	Combination lock/transponder reader for local function testing of the vent flaps
2 x outputs for glazed doors VX IT for ADO with integral vent flaps	Magnet system with damper integrated into the door
2 x CAN bus CMC III	RJ45 for CAN bus cable

Glazed door VX IT

for Automatic Door Opening (ADO)

The doors for the Automatic Door Opening System replace the standard doors of the VX IT.

Further ordering information may be found in the chapter on system accessories, page 919

Packs of	Model No.
1 pc(s).	7030.262
1 pc(s).	7030.263
1 pc(s).	7030.272
1 pc(s).	7030.273
1 pc(s).	7030.282
1 pc(s).	7030.283



CMC III

Accessories



CMC III power pack for PU, PU Compact, LED light strip, door control module

The power pack is specifically tailored to the CMC III design and may be positioned in a mounting unit. As well as a special connector for the CMC III Processing Unit/Compact, there are also two further terminals available as 24 V outputs.

Technical specifications:

- Input voltage: 100 – 240 V / 50/60 Hz
- Output voltage: 24 V (DC)/2.5 A
- Length of 24 V (DC) connection cable: 0.6 m
- Input: IEC 320 connector C14

Dimensions:

- W x H x D:
138 x 40 x 120 + 12 mm front frame

Material:

- Plastic

Surface finish:

- Front: Smooth
- Enclosure: Textured

Colour:

- Front: RAL 9005
- Enclosure: RAL 7035

Supply includes:

- Assembly parts for mounting on surfaces

Packs of	Model No.
1 pc(s).	7030.060



Also required:

- Connection cable, see page 819
- Mounting unit, 1 U, see page 819



Programming cable

For first-time commissioning of the Processing Unit (PU) or PU Compact. During initial start-up, the programming cable connects the CMC III Processing Unit/Compact to the USB interface of a PC. A driver for Windows systems is also included with the supply and must be installed on the PC.

Supply includes:

- CD with driver and system description

Packs of	Model No.
1 pc(s).	7030.080



CAN bus connection cable

For connecting the PU to the CAN bus sensors III, units III and control units III as a bus, also for cabling together.

Because it is available in different lengths, the CMC III system can be adapted to various applications and built to a custom design.

CMC III CAN bus connection cable	Length m	Packs of	Model No.
RJ45	0.5	1 pc(s).	7030.090
RJ45	1	1 pc(s).	7030.091
RJ45	1.5	1 pc(s).	7030.092
RJ45	2	1 pc(s).	7030.093
RJ45	3	1 pc(s).	7030.480
RJ45	4	1 pc(s).	7030.490
RJ45	5	1 pc(s).	7030.094
RJ45	10	1 pc(s).	7030.095

Connection cable/extension

For connecting to:

- CMC III power pack C14
- CMC III power unit C13/C14
- PDU C19

Technical specifications:

- PVC cable, 3-pole, with IEC 60 320 cable coupling (non-heating appliances) with contact protection CEE22
- Length: Minimum 1.8 m

Country version	Voltage (V)	Packs of	Model No.
D/F/B/C13	230	1 pc(s).	7200.210
IEC 320 device extension C13/C14	230/115	1 pc(s).	7200.215
Connection cable D/C19	230/115	1 pc(s).	7200.216
Connection cable C19/C20	230/115	1 pc(s).	7200.217



Connection/extension cable RJ12

with RJ12 connector/jack

To extend cable connections to CMC-TC sensors and CMC III online comfort handle VX and to connect the CMC III access sensor 7030.128, either individually or in a row of sensors.

Length m	Packs of	Model No.
1	2 pc(s).	7320.814



Mounting unit, 1 U

For installing CMC III units in network and server racks. To accommodate up to three CMC III enclosures and for mounting in the 482.6 mm (19") section.

To accommodate:

- CMC III Processing Unit
- CMC III Processing Unit Compact
- CMC III control unit
- CMC III Wireless Unit
- CMC III power pack
- CMC III LTE unit
- CMC III door control module

Benefits:

- Fire protection: Self-extinguishing to UL 94-HB

Packs of	Model No.
1 pc(s).	7030.088

Material:

- Plastic

Colour:

- RAL 9005

Supply includes:

- Mounting unit, 1 U
- 2 blanking covers
- Assembly parts



Accessories:

- Cable clamp strap 7030.087, see page 819

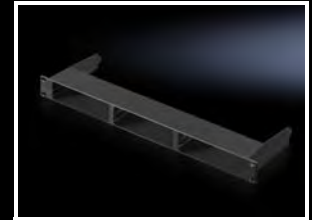

Cable clamp strap

For tool-free attachment to the rear of the CMC III 482.6 mm (19") mounting unit 7030.088. Enables tidy cable routing behind the built-in CMC III devices and can be used to attach cables for strain relief purposes. Cables are easily laid in a loop to allow the built-in CMC III devices to be removed from the mounting unit without the need for tools.

Applications:

- Cable management

Benefits:

- Cable support
- Fire protection: Self-extinguishing to UL 94-HB

Packs of	Model No.
1 pc(s).	7030.087

Material:

- Plastic

Colour:

- RAL 9005

Supply includes:

- Assembly parts

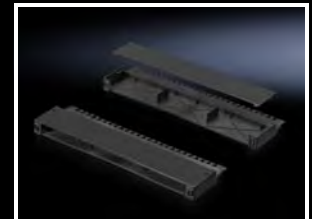

CMC III

Accessories



Mounting unit

To accommodate one CMC III unit and for mounting on the enclosure frame.

To accommodate:

- CMC III Processing Unit
- CMC III Processing Unit Compact
- CMC III Control unit
- CMC III Wireless Unit
- CMC III Power pack
- CMC III LTE unit
- CMC III Door control module

Material:

- Sheet steel

Surface finish:

- Zinc-plated

Supply includes:

- Assembly parts

Packs of	Model No.
1 pc(s).	7030.071



CMC III LTE unit

For configuring a redundant transmission channel or, if there is no network infrastructure available, for alarm forwarding. The alarm signal is designed in text message format. Cover for LTE (4G), UMTS (3G) and GSM (2G) with automatic changeover function, see bands and frequencies. A standard, commercially available SIM card must be provided by the customer.

Material:

- Plastic

Colour:

- Front: RAL 9005
- Enclosure: RAL 7035

Supply includes:

- CMC III LTE unit
- RJ12 cable
- Aerial including magnetic base
- Assembly parts for mounting on surfaces

Packs of	Model No.
1 pc(s).	7030.571

Network support / bands and frequencies:

- 4G LTE band 1 (2100 MHz)
- 4G LTE band 3 (1800 MHz)
- 4G LTE band 8 (900 MHz)
- 4G LTE band 20 (800 MHz)
- 4G LTE band 28 (700 MHz)
- 3G UMTS band 1 (2100 MHz)
- 3G UMTS band 8 (900 MHz)
- 2G GSM (900 MHz)
- 2G GSM (1800 MHz)

**Also required:**

- CMC III Processing Unit/Compact, see page 804
- Mounting unit, 1 U, see page 819

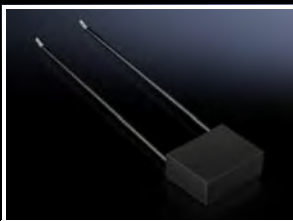

Interference suppressor for fans

for CMC III

For connecting fans via the CMC III power unit 7030.050. The interference suppressor prevents excessive breaking currents. One interference suppressor is required for each fan.

Material:

- Plastic

Colour:

- RAL 9005

Supply includes:

- Assembly parts

Packs of	Model No.
1 pc(s).	7030.051

LED light strip

for CMC III

For colour status display within a network/server rack. If an error occurs, the light strip will change to the set colour.

Benefits:

- Stand-alone mode by connecting the RGB LED light strip directly to a 24 V (DC) power pack
- Easy to install with the integral magnetic attachment

Functional principle:

- Activation via CMC III
- Connection via three of the four relay connections on the CMC III I/O unit
- Connection via the alarm relay of the Processing Unit/Compact with colour change
- Connects directly to the CMC III power pack
- The three connection cables of the LED light strip activate the three basic colours red, green and blue. Activating two or three colours simultaneously will create the corresponding secondary colours. Links to sensor warnings or alarms are made via task links in the CMC III system.

Technical specifications:

- Rated voltage: 24 V (DC)
- Rated current: 1.1 A

Dimensions:

- W x H x D: 18 x 1830 x 24.2 mm

Material:

- Aluminium
- Plastic

Supply includes:

- LED light strip including magnetic attachment
- Connection cable 0.1 m
- Connection cable 2.4 m with four pre-assembled connectors for the CMC III I/O unit

Packs of	Model No.
1 pc(s).	7030.950



Also required:

- CMC III power pack, see page 818



Accessories:

- CMC III I/O unit, see page 806
- CMC III Processing Unit/Compact, see page 804

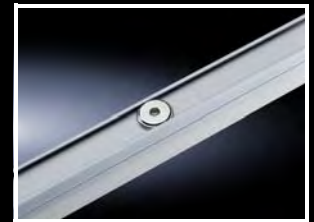
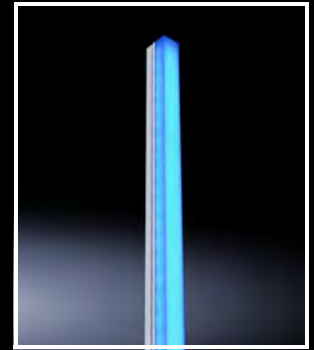

Monitor/keyboard unit



Monitor/keyboard unit, 1 U

with 17" TFT display and VGA/DVI connection

The unit is housed in a pull-out drawer. The monitor can be flipped up and the drawer latches into the end position. This means that the unit only requires 1 U in the 482.6 mm (19") rack.

Benefits:

- With digital and analog interfaces, VGA, DVI-D, PS/2, USB
- Simple one-person assembly

Main components:

- TFT monitor 17"
- Keyboard, German or English
- Touchpad

Supply includes:

- Monitor/keyboard unit
- VGA cable
- DVI cable
- 2 x PS/2 cable
- USB cable
- Earthing-pin mains cable
- Assembly parts

Technical design:

- 432 mm/17" TFT display
- Physical resolution: 1280 x 1024
- Format: 4 : 3
- Colours: 16.7 million colours
- Brightness approx. 350 cd/m² (typ.)
- Contrast ratio: approx. 1000 : 1
- Mains voltage: 100 – 240 V / 50/60 Hz
- Ambient temperature: +5 °C...+45 °C (operation)
- Max. power consumption in operation: 32 W
- Max. power consumption with closed monitor unit: < 1 W
- Rear connections: Mains voltage, VGA, DVI, PS/2, USB
- Lockable at the front
- Cables are safely routed in the energy chain

Width	Height U	Depth mm	Installation depth mm	Colour	Keyboard	Packs of	Model No.
482.6 mm/ 19"	1	680	680 – 850	RAL 7035	German	1 pc(s).	9055.310
					US English	1 pc(s).	9055.312
				RAL 9005	German	1 pc(s).	9055.410
					US English	1 pc(s).	9055.412

Fire alarm and extinguisher system



System accessories Page 877 Network/server racks VX IT Page 686 Micro Data Center Page 842

The active extinguisher system includes the smoke extraction system and the extinguisher unit. The smoke extraction system is identical to the smoke extraction system in the EFD III. The extinguishing process begins automatically when a main alarm is activated. For the extinguishing process, the tank is pressurised via a propellant cartridge. The extinguisher gas Novec™ 1230 evaporates at the extinguisher nozzle and is distributed in the server enclosure.

Benefits:

- Early fire detection
- Automatic extinguishing
- Innovative extinguisher Novec™ 1230: eco-friendly, non-critical for IT components, non-conductive
- 482.6 mm (19") rack mount with just 1 U
- Tested by VdS Schadenverhütung GmbH
- CAN bus interface to the CMC III monitoring system
- Floating relay outputs (pre-alarm/main alarm/collective fault)

Material:

- Sheet steel

Colour:

- Enclosure: RAL 7035
- Front: RAL 9005

Protection category IP to IEC 60 529:

- IP 30

Note:

- This system is designed solely for use in closed, non-accessible enclosure systems with a maximum volume of 2.8 m³.

DET-AC III master

Width mm	Packs of	482.6	Page
Height mm		44	
Depth mm		660	
Weight kg		21.5	
Model No.	1 pc(s).	7338.121	
Operating temperature range		+10 °C...+40 °C	
Storage temperature range without batteries		-20 °C...+65 °C	
Storage temperature range of batteries		-15 °C...+40 °C	
Ambient humidity (non-condensing) %		96	
Rated operating voltage V, ~, Hz		100 - 240, 1~, 50/60	
Emergency power supply		approx. 4 h	
Airflow monitoring		approx. ±10% of total airflow	
Interfaces		4 x/3 x relay outputs for alarms and faults (terminals/RJ12 jacks) 1 x/1 x input for door contact switch (terminal/RJ12 jack) 2 x CAN connections for master-slave networking 2 x connection (external alarm/manual triggering device) 1 x voltage output for DET-AC slave III (24 V DC max. 500 mA) 1 x USB 2 x CAN bus interfaces to CMC III (max. 16 on PU/4 on PU Compact)	
Sensors		Optical smoke detector (sensitivity: approx. 3.5%/m light obscuration) Optical smoke detector HS (sensitivity: approx. 0.25%/m light obscuration)	
Display		Plain-language display with 6 LEDs	
Technical specifications		Extinguisher is emitted via a propellant cartridge, with integral electrical activation unit Integral extinguisher monitoring (indication of >15% loss)	
Tank: Material/volume l		Aluminium / 2	
Extinguisher: Type/fill volume l		Novec™ 1230 / 1.8	

Also required			
CMC III access sensor VX	1 pc(s).	7030.128	808
CMC III CAN bus connection cable	1 pc(s).	7030.091	818
Sealing kit for VX IT and LCP	1 pc(s).	7338.135	826
Pipe kit	1 pc(s).	7338.130	826
Slide rail, 1 U, depth-variable	2 pc(s).	5302.035	1088

Early fire detection system



System accessories Page 877 Network/server racks VX IT Page 686 Micro Data Center Page 842

The EFD III early fire detection system includes the smoke extraction system in a 482.6 mm (19") subrack with just 1 U. An integral fan continuously extracts air from the area being protected via a system of pipes. The air drawn in passes two fire detectors. If smoke is detected, the highly sensitive detector will emit a pre-alarm, while the second detector will activate the main alarm. The fire detectors are permanently monitored for correct functioning by the evaluation and control electronics on the control card.

Benefits:

- Early fire detection
- 482.6 mm (19") rack mount with just 1 U
- Tested by VdS Schadenverhütung GmbH
- CAN bus interface to the CMC III monitoring system
- Floating relay outputs (pre-alarm/main alarm/collective fault)

Material:

- Sheet steel

Colour:

- Enclosure: RAL 7035
- Front: RAL 9005

Protection category IP to IEC 60 529:

- IP 30

Note:

- This system is designed solely for use in closed, non-accessible enclosure systems.

EFD III

Width mm	Packs of	482.6	Page
Height mm		44	
Depth mm		490	
Weight kg		15.0	
Model No.	1 pc(s).	7338.221	
Operating temperature range		+10 °C...+40 °C	
Storage temperature range without batteries		-20 °C...+65 °C	
Storage temperature range of batteries		-15 °C...+40 °C	
Ambient humidity (non-condensing) %		96	
Rated operating voltage V, ~, Hz		100 - 240, 1~, 50/60	
Emergency power supply		approx. 4 h	
Airflow monitoring		approx. ±10% of total airflow	
Interfaces		4 x/3 x relay outputs for alarms and faults (terminals/RJ12 jacks) 1 x/1 x input for door contact switch (terminal/RJ12 jack) 2 x CAN connections for master-slave networking 3 x connection (external alarm/manual call point/tank and fill level) 1 x voltage output for DET-AC slave III (24 V DC max. 500 mA) 1 x USB 2 x CAN bus interfaces to CMC III (max. 16 on PU/4 on PU Compact)	
Sensors		Optical smoke detector (sensitivity: approx. 3.5%/m light obscuration) Optical smoke detector HS (sensitivity: approx. 0.25%/m light obscuration)	
Display		Plain-language display with 6 LEDs	
Also required			
CMC III CAN bus connection cable	1 pc(s).	7030.091	818
Pipe kit	1 pc(s).	7338.130	826
Slide rail, 1 U, depth-variable	2 pc(s).	5302.035	1088



System accessories Page 877 **Network/server racks VX IT** Page 686 **Micro Data Center** Page 842

This add-on unit to the DET AC III Master includes an additional extinguisher unit. In addition to the DET-AC III unit, a DET-AC III slave unit is used for each additional bayed enclosure and supplies the extinguishing agent for that enclosure. Detection occurs via the DET-AC III master system, even when multiple enclosures are bayed together. If a main alarm is reported, the DET-AC III Master will activate extinguishing in all systems simultaneously.

Benefits:

- Innovative extinguisher Novec™ 1230: eco-friendly, non-critical for IT components, non-conductive
- 482.6 mm (19") rack mount with just 1 U
- Tested by VdS Schadenverhütung GmbH
- CAN bus interface to the CMC III monitoring system
- In conjunction with the DET-AC III Master, extinguishes up to five racks in an enclosure suite
- May be used in combination with EFD III
- Floating relay outputs (pre-alarm/main alarm/collective fault)

Material:

- Sheet steel

Colour:

- Enclosure: RAL 7035
- Front: RAL 9005

Protection category IP to IEC 60 529:

- IP 30

Note:

- This system is designed solely for use in closed, non-accessible enclosure systems with a maximum volume of 2.8 m³.

DET-AC III slave

Width mm	Packs of	482.6	Page
Height mm		44	
Depth mm		660	
Weight kg		19.1	
Model No.	1 pc(s).	7338.321	
Operating temperature range		+10 °C...+40 °C	
Storage temperature range without batteries		-20 °C...+65 °C	
Storage temperature range of batteries		-15 °C...+40 °C	
Ambient humidity (non-condensing) %		96	
Rated operating voltage V		24 (DC)	
Emergency power supply		approx. 4 h	
Interfaces		4 x/3 x relay outputs for alarms and faults (terminals/RJ12 jacks) 1 x/1 x input for door contact switch (terminal/RJ12 jack) 2 x CAN connections for master-slave networking 2 x connection (external alarm/manual triggering device) 1 x voltage output for DET-AC slave III (24 V DC max. 500 mA) 1 x USB 2 x CAN bus interfaces to CMC III (max. 16 on PU/4 on PU Compact)	
Technical specifications		Extinguisher is emitted via a propellant cartridge, with integral electrical activation unit Integral extinguisher monitoring (indication of >15% loss)	
Tank: Material/volume l		Aluminium / 2	
Extinguisher: Type/fill volume l		Novec™ 1230 / 1.8	

Also required			
CMC III access sensor VX	1 pc(s).	7030.128	808
Sealing kit for VX IT and LCP	1 pc(s).	7338.135	826
Pipe kit	1 pc(s).	7338.130	826
Slide rail, 1 U, depth-variable	2 pc(s).	5302.035	1088

Fire alarm and extinguisher system

Accessories



Pipe kit

for DET-AC III/EFD III

Non-adhesive plug-in system for connecting to the DET-AC III fire alarm and extinguisher system and the EFD III early fire detection system.

Functions:

- The system fans continuously draw air out of the protected area via this pipe system.

Technical specifications:

- Diameter of plastic pipe: 18 mm internal, 22 mm external

Colour:

- Black

Supply includes:

- 3 plastic pipes @ 1 m
- T-piece
- 2 connector pieces, straight
- 4 connection brackets, 90°
- 2 end caps
- Assembly parts

Packs of	Model No.
1 pc(s).	7338.130

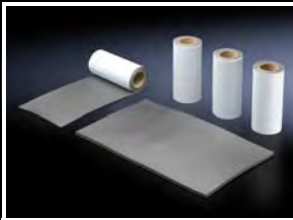

Sealing kit for VX IT and LCP

in conjunction with DET-AC III master/slave

For closing openings in VX IT network/server racks and Liquid Cooling Packages when using a DET-AC III fire alarm and extinguisher system.

Applications:

- Closes the brush strips in two roof plates of the VX IT rack
- Closes 1 brush strip in the roof plate of the LCP
- Closes the opening in the base of the LCP CW/LCP DX in the vicinity of the refrigerant/water lines

Benefits:

- Sealing of cable, hose and pipe glands in the roof and base section without impairing their function

Material:

- Polythene foam, self-adhesive on one side

Colour:

- Anthracite

Supply includes:

- 4 blanks to fit two VX IT roof plates
- 1 blank for an LCP

Packs of	Model No.
1 pc(s).	7338.135

IT Infrastructure Selector

All data centre product categories at a glance



Use it online at
www.rittal.com/it-configurator

IT infrastructure

RiZone

Data centre infrastructure management – RiZone

RiZone is Rittal's DCIM solution for easy, efficient monitoring and control of a data centre's physical infrastructure. It is designed to help improve the availability and efficiency of the data centre. The high availability demands of data centre users necessitates a comprehensive security management system. This relies on the monitoring of all data centre components and parameters with relevance to security and availability. RiZone is tasked with implementing all messages, sensor values and actuators in the IT infrastructure and server environment into a plausible message chain to ensure transparent operation of the data centre. The formulaic correlation in RiZone Editor transforms individual warnings, data or signals into logical information and actions, to maintain the data centre's availability.

RiZone – Optimum monitoring of IT infrastructure components

- Incorporation of the physical IT infrastructure
- Automatic detection of Rittal components
- Simple configuration of power distribution systems
- Workflow editor for user-defined scenarios
- Enhanced security and reliability
- Improved energy efficiency
- Integration of SNMP-compatible third-party equipment

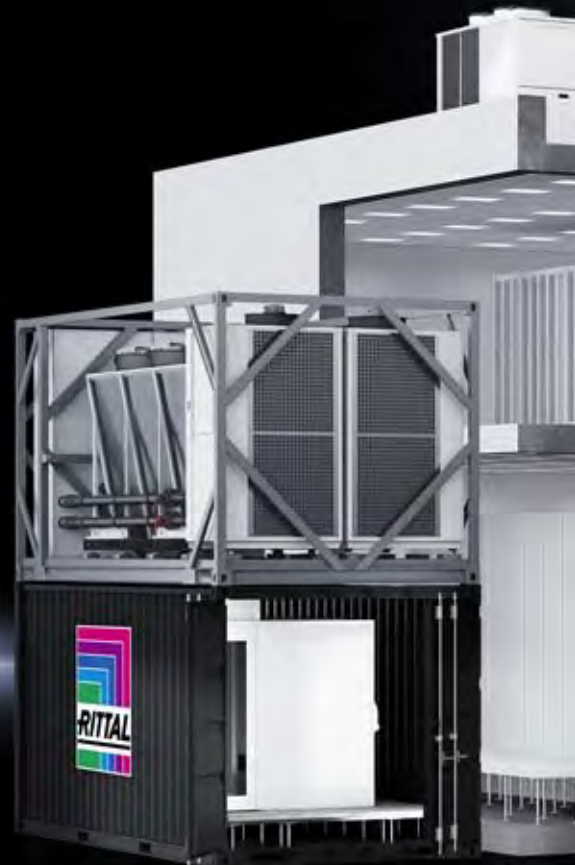

IT infrastructure in context

RiZone is the ideal solution for operating the entire IT infrastructure safely and efficiently. To this end, all processes are viewed in context and all components are perfectly coordinated with one another.



Prevention and reliability

- Identify hot spots in servers early on
- Continuously monitor individual electricity phases, avoid overloads and safeguard availability
- Set optimum climate control parameters

Trends and resource planning

- Identify bottlenecks in the physical supply early on
- Transparently plan extensions to the infrastructure

Functionality and efficiency

- Monitor PUE (power usage effectiveness) values
- Optimise energy efficiency in all areas

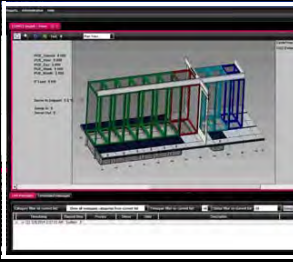

DCIM – Data Centre Infrastructure Management

RiZone – Perfect support of IT infrastructure components

Optional support of Rittal components – from server enclosures to power supply and climate control, through to security and monitoring technology – during integration and in the operational phase, with coordinated sensors and control systems.

- The physical data centre infrastructure (OT devices) is incorporated into a data centre infrastructure management system.
- RiZone supports SNMP V1/V2C and SNMP V3
- Simple configuration
- Automatic detection of Rittal components
- Workflow editor for user-defined scenarios (what happens if ...)
- Enhanced security and reliability thanks to logical representation of the operating concept in RiZone
- Energy optimisation in the data centre
- Integration of SNMP-compatible third-party equipment

■ Autodiscovery

Detection of all SNMP-compatible IT infrastructure components

■ Database

In-house SQL database or link to external MS-SQL and Oracle databases

■ Capacity management

- Monitoring of data centre capacity utilisation
- Redundancy monitoring of the climate control and power supply
- Determination of optimum server installation positions
- Optimisation of capacity utilisation and data centre availability

■ Off-line project planning

- Pre-configuration of RiZone projects
- Supports Rittal CMC III components as well as RiMatrix S
- Components are easily replaced using drag and drop

■ Central access control

- Central administration of access data and PINs
- One-time PIN function
- Emergency PIN function
- 2-way authorisation

■ User administration

- Granular user administration within RiZone
- Support directory services

■ Open Virtualization Format (OVF)

- The virtual RiZone appliance is supplied in the industry standard OVF

■ Active Directory

- The RiZone server may be a member of a directory service
- RiZone users may be a member of a directory service

■ CMC III access control

- Central administration of access control by RiZone
- Administration of transponder cards
- Centralised administration of access data
- Import function

RiZone plus Rittal components creates a system solution with maximum energy efficiency.

Note:

- RiZone Appliance Standard
- RiZone IP node licence
see page 831



Rizone Appliance Standard

RiZone is supplied as a software appliance.

The software appliance is available as a virtual server in Open Virtualization Format (OVF) which is easily used on existing hardware in the data centre.

RiZone installer

- RiZone is installed on a client server
- The software is installed by a Rittal engineer on a Windows server 2012R2 or 2016

Note:

- RiZone supports the protocols SNMP V1/V2C and SNMP V3 for monitoring infrastructure components (OT devices) in a data centre. RiZone is manufacturer-neutral and suitable for use in a heterogeneous landscape of OT devices.
- Available to download at www.rittal.com/software



Also required:

- RiZone IP node licence according to the number of IP nodes available

Standard version	Model No.		
	Hard drive + Windows	RiZone software	RiZone graphics tool
Software appliance ¹⁾	7990.103	7990.203	7990.303
Installer	-	7990.402	7990.502

¹⁾ All Model Nos. on the same line belong together, and must always be ordered together

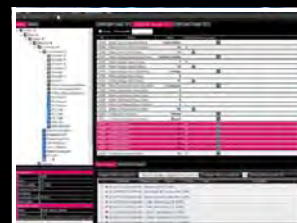

RiZone Appliance IP node licence

The flexible RiZone licence model allows optimum adaptation to any project size, while at the same time being capable of growing with the data centre.

The volume licences for the IP nodes are graduated with 25 and 100 nodes and may be adapted precisely to the size of the data centre. One node licence is required for each active component or other SNMP-compatible component to be covered.

For no. of IP nodes ¹⁾	Console licences included	Model No.	
		RiZone software	RiZone graphics tool
25	4	7990.206	7990.306
100	8	7990.208	7990.308

¹⁾ All Model Nos. on the same line belong together, and must always be ordered together

Note:

- Download available at www.rittal.com/software

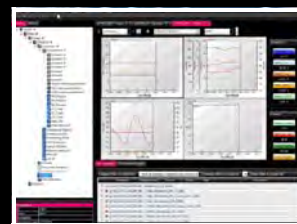

Rittal – The System.

Faster – better – everywhere.

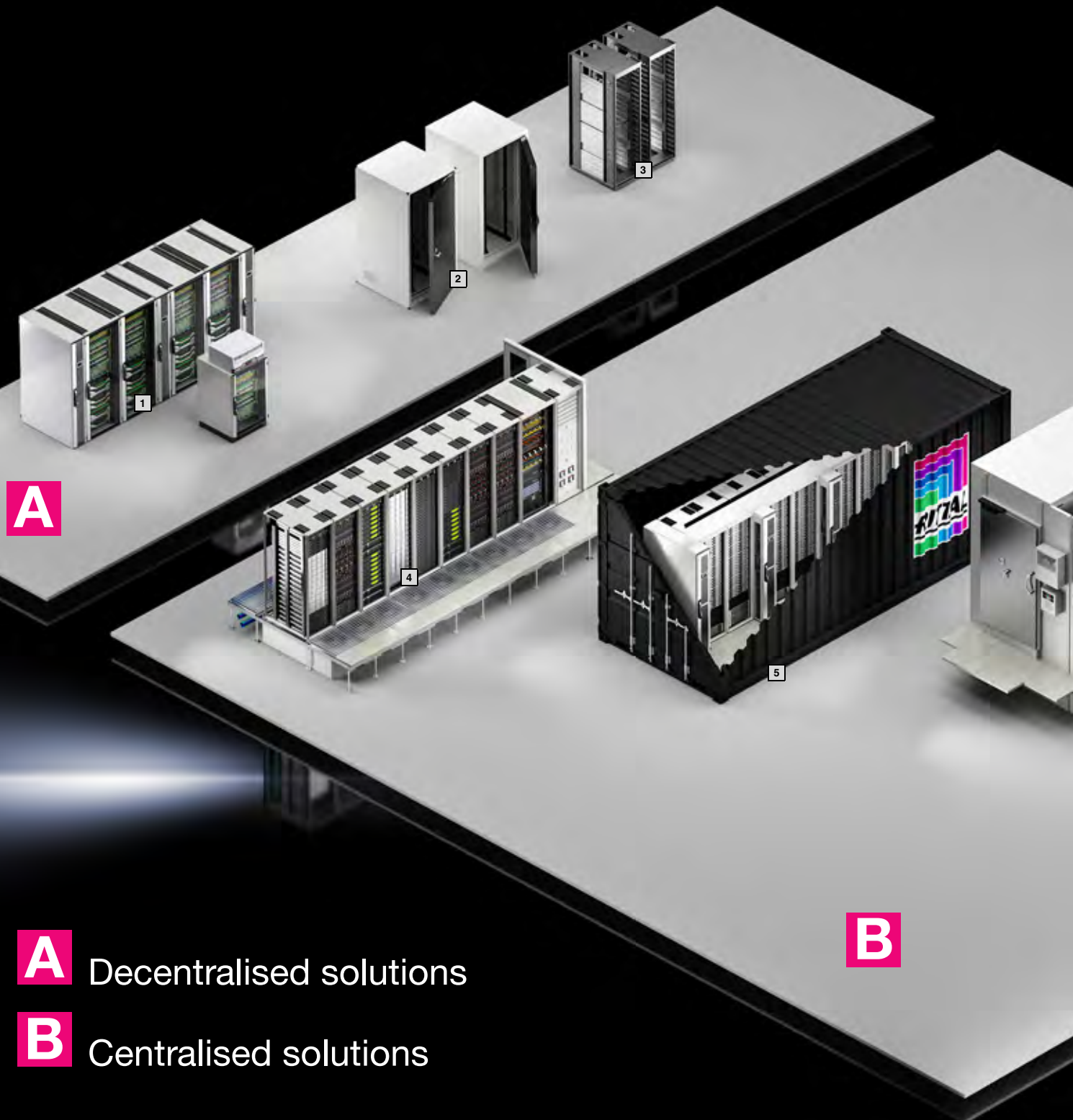

A Decentralised solutions

B Centralised solutions

IT solutions

Edge Data Center

The ideal solution for your applications	834
With efficient plug & play solutions and innovative cooling technology	836
Reliable and redundant with split cooling solutions	838
The modular concept in a security safe or container	840

Micro Data Center

High-availability in a security safe	842
Micro Data Center Level E	844
Micro Data Center Level B	846

RiMatrix S

RiMatrix S – The standardised data centre	848
RiMatrix S at a glance	850

Data centre container

The modular concept for complete IT infrastructures	852
RiMatrix Data Cube	854
RiMatrix Data Cube IT, SME, cloud and edge applications	856
RiMatrix Data Cube All-in-One, SME, cloud and edge applications	860

Security room

High-availability for data centres	862
Basic Protection room and Basic Protection Plus room (GSR)	864
High-Availability room (HVR)	865

Open Compute Project

Open Compute Project (OCP)	866
Rack design for greater flexibility	868
Standard R-OCP V2 rack	870
Accessories	871

Software for IT infrastructure

IT infrastructure selector	874
RiMatrix S selector	874
Micro Data Center configurator	874
PDU configurator	875
IT cooling calculator	875
DCIM – Data Centre Infrastructure Management	875

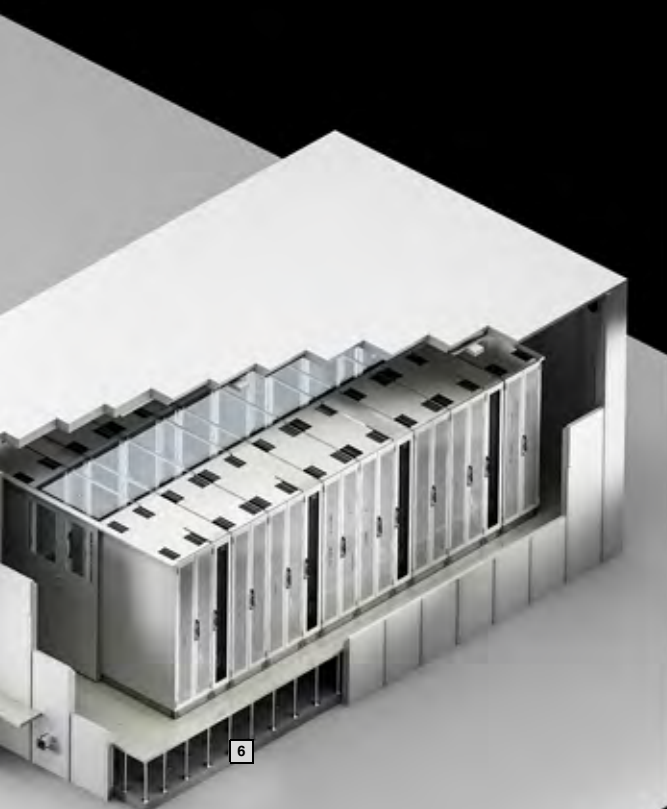

Sample applications

- 1 Edge Data Center, see page 834
- 2 Micro Data Center, see page 842
- 3 Open Compute Project, see page 866
- 4 RiMatrix S, see page 848
- 5 IT container, see page 852
- 6 Security room, see page 862

Edge Data Center

The ideal solution for your applications



Edge & cloud solutions – for successful digitalization

- Industry 4.0, mobile streaming and self-driving cars all demand the fastest response times, top-level security, and availability. Rittal edge solutions deliver just that. They allow you to securely store, process and share large quantities of data in real time, wherever it is needed.
- Edge computing can significantly reduce storage and transmission costs, because large volumes of data can be pre-processed with only relevant data subsequently being transferred to a cloud or IT infrastructure. In this way, an edge data centre ensures minimal latency combined with maximum reliability and security.

Flexibility and reliability

- Edge data centres are always based around the local application. They must offer all the features of a “conventional” data centre, such as security and availability, since the availability of a production line depends on all its components, from the robot through to the edge data centre.
- Redundancy and fail-safe operation are key: The concept of continuous power & cooling ensures that the IT remains available for a defined period of time following a power failure so that the systems can be made safe.
- Fully redundant edge solutions can also be used to protect highly sensitive applications.

Scalability and physical protection

- Edge data centres are found across all industries in a wide range of application scenarios. The ability to adapt flexibly to the current situation is vital, as are standardised modular solutions enabling the fast assembly of large-scale edge topologies.
- Container solutions and outdoor enclosures facilitate siting outdoors, while micro data centres and security rooms provide bespoke protection in buildings when edge data centres must be protected from physical threats. Of course, the physical protective shield can be tailored precisely to keep pace with your growth plans.



Edge Data Center

With efficient plug & play solutions and innovative cooling technology

In industrial operations, building management, the logistics chain and logistics centres, the market for applications with edge data centres is continuously expanding. The emphasis here is on efficiency and reliability. Rittal's innovative cooling units in the Blue e+ series with integral heatpipe herald a new dimension in efficiency, particularly for edge data centres at the lower end of the output range.



Your benefits at a glance:

- Interfaces to all sensors, machines and devices
- Low latency in critical applications
- Capture and analysis of unstructured data to avoid unnecessary transmission to the cloud
- Interface to other edge data centres and to superimposed services in the cloud
- Efficient plug & play cooling solution with no installation work required

Example of a rear door-mounted cooling unit application:

- Cooling of IT equipment with standalone enclosure solutions
- Plug & play cooling solution with no installation work
- Rack-based cooling solution combined with 482.6 mm (19") rack extinguisher systems
- For use in industrial environments

IT Infrastructure	Product description	Packs of	Model No.
IT rack	Network/server enclosure VX IT, IP 55	1	5309.136
IT power	PDU metered, 24 x C13/4 x C19, 1~, 16 A	2	7979.215
IT cooling	Wall-mounted-mounted cooling unit Blue e+ IT, up to 3 kW	1	3312.810
	Air duct for wall-mounted cooling unit Blue e+ IT	1	3312.820
IT monitoring	IoT interface	1	3124.300
	Temperature/humidity sensor	1	7030.111
	Access sensor	2	7030.120
IT security	Fire alarm and extinguisher system DET-AC III	1	7338.121
IT accessories	IT LED system light, 600 lm	1	7859.000

All the variants shown are sample configurations. Individually adaptable.

Example of a roof-mounted cooling unit application:

This edge solution is perfect for production and IoT sensor data capture, and for managing all types of data.

IT Infrastructure	Product description	Packs of	Model No.
IT rack	Network/server enclosure VX IT, IP 55	1	5309.134
IT power	PDU metered, 12 x C13/1 x C19, 1~, 16 A	2	7979.210
IT cooling	Roof-mounted cooling unit Blue e+ IT, 1.6 kW	1	3312.800
	IoT interface	1	3124.300
IT monitoring	Temperature/humidity sensor	1	7030.111
	Access sensor	2	7030.120
IT security	Smoke detector	1	7030.400
IT accessories	IT LED system light, 600 lm	1	7859.000

All the variants shown are sample configurations. Individually adaptable.

Edge Data Center

Reliable and redundant with split cooling solutions

Edge data centres can handle a wide variety of tasks, not just data capture and condition monitoring. With critical processes, such as controlling traffic flows or monitoring production processes, it is particularly vital for an edge data centre to reflect the availability of the application. Scalable redundancy is the key here.



Example of an integrated cooling unit application:

IT infrastructures comprising just one or two IT racks must still offer the same features as a large data centre. This begins with a reliable power supply and cooling, and extends through to monitoring. Smaller edge data centres are ideally suited for distributed installation across various locations for processing data in real time (for example, traffic monitoring and control).

The coolant-based cooling units are designed as split solutions. Depending on the cooling output, the heat exchanger is either built into the server rack or bayed to the server rack. Heat is emitted direct outside of the building.

IT Infrastructure	Product description	Packs of	Model No.
IT rack	Network/server enclosure VX IT, IP 55	2	5309.190
IT power	PDU metered, 24 x C13/4 x C19, 1-, 32 A	4	7979.216
IT cooling	LCU DX, redundant, 6.5 kW	2	3311.493
IT monitoring	CMC III monitoring system	1	7030.000
IT security	Fire alarm and extinguisher system DET-AC III	1	7338.121
IT accessories	IT LED system light, 600 lm	2	7859.000
	CAT 6, Network Cable Organizer	4	7044.110

All the variants shown are sample configurations. Individually adaptable.



Example of a rack-based suite cooling application:

Smart cities, interconnected vehicles and streaming services bring with them the challenge of continuous availability of safety-relevant data. This calls for data centres with a maximum degree of fail-safeness. Edge data centres are the answer, being exceptionally energy-efficient with a small footprint.

IT Infrastructure	Product description	Packs of	Model No.
IT rack	Network/server rack VX IT, IP 55	4	5309.136
IT power	PDU metered, 24 x C13/6 x C19, 3-, 16 A	8	7979.236
IT cooling	LCP Rack DX, 12 kW	3	3313.420
	Condenser unit for LCP DX	3	3311.360
IT monitoring	CMC III monitoring system	1	7030.000
	Automatic door opening (ADO)	1	7030.262
	Access sensor	2	7030.120
IT security	Fire alarm and extinguisher system DET-AC III	1	7338.121
	Add-on unit DET-AC III	3	7338.321
IT accessories	IT LED system light, 600 lm	1	7859.000

All the variants shown are sample configurations. Individually adaptable.

Edge Data Center

The modular concept in a security safe or container

Data such as personal patient data is highly sensitive and must be protected from theft, while production data must be protected from physical threats such as dust, fire and splashed water. The Micro Data Center provides the perfect housing for edge data centres. The numerous options available, coupled with the opportunity of buying, permit a high degree of flexibility at the point of use.



Continuously growing data volumes are having a major impact on IT infrastructure. Demand for CPU and storage capacity is increasing at the same pace, which means that more and more servers and storage systems are needed, while the floorspace available for IT infrastructure has barely changed. Rittal's data centres in containers offer the perfect solution, because the standardised RiMatrix Data Cubes are installed in a short time and the concept is individually tailored to your requirements.

Benefits of Rittal container solutions:

- Customised container solutions on a platform basis
- Predefined modules are individually compiled to create a container data centre
- Pre-assembled container solutions can be up and running in next to no time.
- Project planning by Rittal
- Turnkey delivery of a field-tested solution complete with comprehensive documentation.

If there is no suitable space available in the office building, factory hall or institution, it may be possible to site the edge data centre outdoors. The modular container from Rittal is the ideal platform for combining predefined solutions of server, power and cooling containers. Numerous options and a choice of redundancy classes mean that solutions are precisely aligned with customer requirements.

Application examples for Rittal container solutions:

- Lack of space, because more IT hardware is needed as data volumes grow
- Influence of IoT and Industry 4.0: Data exchange between the machines and data centre must be guaranteed
- With edge data centres, the computing performance is provided locally, data volumes are reduced, and pressure on the main company data centre is relieved

IT Infrastructure	Product description	Packs of	Model No.
Container	RiMatrix Data Center Container all-in-one, max. IT output 35 kW	1	RDC-AIO 35/3-M-II
IT rack	Server rack	3	5310.009
	Network rack	1	5311.009
IT power	Low voltage distribution	1	7857.009
	UPS, modular, 40 + 20 kW	1	DPA UPScale ST TS 8
	PDU metered, 24 x C13/6 x C19, 3~, 16 A	4 x 2	7979.236
IT cooling	LCP Inline DX, 12 kW	5	3313.430

All the variants shown are sample configurations. Individually adaptable.

Example of a security safe application:

With its modular layout and option of dismantling and reassembly at any time, your edge data centre expands to accommodate your growing requirements. The security safe provides complete protection from physical threats and ensures the requisite fail-safeness for automated production in Industry 4.0 environments.

IT Infrastructure	Product description	Packs of	Model No.
IT rack	Micro Data Center Level E	1	7999.009
IT power	PDU metered, 24 x C13/4 x C19, 1~, 32 A	2	7979.216
IT cooling	LCU DX, redundant, 6.5 kW	1	3311.493
IT monitoring	CMC III monitoring system Compact	1	7030.010
IT security	Fire alarm and extinguisher system DET-AC III	1	7338.121
IT accessories	IT LED system light, 600 lm	1	7859.000
	CAT 6, Network Cable Organizer	2	7044.110

All the variants shown are sample configurations. Individually adaptable.

Micro Data Center

High availability in a security safe



Optimum protection from physical threats

- Data such as personal patient data can be highly sensitive and must be protected from theft, while production data must be protected from physical threats such as dust, fire and splashed water.
- The Micro Data Center provides the perfect housing for data centres. The numerous options available, coupled with the opportunities for buying, make it an extremely flexible solution.
- With its modular layout and option of dismantling and reassembly at any time, your data centre can expand as your requirements grow. The security safe offers complete protection from physical threats in even the smallest space.

Options for adapting to your needs

- The Micro Data Center is available in two variants – Level B (solid basic protection) and Level E (maximum protection).
- Level E MDCs are also bayable and can be fitted around your current installed IT racks even while operational.
- There are a range of climate control options available, with varying dissipated thermal loads and redundancies. For example, cooling in a security safe may be designed as fully redundant.
- A fire alarm and extinguisher system protects your valuable IT components from threats inside the safe.

Simple configuration of tested system solutions

- With the Rittal Micro Data Center, your security safe solution can be tailored to your exact application.
- System-tested quality means that the entire solution has been tested for fire protection, intruder protection, smoke protection and water/dust-tightness in accordance with the specified standards.
- Testing has been carried out by accredited institutes and confirmed with test reports.



Micro Data Center Level E



System accessories Page 877

Applications:

- A high level of protection against potential physical threats for IT components
- Targeted configuration components transform the safe into a complete Micro Data Center

Benefits:

- As well as facilitating installation in poorly accessible sites, the modular design also makes it possible to retrospectively enclose existing IT structures.
- Extensibility, dismantling and re-assembly mean targeted, future-safe investments
- Tested security – testing has been carried out by accredited institutes and confirmed with test reports

Protection standards:

- Fire protection category F 90 to DIN 4102 Part 2
- Compliance with limit values $\Delta T < 50$ K, rel. humidity $< 85\%$ over 30 minutes
- Burglary resistance RC 2, optionally RC 3, tool attack analogous to DIN EN 1630/2011-09 and optionally WK 4, tool attack analogous to DIN V ENV 1630/1999-04/WK 4
- Smoke protection based on DIN 18 095-2: 1991-03

Material:

- Sheet steel, coated

Colour:

- Enclosure and service door: RAL 7035
- Operator door: RAL 9005

Protection category IP to IEC 60 529:

- IP 56

Supply includes:

- Micro Data Center with operator door and service door
- Cable entry in both side elements
- Both doors with key lock

Optional:

- Choice of door hinges
- Bifold doors
- Different cable entry systems and different positions
- Cable entry in the top/base unit
- Different lock variants
- Supporting structure

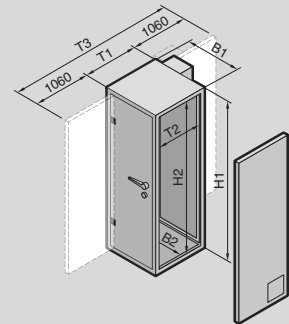

Note:

- The Micro Data Center is configured on a project-specific basis

U		42	47	42	47	Page
External dimensions mm	Width (B1)	1100	1100	1100	1100	
	Height (H1)	2210	2410	2210	2410	
	Depth (T1)	1200	1200	1400	1400	
	Depth (T3)	3320	3320	3520	3520	
Internal dimensions mm	Width (B2)	920	920	920	920	
	Height (H2)	2030	2230	2030	2230	
	Depth (T2)	1000	1000	1200	1200	
Model No.		7999.009	7999.009	7999.009	7999.009	
Empty weight excluding cooling unit and excluding rack approx. kg		660	700	730	800	
Accessories						
Fire alarm and extinguisher system DET-AC/EFD III		see page	see page	see page	see page	823
CMC III monitoring system		see page	see page	see page	see page	800
PSM – Modular Power Distribution Unit		see page	see page	see page	see page	744
PDU – Power Distribution Unit		see page	see page	see page	see page	732
LCU – Liquid Cooling Unit		see page	see page	see page	see page	768

Standard protection from:



Fire



Extinguishing water



Corrosive gases



Vandalism



Unauthorised access



Dust



Theft/burglary

Micro Data Center Level E

Level E, options

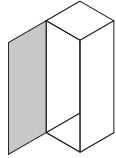
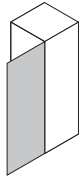
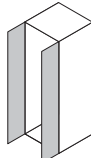
Operator door	L/h DIN door hinge	R/h DIN door hinge	Bifold door
			
	■	□	□

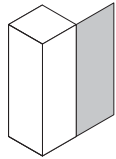
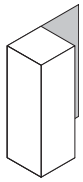
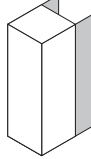

Service door	L/h DIN door hinge	R/h DIN door hinge	Bifold door
			
	■	□	□

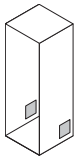
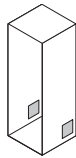
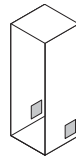
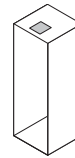
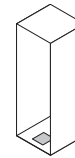
Cable entry	Soft duct ¹⁾ in both side elements	Hard duct ²⁾ in both side elements	Cable box ³⁾ in both side elements	Hard duct ²⁾ in top element	Hard duct ²⁾ in base element
					
	■	□	□	□	□





- ¹⁾ Size of soft duct: approx. 267 x 165 mm
For fire protection reasons, the duct may be configured up to a max. of 60% with a maximum cable diameter of 15 mm and a maximum conduit diameter of 18 mm.
- ²⁾ Size of hard duct: 2 panels each 120 x 120 mm
Cables up to a diameter of 15 mm may be routed through the hard duct.
- ³⁾ Size of cable box: Field 1 approx. 210 x 44, field 2 approx. 210 x 25 mm
Cables up to a diameter of 15 mm and hoses up to a diameter of 44 mm may be routed through the cable box.
No conduits may be routed through the cable box.
Other positions are also possible.

Locks	Key lock with 2 keys	Electronic combination lock ¹⁾	Electronic combination lock for activation via an access control system supplied by the customer
	■	□	□

¹⁾ First code, second code and double code allocation possible. Key-based opening for inspection purposes supported.

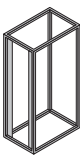

VX IT rack with air baffle plates								
	600				800			
Width mm								
Height mm	2000	2200	2000	2200	2000	2200	2000	2200
Depth mm	1000	1000	1200	1200	1000	1000	1200	1200
	□	□	□	□	□	□	□	□



Supporting structure	Steel supporting structure to compensate for the raised floor height when siting the security safe on the bare floor. The height of the supporting structure is selectable between 100 mm and 1000 mm.	Steel supporting structure to compensate for the raised floor height when siting the security safe on the bare floor. The supporting structure has a fire-proof covering. The height of the supporting structure is selectable between 100 mm and 1000 mm.
	□	□

■ Included with the supply □ Optional

Micro Data Center Level B



System accessories Page 877

Applications:

- Basic protection against potential physical threats for IT components.
- Targeted configuration components transform the safe into a complete Micro Data Center.

Benefits:

- Modular layout for installation in hard-to-access locations
- Lower weight than the Level E Micro Data Center
- Tested security – testing has been carried out by accredited institutes and confirmed with test reports

Protection standards:

- Fire protection – fire resistance class EI 90/F 90 to DIN EN 1363-1: 1999 based on DIN 4102-2: 1997
- Burglar resistance RC 2 Tool attack analogous to DIN EN 1630/2011-09/RC 2
- Smoke protection based on DIN EN 1634-3: 2005-01

Material:

- Sheet steel, coated

Colour:

- Enclosure and service door: RAL 7035
- Operator door: RAL 9005

Protection category IP to IEC 60 529:

- IP 56

Supply includes:

- Security safe with integral VX frame
- 482.6 mm (19") mounting angles, standard, front and rear
- Adjusted air baffle plates
- Every side element is prepared for one cable entry at the bottom and one cable entry at the top
- Operator and service door with swing-lever handle and profile half-cylinder

Optional:

- Choice of door hinges
- Bifold doors
- Different cable entry systems and different positions
- Different lock variants
- Supporting structure with fire protection

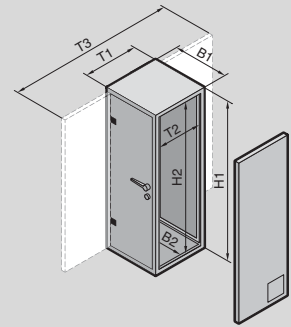

Note:

- The Micro Data Center is configured on a project-specific basis

U		42	47	42	47	Page
External dimensions mm	Width (B1)	1115	1115	1115	1115	
	Height (H1)	2205	2405	2205	2405	
	Depth (T1)	1377	1377	1577	1577	
	Depth (T3)	3274	3274	3474	3474	
Internal dimensions mm	Width (B2)	905	905	905	905	
	Height (H2)	2000	2200	2000	2200	
	Depth (T2)	1060	1060	1260	1260	
Model No.		7999.709	7999.709	7999.709	7999.709	
Empty weight excluding cooling unit approx. kg		595	630	660	700	
Accessories						
	Fire alarm and extinguisher system DET-AC/EFD III	see page	see page	see page	see page	823
	CMC III monitoring system	see page	see page	see page	see page	800
	PSM – Modular Power Distribution Unit	see page	see page	see page	see page	744
	PDU – Power Distribution Unit	see page	see page	see page	see page	732
	LCU – Liquid Cooling Unit	see page	see page	see page	see page	768

Standard protection from:



Fire



Extinguishing water



Corrosive gases



Vandalism



Unauthorised access



Dust



Theft/burglary

Micro Data Center Level B

Level B, options

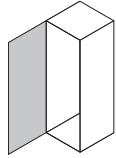
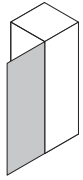
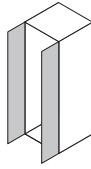
Operator door	L/h DIN door hinge	R/h DIN door hinge	Bifold door
			
	■	□	□

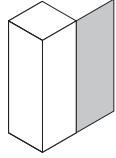
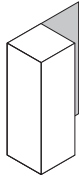
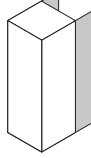

Service door	L/h DIN door hinge	R/h DIN door hinge	Bifold door
			
	■	□	□

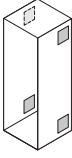
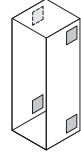

Cable entry	Soft duct ¹⁾ in both side elements	Cable box ²⁾ in both side elements
		
	■	□



- ¹⁾ Size of soft duct: approx. 267 x 165 mm
For fire protection reasons, the duct may be configured up to a max. of 60% with a maximum cable diameter of 15 mm and a maximum conduit diameter of 18 mm.
- ²⁾ Size of cable box: Field 1 approx. 210 x 44, field 2 approx. 210 x 25 mm. Cables up to a diameter of 15 mm and hoses up to a diameter of 44 mm may be routed through the cable box. No conduits may be routed through the cable box.

Locks	Swing lever handle with interchangeable profile half-cylinder	Swing lever handle with electronic lock for external activation	Swing lever handle with electronic lock with combination code
	■	□	□



Supporting structure	Steel supporting structure to compensate for the raised floor height when siting the security safe on the bare floor. The supporting structure has a fire-proof covering. The height of the supporting structure is selectable between 100 mm and 1000 mm.		
	□	□	□

■ Included with the supply □ Optional

RiMatrix S

The standardised data centre



IT infrastructure – Fully operational

The RiMatrix S standardised data centre is suitable for all architectures, be it main data centres, small data centres in distributed locations, or edge data centres located outdoors. The local conditions are of secondary importance, because RiMatrix S can be used both in existing properties and in container data centres.

The significantly reduced planning times are key, because these highly efficient modules are fully pre-planned, including existing data sheets, implementation diagrams and documentation.

In the longer term, another benefit of this system-tested solution is a significant reduction in your electricity bills, with detailed calculations possible even at the planning phase.

Save time when planning

- Easily select your required modules with just one Model No.
- Complete documentation available at the planning phase
- Short delivery times and fast commissioning
- Pre-assembled modules for the installation of IT equipment, ready to use immediately
- Simplified final certification of the finished data centre

Efficient technology

- Unique, efficient cooling solution
- Space-saving climate control in the raised floor
- n+1 redundancy in the power supply and cooling
- Complete low-voltage distribution system and PDUs pre-installed in the racks, UPS built into selected modules
- Optional packages for comprehensive PUE (power usage effectiveness) monitoring using a prefabricated DCIM solution are available
- Documented low PUE (power usage effectiveness) of between 1.5 and 1.15
- Documented system test of the entire data centre module

Scalability from the edge to the cloud

- Standardised modules for simplified worldwide delivery
- Simple, uniform connection to supply infrastructures
- Different modules with outputs ranging from 10 kW to 450 kW (scalable)
- For use in existing premises in a simple protective cover or robust container structure

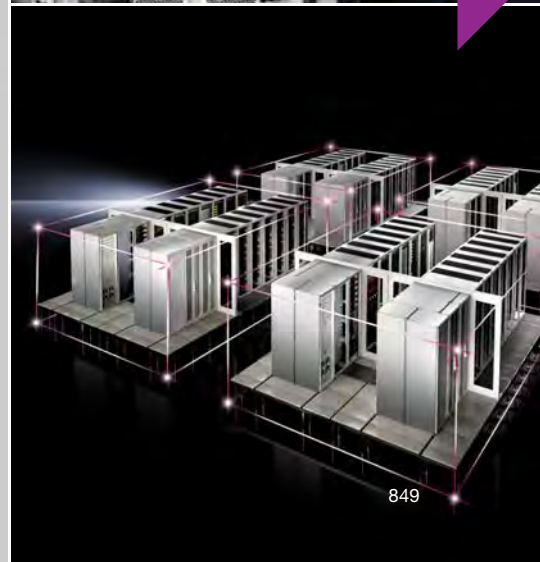

RiMatrix S at a glance



Standard room

The standardised data centre is assembled at your premises within the context of hot aisle/cold aisle containment.

Benefits:

- Aisle containment is a combination of door and roof components which allow consistent separation of the hot and cold air

Supply includes:

- Advice and ROI calculation
- Delivery and integration into the customer infrastructure
- Commissioning and handover
- Documentation, training, instruction
- Hotline and service/service agreements
- Precise-fit aisle containment

	Single 6	Double 6	Single 9	Double 9
Model No.	7998.106	7998.107	7998.406	7998.407
Exterior dimensions, width mm	2807	4839	2807	4839
Exterior dimensions, height mm	2750	2750	2750	2750
Exterior dimensions, depth mm	7067	7070	7067	7070
Interior dimensions, width mm	2750	4774	2750	4774
Interior dimensions, height mm	2722	2722	2722	2722
Interior dimensions, depth mm	7000	7000	7000	7000
Fire protection	–	–	–	–
Burglar resistance	–	–	–	–
Acrid gas-tightness	–	–	–	–
Dust- and water-tightness	IP 20	IP 20	IP 20	IP 20
Basic EMC protection	–	–	–	–
Early fire detection	■	■	■	■
Room extinguisher system	optional	optional	optional	optional
Humidification and dehumidification system	optional	optional	optional	optional
Server rack (600 x 2000 x 1200 mm)	6	12	8	16
Combined network/server rack (800 x 2000 x 1200 mm)	1	2	1	2
Uninterruptible power supply	60 kW + 20 kW n+1 redundant	2 x (60 kW + 20 kW) n+1 redundant	–	–
Low-voltage main distribution board (NSHV)	1	2	1	2
PDU basic	14	28	18	36
Climate control (ZUCS)	60 kW + 10 kW n+1 redundant	120 kW + 20 kW n+2 redundant	90 kW + 10 kW n+1 redundant	180 kW + 20 kW n+2 redundant
Efficiency package	7998.905	7998.906	7998.907	7998.908

RiMatrix S at a glance



	Security room				Container			
	<p>The standardised data centre at your premises is equipped with an additional security room (room-within-a-room) to provide additional protection from fire, water and smoke.</p> <p>Material:</p> <ul style="list-style-type: none"> – Element core made from thermally effective insulating material – Robust, encapsulated sheet steel cassette panels – Innovative connection system using patented profile technology – Use of temperature- and humidity-resistant seals – Optional use of overpressure control dampers – Dismantling and reassembly are possible at any time 				<p>Supply includes:</p> <ul style="list-style-type: none"> – Advice and ROI calculation – Delivery and integration into the customer infrastructure – Commissioning and handover – Documentation, training, instruction – Hotline and service/service agreements 		<p>The standardised data centre is implemented in a container solution and can due to the robust sheet steel container construction be sited outdoors if required.</p> <p>Supply includes:</p> <ul style="list-style-type: none"> – Robust sheet steel container with reinforced frame structure for optimum weight distribution – Housed interior wall structure with thermal insulating materials – Advice and ROI calculation – Delivery and integration into the customer infrastructure – Documentation, training, instruction – Hotline and service/service agreements 	
	Single 6	Double 6	Single 9	Double 9	Single 6	Single 9		
	7998.306	7998.307	7998.606	7998.607	7998.206	7998.506		
	2950	4976	2950	4976	3000	3000		
	2800	2800	2800	2800	3000	3000		
	7420	7420	7420	7420	7250	7250		
	2750	4776	2750	4776	2750	2750		
	2700	2700	2700	2700	2700	2700		
	7220	7220	7220	7220	7000	7000		
	EI 90 according to EN 1363/F 90 based on DIN 4102	EI 90 according to EN 1363/F 90 based on DIN 4102	EI 90 according to EN 1363/F 90 based on DIN 4102	EI 90 according to EN 1363/F 90 based on DIN 4102	–	–		
	RC III	RC III	RC III	RC III	RC II	RC II		
	■	■	■	■	–	–		
	IP 56	IP 56	IP 56	IP 56	IP 55	IP 55		
	■	■	■	■	■	■		
	■	■	■	■	■	■		
	optional	optional	optional	optional	optional	optional		
	optional	optional	optional	optional	optional	optional		
	6	12	8	16	6	8		
	1	2	1	2	1	1		
	60 kW + 20 kW n+1 redundant	2 x (60 kW + 20 kW) n+1 redundant	–	–	60 kW + 20 kW n+1 redundant	–		
	1	2	1	2	1	1		
	14	28	18	36	14	18		
	60 kW + 10 kW n+1 redundant	120 kW + 20 kW n+2 redundant	90 kW + 10 kW n+1 redundant	180 kW + 20 kW n+2 redundant	60 kW + 10 kW n+1 redundant	90 kW + 10 kW n+1 redundant		
	7998.905	7998.906	7998.907	7998.908	7998.905	7998.907		

Data centre container

The modular concept for complete IT infrastructures



IT technology plus matching infrastructure equals a complete system

Growing data volumes and escalating requirements are creating ever more problems with space. Modular containers suitable for outdoor siting offer a possible solution and are highly scalable. Thanks to the container structure, a data centre can be planned with minimal effort and extended in the future. RiMatrix Data Cubes are a modular system from Rittal which provide the ideal basis for suitable projects and include server, power and cooling modules. There is also an all-in-one (AIO) variant available as a plug & play solution, in which the server zone and technical room are accommodated together in a single module.

A scalable, modular system

- This flexible solution accommodates the specific requirements of individual applications
- Simple selection options help to streamline planning, with detailed planning of individual assemblies specifically for the application in each container
- Standardised components with tested and certified safety.
- Industrial production of the entire container is very fast, with installation and cabling of the IT hardware on request
- Suitable for outdoor siting
- Reduced installation phase thanks to the plug & play principle
- High level of scalability
- Mobile and future-proof

Efficiency and service

- Low CO₂ emissions: Modern IT cooling units from Rittal support high levels of efficiency in containers compared with conventional data centres
- Continuous advice and planning from the Rittal data centre experts
- Servicing and preventive maintenance help to safeguard the longevity and maximum availability of your infrastructure



RiMatrix Data Cube Cooling:

Efficient recooling systems in the container frame, ready to connect and system-tested with redundant chillers, free-cooling mode or additional free cooler and network functions

RiMatrix Data Cube IT:

Ready-to-connect IT infrastructure in a robust container shell, as standardised IT modules in a range of output categories for SME, Cloud and Edge applications.

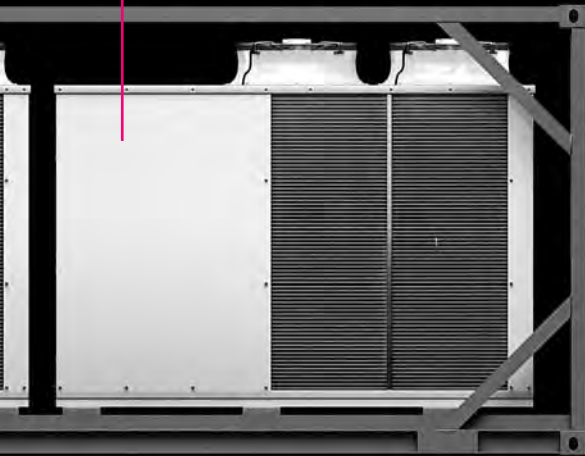

Robust container cover:
For siting outdoors, standardised dimensions for reduced planning effort

Modular raised floor:
In a range of application-specific heights

Network racks:
Pre-configured type VX IT for installing network technology and structured cabling, with two PDUs for redundant power supply

Server racks:
Pre-configured type VX IT for server installation, with cable guide rails and two PDUs for redundant power supply in the server exhaust air zone

RiMatrix Data Cube

Modules with maximum scalability

From individual all-in-one containers through to large container parks, Rittal offers the maximum possible scalability with its comprehensive portfolio of solutions. For larger applications, uninterruptible power supply and cooling modules in the same container pitch pattern are added to the RiMatrix Data Cubes.

For the conventional components of rack, power, cooling and monitoring, Rittal and its strategic partners Innovo Cloud and Lefdal also offer "IT as a Service", together with a location – the Lefdal Mine Datacenter in Norway – which can save up to 40 percent energy costs annually compared with a data centre in Germany.

RiMatrix Data Cube Power:
Modular UPS systems with redundancy to supply one or more IT modules



Individual equipment:
All containers are equipped with the necessary infrastructure (lighting, service sockets, structured cabling etc.)

Low-voltage distributor:
Complete distributor system with connection point for the main supply and the outgoing feeders from all PDUs

IT cooling:
Cold water or coolant-based systems for energy-efficient cooling of the entire server inlet air zone, speed-controlled and with redundancy

RiMatrix Data Cube IT



Design			RDC IT 50/10-L-III	RDC IT 60/12-L-II
Maximum total IT output in kW			50	60
Maximum IT output per rack in kW			5	5
Redundancy of cooling system			2n	n+1
Redundancy of power supply			2n	2n
Cooling concept			LCP systems are positioned between the racks, and depending on the variant, are either flush with or set forward from the enclosure suite. These systems cool the entire cold aisle in front of the servers and have a redundant design in the container variants. The variants with a second set of cold water pipelines also support n+n redundancies.	
Power concept			The container main power supply is split among individual outgoing feeders to the PDUs in the individual enclosures via a low-voltage distributor. Each enclosure has an A supply and a B supply, thereby achieving n+1 redundancy. The main distributor offers separate connections for the A and B supply to which one or two UPS-buffered supply lines may be connected. A RiMatrix Data Cube Power with integral UPS may also be used to supply the containers. The container peripherals are supplied via an additional C-line.	
Racks	Server rack W x H x D mm	600 x 2000 x 1200	10	12
	Network rack W x H x D mm	800 x 2000 x 1200	1	1
	Technical rack W x H x D mm	600 x 2000 x 600	–	–
		600 x 2000 x 1200	1	1
Current	Low-voltage distributor		1	1
	UPS, modular		–	–
	PDU		11 x 2	13 x 2
Cooling	Quantity		6 x LCP CW	4 x LCP CW
	Pipe systems		2 set(s)	1 set(s)
Container size L x W x H mm (external dimensions)			12192 (40 ft.) x 3000 x 3000	12192 (40 ft.) x 3000 x 3000

SME, cloud and Edge applications



	RDC IT 90/8-M-I	RDC IT 100/10-L-II	RDC IT 100/10-L-III
	90	100	100
	10	10	10
	n+1	n+1	2n
	2n	2n	2n
	Use of the zero-U-space cooling system (ZUCS) optimises use of the interior space by positioning the cooling units underneath the racks in the raised floor. Efficient EC fans ensure a constant server inlet air temperature in the shielded cold aisle. This system provides a redundancy of n+1.	LCP systems are positioned between the racks, and depending on the variant, are either flush with or set forward from the enclosure suite. These systems cool the entire cold aisle in front of the servers and have a redundant design in the container variants. The variants with a second set of cold water pipelines also support n+n redundancies.	
	The container main power supply is split among individual outgoing feeders to the PDUs in the individual enclosures via a low-voltage distributor. Each enclosure has an A supply and a B supply, thereby achieving n+1 redundancy. The main distributor offers separate connections for the A and B supply to which one or two UPS-buffered supply lines may be connected. A RiMatrix Data Cube Power with integral UPS may also be used to supply the containers.	The container main power supply is split among individual outgoing feeders to the PDUs in the individual enclosures via a low-voltage distributor. Each enclosure has an A supply and a B supply, thereby achieving n+1 redundancy. The main distributor offers separate connections for the A and B supply to which one or two UPS-buffered supply lines may be connected. A RiMatrix Data Cube Power with integral UPS may also be used to supply the containers. The container peripherals are supplied via an additional C-line.	
	8	10	10
	1	1	1
	1	–	–
	–	1	1
	1	1	1
	–	–	–
	9 x 2	11 x 2	11 x 2
	9 x ZUCS	6 x LCP CW	6 x LCP CW
	1 set(s)	1 set(s)	2 set(s)
	7250 x 3000 x 3000	12192 (40 ft.) x 3000 x 3000	12192 (40 ft.) x 3000 x 3000

RiMatrix Data Cube IT



Design		RDC IT 200/10-L-II	
Maximum total IT output in kW		200	
Maximum IT output per rack in kW		20	
Redundancy of cooling system		n+1	
Redundancy of power supply		2n	
Blob arrangement		–	
Cooling concept		Energy-efficient LCP systems with a cold water supply are used as cooling systems, and can each produce a cooling output of up to 55 kW. These systems are positioned in the row between the server racks and can easily be set forward into the cold aisle. This brings the cold air directly in front of the servers for cooling without deflection losses.	
Power concept		The container main power supply is split among individual outgoing feeders to the PDUs in the individual enclosures via a low-voltage distributor. Each enclosure has an A supply and a B supply, thereby achieving n+1 redundancy. The main distributor offers separate connections for the A and B supply to which one or two UPS-buffered supply lines may be connected. A RiMatrix Data Cube Power with integral UPS may also be used to supply the high-performance containers. The container peripherals are supplied via an additional C-line.	
Racks	Server rack W x H x D mm	600 x 2000 x 800	–
		600 x 2000 x 1200	10
	Network rack W x H x D mm	800 x 2000 x 800	–
		800 x 2000 x 1200	1
Technical rack W x H x D mm	600 x 2000 x 1200	1	
Current	Low-voltage distributor		1
	UPS, modular		–
	PDU		11 x 2
Cooling	Quantity		6 x LCP CW
	Pipe systems		1 set(s)
Container size L x W x H mm (external dimensions)			12192 (40 ft.) x 3000 x 3000

SME, cloud and Edge applications



	RDC IT 200/10-L-I	RDC IT 200/10-ISO L-I
	200	200
	20	20
	n+1	n+1
	2n	2n
	The racks and cooling systems are arranged so that two racks form a unit with one LCP. An additional LCP in the suite ensures redundancy. All racks are cooled evenly and energy-efficiently via the shared cold aisle, even with varying loads.	
	Energy-efficient LCP systems with a cold water supply are used as cooling systems, and can each produce a cooling output of up to 55 kW. These systems are positioned in the row between the server racks and can easily be set forward into the cold aisle. This brings the cold air directly in front of the servers for cooling without deflection losses.	
	The container main power supply is split among individual outgoing feeders to the PDUs in the individual enclosures via a low-voltage distributor. Each enclosure has an A supply and a B supply, thereby achieving n+1 redundancy. The main distributor offers separate connections for the A and B supply to which one or two UPS-buffered supply lines may be connected. A RiMatrix Data Cube Power with integral UPS may also be used to supply the high-performance containers. The container peripherals are supplied via an additional C-line.	
	–	10
	10	–
	–	1
	1	–
	–	–
	1	1
	–	–
	11 x 2	11 x 2
	7 x LCP CW	7 x LCP CW
	1 set(s)	1 set(s)
	12192 (40 ft.) x 3000 x 3000	12192 (40 ft.) x 2438 x 2896 (ISO High Cube)

RiMatrix Data Cube All-in-One



Design			RDC AIO 35/3-M-II	RDC AIO 45/8-L-II	
Maximum total IT output in kW			35	45	
Maximum IT output per rack in kW	Server rack		10	5	
	Network rack		5	5	
Redundancy of cooling system			n+1	n+1	
Redundancy of power supply			2n	2n	
Cooling concept			LCP systems are positioned between the racks, and depending on the variant, are either flush with or set forward from the enclosure suite. These systems cool the entire cold aisle in front of the servers and have a redundant design in the container variants. Coolant-based DX systems may also be used in the AIO variants, which are linked to the relevant external unit. These may also be optionally secured directly to the outer container sleeve.		
Power concept			The container main power supply is split among individual outgoing feeders to the PDUs in the individual enclosures via a low-voltage distributor. Each enclosure has an A supply and a B supply, thereby achieving n+1 redundancy. The main distributor offers separate connections for the A and B supply; the integral modular UPS is positioned directly at the infeed to the B-line. The container peripherals are supplied via an additional C-line.		
Racks	Server rack W x H x D mm	600 x 2000 x 1200	3	8	
	Network rack W x H x D mm	800 x 2000 x 1200	1	1	
	Technical rack W x H x D mm	600 x 2000 x 600	-	-	
		600 x 2000 x 1200	-	-	
Current	Low-voltage distributor		1	1	
	UPS, modular		40 + 20 kW	60 + 20 kW	
	PDU		4 x 2	9 x 2	
Cooling	Quantity		5 x LCP DX	6 x LCP DX	
	Pipe systems		Single	Single	
Container size L x W x H mm (external dimensions)			7250 x 3000 x 3000	12192 (40 ft.) x 3000 x 3000	

SME, cloud and Edge applications



	RDC AIO 60/6-M-I	RDC AIO 90/8-L-II	RDC AIO 180/16-L-II	RDC AIO 180/16-L-III
	60	90	180	180
	10	10	10	10
	–	5	5	5
	n+1	n+1	n+1	2n
	2n	2n	2n	2n
	Use of the zero-U-space cooling system (ZUCS) optimises use of the interior space by positioning the cooling units underneath the racks in the raised floor. Efficient EC fans ensure a constant server inlet air temperature in the shielded cold aisle. This system provides a redundancy of n+1.	LCP systems are positioned between the racks, and depending on the variant, are either flush with or set forward from the enclosure suite. These systems cool the entire cold aisle in front of the servers and have a redundant design in the container variants. The variants with a second set of cold water pipelines also support n+n redundancies.		
	The container main power supply is split among individual outgoing feeders to the PDUs in the individual enclosures via a low-voltage distributor. Each enclosure has an A supply and a B supply, thereby achieving n+1 redundancy. A UPS is already integrated into the RDC-AIO 60/6-M-II.	The container main power supply is split among individual outgoing feeders to the PDUs in the individual enclosures via a low-voltage distributor. Each enclosure has an A supply and a B supply, thereby achieving n+1 redundancy. The main distributor offers separate connections for the A and B supply; the integral modular UPS is positioned directly at the infeed to the B-line. The container peripherals are supplied via an additional C-line.		
	6	8	2 x 8	2 x 8
	1	1	2 x 1	2 x 1
	1	–	–	–
	–	–	–	–
	1	1	2 x 1	2 x 1
	60 + 20 kW	100 + 20 kW	2 x (100 + 20 kW)	2 x (100 + 20 kW)
	7 x 2	9 x 2	2 x (9 x 2)	2 x (9 x 2)
	6 x ZUCS for server zone 1 x ZUCS for UPS zone	6 x LCP CW	2 x (6 x LCP CW)	2 x (6 x LCP CW)
	1 set(s)	1 set(s)	2 x 1 set(s)	2 x 2 set(s)
	7250 x 3000 x 3000	12192 (40 ft.) x 3000 x 3000	12192 (40 ft.) x 3000 x 3000	12192 (40 ft.) x 3000 x 3000

Security room

High availability for data centres



Customised protection from physical threats

- Innovative services provided by regional governments and banks, for example, demand the highest standards of security for storing sensitive citizen data and protecting it from manipulation.
- This data must be protected from physical threats such as fire, smoke, corrosive gases, dust and water, as well as unauthorised access.
- Security rooms are a room-within-a-room solution, in other words, a security room is constructed from base, wall and ceiling elements in an existing building and can be flexibly adapted to suit the local conditions, especially if changes cannot be made to the building's structure.

Adaptation to the building infrastructure and operational IT requirements

- The basic protection room/basic protection Plus room provides a high-quality, system-tested solution. The basic protection room is an optimum, modular room-within-a-room solution for protecting IT components and creating technical rooms. The flexible modular system allows it to be extended whilst operational.
- The high-availability room offers maximum physical protection for data centres. The system was certified by ECB (European Certification Body GmbH) to ECB-S regulations. The modular concept offers the same benefits as a basic protection room, but with a higher level of protection.

Tested system solutions

- System-tested quality means that the entire solution has been tested for fire protection, intruder protection, smoke protection and water-/dust-tightness in accordance with the specified standards.
- System testing covers the entire structure, comprising the cell structure and built-in modules such as doors, cable shields and ventilation units.
- Testing is carried out by accredited institutes and documented in test reports.



IT infrastructure



Basic Protection room and Basic Protection Plus room (GSR)



Standard protection from:



Fire



Extinguisher water



Corrosive gases



Vandalism



Unauthorised access



Dust



Falling debris



Theft/burglary

IT power Page 722 IT cooling Page 756 IT monitoring Page 798

Your benefits with GSR, GSR Plus and HVR

- System-tested protection
- Multi-functional risk coverage
- Dust- and noise-reduced installation
- Dismantling and reassembly plus extendibility = investment security
- Adaptation of the different room systems

With HVR only:

- System-tested high-availability protection
- ECB-S certification
- Independent quality monitoring



High security requirements

The Basic Protection room provides a system-tested solution for protecting infrastructure components such as extinguisher systems, uninterruptible power supplies and cooling.

The Basic Protection Plus room also offers solid basic protection for IT in addition to protection of infrastructure components.

Structure of the Basic Protection room

- Element core made from thermally effective insulating material
- Robust, encapsulated sheet steel cassette panels
- Innovative connection system using patented profile technology
- Use of temperature- and humidity-resistant seals

Criterion	Standard
System testing	 System testing
Fire protection	 ECB-S certification to EN 1047-2, 50 K temperature increase and 85% rel. humidity up to 24 hours (post-heating period), 60 minutes flame impingement time 50 K temperature increase and 85% rel. humidity without post-heating period, flame impingement time 30 minutes F 120 to DIN 4102; EI 120 (wall) to EN 1363 (component-tested) F 90 to DIN 4102 EI 90 to EN 1363
Corrosive combustion gases	Acrid gas-tightness based on DIN 18 095
Falling debris	Impact test 200 kg from a drop height of 1.5 m with impact energy of 3,000 Nm Protection category IP X6 to IEC 60 529
Water	Protection from standing water
Dust	Protection category IP 5X to IEC 60 529
Unauthorised access	Resistance class RC4, tool attack analogous to DIN/EN 1630, door system only Resistance class RC3, tool attack analogous to DIN/EN 1630 Resistance class RC2, tool attack analogous to DIN/EN 1630
Explosion	Detonation test
EMC	Shield attenuation levels of up to 60 dB in the frequency range from 30 MHz to 3 GHz

System-tested structures are tested as a complete unit, comprising the cell structure and built-in modules such as doors, cable shields or ventilation units. By contrast, generic component testing only refers to individual parts.

Conventional construction methods refer to room structures made of plasterboard, concrete and other standard construction materials which do not offer sufficient protection for data centre applications. Conventional construction methods are generally unsuitable for use as a fire wall and are only component-tested.

High-Availability room (HVR)

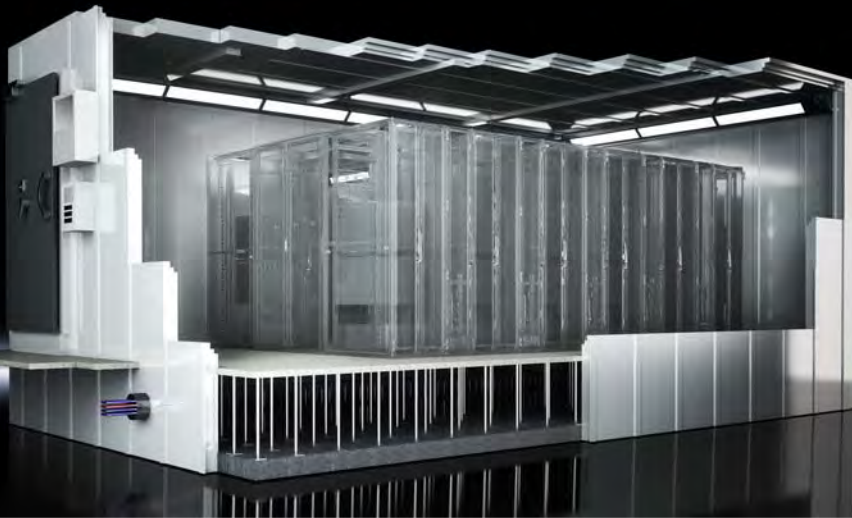

Standard protection from:



Fire



Extinguisher water



Corrosive gases



Vandalism



Unauthorised access



Dust



Explosion



Falling debris



Theft/burglary



Mechanical access

IT power Page 722 IT cooling Page 756 IT monitoring Page 798

Maximum security

The High-Availability room offers maximum physical protection for data centres and IT system locations. The system was certified by ECB (European Certification Body GmbH) to ECB-S regulations. This certification confirms that the High-Availability room meets the requirements of EN 1047-2 without restriction. Moreover, the construction of the security room is subject to continuous quality monitoring by an independent agent.

Structure of the High-Availability room

- Complex 4-layer element core made of thermally effective insulation substances
- Robust, encapsulated sheet steel cassette panels
- ECB-S tested, multiple lock, panic release
- Patented connection system
- Fireproof floor elements
- Use of extremely temperature- and humidity-resistant seals

	Basic Protection room	Basic Protection Plus room	High-Availability room
	■	■	■
	-	-	■
	-	■	■
	-	-	■
	■	■	■
	■	■	-
	■	■	■
	■	■	■
	-	-	■
	■	■	■
	-	-	■
	-	□	■
	■	■	■
	-	-	■
	□	□	□

■ Standard □ Option

Open Compute Project (OCP)

Big data is a subject which is shaking up many areas of industry, commerce and trade. It is not only that data volumes are increasing exponentially. Also important is that efficient and fast data processing will in future be more and more decisive for business success.

The OCP community came together to find solutions to this challenge. The prime objective of the Open Compute Project (OCP) is to reduce the investment and operating costs, energy consumption and environmental impact of data centres by way of innovative, fully standardised IT architectures. To this end, the OCP provides an open platform for the sharing of ideas and know-how, as a vehicle for the definition of ground-breaking standards for the data centre of the future.

IT infrastructure – Architectures for the future

As a leading manufacturer of IT infrastructures, Rittal is proud to be a member of the OCP community. Expertise in the standardization of data centre architectures, in particular, has established Rittal's reputation as a strong partner when it comes to demanding OCP-related tasks.

As well as building application-specific racks, Rittal has also extended its standard portfolio to include the Open Compute Project segment. This means that Rittal can now handle customer-specific enquiries as well as requests for standardised racks based on the latest OCP design. As well as the rack itself, Rittal also offers a comprehensive range of accessories, a special power supply unit, and a cooling system tailored to innovative OCP architecture, reinforcing Rittal's image as an operational technology (OT) portfolio provider to the OCP segment.



In a joint collaboration with Bel Power Solutions & Protection, Rittal provides power supplies for OCP racks. These innovative and efficient power distributors are a key element of any OCP architecture. Substantial power savings can be made by transforming the power centrally and distributing it via the busbars that typify an OCP system.



48 V DC/36 kW

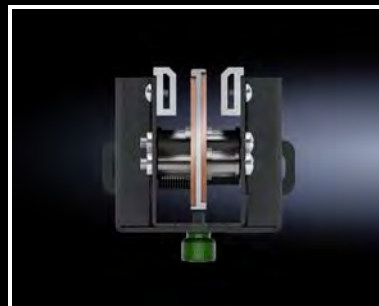

48 V DC/15 kW



12 V DC/6.6 – 13.2 kW

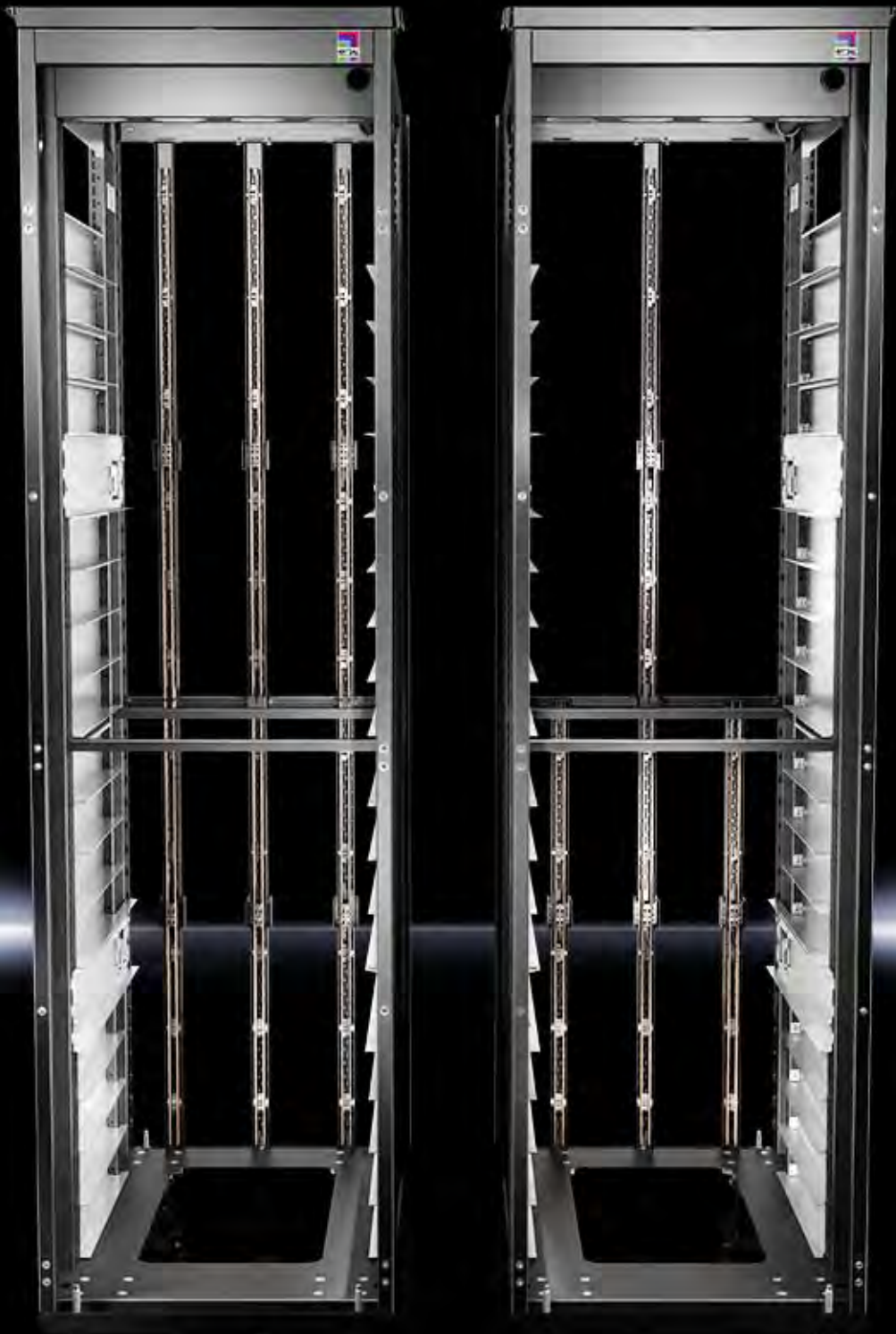

Open Compute Project (OCP)

Rack design for greater flexibility



Tried-and-tested rack design

- Complies with Open Rack Standards 1.2 and 2.0
- Stable, firmly linked frame structure on castors
- Prepared to accommodate special OCP hardware with a system width of 21" at the front
- Highly efficient power distribution by connecting the hardware directly to the busbar integrated into the rack
- UL listed, CE compliant
- Variants available for both system voltages 12 V DC and 48 V DC
- Potential output range of a rack based on OCP: 13.2 kW – 40 kW

More flexibility

- Doors available with a broad selection of lock options for keys, magnetic cards or numerical codes
- One-piece side panel for the end of row (EOR) rack
- Modular configuration of busbars

Variable interior

- Height units in the Open Compute Design with a variable OpenU pitch pattern (OU) from 1 OU (48 mm) to 3 OU
- Preconfigured slide rails for direct installation of servers, height-adjustable on the OpenU (OU) pitch pattern
- 21"19" adaptor for the additional integration of 482.6 mm (19") components optionally available
- Standard 1 U 482.6 mm (19") adaptor for tool-free installation of 19" hardware
- Special 482.6 mm (19") EIA brackets in various heights to accommodate multiple 19" devices



Standard R-OCP V2 rack



OCP rack, 41 OpenU (OU), for use in energy-efficient IT architectures based on the principles of the Open Compute Project. Depending on the variant, with split 12 V DC busbar fitted at the rear, or without busbar for individual configuration. Depending on accessories and the use of power packs, one (single) or two (dual) power zones may be used in the rack.

Benefits:

- Complies with Open Rack Standards 1.2 and 2.0
- Stable, firmly linked frame structure on castors
- Height units in the Open Compute Design with a variable OpenU pitch pattern (OU) of between 1 OU (48 mm) and 3 OU
- Pre-assembled slide rails for direct installation of servers, height-adjustable on the OpenU (OU) pitch pattern
- Prepared to accommodate special OCP hardware with a system width of 21" at the front
- Highly efficient power distribution by connecting the hardware directly to the 12 V DC busbar integrated into the rack
- 21"/19" adaptor for the additional integration of 482.6 mm (19") components optionally available
- Matching OCP power packs (power shelves) and batteries (back-up units) for central power supply and protection optionally available in the rack
- Extendible up to a maximum of 3 busbars

Material:

- Frame: Sheet steel

Colour:

- RAL 9005

Supply includes:

- Firmly linked frame structure, with fitted castors, without doors, without side panels
- 2 pairs of slide rails, 3 OU, pre-assembled
- 16 pairs of slide rails, 2 OU, pre-assembled

Please observe the product-specific scope of supply.

Standards:

- Open Rack Standard V2

Approvals:

- UL

Units OU	Packs of	41	41	Page
Width mm		600	600	
Height mm		2246	2246	
Depth mm		1068	1068	
Design		OCP V2 rack, deep, without busbar, for individual configuration	OCP V2 rack, deep, incl. preconfigured 12 V DC busbar with 2 power zones	
Load capacity		15,000 N	15,000 N	
Colour		RAL 9005	RAL 9005	
Power consumption min./max. kW		-	6.6 / 13.2	
Model No.	1 pc(s).	7100.200	7100.221	
Product-specific scope of supply				
1 x OCP busbar 12 V DC		-	■	
Also required				
OCP busbar	1 pc(s).	7100.312	-	871
Accessories				
OCP busbar	1 pc(s).	-	7100.312	871
OCP adaptor	2 pc(s).	7100.401	7100.401	871
OCP V2 side panel	2 pc(s).	7100.501	7100.501	871
OCP PDU		see page	see page	872

OCP busbar

Design	Output range	Packs of	Model No.
12 V DC	6.6 - 13.2 kW	1 pc(s).	7100.312

OCP busbar 12 V DC for power distribution in a standard R-OCP V2 rack. The busbar is fitted at the rear and is used to supply power to the hardware in the rack. The hardware and busbar make contact via a clip connection at the rear of the hardware.

Benefits:

- Multiple 12 V DC busbars may be combined
- Simple configuration of two to one power zone
- Greater energy efficiency with silver-plated contact area

Material:

- Copper, zinc-plated, silver-plated

Supply includes:

- Assembly parts

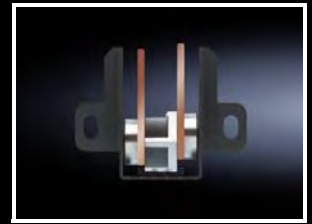

OCP V2 side panel

Height mm	Depth mm	Packs of	Model No.
2246	1068	2 pc(s).	7100.501

OCP V2 side panel, 1-piece, for finishing off a rack suite with standard R-OCP V2 racks.

Material:

- Sheet steel

Colour:

- RAL 9005

Supply includes:

- Assembly parts



OCP adaptor

21"/19"

Adaptor for installing 482.6 mm (19") components in the 21" OCP rack system. The adaptor is screw-fastened to the enclosure frame.

U OU	Packs of	Model No.
1	2 pc(s).	7100.401

Material:

- Sheet steel

Supply includes:

- Assembly parts



OCP

Accessories



OCP PDU

The OCP PDU installed on the rack is needed to supply power to the OCP power shelves. The OCP PDU distributes power from the data centre to the power shelves fitted in the rack.

Material:

- Enclosure: Sheet steel

Supply includes:

- Connection cable

Input voltage	Infeeds	Phases per infeed	Output voltage	Number of outputs	Rated voltage A	Type of electrical connection	Overvoltage protection	To fit Model No.	Packs of	Model No.
240 / 415 V AC	1	3~	240 / 415 V AC	2	32	IEC 60 309	■	7100.200/ 7100.221	1 pc(s).	7100.911
277 / 480 V AC	2	3~	277 / 480 V AC	2	20	L22-20P	■	7100.200/ 7100.221	1 pc(s).	7100.912
277 / 480 V AC	1	3~	277 / 480 V AC	2	30	L22-30P	■	7100.200/ 7100.221	1 pc(s).	7100.913
48 V DC	2	–	48 V DC	2	250	–	–	7100.200/ 7100.221	1 pc(s).	7100.914
200 / 415 V AC	1	3~	54.5 V DC	3	–	–	–	7100.200	1 pc(s).	7100.915

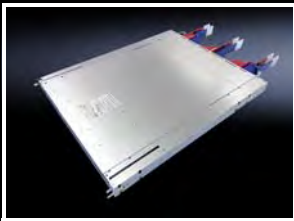

OCP Power Shelf

The power shelf connects the power supply to the busbar of the OCP rack, while at the same time functioning as a rack-mounted frame for the power supply units and the battery back-up units. Depending on the variant, a built-in controller is pre-fitted for monitoring the power supply.



Also required:

- OCP PDU, see page 872
- OCP Power Supply Unit, see page 873



Accessories:

- OCP Battery Back-up Unit, see page 873
- OCP Power Supply Unit, see page 873

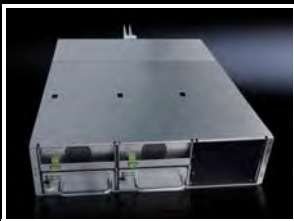

Design	Number of slots	Redundancy	Output voltage	Active power kW	Number of outputs	Height OU	Product-specific scope of supply	To fit Model No.	Packs of	Model No.
Shelf type: AC-DC	3 x PSU / 3 x UPS	2+1	12 V DC	6.6	1	3	–	7100.221	1 pc(s).	7100.921
Shelf type: AC/DC-DC	6 x PSU	3+3 / 5+1	12 V DC	18	3	1	Built-in controller	7100.200	1 pc(s).	7100.922
Shelf type: AC/DC-DC	6 x PSU	3+3 / 5+1	12 V DC	18	1	1	Built-in controller	7100.221	1 pc(s).	7100.923
Shelf type: AC/DC-DC	6 x PSU	3+3 / 5+1	48 V DC	24	1	1	Built-in controller	7100.200	1 pc(s).	7100.924
Shelf type: DC-DC	6 x PSU	3+3 / 5+1	12 V DC	15	1	1	Built-in controller	7100.221	1 pc(s).	7100.925
Blanking cover	–	–	–	–	–	1	–	7100.921	1 pc(s).	7100.961
Blanking cover	–	–	–	–	–	1	–	7100.921	1 pc(s).	7100.962

OCP Power Supply Unit

The power supply unit (PSU) is a power pack which centrally transforms the current or voltage in an OCP rack. The PSUs operate in parallel mode. A power shelf is needed for installation of the power supply units. Depending on the power shelf, up to 6 PSUs may be installed.

Benefits:

- May be connected with the system operational
- Parallel operation with active load distribution



Design	Input voltage	Output voltage	Active power kW	Power pack	To fit Model No.	Packs of	Model No.
Power Module PM	200 - 277 V AC	12.6 V DC	3.3	AC - DC	7100.921	1 pc(s).	7100.931
Power Module PM	90 - 300 V AC / 240 - 400 V DC	12.3 V DC	3	AC/DC - DC	7100.922/ 7100.923	1 pc(s).	7100.932
Power Module PM	90 - 300 V AC / 192 - 400 V DC	12.3 V DC	3.6	AC/DC - DC	7100.922/ 7100.923	1 pc(s).	7100.933
Power Module PM	200 - 277 V AC / 192 - 400 V DC	48 V DC	4	AC/DC - DC	7100.924	1 pc(s).	7100.934
Power Module PM	40 - 72 V DC	12.5 V DC	3	DC - DC	7100.925	1 pc(s).	7100.935
Blanking cover	-	-	-	-	7100.922/ 7100.923	1 pc(s).	7100.963

OCP Battery Back-up Unit

The battery back-up unit is an internal UPS in OCP architecture housed inside the rack, to ensure a controlled shutdown of the hardware and data backup in the event of a power failure.

Benefits:

- May be connected with the system operational
- Parallel operation with active load distribution



Design	Input voltage	Active power kW	To fit Model No.	Packs of	Model No.
Lithium ion battery back-up unit	52.5 V DC	3.6	7100.921	1 pc(s).	7100.951

Software for IT infrastructure

Configurators/Tools/CAD data

IT Infrastructure

Security, availability and efficiency are crucial to the productive operation of a data centre. This calls for a comprehensive approach which addresses all the relevant requirements as well as the peripheral conditions in order to devise a suitable solution. As well as personalised advice, Rittal can also provide you with a comprehensive range of tools for selecting, configuring and monitoring all relevant parameters.

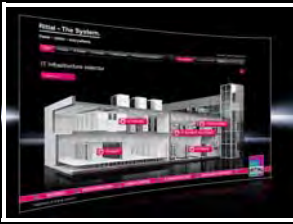

IT infrastructure selector

The selector supports you as partner, system integrator, system engineer or end customer in selecting the right IT products for your specific application.

Selector for:

- VX IT network/server enclosures
- Power Distribution Unit
- Liquid Cooling Package DX/CW
- Monitoring system CMC III
- Monitor/keyboard unit
- Fire alarm and extinguisher system DET-AC III

Benefits:

- All product segments in the data centre at a glance: Network/server racks, solutions for IT cooling, IT power and IT monitoring
- For added value, suitable accessories are suggested in every segment.
- The result is an individual IT infrastructure, ready for you to request a quote from Rittal.

Note:

- Use it online at www.rittal.com/it-configurator



RiMatrix S selector

Your selector for standardised data centres for SMEs, branch concepts and flexible cloud applications. Your solution is configured on the basis of standardised data centre modules.

Benefits:

- RiMatrix S at a glance
- Explanation of the option packages
- Efficiency calculation for your location
- As the outcome, you can save your compiled RiMatrix S solution as a PDF file.

Note:

- Use it online at www.rittal.com/configurators
- Download for free from the Google Play Store or App Store



Android app



iPhone app



Micro Data Center configurator

Configuration of your security safe, including a range of configuration components.

Benefits:

- Your complete micro data centre in just a few steps
- Individual selection of configuration components
- When you have finished, you can request a quote for your current configuration

Note:

- Configure online at www.rittal.com/mdc-configurator

Software for IT infrastructure

Configurators/Tools/CAD data

PDU configurator

Customise PDUs from the Rittal standard portfolio to suit your specific requirements. Assisted by the Rittal Configuration System (RICS), you can then visualise your configured solution directly during the selection process.

The modular concept:

- Adapt existing standard PDUs (built to order), delivery time up to 14 days
- Use a modular system comprised of individual system modules
- Wide range of accessories
- Additional modules, e.g. for overvoltage protection and for measuring differential current

Benefits:

- List and visualise your configuration
- Delivery times are shown transparently
- Get direct pricing information when you log into the online shop

Note:

- Use it online at www.rittal.com/configurators



IT cooling calculator

Simple selection of water-based Liquid Cooling Packages (LCP) for rack and suite cooling for your IT infrastructure.

Benefits:

- Calculation of the cooling output of LCPs
- Consideration of the various physical parameters
- Save your finished calculation as a PDF file

Note:

- Configure online at www.rittal.com/it-cc

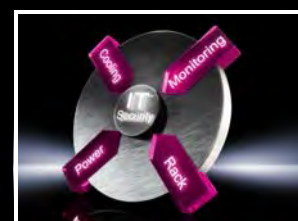

DCIM – Data Centre Infrastructure Management

RiZone – Perfect support of IT infrastructure components

- Customer-focused and cost-efficient
- Optimum monitoring of IT infrastructure components
- The physical data centre infrastructure (OT devices) is incorporated into a data centre infrastructure management system.
- RiZone supports SNMP V1/V2C and SNMP V3
- Simple configuration
- Automatic detection of Rittal components
- Workflow editor for user-defined scenarios
- Enhanced security and reliability
- Enhanced energy efficiency
- Integration of SNMP-compatible third-party equipment

Note:

- Detailed product description, see page 830

Rittal – The System.

Faster – better – everywhere.



SYSTEM ACCESSORIES

Base/plinth

Base/plinth system VX	880
Base/plinth system AX	888
Base/plinth	890

Base

Base	892
------------	-----

Walls

Side panels	901
Divider panels/partitions	904
Isolator door locking	909

Baying system

Baying	911
--------------	-----

Doors/locks

Door variants	917
Installation accessories for modular front design	925
Viewing windows/operating panels	929
Lock systems	933
Hinges	951
Door, internal	952

Roof/wall mounting

Roof	958
Wall mounting	965

Interior installation

Mounting plates	970
Rail systems	983
Assembly components	1001
Component shelves	1006
System lights	1014
EMC	1028
Interior installation for areas at risk of earthquakes	1031
Earthing	1033

Power supply

Socket strips	1040
---------------------	------

Cable management

Cable entry	1044
Gland plates	1049
Cable glands	1056
Cable routing inside the enclosure	1058
Cable routing 19"	1067

482.6 mm (19") installation system

Swing frames	1075
Accessories for Data Rack	1079
Mounting angles	1080
Slide rails	1086
482.6 mm (19") installation	1090
Splicing boxes	1099
Patch panels	1100
LSA connection system	1102

Human/machine interface

Handles	1103
External mounting accessories	1106
Front assembly	1107
Monitors	1109
Keyboards, supports and drawers	1110
Interfaces	1117
Signal pillars	1120

Technical information

Coating/spray-finishing	1128
Protection categories	1129



Base/plinth system VX – More efficiency

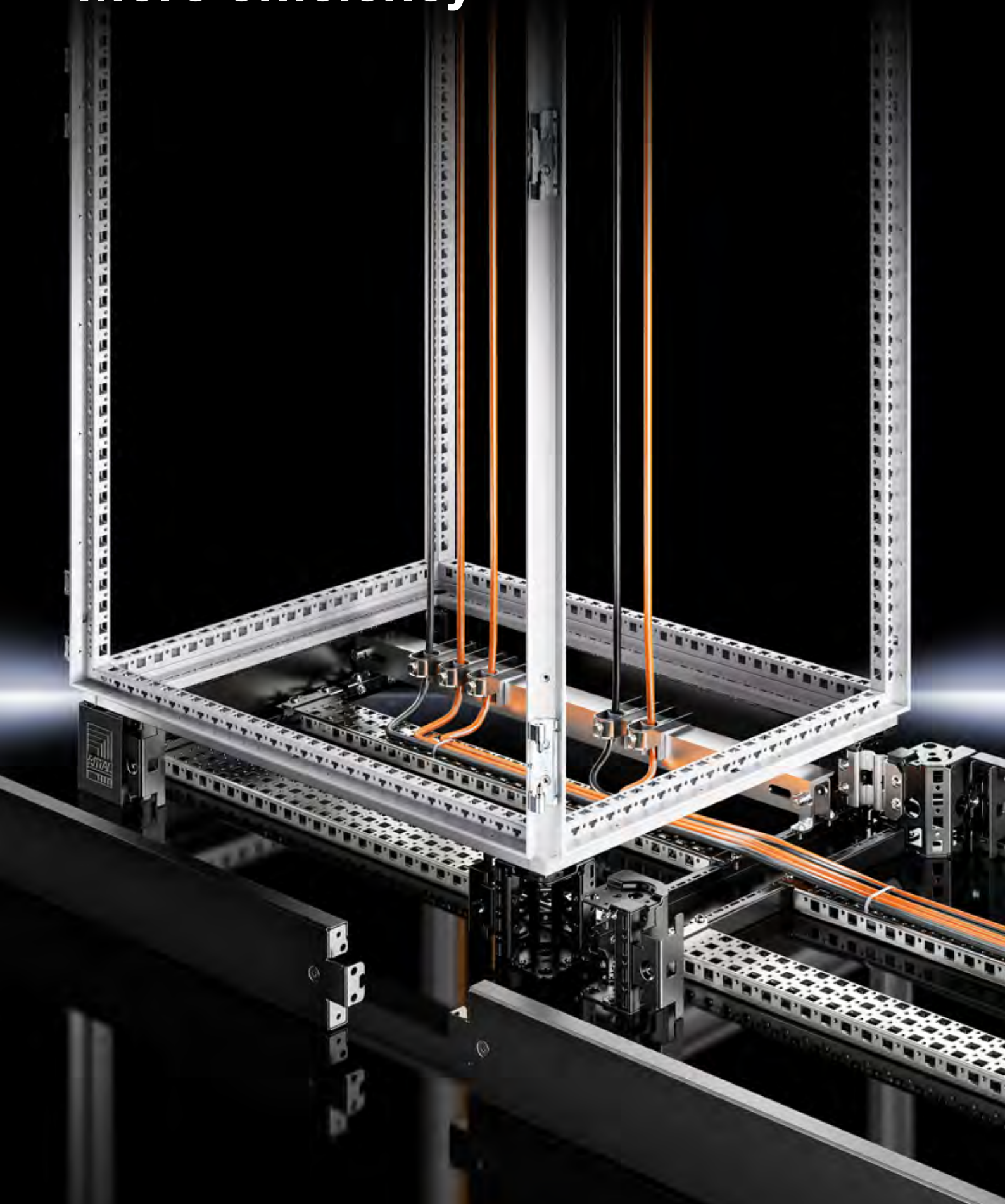

Integral centring aid

- The centring aid for base/plinth mounting on the enclosure frame ensures precise positioning of the enclosure on the base/plinth



Enclosure attachment

- The nuts integrated into the base/plinth corner piece allow screw-fastening directly from above, through the stable base frame, or from below, into the enclosure corner piece



Simple cable management

- Secure cable attachment and cable routing via the punched section with mounting flange in the base/plinth
- Gain space with simple integration of the cable clamping rail and C rail for secure, user-friendly cable routing



Base/plinth

Base/plinth system VX

Modular base/plinth diversity

The innovative base/plinth system VX offers an unprecedented diversity of functions and applications. It combines all existing base/plinth functions in a single solution, as well as opening up many new applications. As if that isn't enough, it is also compatible with existing enclosure solutions TS, TS IT, SE, PC and IW. In short, it is a base/plinth system.

The base/plinth system VX comprises the following components:

- Base/plinth corner pieces with base/plinth trim panels, front and rear
- Base/plinth trim panels, sides

Thanks to fully symmetrical corner pieces, and by using the same base/plinth trim panels in the width and depth, the system opens up many new applications. For example, the vented trim panels and trim panels with brush strips available as accessories may now optionally be attached at the sides, or exchanged for the front/rear trim panels.

All trim panels may optionally be clipped into the corner piece, or securely screw-fastened. Depending on the application, for example, users can dispense with the trim panels between bayed enclosure suites, or a 100 mm high trim panel may be used to stabilise the base/plinth corner pieces. In combination with its extensive range of accessories, the base/plinth system VX offers almost infinite possibilities in terms of siting, transportation, cable routing, cable attachment and base/plinth configuration.

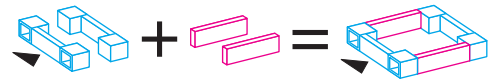

One Model No. for the **base/plinth corner pieces with base/plinth trim panels, front and rear**

One Model No. for the **base/plinth trim panels, sides**

One complete **base/plinth VX**

Base/plinth height	Basic form	Cable entry options				Stabilisation of bayed base/plinths
100 mm						
200 mm						

Configuration examples

Order includes	Functional benefits
3 packs Base/plinth corner pieces with base/plinth trim panels 1 pack Base/plinth trim panels, sides, 200 mm high	Continuous cable chamber
3 packs Base/plinth corner pieces with base/plinth trim panels 1 pack Base/plinth trim panels, sides, 200 mm high 1 pack Base/plinth trim panels, sides, 100 mm high 1 pack Baying brackets, internal (8617.500, packs of 6) 4 pc(s). are required for this solution	Additional stability during transportation with base/plinth trim panels rotated through 90°
3 packs Base/plinth corner pieces with base/plinth trim panels 2 packs Base/plinth trim panels, sides, 200 mm high	Shielding of the base/plinths from one another

Other options:

- Cable entry at the side by fitting a 100 mm base/plinth trim panel with brush strip
- Cable entry from the rear by dismantling one or more trim panels from the base/plinth corner pieces and replacing them with trim panels with brush strips
- Cable routing in the base/plinth by using punched sections with mounting flanges on the base/plinth trim panels

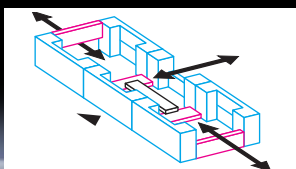
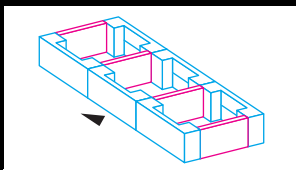
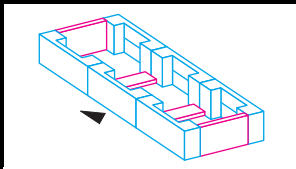
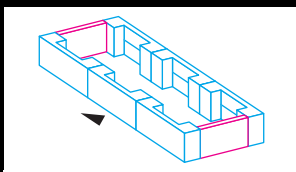

Base/plinth

Base/plinth system VX

Base/plinth corner pieces with base/plinth trim panels, front and rear

Sheet steel

for VX, VX IT, VX SE, TE, TopConsole, one-piece console, PC, IW

High-load capacity base/plinth corner pieces with moulded self-positioning to the enclosure, may be used with or without trim panels depending on the application. Large openings in the corner piece for optimum access to the screw-fastening point, may be concealed with a plastic corner and baying cover.

Material:

- Base/plinth corner piece: Sheet steel
- Base/plinth trim panel, front/rear: Sheet steel
- Corner and baying cover: Plastic

Colour:

- RAL 9005

100 mm high supply includes:

- 4 base/plinth corner pieces, 100 mm high
- 4 corner covers
- 1 baying cover
- 2 base/plinth trim panels, front/rear, 100 mm high
- Assembly parts

200 mm high supply includes:

- 4 base/plinth corner pieces, 200 mm high
- 4 corner covers
- 1 baying cover
- 1 base/plinth trim panel, front/rear, 200 mm high
- 2 base/plinth trim panels, front/rear, 100 mm high
- Assembly parts

100 mm high

For enclosure width mm	Model No.
300	8640.000
400	8640.001
600	8640.002
800	8640.003
850	8640.004
1000	8640.005
1100	8640.006
1200	8640.007
1600	8640.008
1800	8640.009

200 mm high

For enclosure width mm	Model No.
300	8640.020
400	8640.021
600	8640.022
800	8640.023
1000	8640.024
1200	8640.025
1600	8640.026
1800	8640.027



Also required:

- Base/plinth trim panels, sides, to finish off a unit, for additional stabilisation between base/plinths, or for interior configuration, see page 882



Accessories:

- Base/plinth trim panels with brush strip, see page 882
- Base/plinth trim panels, vented, see page 883
- Base/plinth installation bracket, see page 885
- Levelling component for base/plinth, see page 886
- Base mounting plate, see page 885
- Base/plinth adaptor for twin castors and levelling feet, see page 893
- Baying bracket, internal, see page 912
- Transport castors for base/plinth VX, see page 884
- C rails, see page 996

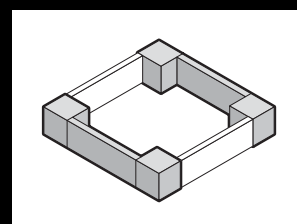

Base/plinth

Base/plinth system VX

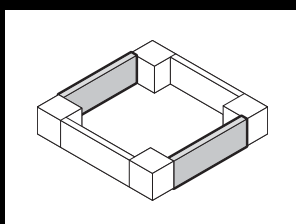

Base/plinth trim panels, sides

Sheet steel for base/plinth VX

To finish off a base/plinth unit at the sides and for additional stabilisation or for the interior configuration of bayed base/plinths. One 200 mm high or two 100 mm high trim panels may optionally be fitted on 200 mm high base/plinths.

Material:

- Sheet steel

Colour:

- RAL 9005

Supply includes:

- 2 base/plinth trim panels
- Assembly parts

100 mm high

For enclosure depth mm	Model No.
300	8640.030
400	8640.031
500	8640.032
600	8640.033
800	8640.034
1000	8640.035
1200	8640.036

200 mm high

For enclosure depth mm	Model No.
300	8640.040
400	8640.041
500	8640.042
600	8640.043
800	8640.044
1000	8640.045
1200	8640.046



Accessories:

- Base/plinth installation bracket, see page 885



Possible alternative:

- Base/plinth trim panels with brush strip, see page 882
- Base/plinth trim panels, vented, see page 883

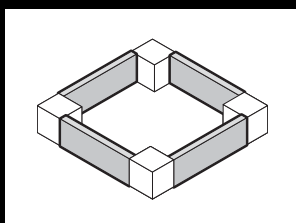

Base/plinth trim panels with brush strip

Sheet steel for base/plinth VX

For cable entry in the base/plinth. With a base/plinth height of 200 mm, one or two trim panels with brush strips may optionally be used. Thanks to the complete symmetry of the base/plinth system VX, the trim panels with brush strip may either be fitted at the front, rear or side on the base/plinth corner piece.

Material:

- Base/plinth trim panels: Sheet steel
- Brush strip: Plastic, self-extinguishing

Colour:

- RAL 9005

Supply includes:

- 2 base/plinth trim panels with brush strip
- Assembly parts

For enclosure width/depth mm	Model No.
600	8620.092
800	8620.093
1000	8620.094
1200	8620.095

Base/plinth

Base/plinth system VX

Base/plinth trim panels, vented

Sheet steel for base/plinth VX

For venting the enclosure via the base/plinth. Specifically in applications such as power distribution where the enclosure gland plates are not used, this can be used to achieve a higher air throughput inside the enclosure. Various solutions to raise the roof and special roof plates with vent openings are also available for enclosure venting. With a 200 mm base/plinth height, one or two vented trim panels may optionally be used. Thanks to the complete symmetry of the base/plinth system VX, the vented trim panels may either be fitted at the front, rear or side on the base/plinth corner piece.

Material:

- Sheet steel

Colour:

- RAL 9005

Supply includes:

- 2 base/plinth trim panels, vented
- Assembly parts for mounting on the base/plinth corner piece

For enclosure width/depth mm	Model No.
600	8620.090
800	8620.091

+ Accessories:

- Filter mat, see page 883
- Base/plinth installation bracket, see page 885
- Spacers for lifting the roof, see page 964
- Roof plate with vent holes, see page 961

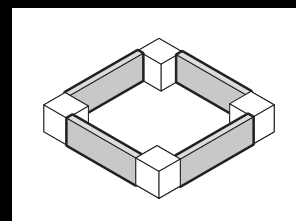

Filter mat

for base/plinth trim panel, vented

The filter mat is simply inserted into the trim panel from the rear.

Supply includes:

- 1 pack = 2 rolls, length 2 m each, may be shortened to required length

Packs of	Model No.
1 pc(s).	8620.100



Baying cover

for VX base/plinth

To neatly close the gap between two bayed base/plinths and it is required to close the gap at the rear when baying three or more base/plinths.

Material:

- Plastic ABS, halogen-free

Colour:

- RAL 9005

Note:

- A baying cover is already included as standard with the supply of base/plinth corner pieces with base/plinth trim panels, front and rear

Height mm	Packs of	Model No.
100	10 pc(s).	8620.010
200	10 pc(s).	8620.011

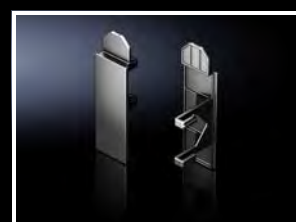

Base/plinth

Base/plinth system VX



Cable chamber

for VX, VX SE

With integral system punchings for individual system accessories.

Height: 200 mm

Material:

- Sheet steel

Colour:

- RAL 7035

Supply includes:

- 1 frame
- 2 trim panels front/rear
- Assembly parts for mounting on the enclosure

For enclosures		Packs of	Model No.
Width mm	Depth mm		
400	500	1 pc(s).	8600.455
400	600	1 pc(s).	8600.465
600	500	1 pc(s).	8600.655
600	600	1 pc(s).	8600.665
800	500	1 pc(s).	8600.855
800	600	1 pc(s).	8600.865
1200	500	1 pc(s).	8600.255
1200	600	1 pc(s).	8600.265

+ Accessories:

- Side panels for cable chamber, see page 884



Side panel

for cable chamber

Height: 200 mm

Material:

- Sheet steel

Colour:

- RAL 7035

Supply includes:

- 2 side panels
- Assembly parts

For enclosure depth mm	Packs of	Model No.
500	2 pc(s).	8600.510
600	2 pc(s).	8600.520



Transport castors

for VX base/plinth

For locating onto the base/plinth corner piece, 100 or 200 mm high.

Load capacity:

- Maximum permissible load per twin castor: 750 N

Colour:

- RAL 9005

Supply includes:

- 4 twin castors, 2 x with, 2 x without locks

Floor clearance mm	Model No.
100	8100.700

+ Accessories:

- Base/plinth trim panels, sides, sheet, for stabilisation, see page 882
- Base/plinth trim panels, sides, stainless steel, for stabilisation, see page 887

Base/plinth

Base/plinth system VX

Base mounting plate

for base/plinth VX, base/plinth AX and base/plinth, complete

For attaching the base/plinth to the floor.
For assembly screws up to 12 mm Ø.

Material:

– Sheet steel

Surface finish:

– Zinc-plated

Packs of	Model No.
10 pc(s).	2817.000



Base/plinth installation bracket

for VX base/plinth

For configuring the base/plinth with punched sections with mounting flanges or cable clamp rails.
To fit 100 and 200 mm high base/plinth trim panels in sheet steel and stainless steel.

Material:

– Stainless steel 1.4301 (AISI 304)

Supply includes:

- 2 installation brackets
- 2 mounting brackets for cable clamp rail
- Assembly parts

Note:

- For interior installation on upright base/plinth trim panels
- For base/plinth trim panels rotated through 90°, the installation bracket is not needed, because in this position, the system punchings of the base/plinth trim panels may be used directly

For base/plinth trim panel Height mm	Packs of	Model No.
100	2 pc(s).	8620.400
200	2 pc(s).	



Accessories:

- Punched section with mounting flange, 23 x 64 mm, see page 991
- Punched section with mounting flange, 23 x 89 mm, see page 991
- Cable clamp rail, see page 1059



- 1 Installation bracket with mounting bracket for cable clamp rail
- 2 Cable clamp rail
- 3 Installation bracket
- 4 Punched section with mounting flange, 23 x 89 mm
- 5 Base/plinth trim panel, rotated through 90°

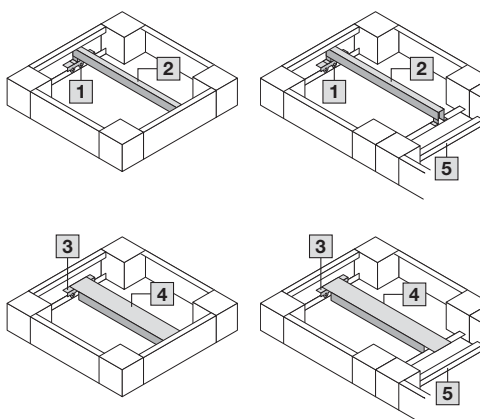

Base/plinth

Base/plinth system VX

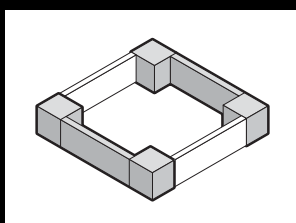

Levelling component

for VX base/plinth

For retrospective levelling on uneven floors at the installation site up to a maximum of 15 mm. Installed through the base/plinth corner piece. Adjusted using a hex spanner, width across flats 19 mm.

Benefits:

- A door offset caused by uneven flooring can be corrected
- Installed on the assembled enclosure, i.e. no need to plan levelling in advance

Load capacity:

- Max. admissible load: 2500 N per levelling component (check the load capacity of the floor)

Supply includes:

- Assembly parts

For base/plinth height mm	Packs of	Model No.
100	4 pc(s).	8100.710
200	4 pc(s).	8100.711

Base/plinth corner pieces with base/plinth trim panels, front and rear

Stainless steel for VX, VX SE, PC

High-load capacity base/plinth corner pieces with moulded self-positioning to the enclosure, may be used with or without trim panels depending on the application. Large openings in the corner piece for optimum access to the screw-fastening point, may be concealed with a plastic corner and baying cover.

Material:

- Base/plinth corner piece: Stainless steel 1.4301 (AISI 304)
- Base/plinth trim panel, front/rear: Stainless steel 1.4301 (AISI 304 steel)
- Corner and baying cover: Plastic

Surface finish:

- Trim panel: Grain size 400

100 mm high supply includes:

- 4 base/plinth corner pieces, 100 mm high
- 4 corner covers
- 1 baying cover
- 2 base/plinth trim panels, front/rear, 100 mm high
- Assembly parts

200 mm high supply includes:

- 4 base/plinth corner pieces, 200 mm high
- 4 corner covers
- 1 baying cover
- 1 base/plinth trim panel, front/rear, 200 mm high
- 2 base/plinth trim panels, front/rear, 100 mm high
- Assembly parts

For enclosure width mm	Height mm	Model No.
600	100	8620.050
800	100	8620.051
1000	100	8620.052
1200	100	8620.053
600	200	8620.060
800	200	8620.061
1000	200	8620.062
1200	200	8620.063



Also required:

- Base/plinth trim panels, sides, to finish off a unit, for additional stabilisation between base/plinths, or for interior configuration, see page 887



Accessories:

- Base/plinth installation bracket, see page 885
- Levelling component for base/plinth, see page 886
- Base mounting plate, see page 885
- Base/plinth adaptor for twin castors and levelling feet, see page 893
- Transport castors for base/plinth, see page 884
- C rails, see page 996

Base/plinth

Base/plinth system VX

Base/plinth trim panels, sides

Stainless steel for base/plinth VX

To finish off a base/plinth unit at the sides and for additional stabilisation or for the interior configuration of bayed base/plinths. One 200 mm high or two 100 mm high trim panels may optionally be fitted on 200 mm high base/plinths.

Material:

- Stainless steel 1.4301 (AISI 304)

Surface finish:

- Brushed, grain size 400

Supply includes:

- 2 base/plinth trim panels
- Assembly parts

For enclosure depth mm	Height mm	Model No.
400	100	8620.070
500	100	8620.071
600	100	8620.072
400	200	8620.080
500	200	8620.081
600	200	8620.082



Accessories:

- Base/plinth installation bracket, see page 885

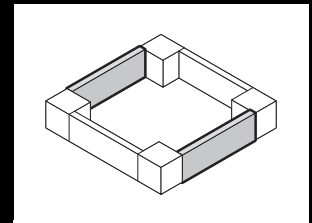
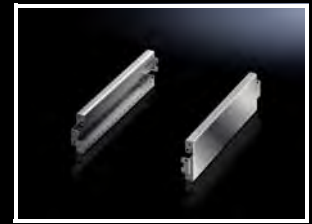

Base/plinth

Base/plinth system AX

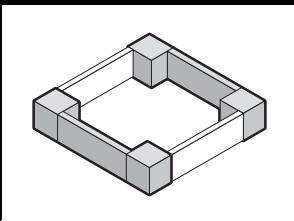

Modular base/plinth diversity

The innovative base/plinth system AX offers an unprecedented diversity of functions and applications.

The base/plinth system AX comprises the following components:

- Base/plinth corner pieces with base/plinth trim panels, front and rear
- Base/plinth trim panels, sides

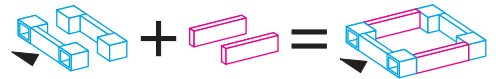

One Model No. for the **base/plinth corner pieces with base/plinth trim panels, front and rear**

One Model No. for the **base/plinth trim panels, sides**

One complete **base/plinth AX**

Base/plinth height	Basic form	Cable entry options				Stabilisation of bayed base/plinths	
100 mm							
200 mm							

Base/plinth corner pieces with base/plinth trim panels, front and rear

Sheet steel for AX, AX IT

Base/plinth corner pieces with large opening for optimum access to the screw-fastening point, may be concealed with a plastic corner cover.

Material:

- Base/plinth corner piece: Sheet steel
- Base/plinth trim panel, front/rear: Sheet steel
- Corner cover: Plastic

Colour:

- RAL 9005

100 mm high supply includes:

- 4 base/plinth corner pieces, 100 mm high
- 4 corner covers
- 2 base/plinth trim panels, front/rear, 100 mm high
- Assembly parts

200 mm high supply includes:

- 4 base/plinth corner pieces, 200 mm high
- 4 corner covers
- 1 base/plinth trim panel, front/rear, 200 mm high
- 2 base/plinth trim panels, front/rear, 100 mm high
- Assembly parts

100 mm high

For enclosure width mm	Model No.
600	2820.061
800	2820.081
1000	2820.101
1200	2820.121

200 mm high

For enclosure width mm	Model No.
600	2820.062
800	2820.082
1000	2820.102
1200	2820.122



Also required:

- Side base/plinth trim panels, to finish off a base/plinth unit at the end or for interior configuration of the base/plinth, see page 889



Accessories:

- Base mounting plate, see page 885

Base/plinth

Base/plinth system AX

Base/plinth trim panel, sides

Sheet steel for base/plinth AX

To finish off a base/plinth unit at the sides or for the interior configuration of the base/plinth. One 200 mm high or two 100 mm high trim panels may optionally be fitted on 200 mm high base/plinths.

Material:

- Sheet steel

Colour:

- RAL 9005

Supply includes:

- 2 base/plinth trim panels
- Assembly parts

100 mm high

For enclosure depth mm	Model No.
300	2820.310
400	2820.410

200 mm high

For enclosure depth mm	Model No.
300	2820.320
400	2820.420

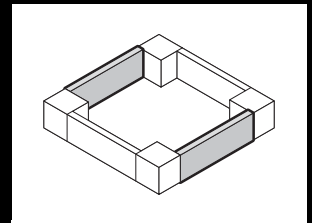

Base/plinth

Base/plinth

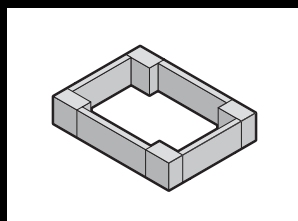
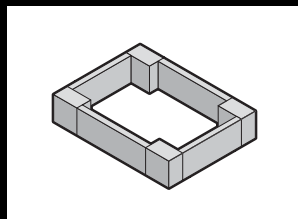
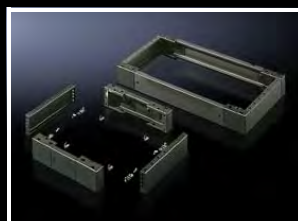

Base/plinth, complete

Sheet steel for TP universal console

Trim panels, front and rear with fitted corner pieces and side trim panels.

Height: 100 mm

Material:

- Sheet steel

Surface finish:

- Spray-finished

Colour:

- RAL 7022

Supply includes:

- 4 corner pieces
- 2 trim panels, front/rear
- 2 trim panels, side
- Mounting accessories for mounting on the enclosure

For consoles		Base/plinth depth mm	Model No.
Width mm	Depth mm		
600	500	450	2807.200

+ Accessories:

- Fastening bolt, see page 891
- Base mounting plate, see page 885

Base/plinth, complete

Stainless steel for one-piece console, stainless steel

Height: 100 mm

Where necessary, 2 base/plinths may be installed one above the other.

Material:

- Stainless steel 1.4301 (AISI 304)

Surface finish:

- Brushed

Supply includes:

- 2 trim panels, front/rear
- 2 trim panels, side
- Mounting accessories for mounting on the enclosure

For enclosures / consoles		Model No.
Width mm	Depth mm	
600	400	2865.000
800	400	2869.000
1000	400	2867.000
1200	400	2870.000

+ Accessories:

- Levelling feet HD, see page 223

Base/plinth, static

for PC, IW

Design-coordinated with the enclosures, height 100 mm, with front projection.

Material:

- Sheet steel, 2.0 mm

Colour:

- RAL 7035
- Design component, front: RAL 7015

Supply includes:

- 1 design component, front
- 1 base/plinth component, rear
- 2 base/plinth trim panels, side

For depth mm	Packs of	Model No.
600	1 pc(s).	8800.920

+ Accessories:

- Twin castors 7495.000, see page 893
- Levelling feet 4612.000, see page 892
- Fastening bolt 2819.000, see page 891

Base/plinth

Base/plinth

Fastening bolts

for base/plinth, complete and base/plinth, static

For mounting on base/plinth trim panels, side. The lockable fastening bolt allows the installation of cable clamp rails. Tighten with hex spanner, width across flats 19 mm.

Material:

– Hexagonal steel

Surface finish:

– Zinc-plated

For base/plinth trim panel Height mm	Packs of	Model No.
100	10 pc(s).	2819.000
200	10 pc(s).	2819.200



Accessories:

– Cable clamp rail, see page 1059

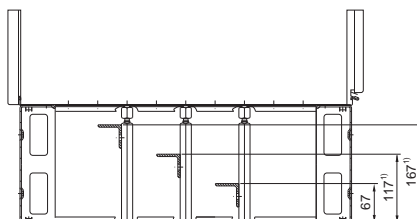

¹⁾ Only for height 200 mm

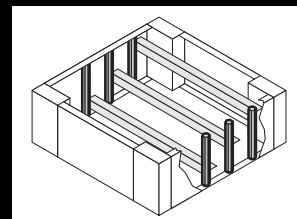

Cross member

adjustable for VX, VX SE, TP, PC, IW

To increase stability, adjustable to the enclosure depth.

Height: 70 mm

To increase stability, the cross member is positioned below the base frame of the enclosure and protrudes 138 mm at the front and rear. For deeper enclosures, the rear part may be extended and screw-fastened again. For screw-fastening to the floor and enclosure with mounting hole at the sides, front and rear. The castors and levelling feet may be secured to the welded nuts M12.

Material:

– Sheet steel

Surface finish:

– Spray-finished

Colour:

– RAL 7015

For enclosure depth mm	Model No.
400	8601.450
500	
600	8601.680
800	



Accessories:

– Twin castors 6148.000, 7495.000, see page 893
– Levelling feet 4612.000, see page 892



Assembly instruction:

– Ensure sufficient stability to prevent the enclosure from tipping over



Base/plinth

for FlatBox

For attachment purposes, the base/plinth may be mounted on the pre-existing thread in the base area of the FlatBox. There is a rear recess provided for cable entry.

Material:

– Sheet steel

Surface finish:

– Powder-coated

Colour:

– RAL 7035

Supply includes:

– 4 levelling feet
– Assembly parts

For base area		Height mm	Packs of	Model No.
Width mm	Depth mm			
600	600	50	1 pc(s).	7507.750
700	700	50	1 pc(s).	7507.755

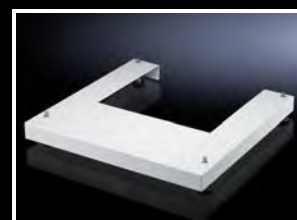

Base

Base



Levelling feet

for VX, VX IT, VX SE, PC, IW

To compensate for height differences with floor irregularities. Mounting thread M12.

Load capacity:

- Max. admissible load: approx. 3000 N per levelling foot

For enclosure	Levelling range mm	Packs of	Model No.
Sheet steel	18 – 43	4 pc(s).	4612.000
Stainless steel	55 – 125	4 pc(s).	8100.780



Also required:

- For mounting on the base/plinth:
Base/plinth adaptor, see page 893



Levelling feet

with internal adjustment, for VX IT

To compensate for floor irregularities. When used in the mounting bracket, the levelling feet are moved inwards to allow convenient operation from inside the enclosure so that the enclosure is easily levelled, even retrospectively.

Load capacity:

- Max. admissible static load: 6500 N per levelling foot

Supply includes:

- 4 levelling feet, M12, with TX30 hex socket drive
- 4 mounting brackets
- Assembly parts

Packs of	Model No.
4 pc(s).	5301.326

Note:

- Use levelling foot 4612.000 and base/plinth adaptor 8100.770 for mounting on the VX base/plinth



Levelling feet

for FlatBox M10 x 20 mm

For screw-fastening onto the enclosure base when used as a floor-standing or desktop enclosure. Width across flats 17, mounting thread multi-tooth 30.

Load capacity:

- Max. admissible static load:
5500 N per levelling foot
700 N per enclosure

Packs of	Model No.
4 pc(s).	7507.740

Levelling feet

for VX, VX SE, PC
85 – 115 mm high

For mounting on enclosures, for easier floor cleaning and to compensate for floor irregularities ±15 mm.

Load capacity:

- Max. admissible load: 3,500 N per levelling foot

Material:

- Stainless steel 1.4301 (AISI 304)

Supply includes:

- Assembly parts

Packs of	Model No.
4 pc(s).	2859.000



Twin castors

Mounting thread M12 x 20.

For:

- Baying enclosure system VX
- Network/server racks VX IT
- Free-standing enclosure system VX SE
- PC enclosure system
- Pedestal base plate
- Pedestal 6106.200/6106.300
- TopConsole pedestals
- Industrial Workstation
- Data Rack

Supply includes:

- Packs of 4 twin castors, 2 x with, 2 x without locks
- Assembly parts

	Maximum admissible static load (per castor)	75 kg
1	Floor clearance	85 mm
	Colour	Black with grey running surface
	Model No.	6148.000

	Maximum admissible static load (per castor)	120 kg
2	Floor clearance	125 mm
	Colour	Black
	Model No.	7495.000

Note:

For mounting on the VX base/plinth, only twin castors 7495.000 may be used in combination with the base/plinth adaptor for twin castors, see page 893



Base/plinth adaptor

for twin castors and levelling feet

For mounting twin castors and levelling feet to the base/plinth.

Material	Packs of	Model No.
Sheet steel	4 pc(s).	8100.770
	4 pc(s).	8100.771



Also required:

- When fitting twin castors, side trim panels, see page 882/887, are required.

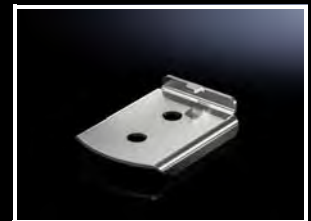

Base

Base



Transport kit

for VX, VX IT empty enclosures

To easily transport empty enclosures to the point of use.

Load capacity:

- Max. static load: 2,000 N per set of castors, including enclosure

Supply includes:

- 4 castors
- 4 mounting brackets
- Assembly parts

Packs of	Model No.
1 pc(s).	5301.515

Assembly instruction:

- The base area must be open at the mounting points



Castor module

for VX, VX IT

For mobile use even with preconfigured enclosures. The castor module is screw-fastened to the structure directly underneath the base frame and is suitable for transporting configured enclosures on flat ground and inside buildings. The castor modules already have pre-integrated levelling feet, allowing the enclosure to be levelled directly on site at the point of installation. The castor module can remain underneath the enclosure.

Load capacity:

- Max. admissible load: Static 15,000 N
- Max. admissible load: Dynamic 10,000 N

Supply includes:

- 1 transport module with 2 castors
- 1 transport module with 2 castors, fixed
- Assembly parts

For enclosure width mm	Packs of	Model No.
600	2 pc(s).	5301.516
800	2 pc(s).	5301.518

Note:

- The maximum admissible load capacity (dynamic) of 10,000 N refers to rolling over flat ground

Assembly instruction:

- The base area must be open at the mounting points



Stabiliser

for VX IT

If required, the optional stabiliser for the VX IT may be retrofitted in situ at any time. With the front door open, simply snap onto the vertical sections of the enclosure frame and level to match the enclosure height. This enlarges the enclosure's footprint and makes it less likely to tip over when installed components are withdrawn from the enclosure or fitted in the front. It can be used as an alternative if the enclosures cannot be screw-fastened to the floor or secured in an enclosure suite. After installation, simply remove the stabiliser again. The stabiliser may be used on the enclosure frame without bottom-mounting and in combination with levelling feet or a base/plinth up to 200 mm high. The striking signal-red spray-finish draws attention to this trip hazard.

Packs of	Model No.
2 pc(s).	5301.325

Load capacity:

- Max. extension weight: 200 kg, point of gravity 250 mm from the enclosure front

Material:

- Sheet steel, spray finished in RAL 3001 (signal red)

Supply includes:

- 2 levelling stabilisers with fast, tool-free installation

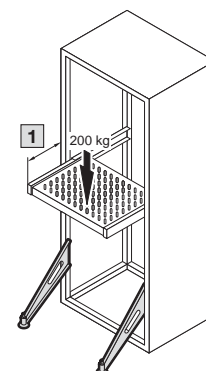

- 1** Max. distance to the front edge of the enclosure 250 mm

Transport castors

for TE

The castors may be screw-fastened in the corner areas of the base frame in place of the levelling feet. Floor clearance: 58 mm, mounting thread M10 x 20

Supply includes:

- Assembly parts

Max. load capacity (static) per enclosure N	Packs of	Model No.
3000	4 pc(s).	7000.672



System divider

for VX, VX SE

Divides the enclosure width into two zones. For example, this allows mounting plates, cable clamp rails or swing frames from 600 mm wide enclosures to be fitted in 1200 mm wide enclosures.

Material:

- Sheet steel

Surface finish:

- Zinc-plated

Supply includes:

- Assembly parts

Depth mm	Packs of	Model No.
500	2 pc(s).	8620.900
600	2 pc(s).	8620.901



Accessories:

- Swing frame mounting kit, see page 1078
- Cable clamp rail, see page 1059
- Support rails 48 x 26 mm, see page 996

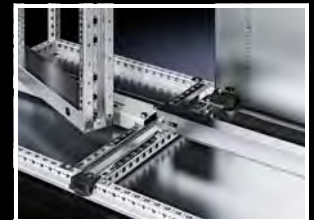
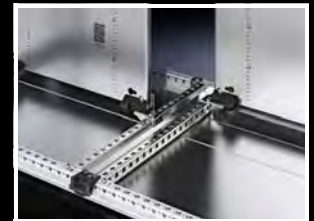

Base

Base

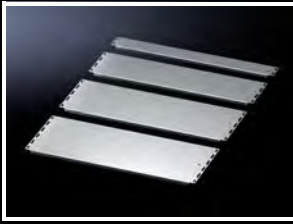

Gland plates

for VX, VX IT, VX SE

For individual configuration of the floor space. Potential equalisation is provided via assembly components and earthing points.

Material:

- Sheet steel

Surface finish:

- Zinc-plated

Supply includes:

- Assembly parts

Note:

- At least one sliding plate is required to fully seal a base opening
- For two-door enclosures, one pack is sufficient for one half of the enclosure

Example with enclosure depth 600 mm

T1 (600 mm) - 148 = T2 (452 mm)

1 Sliding plate

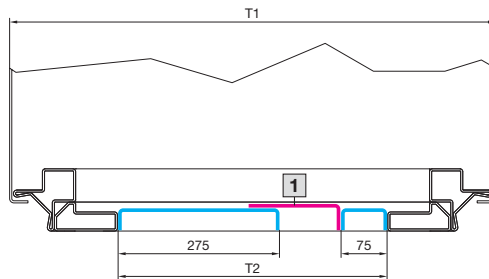

Accessories:

- Sliding plate, see page 896

For enclosure width 600 mm

Depth mm	Packs of	Model No.
75	1 pc(s).	8001.210
175	1 pc(s).	8001.214
237.5	1 pc(s).	8001.218
275	1 pc(s).	8001.222

For enclosure width 800 mm

Depth mm	Packs of	Model No.
75	1 pc(s).	8001.211
175	1 pc(s).	8001.215
237.5	1 pc(s).	8001.219
275	1 pc(s).	8001.223

For enclosure width 1000 mm

Depth mm	Packs of	Model No.
75	1 pc(s).	8001.212
175	1 pc(s).	8001.216
237.5	1 pc(s).	8001.220
275	1 pc(s).	8001.224

For enclosure width 1200 mm

Depth mm	Packs of	Model No.
75	1 pc(s).	8001.213
175	1 pc(s).	8001.217
237.5	1 pc(s).	8001.221
275	1 pc(s).	8001.225



Sliding plate

for VX, VX IT, VX SE

For variable compensation as well as a flexible opening in the base area. May be combined with gland plates.

Sliding plate depth:

- 65 - 115 mm

Material:

- Sheet steel

Surface finish:

- Zinc-plated

Supply includes:

- Assembly parts

For enclosure width mm	Packs of	Model No.
600	1 pc(s).	8001.239
800	1 pc(s).	8001.241
1000	1 pc(s).	8001.242
1200	1 pc(s).	8001.243

Gland plate set, multi-piece, solid

for VX IT

Multi-piece gland plate set consisting of solid base plate modules and a sliding plate for cable entry. The solid gland plate module, depth 237.5 mm, may optionally be exchanged for gland plate module variants for cable entry.

Benefit:

- The sequence of individual modules may be freely selected

Material:

- Sheet steel

Surface finish:

- Zinc-plated

Supply includes:

- Gland plate set
- Sealing tape
- Assembly parts

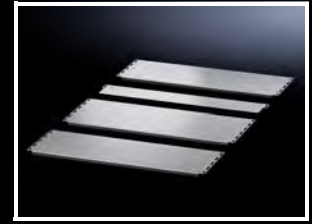

For enclosure width mm	For enclosure depth mm	Gland plate module, solid				Sliding plate depth 115 mm	Packs of	Model No.
		Depth 75 mm	Depth 175 mm	Depth 237.5 mm	Depth 275 mm			
600	1000	-	-	2	1	1	1 pc(s).	5301.338
600	1200	-	-	4	-	1	1 pc(s).	5301.341
800	600	1	1	-	-	2	1 pc(s).	5301.336
800	800	1	-	2	-	1	1 pc(s).	5301.337
800	1000	-	-	2	1	1	1 pc(s).	5301.344
800	1200	-	-	4	-	1	1 pc(s).	5301.347

Gland plate module, vented

for VX IT

For closing the base

Benefit:

- Large perforated section to support passive climate control of the enclosure
- Filter mat slides in from above for easy replacement

Gland plate depth:

- 237.5 mm

Material:

- Sheet steel

Surface finish:

- Zinc-plated

Supply includes:

- Gland plate module, vented
- Filter mat
- Assembly parts

For enclosure width mm	Packs of	Model No.
600	1 pc(s).	5301.330
800	1 pc(s).	5301.331



Assembly instruction:

- Several gland module plates must be combined to seal the base completely in the VX IT
- The gland plate module may be combined in exchange with other base modules with a depth of 237.5 mm



Gland plate module, one-piece, with brush strip

for VX IT

For targeted cable entry from below.

Gland plate depth:

- 237.5 mm

Material:

- Module plate: Sheet steel
- Brush strip: Plastic, UL 94 HB, halogen-free

Surface finish:

- Module plate: Zinc-plated

Supply includes:

- Assembly parts

For enclosure width mm	Packs of	Model No.
600	1 pc(s).	5301.332
800	1 pc(s).	5301.333

Note:

- Gland plate modules with brush strip not suitable for applications with a protection category to IEC 60 529



Assembly instruction:

- Several gland module plates must be combined to seal the base completely in the VX IT
- The gland plate module may be combined in exchange with other base modules with a depth of 237.5 mm

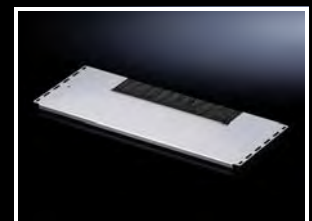

Base

Base



Gland plate module, multi-piece, with brush strip, super-airtight

for VX IT

For targeted cable entry from below. With correct cable entry, special brush strips with alternating off-set brushes provide a more effective seal from the environment to support climate control. The two-piece design even allows retrospective fitting of the base module with the cables already installed.

Gland plate depth:

- 237.5 mm

Material:

- Module plate: Sheet steel
- Brush strip: Plastic, UL 94 HB, halogen-free

Surface finish:

- Module plate: Zinc-plated

Supply includes:

- Assembly parts

For enclosure width mm	Packs of	Model No.
600	1 pc(s).	5301.334
800	1 pc(s).	5301.335

Note:

- Gland plate modules with brush strip not suitable for applications with a protection category to IEC 60 529



Assembly instruction:

- Several gland module plates must be combined to seal the base completely in the VX IT
- The gland plate module may be combined in exchange with other base modules with a depth of 237.5 mm.

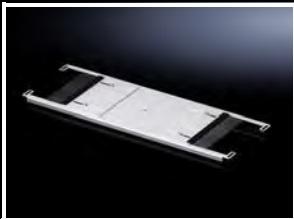

Gland plate module for side cable entry

for VX IT

With adjustable opening and brush strips on both sides. The version which is open at the side even allows the base plate module to be retro-fitted with the cables already installed.

Gland plate depth:

- 237.5 mm

Material:

- Module plate: Sheet steel
- Brush strip: Plastic, UL 94 HB, halogen-free

Surface finish:

- Module plate: Zinc-plated

Supply includes:

- Assembly parts

For enclosure width mm	Packs of	Model No.
800	1 pc(s).	5301.348

Note:

- Gland plate modules with brush strip not suitable for applications with a protection category to IEC 60 529



Assembly instruction:

- Several gland module plates must be combined to seal the base completely in the VX IT
- The gland plate module may be combined in exchange with other base modules with a depth of 237.5 mm.

Module plates

for TE

The base area of the TE may be varied as required using the module plates.

Material:

- Sheet steel

Surface finish:

- Zinc-plated

Supply includes:

- Assembly parts

Compensating panel design

Width B1 mm	Depth T1 mm	For enclosure width mm	Model No.
450	50	600	7526.750
450	150	600	7526.755
650	50	800	7526.790
650	150	800	7526.795

Vented design

Width B1 mm	Depth T1 mm	For enclosure width mm	Model No.
450	200	600	7526.829
650	200	800	7526.834

Solid design

Width B1 mm	Depth T1 mm	For enclosure width mm	Model No.
450	200	600	7526.760
450	550	600	7526.770
450	750	600	7526.780
650	200	800	7526.800
650	550	800	7526.785
650	750	800	7526.820

Design with brush strip

Width B1 mm	Depth T1 mm	For enclosure width mm	Model No.
450	200	600	7526.850
650	200	800	7526.860

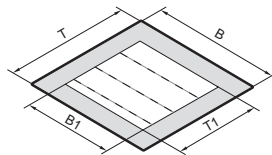

Please note the following when selecting suitable module plates:

B1 = Enclosure width (B) - 150 mm

T1 = Enclosure depth (T) - 50 mm

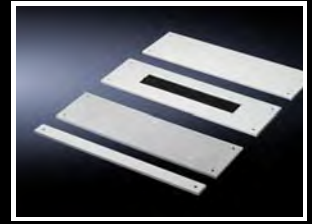

Base

Base



Base mounting bracket

for VX, VX IT

To anchor the enclosure to the floor, particularly if it is top-heavy and inclined to tilt or cannot be incorporated into a suite of enclosures.

Material:

- Sheet steel, zinc-plated

Supply includes:

- Assembly parts

Packs of	Model No.
2 pc(s).	5301.350

Assembly instruction:

- The base area must be open at the mounting points
- Additional holes in the false base are required for mounting
- The assembly parts for connecting the enclosure to the substructure will vary according to its specific properties and are not included with the supply

Pressure relief stopper

Especially when enclosures are exposed to changing climatic conditions, pressure differences may cause condensation to form in sealed enclosures. The integral sealing membrane in the pressure relief stopper largely prevents such pressure differences and hence eliminates condensation; additionally, it also prevents the ingress of moisture from the outside.

Installed in vertical surfaces to protect against dirt.

Technical specifications:

- Air permeability up to 120 litres/hour with a pressure difference of 70 mbar
- Connection thread M12 x 1.5
- For fitting in wall thicknesses up to 4 mm

Packs of	Model No.
5 pc(s).	2459.500

Material:

- Polyamide

Colour:

- Similar to RAL 9005

Protection category IP to IEC 60 529:

- IP X8

Protection category IP to DIN 40 040-9:

- IP 69K

Supply includes:

- Lock nut

Condensate discharge

For reliable condensate discharge from the inside and protection against splashed water from the outside (labyrinth effect). A hole diameter of 16 mm is required (with AX sheet steel, the holes are already provided in the base).

Material:

- Polyamide

Colour:

- Similar to RAL 7035

Protection category:

- Protection from splashed water, when correctly installed at the bottom

Packs of	Model No.
6 pc(s).	2459.000

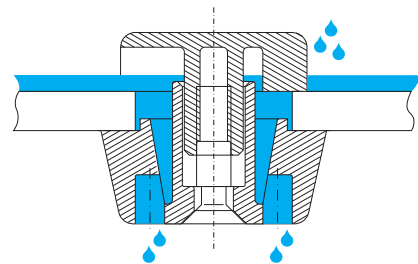

Side panel, screw-fastened, sheet steel

for VX, VX IT

- Time-saving assembly thanks to clip-in side panel holders
- Automatic potential equalisation and higher EMC protection, thanks to enclosure panel holders with earthing inserts located on the inside
- Easy positioning in the height and depth with the location aid
- Simple assembly
- Earthing bolts with large, paint-free contact surface for optimum contact

Material:

- Sheet steel, 1.5 mm

Surface finish:

- Dipcoat-primed, powder-coated on the outside

Colour:

- RAL 7035

Protection category IP to IEC 60 529:

- IP 55 (in conjunction with enclosures from the VX, VX IT series)

Protection category NEMA:

- NEMA 12 (in conjunction with enclosures from the VX, VX IT series)

Supply includes:

- Assembly parts

For enclosures		Packs of	Model No.
Height mm	Depth mm		
800	600	2 pc(s).	8173.245
1200	500	2 pc(s).	8115.245
1200	600	2 pc(s).	8170.245
1200	800	2 pc(s).	8175.245
1200	1000	2 pc(s).	8176.245
1400	500	2 pc(s).	8145.245
1600	500	2 pc(s).	8165.245
1600	600	2 pc(s).	8166.245
1600	800	2 pc(s).	8168.245
1800	400	2 pc(s).	8184.245
1800	500	2 pc(s).	8185.245
1800	600	2 pc(s).	8186.245
1800	800	2 pc(s).	8188.245
2000	400	2 pc(s).	8104.245
2000	500	2 pc(s).	8105.245
2000	600	2 pc(s).	8106.245
2000	800	2 pc(s).	8108.245
2000	1000	2 pc(s).	8100.245
2000	1200	2 pc(s).	8102.245
2200	600	2 pc(s).	8126.245
2200	800	2 pc(s).	8128.245
2200	1000	2 pc(s).	8120.245
2200	1200	2 pc(s).	8122.245



Accessories:

- Hinge for side panel, screw-fastened, sheet steel, see page 902



Side panel, screw-fastened, stainless steel

for VX

- Time-saving assembly thanks to clip-in side panel holders
- Automatic potential equalisation and higher EMC protection, thanks to enclosure panel holders with earthing inserts located on the inside
- Easy positioning in the height and depth with the location aid
- Simple assembly
- Earthing bolts with large, paint-free contact surface for optimum contact

Material:

- Stainless steel 1.4301 (AISI 304), 1.5 mm

Surface finish:

- Brushed, grain size 400

Protection category IP to IEC 60 529:

- IP 55 (in conjunction with enclosures from the VX series)

Protection category NEMA:

- NEMA 12 (in conjunction with enclosures from the VX series)

Supply includes:

- Assembly parts

For enclosures		Packs of	Model No.
Height mm	Depth mm		
1800	400	2 pc(s).	8700.030
1800	500	2 pc(s).	8700.040
2000	600	2 pc(s).	8700.050



Walls

Side panels

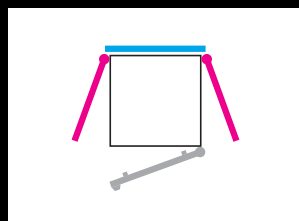

Hinge

for side panel, screw-fastened, sheet steel

The 180° opening angle allows unhindered access from the side.

Material:

- Die-cast zinc

Colour:

- RAL 7035

Protection category IP to IEC 60 529:

- IP 55 (in conjunction with enclosures from the VX, VX IT series)

Supply includes:

- Assembly parts

Packs of	Model No.
6 pc(s).	8106.260

Note:

- Hinge mounting (red) is only possible in the vicinity of the rear panel (blue)
- Only for use with a side panel depth of 800 mm or less

Internal latch

for side panel, screw-fastened, sheet steel

Additional security is achieved via the option of latching the side panel from the inside. The side panels on the frame section are screw-fastened from the inside with latching brackets.

Surface finish:

- Sheet steel, zinc-plated

Protection category IP to IEC 60 529:

- IP 55 (in conjunction with enclosures from the VX, VX IT series)

Supply includes:

- 2 mounting brackets
- Assembly parts

Packs of	Model No.
2 pc(s).	5301.235

Assembly instruction:

- Access via the front and rear doors must be guaranteed

Side panel, horizontally divided for VX IT

For sealing IT enclosure systems, both stand-alone and baying arrangements.

Benefits:

- Simple handling
- Supports tool-free installation and removal of the side wall
- Locked using security lock 3524 E
- Integral internal latch

Material:

- Sheet steel

Surface finish:

- Powder-coated

Colour:

- RAL 7035

Protection category IP to IEC 60 529:

- IP 20

Supply includes:

- Top piece
- Bottom piece
- 6 mounting brackets
- 2 lock components
- Assembly parts

For enclosure height mm	For enclosure depth mm	Packs of	Model No.
2000	1000	1 pc(s).	5301.250
2000	1200	1 pc(s).	5301.254
2200	1000	1 pc(s).	5301.257
2200	1200	1 pc(s).	5301.261
2450	1000	1 pc(s).	5301.264
2450	1200	1 pc(s).	5301.265

Side panel, vertically divided for VX IT

Benefits:

- Simple handling
- Easy to close with snap fasteners
- Optimum access to all installed components
- Opening is only possible via internal locking elements, which requires free access via the doors, but significantly increases access security
- Individual side parts may be completely dismantled at any time without the need for tools

Material:

- Sheet steel

Surface finish:

- Powder-coated

Colour:

- RAL 7035

Protection category IP to IEC 60 529:

- IP 20

For enclosure height mm	For enclosure depth mm	Packs of	Model No.
2000	800	1 pc(s).	5301.246
2000	1000	1 pc(s).	5301.236
2000	1200	1 pc(s).	5301.242
2200	800	1 pc(s).	5301.243
2200	1000	1 pc(s).	5301.244
2200	1200	1 pc(s).	5301.245

Supply includes:

- 2 side parts
- Punched rail
- 6 hinges
- 4 quick-release fasteners
- Assembly parts



Assembly instruction:

- Access via the front and rear doors must be guaranteed



Side panel for TE 8000

Simple assembly with insertion aid at the bottom and lock at the top. Earthing bolt with contact lug.

Material:

- Sheet steel

Surface finish:

- Powder-coated

Colour:

- RAL 7035

For enclosure height mm	For enclosure depth mm	Packs of	Model No.
2000	800	2 pc(s).	7888.652
2000	1000	2 pc(s).	7888.653

Protection category IP to IEC 60 529:

- IP 20

Supply includes:

- 4 cam locks including security lock 3524 E



Corrosion protection primer

The one-component primer is suitable as corrosion protection on paint-free spots which occur due to cut-outs etc. Used to renew corrosion protection of paint-free spots in accordance with the standard IEC 61439 for low-voltage and switchgear assemblies.

Benefits:

- Exceptional bonding
- Passive protection from corrosion
- Very high filling force

Colour:

- Dark grey

	Contents ml	Packs of	Model No.
Paint pen	12	1 pc(s).	2436.800



Paint

For touching up and repairing powder-coated and wet-painted surfaces, air-drying.

	Colour	Model No.
Touch-up pen 12 ml	RAL 7035	2436.735
Tin 1000 ml	RAL 7035	2438.735
Spray can 150 ml	RAL 7035	2440.735
	RAL 9005	2440.905



Walls

Divider panels/partitions

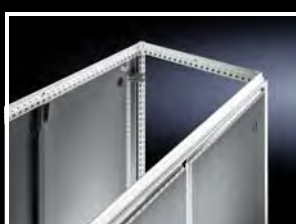
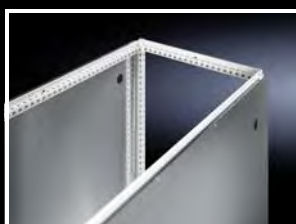

Partition, one-piece, for slide-in fixing

for VX IT

For rack mounting, suspended between two bayed enclosures. With one Ø 40 mm hole in the left-hand and right-hand corner areas for inserting cables, conduits etc. These drilled holes may be sealed with the enclosed cover caps.

Benefits:

- Simply slides into position

Material:

- Sheet steel, zinc-plated

Protection category:

- IP 20 (with fitted cover caps)

Supply includes:

- Partition
- 2 cover caps

Note:

- Use baying connector, external, 3 mm
- Not suitable for use in conjunction with a baying seal
- Any baying seal that may be present must be removed prior to installation

For enclosure height mm	For enclosure depth mm	Packs of	Model No.
2000	1000	1 pc(s).	5301.270
2000	1200	1 pc(s).	5301.281
2200	1000	1 pc(s).	5301.287
2200	1200	1 pc(s).	5301.300
2450	1000	1 pc(s).	5301.315
2450	1200	1 pc(s).	5301.317

Assembly instruction:

- A baying gap of 3 mm is required to insert the partition

Accessories:

- Baying connector, external, 3 mm, see page 914

Partition, vertically divided, for screw fastening

for VX IT

For retrospective installation/dismantling of bayed enclosures. The integrated sealing profile supports enclosure sealing for climate control or for applications with extinguisher gas. It may be fitted from the outside prior to baying the enclosure, or from the inside after baying the enclosure. As the partition is located inside the frame structure, it may be retrofitted at any time. There are no specific required baying distances between the enclosures.

Material:

- Sheet steel, zinc-plated

Supply includes:

- 2 partitioning plates
- 4 cover caps
- Punched rail
- Seal
- Assembly parts

For enclosure height mm	For enclosure depth mm	Packs of	Model No.
2000	1000	1 pc(s).	5301.274
2000	1200	1 pc(s).	5301.284
2200	1000	1 pc(s).	5301.291
2200	1200	1 pc(s).	5301.303
2450	1000	1 pc(s).	5301.319
2450	1200	1 pc(s).	5301.321

Assembly instruction:

- Assembly/removal only supported for enclosures without interior installation

Accessories:

- Baying connector, external, see page 912
- Baying connector, external, 3 mm, see page 914

Divider panels/partitions

Divider panel

for VX

For shielding individual enclosure cells. Thanks to the symmetry of the frame system, the divider panel can also be used at the rear. All-round, double fold for stability and to hold the seal.

Material:

- Sheet steel, 1.5 mm

Surface finish:

- Zinc-plated

Protection category IP to IEC 60 529:

- IP 54 (in conjunction with enclosures from the VX series)

Supply includes:

- Assembly parts



Also required:

- When buying in conjunction with a divider panel:
Baying bracket, internal 8617.500, see page 912 or
baying connector, external 8617.502/ 8617.503, see page 912



Accessories:

- Cover with door, see page 908

For enclosures		Model No.
Height mm	Depth mm	
1800	400	8609.200
1800	500	8609.201
1800	600	8609.202
2000	400	8609.203
2000	500	8609.204
2000	600	8609.205
2000	800	8609.206
2200	600	8609.207

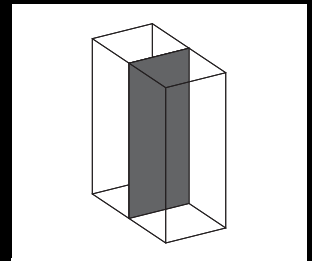
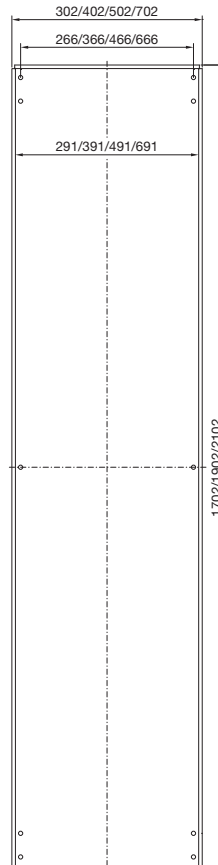

Walls

Divider panels/partitions

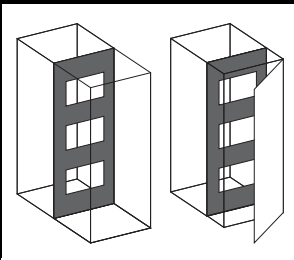
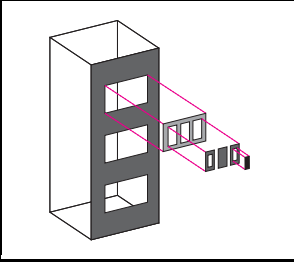

Divider panel

for module plates for VX

With cut-outs for the installation of module plates for connectors or for cable entry, and also for the entry of busbar systems and other installed equipment. All-round, double fold for stability and to hold the seal. The symmetry of the enclosure frame means that divider panels may also be fitted at the rear, dimensions permitting.

Material:

- Sheet steel, 2 mm

Surface finish:

- Zinc-plated

Supply includes:

- Seal and assembly parts



Also required:

- When buying in conjunction with a divider panel:
Baying bracket, internal 8617.500, see page 912
or
baying connector, external 8617.502/ 8617.503,
see page 912



Accessories:

- Module plates, see page 907
- Cover with door, see page 908
- Baying bracket, internal, see page 912

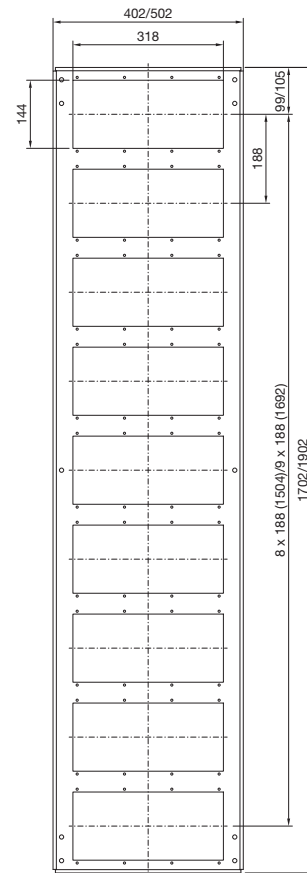

For enclosures		Number of cut-outs	Model No.
Height mm	Depth mm		
1800	500	9	8609.210
1800	600	9	8609.211
2000	500	10	8609.212
2000	600	10	8609.213

Divider panels/partitions

Module plates

Material:

- Sheet steel, 2 mm

Surface finish:

- Zinc-plated

Supply includes:

- Seal

Version	Cut-outs	Packs of	Model No.
Solid	-	1 pc(s).	8609.160
For 16-pole connectors	4	1 pc(s).	8609.150
For 24-pole connectors	4	1 pc(s).	8609.140
For cable entry	1	1 pc(s).	8609.170
With cable sleeve	1	1 pc(s).	8609.390

Solid

For sealing unused cut-outs. Easily machined for individual cut-outs.

For 16/24-pole connectors

With cut-outs to accommodate connectors.



Accessories:

- Adaptor, cover plate, see page 908
- Connector gland for connector cut-outs, see page 1046
- Sealing frame, modular, see page 1048

For cable entry

For the entry of pre-assembled cables. Sealed, secure routing is achieved via adjustable angle brackets with inserted foam cable clamp strip. Fixed bracket, punched, for cable clamping.



Accessories:

- Cable tie for fast assembly 2597.000, see page 1061

With cable sleeve

For cable diameters from 10 to 65 mm. The flexible grommet adapts to the cable's bending radius

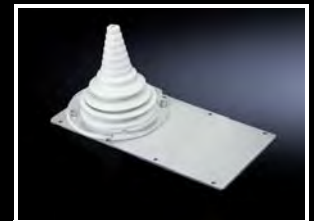

Walls

Divider panels/partitions



Adaptor

for connector cut-outs

For using connectors with varying numbers of poles.

Material:

- Sheet steel

Surface finish:

- Zinc-plated

Supply includes:

- Seal and assembly parts

For reduction	Packs of	Model No.
From 24 to 16 poles	5 pc(s).	2479.000
From 24 to 10 poles	5 pc(s).	2480.000
From 24 to 6 poles	5 pc(s).	2481.000
From 16 to 10 poles	5 pc(s).	2401.000
From 16 to 6 poles	5 pc(s).	2402.000



Cover plate

for connector cut-outs

For unused cut-outs.

Material:

- Sheet steel

Surface finish:

- Zinc-plated

Supply includes:

- Seal and assembly parts

For	Packs of	Model No.
24-pole cut-outs	20 pc(s).	2477.000
16-pole cut-outs	20 pc(s).	2478.000



Cover with door

for VX

- To protect and finish off connectors or other installed equipment.
- Optional cable entry from above or below

Material:

- Cover: Sheet steel, 1.5 mm
- Door: Sheet steel, 2.0 mm

Surface finish:

- Dipcoat-primed, powder-coated on the outside

Colour:

- RAL 7035

Protection category IP to IEC 60 529:

- IP 55 (in conjunction with enclosures from the VX series)

Protection category to NEMA:

- NEMA 12 (in conjunction with enclosures from the VX series)

Supply includes:

- Cover
- Door with locking rod and double-bit lock insert
- 2 trim panels for top and bottom

For enclosures		Model No.
Height mm	Depth mm	
2000	500	8609.220
2000	600	8609.230



Accessories:

- Lock inserts, type G, see page 941
- Comfort handle VX, see page 937
- 180° hinge, see page 951

Isolator door locking

Isolator door cover

for VX

Including main door latch for safety locking of enclosures and bayed enclosure suites in accordance with UL regulations. Tested in conjunction with actuator lever for master switch from the following companies:

- Allen Bradley
- Square D
- General Electric
- Eaton
- Siemens

A detailed overview of types can be found on the Internet, together with the product description.

Benefits:

- Meets the requirements of UL 508 A
- In conjunction with the operating mechanism, adjacent door lock and interconnecting rods, these requirements are also met for bayed combinations
- Optional mounting on the left or right of the enclosure. With this cover, all single-door bayed enclosures may be configured as isolator door enclosures. The complete installation surface of the enclosure is retained.
- In conjunction with the integrated mounting plate infill, the mounting surface of the main enclosure can be enlarged by up to 14%.
- Two cut-outs for actuator levers on the front, for internal mounting at varying heights

Protection category IP to IEC 60 529:

- IP 55 (in conjunction with enclosures from the VX series)

Protection category to NEMA:

- NEMA 12 (in conjunction with enclosures from the VX series)

Supply includes:

- Main door lock, cover plate and assembly parts

Note:

- Cover may only be mounted on a single-door enclosure with tubular door frame



Also required:

For bayed suites:

- Operating mechanism 4912.000, for enclosure with isolator door cover and additionally in every fourth adjacent enclosure, see page 910
- Adjacent door latch 4911.000, 4911.100, for every adjacent enclosure, see page 910
- Interconnecting rods, for every adjacent enclosure in the appropriate enclosure width, see page 910
- Side panel, screw-fastened, see page 901



Accessories:

- Mounting plate infill, see page 971

Isolator door lock

- 1 Operating mechanism
- 2 Adjacent door latch (single-door)
- 3 Interconnecting rod
- 4 Connection component
- 5 Main door latch
- 6 Adjacent door latch (two-door)
- 7 Side panel, screw-fastened

Installation to the right of the enclosure

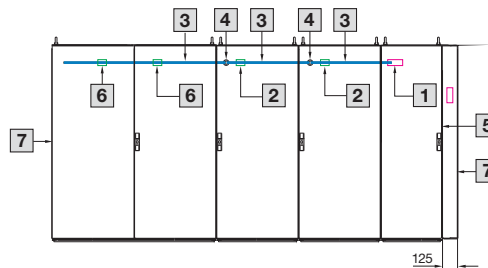

Width mm	Height mm	Depth mm	Material thickness mm	Surface finish	Colour	Model No.	
						Sheet steel	Stainless steel 1.4301 (AISI 304)
103	1800	400	1.5	Powder-coated	RAL 7035	8951.020	-
103	1800	400	1.5	Brushed, grain size 400	-	-	8952.020
103	1800	500	1.5	Powder-coated	RAL 7035	8951.030	-
103	1800	500	1.5	Brushed, grain size 400	-	-	8952.030
103	2000	500	1.5	Powder-coated	RAL 7035	8951.000	-
103	2000	500	1.5	Brushed, grain size 400	-	-	8952.000
103	2000	600	1.5	Powder-coated	RAL 7035	8951.010	-
103	2000	600	1.5	Brushed, grain size 400	-	-	8952.010

Walls

Isolator door locking

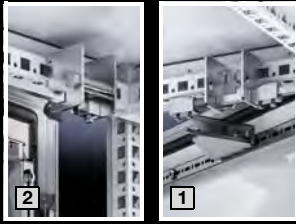

Door latch for bayed enclosure suites

In conjunction with the isolator door cover, the requirements of UL 508 A are also met for bayed enclosure suites. Depending on the baying combination, different components will be required; refer to the assembly sketch on page 909.

Note:

- The door latch for bayed enclosure suites can also be used without the isolator door cover and in combination with commercially available master switches. In this way, adjacent doors cannot be opened until the main door has been opened.

1 Operating mechanism

Fitted in the enclosure with main switch and additionally in every fourth adjacent enclosure

	Packs of	Model No.
Operating mechanism	1 pc(s).	4912.000

2 Adjacent door latch

Installation in adjacent enclosure

Adjacent door latch for	Packs of	Model No.
Single-door enclosures	1 pc(s).	4911.000
Two-door enclosures	1 pc(s).	4911.100

3 Interconnecting rods

To extend locking from the main enclosure to the adjacent enclosures of a bayed suite. One interconnecting rod corresponding to the width of the enclosure is required for each adjacent enclosure.

For enclosure width mm	Packs of	Model No.
600	10 pc(s).	4916.000
800	10 pc(s).	4918.000
1200	10 pc(s).	4920.000

Baying system

Baying

Bayable on all sides

Whether around corners, forwards, backwards, to the left or right or even upwards if required, the baying options are unlimited.

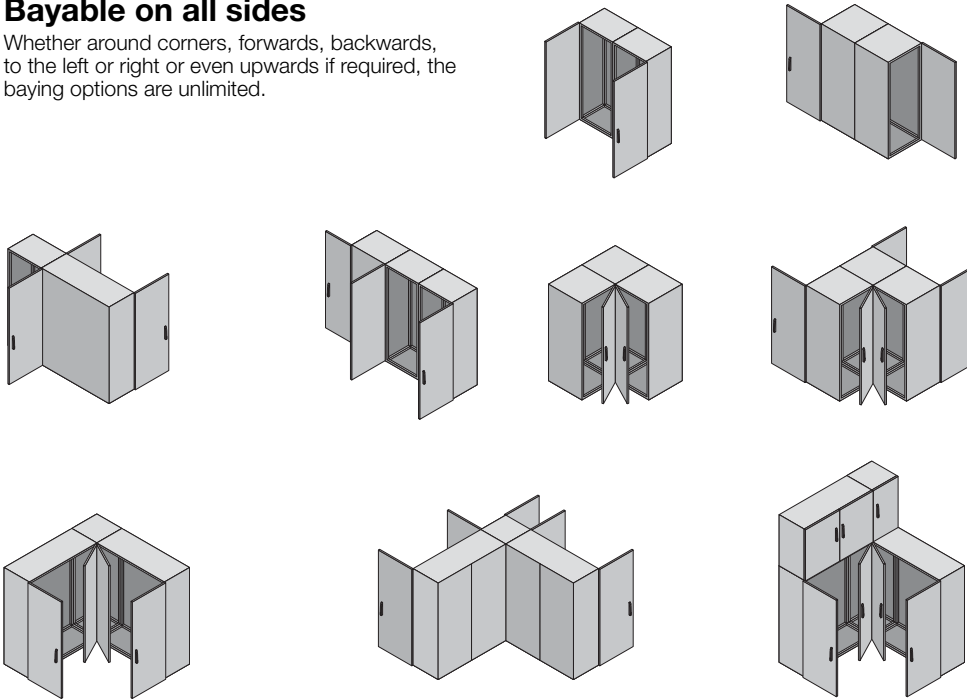

Overview of bayed VX/VX IT

- | | |
|--|---|
| 1 Baying bracket, internal, for VX/VX IT | 5 Angular baying bracket for VX |
| 2 Baying block, internal, for VX | 6 Combination angle for VX |
| 3 Baying connectors, external, for VX/VX IT | 7 Baying connector, external, 3 mm for VX IT |
| 4 Quick-fit baying clamp for VX | 8 Baying connector for VX IT/TS IT |

Notes on the transportation of bayed VX enclosures, see page 915.

VX

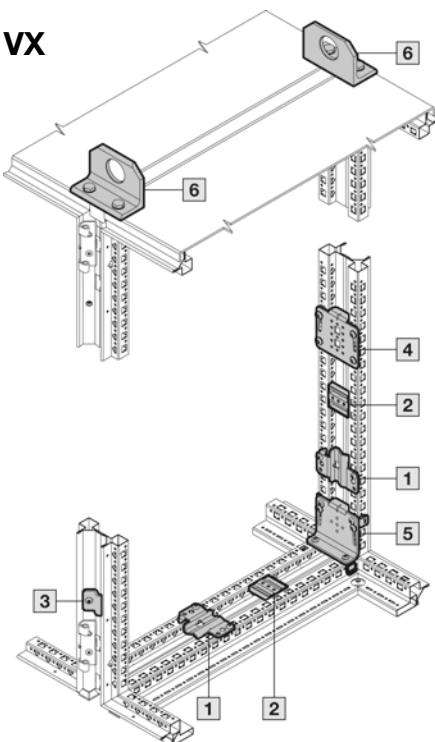

VX IT

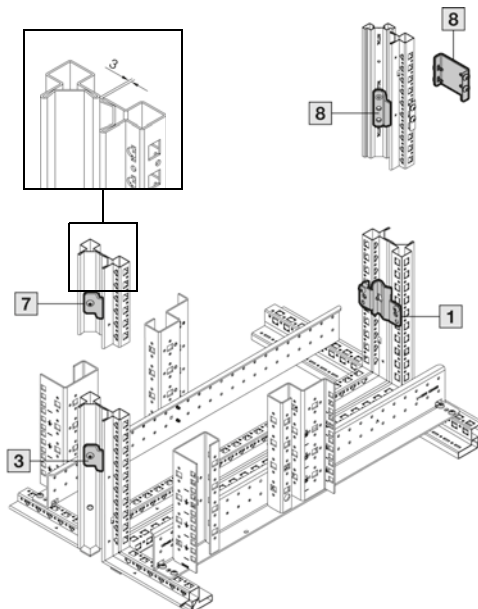

Baying system

Baying



Baying bracket, internal

for VX, VX IT

- Fast, secure installation either from the front or from the side
- For all-round installation on the baying point
- May be flexibly positioned to avoid collisions with installed equipment
- Also suitable for baying base/plinth components

Material:

- Sheet steel

Surface finish:

- Zinc-plated

Supply includes:

- Baying bracket, internal
- Baying seal
- Assembly parts

Packs of	Model No.
6 pc(s).	8617.500

Note:

- 1 pack is sufficient for one baying joint
- Transportation of bayed enclosures, see page 915

Possible alternative:

- Baying block, internal, see page 912
- Baying connector, external 8617.502, see page 912



Baying block, internal

for VX, VX IT

- Side mounting creates a flush surface to the profile, suitable for top mounting, thus avoiding collisions with installed equipment
- For all-round installation on the baying point

Material:

- Die-cast zinc

Supply includes:

- Baying block, internal
- Baying seal
- Assembly parts

Packs of	Model No.
6 pc(s).	8617.501

Note:

- 1 pack is sufficient for one baying joint

Possible alternative:

- Baying bracket, internal, see page 912
- Baying connector, external 8617.502, see page 912

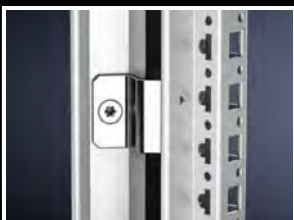
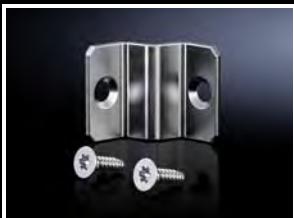

Baying connector, external

for VX, VX IT

For mounting on the vertical enclosure sections from the outside.

Supply includes:

- Baying connector, external
- Baying seal
- Assembly parts

Material	Packs of	Model No.
Sheet steel, zinc-plated	6 pc(s).	8617.502
Stainless steel 1.4301 (AISI 304)	6 pc(s).	8617.503

Note:

- 1 pack is sufficient for one baying joint

Possible alternative:

- Baying bracket, internal, see page 912
- Baying block, internal, see page 912

Baying system

Baying

Quick-fit baying clamps

for VX

- For all-round installation on the baying point
- May be flexibly positioned to avoid collisions with installed equipment
- Simply tighten the screws, tap in the quick-fit baying clamp, pull the enclosures together and secure
- Additional mounting level between bayed enclosures, e.g. for mounting cable ducts

Material:

- Sheet steel

Surface finish:

- Zinc-plated

Supply includes:

- Assembly parts

Packs of	Model No.
6 pc(s).	8617.506

Note:

- 1 pack is sufficient for one baying joint



Accessories:

- Baying seal 8617.507, see page 914

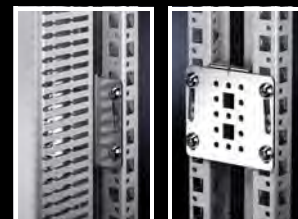

Angular baying bracket

for VX

For stable connection in the corners of bayed enclosures. Perfectly suited for aligning enclosures with one another on uneven floors

Material:

- Sheet steel

Surface finish:

- Zinc-plated

Supply includes:

- Assembly parts

Packs of	Model No.
4 pc(s).	8617.508

Note:

- 1 pack is sufficient for one baying joint
- To achieve the required protection category and transportation stability, further baying connectors should be used halfway up the enclosure



Baying connector, external, 9 mm

for VX IT/VX IT with side panels

For retrospective baying of enclosures with side panels.

Material:

- Sheet steel

Colour:

- RAL 7035

Supply includes:

- Assembly parts

Packs of	Model No.
4 pc(s).	7824.540



Baying system

Baying



Baying connector, external, 3 mm

for VX IT

Applications:

- For retrospectively exchanging racks or LCP devices
- For retroactive installation/removal of partitions, one-piece, slide-in

Benefits:

- Supports retroactive exchange of racks or LCP devices
- Guarantees the required baying distance of 3 mm for carrying out retrospective modifications

Material:

- Sheet steel

Surface finish:

- Zinc-plated

Supply includes:

- 4 baying connectors, external, 3 mm
- Baying seal, 8 m
- Assembly parts

Packs of	Model No.
1 pc(s).	5301.310

Note:

- Within a bayed enclosure suite, the external dimension is increased by 2 mm per baying point
- The maximum achievable IP protection category to IEC 60 529 is IP 20.

Baying clamp

for VX IT/TS IT

For baying enclosures in the VX IT series to TS IT.

Material:

- Sheet steel

Surface finish:

- Zinc-plated

Supply includes:

- 4 baying connectors, external
- 2 baying connectors, internal
- Baying seal, 8 m
- Assembly parts

Packs of	Model No.
1 pc(s).	5301.312

Note:

- The maximum achievable IP protection category to IEC 60 529 is IP 54

Baying seal

for VX

May be used individually for baying on all existing enclosure sizes. The seal sits securely around the section edge, and is easily removed at any time without leaving any residues. It is also reusable.

Packs of	Model No.
1 pc(s).	8617.507

Material:

- EPDM

Supply includes:

- 8 m

Notes on the transportation of bayed VX enclosures

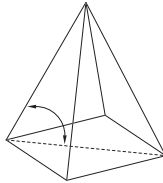
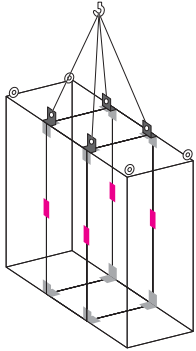

When transporting bayed enclosures, for example, the baying bracket, internal (8617.500), the baying block, internal (8617.501) or the baying connector, external (8617.502 and 8617.503) may be used in conjunction with the combination angle (4540.000). The load capacity with a cable pull angle of 60° is as follows:
 for the left-hand enclosure 7000 N,
 for the central enclosure 14000 N,
 for the right-hand enclosure 7000 N.

The cable pull angle between the roof plate and the cable has a significant influence on the total permissible load. The cable pull angle must not be less than 45°, and ideally not less than 60°.

Combination angle

for VX

For optimum distribution of tensile forces during transportation of bayed enclosures by crane.

Material:

- Sheet steel

Surface finish:

- Zinc-plated

Supply includes:

- Assembly parts

Packs of	Model No.
4 pc(s).	4540.000



Accessories:

- Baying cover, top, see page 915



Baying cover, top

for VX, VX IT

A cover with two end caps may additionally be clipped over the seal between the two enclosures. This prevents dirt and liquid from accumulating on the baying seal.

Supply includes:

- Assembly parts

Note:

- May also be fitted in the width with enclosure suites bayed back-to-back
- May be cut to required length, if necessary.
- May also be used in conjunction with dust guard trim, see page 959

For enclosure depth mm	Packs of	Plastic RAL 7035	Stainless steel 1.4301 (AISI 304)	Model No.
400	1 pc(s).	■	-	8800.845
500	1 pc(s).	■	-	8800.855
600	1 pc(s).	■	-	8800.865
800	1 pc(s).	■	-	8800.885
400	1 pc(s).	-	■	8700.140
500	1 pc(s).	-	■	8700.150
600	1 pc(s).	-	■	8700.160
1000 - 1200	1 pc(s).	■	-	8800.825



Baying system

Baying



Baying cover, vertical

for VX

To balance out the gap between the side panels when baying back-to-back. For enclosure height 2200 mm, or may be cut to length individually for lower heights.

Material:

- Cover section: Plastic

Colour:

- RAL 7035

Supply includes:

- Assembly parts

Packs of	Model No.
2 pc(s).	8800.875



Also required:

- Baying connector, external, 8617.502, see page 912

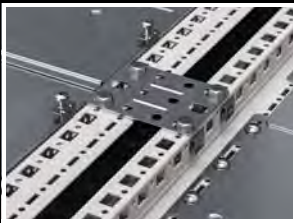

Baying kit, VX25 to TS 8

For extending existing TS 8 bayed enclosure suites with VX25 enclosures.

Material:

- Baying connector: Sheet steel

Supply includes:

- 8 baying connectors
- 1 seal
- Assembly parts

Packs of	Model No.
1 pc(s).	8617.505



Baying kit

for TE/TE

For connecting individual enclosures into bayed suites at the sides. The enclosures are connected between the base and roof frame.

Benefits:

- Baying of TE 8000 to TE 7000 enclosures is supported

Width mm	Packs of	Model No.
55	4 pc(s).	7888.640

Material:

- Sheet steel, spray-finished

Colour:

- RAL 7035

Supply includes:

- Assembly parts



Baying kit

for AX, KX

For baying AX/KX enclosures.

The additional cut-outs are to be provided by the customer.

Special screws and nuts

- For fast, simple assembly without thread-tapping
- Compression of the seal is limited to a predefined level, to ensure a long-lasting, permanent seal between enclosures

Seal, self-adhesive

- Comprised of bayable sealing elements and corner pieces, for individual adaptation to various enclosure sizes

One pack is sufficient for a baying joint up to H x D = 800 x 350 mm.

Packs of	Model No.
1 pc(s).	1199.100

Supply includes:

- Special screws and nuts
- Sealing elements, self-adhesive



Door variants

Glazed door

for VX

Instead of a sheet steel door or rear panel.

Material:

- Frame: Extruded aluminium section
- Viewing window: Single-pane safety glass, 3 mm

Surface finish:

- Powder-coated

Colour:

- Frame and corner pieces: RAL 7035
- Viewing window (printed mask on the inside): RAL 9005

Protection category IP to IEC 60 529:

- IP 55

Supply includes:

- Glazed door
- Locking rod with double-bit lock insert and lock plate
- 180° hinges, 4 pc(s).

For enclosures		Model No.
Width mm	Height mm	
600	1800	8618.000
800	1800	8618.010
600	2000	8618.020
800	2000	8618.030
600	2200	8618.040
800	2200	8618.050



Also required:

- When mounting instead of the rear panel or double door: Lock components for frame 8618.110, see page 917



Accessories:

- Comfort handle VX, see page 937
- Lock inserts, type G, see page 941



Lock components

For retrofitting a glazed door or sheet steel door in place of a rear panel.

Material:

- Die-cast zinc

Supply includes:

- Assembly parts

Packs of	Model No.
4 pc(s).	8618.110



Lockable and adjacent door

for VX

For example, if two 400 mm doors are used instead of one 800 mm wide door in order to comply with escape routes. May also be fitted instead of an 800 mm wide rear panel.

Material:

- Sheet steel

Surface finish:

- Dipcoat-primed, powder-coated on the outside

Colour:

- RAL 7035

Protection category IP to IEC 60 529:

- IP 55

Supply includes:

- 2 doors, including tubular door frame, hinges and lock components

For enclosures		Model No.
Width mm	Height mm	
800	2000	8618.120



Accessories:

- Comfort handle VX, see page 937
- Lock inserts, type G, see page 941



Doors/locks

Door variants



Glazed door

for VX SE

Instead of a sheet steel door.

Material:

- Frame: Extruded aluminium section
- Corner pieces: Die-cast zinc
- Viewing window: Single-pane safety glass, 3 mm

Surface finish:

- Powder-coated

Colour:

- Frame and corner pieces: RAL 7035
- Viewing window (printed mask on the inside): RAL 9005

Protection category IP to IEC 60 529:

- IP 55

Supply includes:

- Glazed door
- Locking rod with double-bit lock insert and lock plate
- 180° hinges, 4 pc(s).

For enclosures		Model No.
Width mm	Height mm	
600	1800	8610.685
800	1800	8610.885
600	2000	8610.605
800	2000	8610.805



Accessories:

- Comfort handle, see page 938
- Lock inserts, version F, see page 941

Handle adaptor

The handle adaptor compensates for the design chamfer in the door profile to enable installation of the comfort handle.

Material:

- Plastic

Supply includes:

- 1 adaptor plate
- 1 bolt to extend the screw-on dome
- 2 assembly screws

For glazed door VX SE

Colour	Model No.
RAL 7035	8611.080

For designer door IW and PC, bottom door

Colour	Model No.
RAL 7035	8611.300

Glazed door VX IT

for Automatic Door Opening (ADO)

With integral vent valves for automated opening function in the event of an alarm or power failure. The glazed door for the Automatic Door Opening System replaces the standard VX IT door.

Benefits:

- Supports remote control via the CMC III system
- Tinted single-pane safety glass ensures a high standard of safety
- Combining the vent flaps with a tubular door frame creates exceptional stability
- The vent flaps only protrude into the escape route by 200 mm
- No adjustment to the lock systems system required
- Manual opening of the door without any effect on the vent flaps
- Automatic opening of the vent valves in the event of a power failure

Functional principle:

- Activation via CMC III door control module (DCM)
- Automatic, mechanical opening of the integral vertical ventilation flaps in an emergency if the cooling system fails or an extinguishing system is activated
- Depending on the room volume and temperature, the air inside the room is used for emergency cooling, or the extinguisher gas may flow directly into the IT enclosures

Technical specifications:

- Rated voltage: 24 V DC
- Rated current: 780 mA
- External projection of the vent flap: 200 mm (when opened)
- Internal projection of the mechanism: 52.5 mm
- Connection cable from door catch: 2.5 m
- Door hinged on the right, may be swapped to the left
- Spring damper for flap opening
- Magnets for fixing the flaps
- Valves are open at zero current

Protection category IP to IEC 60 529:

- IP 20 for solid vent flaps

Supply includes:

- Glazed door with comfort handle VX for profile half-cylinders
- Connection cable

Note:

- Other colours (RAL 9005) and sizes (H = 2200 mm) available on request



Also required:

- Door control module, see page 817
- CMC III power pack, see page 818



Accessories:

- CMC III Processing Unit/Compact with connection, power supply and mounting accessories, from page 804
- Lock inserts, see page 942



Design	Material	Colour	Dimensions		Packs of	Model No.
			Width mm	Height mm		
One-part, with vent flaps	Frame: Extruded aluminium section Viewing window: Single-pane safety glass, tinted	-	600	2000	1 pc(s).	7030.262
			800	2000	1 pc(s).	7030.263
One-part, with vent flaps	Frame: Sheet steel Viewing window: Single-pane safety glass, tinted	RAL 7035	600	2000	1 pc(s).	7030.272
			800	2000	1 pc(s).	7030.273
Two-part, vertically divided, with vent flaps	Frame: Sheet steel Viewing window: Single-pane safety glass, tinted	RAL 7035	600	2000	1 pc(s).	7030.282
			800	2000	1 pc(s).	7030.283

Doors/locks

Door variants



Glazed aluminium door, one-piece

for VX IT

To replace existing doors.

Material/surface finish:

- Frame: Extruded aluminium section
- Vertical extrusion: Aluminium, anodised
- Horizontal extrusion: Aluminium, spray finished
- Viewing window: Single-pane safety glass, 3 mm

Colour:

- Comfort handle VX, hinges, horizontal extrusion: RAL 9005
- Vertical profile: silver coloured

Protection category IP to IEC 60 529:

- IP 55

Supply includes:

- Door with comfort handle VX for profile half-cylinders with security lock 3524 E
- 3 x 180° hinges, fitted
- Assembly parts

Note:

- Door opening angle for stand-alone siting: max. 240°
- Door opening angle when baying: max. 105°

For enclosures		Packs of	Model No.
Width mm	Height mm		
800	2000	1 pc(s).	5301.423

Assembly instruction:

- For a door opening angle of 180° when baying, a 180° baying hinge is required, see page 951



Glazed sheet steel door, vertically divided

for VX IT

To replace existing doors. With underlaid viewing panel and 4-point locking rod. The divided design allows room-optimised siting of the enclosures coupled with the best possible access, thanks to a reduced distance between the individual bayed enclosure suites.

Material:

- Frame: Sheet steel
- Viewing window: Single-pane safety glass, 3 mm

Surface finish:

- Powder-coated

Colour:

- Frame: RAL 7035
- Comfort handle VX, hinges: RAL 9005

Protection category IP to IEC 60 529:

- IP 55

Supply includes:

- Door, vertically divided, with comfort handle VX for profile half-cylinders with security lock 3524 E, right
- 4 x 180° hinges, fitted on each half of the door
- Assembly parts

Note:

- Door opening angle for stand-alone siting: max. 240°
- Door opening angle when baying: max. 160°

For enclosures		Packs of	Model No.
Width mm	Height mm		
800	2000	1 pc(s).	5301.437
800	2200	1 pc(s).	5301.438

Assembly instruction:

- For a door opening angle of 180° when baying, a 180° baying hinge is required, see page 951



Door variants

Sheet steel door, one-piece, solid

for VX IT

To replace existing doors.

Material:

- Sheet steel

Surface finish:

- Spray-finished

Colour:

- Door: RAL 7035
- Comfort handle VX: RAL 9005

Protection category IP to IEC 60 529:

- IP 55

Supply includes:

- Door with comfort handle VX for profile half-cylinders with security lock 3524 E
- 4 x 130° hinges, inside
- Assembly parts

Note:

- Door opening angle for stand-alone siting: max. 165°
- Door opening angle when baying: max. 110°

For enclosures		Packs of	Model No.
Width mm	Height mm		
800	2000	1 pc(s).	5301.540
800	2200	1 pc(s).	5301.542



Assembly instruction:

- For a door opening angle of 180° when baying, a 180° baying hinge is required, see page 951



Sheet steel door, vertically divided, solid

for VX IT

To replace existing doors. Thanks to the minimal rotation radius of the individual doors, the distance between individual bayed enclosure suites may be reduced.

Material:

- Sheet steel

Surface finish:

- Spray-finished

Colour:

- Door: RAL 7035
- Comfort handle VX, hinges: RAL 9005

Protection category IP to IEC 60 529:

- IP 20

Supply includes:

- Door, vertically divided, with comfort handle VX for profile half-cylinders with security lock 3524 E, right
- 3 x 180° hinges, fitted on each half of the door
- Assembly parts

Note:

- Door opening angle for stand-alone siting: max. 240°
- Door opening angle when baying: max. 160°

For enclosures		Packs of	Model No.
Width mm	Height mm		
600	2000	1 pc(s).	5301.602
800	2000	1 pc(s).	5301.612



Assembly instruction:

- For a door opening angle of 180° when baying, a 180° baying hinge is required, see page 951



Doors/locks

Door variants



Aluminium/sheet steel door, vented

for VX IT

To replace existing doors. The vented surface area is approx. 85% perforated.

Material/surface finish:

- Frame: Extruded aluminium section
- Vent grille: Sheet steel
- Vertical extrusion: Aluminium, anodised
- Horizontal extrusion: Aluminium, spray finished

Colour:

- Comfort handle VX, hinges, horizontal extrusion, vent grille: RAL 9005
- Vertical profile: silver coloured

Supply includes:

- Door with comfort handle VX for profile half-cylinders with security lock 3524 E
- 3 x 180° hinges, fitted
- Assembly parts

Note:

- Door opening angle for stand-alone siting: max. 240°
- Door opening angle when baying: max. 105°

For enclosures		Packs of	Model No.
Width mm	Height mm		
600	2200	1 pc(s).	5301.450
800	2000	1 pc(s).	5301.446
800	2200	1 pc(s).	5301.453



Assembly instruction:

- For a door opening angle of 180° when baying, a 180° baying hinge is required, see page 951



Sheet steel door, one-piece, vented

for VX IT

To replace existing doors. The vented surface area is approx. 85% perforated.

Material:

- Sheet steel

Surface finish:

- Spray-finished

Colour:

- Door: RAL 7035
- Comfort handle VX: RAL 9005

Protection category IP to IEC 60 529:

- IP 20

Supply includes:

- Door with comfort handle VX for profile half-cylinders with security lock 3524 E
- 3 x 130° hinges, fitted on the inside
- Assembly parts

Note:

- Door opening angle for stand-alone siting: max. 165°
- Door opening angle when baying: max. 110°

For enclosures		Packs of	Model No.
Width mm	Height mm		
600	2000	1 pc(s).	5301.561
800	2000	1 pc(s).	5301.571



Assembly instruction:

- For a door opening angle of 180° when baying, a 180° baying hinge is required, see page 951



Door variants

Sheet steel door, vertically divided, vented

for VX IT

To replace existing doors. The vented surface area is approx. 85% perforated.

Material:

- Sheet steel

Surface finish:

- Spray-finished

Colour:

- Door: RAL 7035
- Comfort handle VX, hinges: RAL 9005

Protection category IP to IEC 60 529:

- IP 20

Supply includes:

- Door, vertically divided, with comfort handle VX for profile half-cylinders with security lock 3524 E, right
- 3 x 180° hinges, fitted on each half of the door
- Assembly parts

Note:

- Door opening angle for stand-alone siting: max. 240°
- Door opening angle when baying: max. 160°

For enclosures		Packs of	Model No.
Width mm	Height mm		
800	2000	1 pc(s).	5301.652



Assembly instruction:

- For a door opening angle of 180° when baying, a 180° baying hinge is required, see page 951



Doors/locks

Door variants



Protective bar

As an alternative to a door, e.g. in sealed switch rooms. Prevents people from falling into the open enclosure frame. Easily removable for maintenance purposes. For 1200 mm enclosure width; may be shortened or divided for other sizes.

Material:

- Wood, spray-finished, RAL 3000

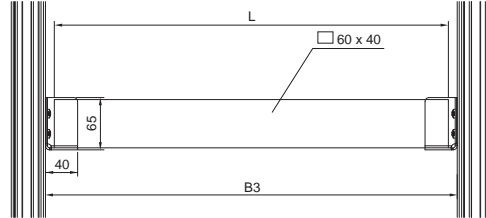

For enclosure width mm	Length mm	Packs of	Model No.
1200	1090	1 pc(s).	8801.010

Enclosure width mm	Clearance between the enclosure frame (B3) mm	Length of protective bar (L) mm
400	311	290 ¹⁾
600	511	490 ¹⁾
800	711	690 ¹⁾
1000	911	890 ¹⁾
1200	1111	1090

¹⁾ The protective bar 8801.010 (1090 mm) will need to be shortened



Also required:

- Holder 8801.000, see page 924



Holder

for protective bar

For mounting on the vertical section. The protective bar is simply inserted.

Material:

- Sheet steel

Surface finish:

- Zinc-plated

Supply includes:

- Assembly screws

Packs of	Model No.
2 pc(s).	8801.000



Variable modular climate control concept

Instead of an enclosure door in a 600 mm/800 mm/1200 mm wide and 1800 mm/2000 mm high VX enclosure, section doors with integral cooling module may be retrofitted without major assembly work.



Possible alternative:

- Modular climate control concept, see page 506/507

Installation accessories for modular front design

Modular front design

Suitable for 400 to 1200 mm wide enclosures instead of a door or rear panel.

The partial doors with and without viewing panels for the baying enclosure system VX25, see page 132/133, may be combined with one another as required. A trim panel is required at the top and bottom in each case.

The requirements for your individual front design and the considerations which must be taken into account are illustrated on the sample configuration opposite.

- 1 Front trim panel, top
- 2 Front trim panel, bottom
- 3 Partial door with viewing window
- 4 Partial door

Note:

Installation accessories for modular front design, see page 926 – 927



Doors/locks

Installation accessories for modular front design



Partial door

for VX

The door may be optionally hinged on the right or left. The partial door is attached to the enclosure with no drilling required. Standard double-bit lock insert may be exchanged for lock inserts, type A.

Material:

- Partial door: Sheet steel, 2 mm
- Viewing window: 3 mm single-pane safety glass

Surface finish:

- Textured paint

Colour:

- RAL 7035

Protection category IP to IEC 60 529:

- IP 54

Supply includes:

- Cross member, hinges and lock components
- Assembly parts

Note:

- Opening angle of partial doors max. 130°



Also required:

- Front trim panel, top, see page 927 or top-hinged trim panel, see page 928
- Front trim panel, bottom, see page 927



Accessories:

- Mini-comfort handle AX for partial door from a height of 200 mm, see page 940
- Lock inserts, type A, see page 941
- Perforated mounting strip, see page 927

For enclosure width 400 mm

Height mm	With viewing window	Number of locks	Packs of	Model No.
200	–	1	1 pc(s).	9682.142
300	–	1	1 pc(s).	9682.143
400	–	2	1 pc(s).	9682.144
600	–	2	1 pc(s).	9682.146
800	–	2	1 pc(s).	9682.148
1000	–	3	1 pc(s).	9682.140
1200	–	3	1 pc(s).	9682.152
1400	–	3	1 pc(s).	9682.154
1600	–	4	1 pc(s).	9682.156
1800	–	4	1 pc(s).	9682.158
2000	–	4	1 pc(s).	9682.150

For enclosure width 600 mm

Height mm	With viewing window	Number of locks	Packs of	Model No.
150	–	1	1 pc(s).	9682.161
200	–	1	1 pc(s).	9682.162
300	–	1	1 pc(s).	9682.163
400	–	2	1 pc(s).	9682.164
600	–	2	1 pc(s).	9682.166
600	■	2	1 pc(s).	9682.167
800	–	2	1 pc(s).	9682.168
800	■	2	1 pc(s).	9682.169
1000	–	3	1 pc(s).	9682.160
1200	–	3	1 pc(s).	9682.172
1400	–	3	1 pc(s).	9682.174
1600	–	4	1 pc(s).	9682.176
1800	–	4	1 pc(s).	9682.178
2000	–	4	1 pc(s).	9682.170

For enclosure width 800 mm

Height mm	With viewing window	Number of locks	Packs of	Model No.
150	–	1	1 pc(s).	9682.181
200	–	1	1 pc(s).	9682.182
300	–	1	1 pc(s).	9682.183
400	–	2	1 pc(s).	9682.184
600	–	2	1 pc(s).	9682.186
600	■	2	1 pc(s).	9682.187
800	–	2	1 pc(s).	9682.188
1000	–	3	1 pc(s).	9682.180
1200	–	3	1 pc(s).	9682.192
1400	–	3	1 pc(s).	9682.194
1600	–	4	1 pc(s).	9682.196
1800	–	4	1 pc(s).	9682.198
2000	–	4	1 pc(s).	9682.190

For enclosure width 1000 mm

Height mm	With viewing window	Number of locks	Packs of	Model No.
400	–	2	1 pc(s).	9682.104
600	–	2	1 pc(s).	9682.106
800	–	2	1 pc(s).	9682.108

For enclosure width 1200 mm

Height mm	With viewing window	Number of locks	Packs of	Model No.
400	–	2	1 pc(s).	9682.124
600	–	2	1 pc(s).	9682.126
800	–	2	1 pc(s).	9682.128

Installation accessories for modular front design

Perforated mounting strip

for partial door

For retrospective external mounting. The perforated mounting strips have a 25 mm pitch pattern of holes and may be used for mounting individual accessories such as cable ducts, conduit holders etc. on the rear of the door.

Hole diameter of perforated mounting strip: 4.5 mm

Material:

- Sheet steel, 1 mm

Surface finish:

- Zinc-plated

Supply includes:

- Assembly parts

For enclosure width mm	Length mm	For partial door height mm	Packs of	Model No.
400	198	200 – 800	10 pc(s).	9681.204
600	398	150 – 800	10 pc(s).	9681.206
800	598	150 – 800	10 pc(s).	9681.208

Note:

- For enclosure width 1000 mm you will need: 1 x 9681.204 and 1 x 9681.206
- For enclosure width 1200 mm you will need: 2 x 9681.206



Front trim panel, top

for VX

To finish off the modular front design at the top when using partial doors. The front trim panels may be removed from the outside by unscrewing. The cross member required for mounting is included with the supply of the mounted partial door.

Material:

- Sheet steel, 1.5 mm

Surface finish:

- Textured paint

Colour:

- RAL 7035

Supply includes:

- Front trim panel
- Assembly parts

Solid, protection category IP 54

For enclosure width mm	Height mm	Packs of	Model No.
400	100	1 pc(s).	9682.314
400	300	1 pc(s).	9682.324
600	100	1 pc(s).	9682.316
600	300	1 pc(s).	9682.326
800	100	1 pc(s).	9682.318
800	300	1 pc(s).	9682.328
1000	300	1 pc(s).	9682.320
1200	300	1 pc(s).	9682.322



Front trim panel, bottom

for VX

To finish off the modular front design at the bottom when using partial doors. If version IP 2X is chosen, a roof plate with protection category IP 2X should be selected for top ventilation. The front trim panels may be removed from the outside by unscrewing.

Material:

- Sheet steel, 1.5 mm

Surface finish:

- Textured paint

Colour:

- RAL 7035

Supply includes:

- Front trim panel including cross member
- Assembly parts

Solid, protection category IP 54

For enclosure width mm	Height mm	Packs of	Model No.
400	100	1 pc(s).	9682.334
400	300	1 pc(s).	9682.344
600	100	1 pc(s).	9682.336
600	300	1 pc(s).	9682.346
800	100	1 pc(s).	9682.338
800	300	1 pc(s).	9682.348
1000	100	1 pc(s).	9682.330
1000	300	1 pc(s).	9682.340
1200	100	1 pc(s).	9682.332
1200	300	1 pc(s).	9682.342

Vented, protection category IP 2X

For enclosure width mm	Height mm	Packs of	Model No.
400	300	1 pc(s).	9682.354
600	300	1 pc(s).	9682.356
800	300	1 pc(s).	9682.358
1000	300	1 pc(s).	9682.350
1200	300	1 pc(s).	9682.352

Also required:

Roof plate IP 2X, see page 961

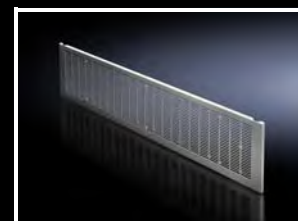
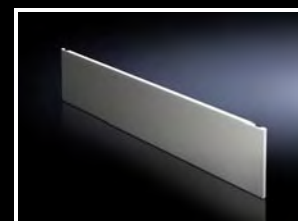

Doors/locks

Installation accessories for modular front design



Trim panel, hinged at the top

For the installation of control and display components, in conjunction with

- Modular front design
- Protective bar

Material:

- Sheet steel, 2 mm

Surface finish:

- Textured paint

Colour:

- RAL 7035

Supply includes:

- Hinges, cam locks with double-bit insert and assembly parts

Width mm	Height mm	Packs of	Model No.
600	300	1 pc(s).	8620.500
800	300	1 pc(s).	8620.501
1200	300	1 pc(s).	8620.502

+ Accessories:

- Stay for trim panel, hinged at the top, see page 928
- Lock inserts, type A, see page 941



Drawer

For mouse and keyboard with a maximum width of 500/700 mm. A high level of protection is retained, even with the flap open.

Material:

- Sheet steel

Colour:

- RAL 7035

Supply includes:

- Flap and assembly parts
- Cross member

Height mm	Width mm	Model No.
200	600	8620.520
200	800	8620.521

+ Accessories:

- Lock inserts, type A, see page 941



Support stay

for trim panel, hinged at the top

5 pitch pattern positions up to a maximum opening angle of approx. 85°.

Material:

- Sheet steel

Surface finish:

- Zinc-plated

Packs of	Model No.
2 pc(s).	8801.260

Viewing window/operating panel

System window

To cover display and operating elements or cut-outs, and to protect against dirt and liquids as well as unauthorised access.

Consisting of the following 2 components:

1. Base frame:

- Easily screw-fastened to the door thanks to modified dimensions (tubular door frame may be used as a drilling template)
- Readily height-adjustable
- Stabilises the door cut-out
- Conceals the cut edge
- The rain canopy
 - prevents dirt from landing on the seal
 - protects the glass from being lifted out
 - prevents the ingress of dirt, and prevents moisture from running behind the window when opened
- Frame section height 30 mm or 60 mm

2. Viewing window:

- Made from single-pane safety glass:
 - High level of resistance to solvents and scratches
 - Anti-static
 - Reduced risk of injury if broken
- Cam lock with double-bit insert, may be exchanged for lock inserts, type A, see page 941
- Hinge with 180° opening angle, easily inserted

Material:

- Extruded aluminium sections with die-cast zinc corner pieces and single-pane safety glass

Surface finish:

- Base frame: Powder-coated in RAL 7035
- Hinge and lock section: Natural-anodised

Protection category IP to IEC 60 529:

- IP 54

30 section

To fit enclosure width mm	Window dimensions, external mm		Model No.
	W	H	
600	500	270	2735.500
		370	2735.510
		470	2735.520
		570	2735.530
		670	2735.540
800	700	270	2735.560
		370	2735.570
		470	2735.580
		570	2735.590
		670	2735.250

60 section

To fit enclosure width mm	Window dimensions, external mm		Model No.
	W	H	
600	500	370	2736.510
		470	2736.520
		570	2736.530
		670	2736.540
800	700	670	2736.500

Note:

- Not suitable for outdoor siting

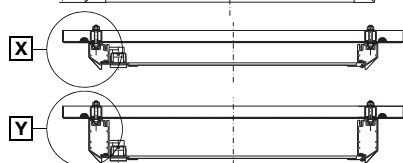
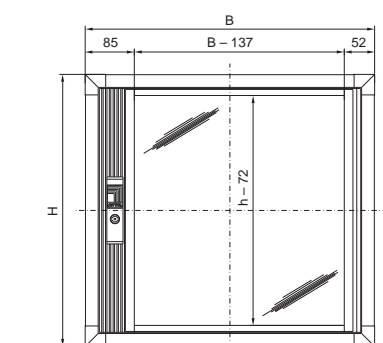

Viewing area (B-137) offset by 16.5 mm towards the hinge side

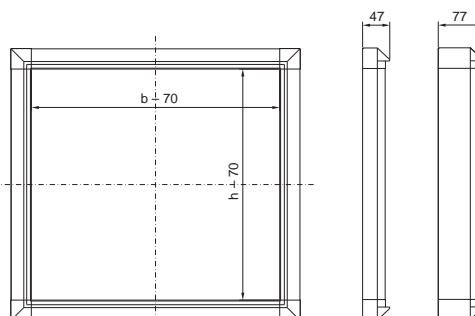

View X
for section height 30

View Y
for section height 60

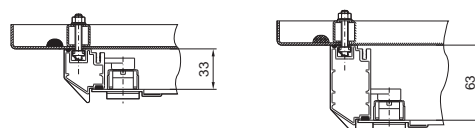

Doors/locks

Viewing window/operating panel

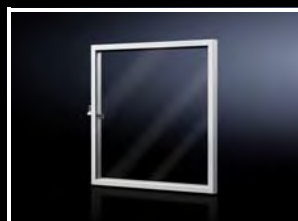

Viewing window

- For mounting on
- AX enclosures instead of the door
 - Surfaces

Max. installation depth: Depth - 4 mm

Visible area:
(Width - 60 mm) x (Height - 60 mm)

Material:

- Frame: Aluminium, natural anodised
- Glazed panel: Acrylic

Protection category IP to IEC 60 529:

- IP 54

Supply includes:

- Plastic handle with lock insert no. 3524 E

Depth 36 mm

For use as door variant with	Width mm	Height mm	Model No.
1050.000, 1350.000, 1007.000, 1013.000	497	497	2733.010
1039.000, 1339.000, 1009.000	597	377	2730.010
1010.000, 1054.000, 1060.000, 1360.000	597	597	2731.010
1012.000, 1076.000, 1376.000	597	757	2732.010

Depth 62 mm

For use as door variant with	Width mm	Height mm	Model No.
1050.000, 1350.000, 1007.000	497	497	2763.010
1039.000, 1339.000, 1009.000	597	377	2760.010
1010.000, 1054.000, 1060.000, 1360.000	597	597	2761.010
1012.000, 1076.000, 1376.000	597	757	2762.010

Acrylic glazed cover

With security lock, lock no. 3524 E.

Material:

- Frame:
Extruded aluminium sections with die-cast corner pieces
- Glazed panel: Smoked acrylic

Protection category IP to IEC 60 529:

- IP 54

Acrylic glazed covers, 482.6 mm (19")

U	Width mm	Height mm	Depth mm	Model No.
3	320	158	47.5	2780.000
3	534	158	47.5	2781.000
6	534	291.5	47.5	2782.000
9	534	425	47.5	2796.000

Max. installation depth: 43 mm

Visible area:
(Width - 40 mm) x (Height - 20.5 mm)

Metric acrylic glazed covers

Width mm	Height mm	Depth mm	Model No.
400	200	47.5	2784.000
400	400	47.5	2785.000
500	200	47.5	2786.000
500	400	47.5	2787.000
600	200	47.5	2788.000
600	400	47.5	2789.000

Max. installation depth: 43 mm

Visible area:
(Width - 40 mm) x (Height - 20.5 mm)

Viewing window/operating panel

Viewing window

Stainless steel

Fitted as standard with internal 130° hinges and all-round seal. The double-bit lock insert may be exchanged for 27 mm lock inserts, type A.

Material:

- Stainless steel 1.4301 (AISI 304)
- Single-pane safety glass

Protection category IP to IEC 60 529:

- IP 54

Supply includes:

- Assembly parts

Width mm	Height mm	Depth mm	Model No.
522	600	38	2793.560



Accessories:

- Lock inserts 27 mm, type A, see page 941

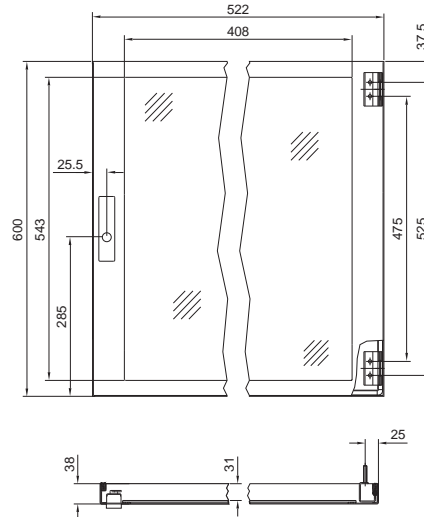

Operating panel

For mounting on

- AX enclosures instead of the door
- Surfaces

Frame construction with a 3 mm aluminium plate secured from the inside.

Material:

- Aluminium, natural anodised

Protection category IP to IEC 60 529:

- IP 54

Supply includes:

- Aluminium frame
- Display panel
- Hinges
- Brackets

For use as door variant for AX	Width mm	Height mm	Depth mm	Model No.
1004.000 1011.000 1031.000	377	297	36	2741.010
1006.000 1303.000 1380.000	377	377	36	2742.010
1008.000 1038.000 1338.000	377	597	36	2743.010
1007.000 1013.000 1050.000 1350.000	497	497	36	2745.010
1009.000 1039.000 1339.000	597	377	36	2744.010
1010.000 1060.000 1304.000 1360.000	597	597	36	2746.010
For surfaces	197	297	36	2740.010

Area available for population:
(Width - 70 mm) x (Height - 70 mm)

Dimensions of aluminium plate:
(Width - 54 mm) x (Height - 54 mm)



Accessories:

- Cam lock 2749.100, see page 932

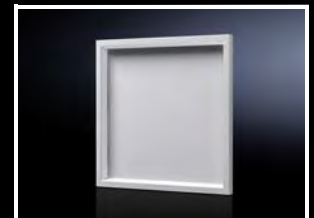

Doors/locks

Viewing window/operating panel



Cam lock

for operating panel

May be retrofitted to the operating area or enclosure wall of operating panels. Standard double-bit insert may be exchanged for lock inserts, type C.

Packs of	Model No.
1 pc(s).	2749.100



Accessories:

- Lock inserts, type C, see page 941



Identification strip

For individual field identifiers on the door, including transparent cover and assembly parts.

For labels:

Width: Enclosure width - 150 mm

Height: 29 mm

Thickness: 0.75 mm

Colour:

- RAL 7035

For enclosure width mm	Model No.
600	8618.450
800	8618.451

Small enclosures, compact enclosures and operating housings AX, sheet steel

		Enclosure series					
		E-Box KX	Compact enclosure AX/AX IT		Operating housings with handle strips AX	Plastic enclosure AX	EL 3-part
Application		With cam	With cam	With 3-point lock	With cam	With cam	3 – 15 U
	from page	65	85	89	179	94	715
Handle systems for enclosures							
Comfort handle AX							
For lock inserts or profile half-cylinders	939	–	–	■	–	–	–
With security lock insert E1	939	–	–	■	–	–	–
For padlock and lock inserts or profile half-cylinders	939	–	–	■	–	–	–
Mini-comfort handle AX							
For lock inserts or profile half-cylinders	940	■	■	–	■	–	–
For padlock and lock inserts or profile half-cylinders	940	■	■	–	■	–	–
Mini-comfort handle for AX plastic							
For lock inserts or profile half-cylinders	941	–	–	–	–	■	–
Mini-comfort handle for 3-part EL enclosures							
For lock inserts	949	–	–	–	–	–	■
For profile half-cylinders	949	–	–	–	–	–	■
Lock inserts for enclosures							
Lock inserts							
Type A	941	■	■	■	■	■	–

Lock inserts for handle systems				
Profile half-cylinders		Lock inserts		
Lock and push-button inserts	DIN 18 252	Type A	Type F	Lock and push-button inserts
942	942	941	941	942
■	■	■	–	–
–	–	–	–	–
■	■	■	–	–
■	■	■	–	–
■	■	■	–	–
■	–	–	■	–
■	■	–	–	–

Console systems, industrial workstation, Comfort Panel and Optipanel, sheet steel

Application	Enclosure series								
	TopConsole TP		One-piece console TP		Universal console TP	IW	Comfort Panel	Optipanel	from page
	Desk section and console	Pedestal	Console cover	Console door					
	157	157	161	161	162	167	172	174	

Lock inserts for handle systems				
Profile half-cylinders		Lock inserts		
Lock and push-button inserts	DIN 18 252	Type A	Type F	Lock and push-button inserts
942	942	941	941	942

Handle systems for enclosures

Comfort handle for VX SE, PC, IW, EL									
For lock inserts	938	-	-	-	-	-	■	-	-
For padlock and lock inserts	938	-	-	-	-	-	■	-	-
For profile half-cylinders	938	-	-	-	-	-	■	-	-

Comfort handle AX									
For lock inserts or profile half-cylinders	939	-	■	-	■	■	-	-	-
With lock insert, lock E1	939	-	■	-	■	■	-	-	-
For padlock and lock inserts or profile half-cylinders	939	-	■	-	■	■	-	-	-

T handles									
Type B	943	■	-	■	-	-	-	-	-
Type C	943	-	-	-	-	-	-	■	■

Plastic handles									
Type B	942	■	-	■	-	-	-	-	-
Type C	942	-	-	-	-	-	-	■	■

Lock inserts for enclosures

Lock inserts									
Type A	941	■	■	■	■	■	-	-	-
Type F	941	-	-	-	-	-	■	-	-

Lock cylinder inserts									
Type B	943	-	-	-	-	-	■	-	-

-	-	-	■	■
-	-	-	■	■
■	■	-	-	-
■	■	■	-	-
-	-	-	-	-
■	■	■	-	-

Doors/locks

Allocation of lock systems

Enclosures and cases, stainless steel

Application	Page	Enclosure series					
		E-Box KX	AX		One-piece console TP	VX	VX SE
With cam	With 3-point lock		Console cover				
	233	237	240	251	243	249	

Handle systems for enclosures

Comfort handle VX							
For lock inserts, stainless steel, precision-cast	937	-	-	-	-	■	-
For profile half-cylinders, stainless steel, precision-cast	937	-	-	-	-	■	-
Comfort handle for VX SE, PC, IW, EL							
For lock inserts, matt chrome	938	-	-	-	-	-	■
For profile half-cylinders, matt chrome	938	-	-	-	-	-	■
Comfort handle AX							
For lock inserts or profile half-cylinders, stainless steel, precision-cast	939	-	-	■	-	-	-
Mini-comfort handle AX							
For lock inserts or profile half-cylinders	940	■	■	-	-	-	-
For padlock and lock inserts or profile half-cylinders	940	■	■	-	-	-	-
Plastic handle							
Type C	942	-	-	-	■	-	-
T handle							
Type C	943	-	-	-	■	-	-

Lock inserts for enclosures

Lock inserts							
Type A	941	■	■	■	-	-	-
Type C	941	-	-	-	■	-	-
Type F	941	-	-	-	-	-	■
Type G	941	-	-	-	-	■	-
Cam lock, stainless steel							
With double-bit insert, stainless steel 1.4404 (AISI 316L)	943	■	■	-	-	-	-
Lock cylinder inserts							
Type C	943	-	-	-	■	-	-

Lock inserts for handle systems					
Profile half-cylinders		Lock inserts			
Lock and push-button inserts	DIN 18 252	Type A	Type F	Type G	Lock and push-button inserts
942	942	941	941	941	942

-	-	-	-	■	■
■	■	-	-	-	-
-	-	-	■	-	■
■	■	-	-	-	-
■	■	■	-	-	-
■	■	■	-	-	-





Comfort handle VX

for VX, VX IT

As the handle does not take up any swing space, due to its folding action, the door surface area available for installed equipment is maximised. Simple assembly, thanks to the snap-mounted handle system.

Prepared for the installation of lock inserts, lock and push-button inserts or for the installation of standard commercially available 40 or 45 mm profile half-cylinders.



					
	For lock inserts	For padlock and lock inserts	With security lock insert E1 ¹⁾	For profile half-cylinders	Prepared for ASSA lock system
	Model No.				
Die-cast zinc RAL 7035	8618.200	8618.230	8618.240	8618.250	8618.270
Die-cast zinc RAL 9005	8618.201	8618.231	–	8618.251	–
Precision-cast stainless steel	8618.220	–	–	8618.280	–
Lock inserts, type G					
7 mm square	8618.300	8618.300	–	–	–
8 mm square	8618.301	8618.301	–	–	–
7 mm triangular	8618.302	8618.302	–	–	–
8 mm triangular	8618.303	8618.303	–	–	–
Screwdriver	8618.304	8618.304	–	–	–
Daimler insert	8618.305	8618.305	–	–	–
3 mm double-bit	8618.306	8618.306	–	–	–
Fiat	8618.307	8618.307	–	–	–
6.5 mm triangular	8618.308	8618.308	–	–	–
Lock and push-button inserts					
Lock insert, lock no. 3524 E ²⁾	8611.180	8611.180	–	2467.000	–
Push-button insert	8611.190	8611.190	–	2468.000	–
Push-button and lock insert ²⁾	8611.200 ³⁾	8611.200 ³⁾	–	2469.000 ⁴⁾	–
Profile half-cylinders					
To DIN 18 252 ⁵⁾	–	–	–	9785.040 ⁷⁾	–
	–	–	–	9785.042 ⁶⁾	–

¹⁾ Only for use with VW, Audi, SEAT, SkodaAuto, supplied without key

²⁾ With 2 keys

³⁾ Lock no. 12321, no other lock is possible

⁴⁾ Lock no. 2123, no other lock is possible

⁵⁾ With 3 keys for each lock insert

⁶⁾ Packs of two, simultaneous locking within the same pack, no simultaneous locking for different packs

⁷⁾ Lock-specific key

Locking bar latch to CNOMO¹⁾

for VX

To fit all locking bars in doors and glazed doors with standard lock or comfort handle VX. The latch prevents the locking bars from moving when the door is open.

¹⁾ CNOMO is a French automobile industry standard. For safety reasons, it must not be possible to lock the handle whilst the door is open.

Packs of	Model No.
10 pc(s).	8618.460

! Also required:

- For CNOMO¹⁾ lock inserts, type G, 6.5 mm triangular insert 8618.308, see page 941



Doors/locks

Lock systems



Comfort handle

for VX SE, PC, IW, EL

As the handle does not take up any swing space, due to its folding action, the door surface area available for installed equipment is maximised.

Prepared for the installation of lock inserts, lock and push-button inserts or for the installation of standard commercially available 40 or 45 mm profile half-cylinders.





Also required:

- Handle adaptor, see page 918, for mounting on glazed door for VX SE, PC bottom door, IW designer door

Note:

- When replacing the comfort handle in the wall-mounted enclosure EL, 3-part with 21 U, please note that the handle can only be replaced as a complete system (handle including lock insert)
- The comfort handle 8611.020 is included with the supply of the enclosure

			
	For lock inserts	For padlock and lock inserts	For profile half-cylinders
	Model No.		
Die-cast zinc RAL 7035	8611.020	8611.290	8611.070
Matt chrome	8611.330	–	8611.340
Lock inserts, type F			
7 mm square	8611.100	8611.100	–
8 mm square	8611.110	8611.110	–
7 mm triangular	8611.120	8611.120	–
8 mm triangular	8611.130	8611.130	–
Screwdriver	8611.140	8611.140	–
Daimler insert	8611.150	8611.150	–
3 mm double-bit	8611.160	8611.160	–
Fiat	8611.170	8611.170	–
6.5 mm triangular	8611.220	8611.220	–
Lock and push-button inserts			
Lock insert, lock no. 3524 E ¹⁾	8611.180	8611.180	2467.000
Push-button insert	8611.190	8611.190	2468.000
Push-button and lock insert ¹⁾	8611.200 ²⁾	8611.200 ²⁾	2469.000 ³⁾
Profile half-cylinders			
to DIN 18 252 ⁴⁾	–	–	9785.040 ⁶⁾
	–	–	9785.042 ⁵⁾

¹⁾ With 2 keys

²⁾ Lock no. 12321, no other lock is possible

³⁾ Lock no. 2123, no other lock is possible

⁴⁾ With 3 keys for each lock insert

⁵⁾ Packs of two, simultaneous locking within the same pack, no simultaneous locking for different packs

⁶⁾ Lock-specific key

Comfort handle AX

for compact enclosures AX with 3-point lock system, TE, TP, swing frame, large

The unlocked handle folds out forwards, and the lock is opened by swivelling.

Prepared for the installation of lock inserts or for the installation of standard commercially available 40 or 45 mm profile half-cylinders, as well as lock and push-button inserts.

			
	For lock inserts or profile half-cylinders	With security lock insert E1 ¹⁾	For padlocks and lock inserts or profile half-cylinders
	Model No.		
Die-cast zinc RAL 7035	2435.100	2435.200	2435.400
Precision-cast stainless steel	2435.300	-	-
Lock inserts, type A			
7 mm square	2460.000	-	2460.000
8 mm square	2461.000	-	2461.000
7 mm triangular	2462.000	-	2462.000
8 mm triangular	2463.000	-	2463.000
Screwdriver	2464.000	-	2464.000
Daimler insert	2465.000	-	2465.000
3 mm double-bit	2466.000	-	2466.000
Fiat	2307.000	-	2307.000
6.5 mm triangular	2460.650	-	2460.650
Lock and push-button inserts			
Lock insert, lock no. 3524 E ²⁾	2467.000	-	2467.000
Push-button insert	2468.000	-	2468.000
Push-button and lock insert ²⁾	2469.000 ³⁾	-	2469.000 ³⁾
Profile half-cylinders			
to DIN 18 252 ⁴⁾	9785.040 ⁶⁾	-	9785.040 ⁶⁾
	9785.042 ⁵⁾	-	9785.042 ⁵⁾

¹⁾ Only for use with VW, Audi, SEAT, SkodaAuto, supplied without key

²⁾ With 2 keys.

³⁾ Lock no. 2123; no other lock is possible

⁴⁾ With 3 keys for each lock insert

⁵⁾ Packs of two, simultaneous locking within the same pack, no simultaneous locking for different packs

⁶⁾ Lock-specific key



Doors/locks

Lock systems



Mini-comfort handle AX

for AX/AX IT with cam lock, KX with cam lock, partial doors for modular front design

The lock is opened by swivelling the unlocked handle.

Prepared for the installation of lock inserts or for the installation of standard commercially available 40 or 45 mm profile half-cylinders, as well as lock and push-button inserts.

		
	For lock inserts or profile half-cylinders	For padlocks and lock inserts or profile half-cylinders
	Model No.	
Die-cast zinc RAL 7035	2537.100	2537.300
Lock inserts, type A		
7 mm square	2460.000	2460.000
8 mm square	2461.000	2461.000
7 mm triangular	2462.000	2462.000
8 mm triangular	2463.000	2463.000
Screwdriver	2464.000	2464.000
Daimler insert	2465.000	2465.000
3 mm double-bit	2466.000	2466.000
Fiat	2307.000	2307.000
6.5 mm triangular	2460.650	2460.650
Lock and push-button inserts		
Lock insert, lock no. 3524 E ¹⁾	2467.000	2467.000
Push-button insert	2468.000	2468.000
Push-button and lock insert ¹⁾	2469.000 ²⁾	2469.000 ²⁾
Profile half-cylinders		
to DIN 18 252 ³⁾	9785.040 ⁵⁾	9785.040 ⁵⁾
	9785.042 ⁴⁾	9785.042 ⁴⁾

¹⁾ With 2 keys.

²⁾ Lock no. 2123; no other lock is possible

³⁾ With 3 keys for each lock insert

⁴⁾ Packs of two, simultaneous locking within the same pack, no simultaneous locking for different packs

⁵⁾ Lock-specific key

Mini-comfort handle AX

for AX plastic

The lock is opened by swivelling the unlocked handle.

Prepared for the installation of lock inserts or for the installation of standard commercially available 40 or 45 mm profile half-cylinders, as well as lock and push-button inserts.

Packs of	Model No.
1 pc(s).	1485.600
Lock inserts, type A	
7 mm square	2460.000
8 mm square	2461.000
7 mm triangular	2462.000
8 mm triangular	2463.000
Screwdriver	2464.000
Daimler insert	2465.000
3 mm double-bit	2466.000
Fiat	2307.000
6.5 mm triangular	2460.650
Lock and push-button inserts	
Lock insert, lock no. 3524 E ¹⁾	2467.000
Push-button insert	2468.000
Push-button and lock insert ¹⁾	2469.000 ²⁾
Profile half-cylinders	
to DIN 18 252 ³⁾	9785.040 ⁵⁾
	9785.042 ⁴⁾

¹⁾ With 2 keys.

²⁾ Lock no. 2123; no other lock is possible

³⁾ With 3 keys for each lock insert

⁴⁾ Packs of two, simultaneous locking within the same pack, no simultaneous locking for different packs

⁵⁾ Lock-specific key

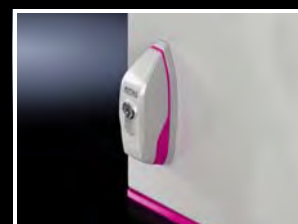





Lock inserts

for handles and enclosures



Accessories:

- Enclosure key, see page 945

Type	A	C	F	G
				
Material	Die-cast zinc	Die-cast zinc	Die-cast zinc	Die-cast zinc
Length	27 mm	41 mm		
	Model No.			
7 mm square	2460.000	2523.000	8611.100	8618.300
8 mm square	2461.000	2526.000	8611.110	8618.301
7 mm triangular	2462.000	2527.000	8611.120	8618.302
8 mm triangular	2463.000	2528.000	8611.130	8618.303
Screwdriver	2464.000	-	8611.140	8618.304
Daimler insert	2465.000	2522.000	8611.150	8618.305
3 mm double-bit	2466.000	2483.000	8611.160	8618.306
Fiat	2307.000	-	8611.170	8618.307
6.5 mm triangular	2460.650	-	8611.220	8618.308

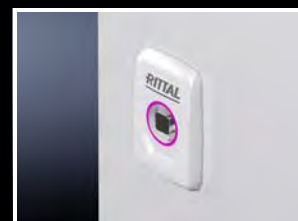

Doors/locks

Lock systems

Lock inserts

for installation in comfort handle,
mini-comfort handle



Lock and push-button inserts

Installation options:

- In comfort handle VX for lock inserts
- In mini-comfort handle for VX SE, IW, PC for lock inserts
- In mini-comfort handle for EL for lock inserts

	Model No.
Security lock insert, lock no. 3524 E ¹⁾	8611.180
Push-button insert	8611.190
Push-button and lock insert ¹⁾	8611.200²⁾

¹⁾ With two keys

²⁾ Lock no. 12321; no other lock is possible



Lock and push-button inserts and profile half-cylinders

Installation options:

- In comfort handle VX for profile half-cylinders
- In comfort handle AX
- In mini-comfort handle AX
- In mini-comfort handle AX for AX plastic
- In mini-comfort handle for EL for profile half-cylinder

	Model No.
Security lock insert, lock no. 3524 E ¹⁾	2467.000
Push-button insert	2468.000
Push-button and lock insert ¹⁾	2469.000²⁾
Profile half-cylinders to DIN 18 252 ³⁾	9785.040⁵⁾
	9785.042⁴⁾

¹⁾ With two keys

²⁾ Lock no. 2123; no other lock is possible

³⁾ With 3 keys for each lock insert

⁴⁾ Packs of two, simultaneous locking within the same pack, no simultaneous locking for different packs

⁵⁾ Lock-specific key







Plastic handles

With or without lock cylinder insert.

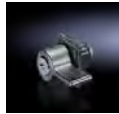
Supply includes:

- Assembly parts and seal

Type	B		C	
				
	With lock cylinder insert, lock no. 3524 E ¹⁾	Without lock cylinder insert	With lock cylinder insert, lock no. 3524 E ¹⁾	Without lock cylinder insert
Installation in	Console lid TP, sheet steel		Console lid TP, stainless steel Comfort Panel Optipanel	
	Model No.			
RAL 9011	2576.000	2533.000	2485.000	2485.100





¹⁾ With two keys

T handles

With or without lock cylinder insert.

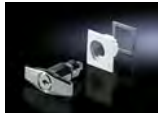
Supply includes:

- Seal

Type	B		C	
				
	With lock cylinder insert ¹⁾	Without lock cylinder insert	With lock cylinder insert ¹⁾	Without lock cylinder insert
Installation in	Console lid TP, sheet steel		Console lid TP, stainless steel Comfort Panel Optipanel	
	Model No.			
	2575.000²⁾	2572.000	2535.000²⁾	2536.000

¹⁾ With 2 keys

²⁾ Lock no. 3524 E



Cam lock, stainless steel

for AX, KX E-Box

With double-bit insert.

Material:

- Made entirely from stainless steel 1.4404 (AISI 316L)

For	Packs of	Model No.
AX	1 pc(s).	2304.100
KX E-Box	1 pc(s).	2309.110



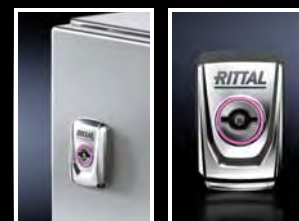

Accessories:

- Lock inserts, type A, see page 941



Lock cylinder inserts

Type	B	C
		
	With lock no. 3524 E ¹⁾	With lock no. 3524 E ¹⁾
Installation in	IW	Console lid TP, stainless steel
Material	Die-cast zinc	Die-cast zinc
	Model No.	
	2571.000	2525.000

¹⁾ With two keys



Doors/locks

Lock systems



Multiple lock

for 6 padlocks

The ideal solution in cases where several people need individual access for maintenance and repair purposes.

Material:

- Sheet steel

Surface finish:

- Zinc-plated

Packs of	Model No.
2 pc(s).	2493.500



Lock cover

for AX/AX IT, prepared for a lead seal

For retrospective mounting on all compact enclosures AX, sheet steel, with cam lock.

Material:

- Polyamide

Colour:

- RAL 7035

Packs of	Model No.
2 pc(s).	2476.100



Safety lock

Fitted to doors, to protect against contact with live electrical equipment whilst the master switch is ON.

Function:

- Locks the door when the master switch is ON.
- Mains power (voltage) is only enabled whilst the door is closed.
- Monitoring of the lock magnet via an additional closing contact.

Supply includes:

- Lock
- Actuator
- Angle bracket
- Assembly parts

Connection voltage for lock magnet	Model No.
230 V AC 11 VA	2416.000
24 V DC 8 W	2418.000
120 V AC 8 VA	2419.000







Also required:

- For twin-door enclosures (for the overlapping door, to indicate "enclosure door closed"): Door-operated switch 4127.010, see page 1024

Enclosure key

For lock inserts. Enclosure, case and lock systems are supplied as standard with matching keys.

				
	Model No.			
	-	-	2549.000	2549.500²⁾³⁾
Double-bit no. 5	2531.000	-	■	■
Security lock no. 3524 E	-	2532.000¹⁾	-	-
7 mm triangular	2545.000	-	-	■
8 mm triangular	2546.000	-	■	■
7 mm square	2547.000	-	-	■
8 mm square	2548.000	-	■	■
For HD locks	2549.600	-	-	-
For Daimler	2521.000	-	-	-
For Fiat	2308.000	-	-	-

¹⁾ Packs of 2

²⁾ With bit adaptor and reversible bit for: Multi-tooth size 25 and 30

³⁾ Bit 2549.510 for HD lock insert, see page 224



Doors/locks

Lock systems



Comfort handle VX

with numerical code, for VX, VX IT

Flexible access opportunities with individual 4-digit code.

Benefits:

- Enhanced security by automatically wiping the code after use
- Emergency opening and overwriting of the code is possible with a 40 mm profile half-cylinder to DIN 18 252

Functional principle:

- The 4-digit code may be set individually by the user
- Programming mode can only be accessed via the set code
- Once the code has been entered or used, it is automatically reset to the digits "0000" and thus cannot be read by a third person once the handle has been opened
- May be opened in an emergency situation or if the code is forgotten using the master key function with key

Dimensions:

- W x H x D: 41 x 386 x 46 mm, door-mounted

Material:

- Die-cast zinc
- Plastic

Colour:

- RAL 9005

Protection category IP to IEC 60 529:

- IP 30

Packs of	Model No.
1 pc(s).	7030.601

Supply includes:

- Comfort handle for profile half-cylinders
- Handle adaptor for VX IT aluminium glazed door and VX IT aluminium sheet steel door, vented (door hinge on right/left)
- Assembly parts



Also required:

- Profile half-cylinders, see page 942



Accessories:

- Mounting adaptor for TS 8 doors, see page 948



CMC III online comfort handle VX

with master key function for VX, VX IT

For door locking, handle lever monitoring and status display. It can be opened directly via a 24 V DC supply voltage or connected to the CMC III via the CMC III Access Control.

Benefits:

- Remote control and an extensive range of functions for automated access control by linking to the CMC III, e.g. activation via an optional coded lock or transponder reader
- Optical LED status display of the handle or superordinate CMC III system in the rack
- Individual activation and colour selection configurable via the CMC III
- Prepared for use of a 40 mm profile half-cylinder to DIN 18 252

Technical specifications:

- Rated voltage: 24 V DC
- Rated current: 100 mA

Dimensions:

- W x H x D: 41 x 386 x 42 mm, door-mounted

Material:

- Die-cast zinc
- Plastic

Colour:

- RAL 9005

Protection category IP to IEC 60 529:

- IP 30

Packs of	Model No.
1 pc(s).	7030.611

Supply includes:

- Comfort handle for profile half-cylinders
- Connection cable RJ12, 2.9 m
- Handle adaptor for VX IT aluminium glazed door and VX IT aluminium sheet steel door, vented (door hinge on right/left)
- Assembly parts



Also required:

- Profile half-cylinders, see page 942



Accessories:

- CMC III access control, see page 812
- CMC III Processing Unit/Compact, from page 804
- CMC III coded lock VX, see page 813
- CMC III transponder reader VX, see page 813

Radio comfort handle VX

with card reader for VX, VX IT

Battery operated radio handle for door locking, handle lever/rack door monitoring and status display.

Benefits:

- Supports remote control via radio by linking to CMC III
- Stand-alone operation supported
- Easily retrofitted without any machining thanks to radio technology
- Optical LED status display of the handle or superordinate CMC III system in the rack
- Individual activation and colour selection configurable via CMC III
- Service life of the integral batteries is up to 2 years.
- Supports use of the handle without radio technology, connection to CMC III via optional online adaptor
- High standard of security thanks to encrypted radio transmission of security-relevant signals using Advanced Encryption Standard 128 Bit (AES 128)

Functional principle:

- Battery operation: EnOcean 868 MHz radio technology with encryption
- Operation with CMC III: Up to 128 radio handles on one CMC III system
- Stand-alone operation: Handle settings via master card or Android app "Access Control VX" with NFC-enabled smartphone
- Supports emergency opening via an integral USB-C-slot, transponder handle and external power supply
- Integral transponder card reader for Legic Advant, HID, FeliCa and NFC via Android app (Legic Prime available on request)
- Integral monitoring of lever handle
- Integral rack door monitoring of the handle position with a compass signal or infrared sensor

Dimensions:

- W x H x D: 41 x 377 x 27 mm, door-mounted

Material:

- Die-cast zinc
- Plastic

Colour:

- RAL 9005

Protection category IP to IEC 60 529:

- IP 30

Supply includes:

- Handle
- 2 batteries, type CR123A
- Handle adaptor for VX IT aluminium glazed door and VX IT aluminium sheet steel door, vented (door hinge on right/left)
- 1 Mifare classic transponder card
- Assembly parts

Packs of	Model No.
1 pc(s).	7030.621

Max. number of radio comfort handles/sensors

Wireless Units	Processing Unit Compact	Processing Unit
16	0	128

Operating modes/transponder cards

Operating mode	Setting of user cards	Max. number of user cards per handle
Stand-Alone	Master card	10
Stand-Alone	Android App + Master card	50
CMC III via radio	CMC III	1000



Also required:

- Only for remote control via the CMC III: CMC III Wireless Unit, see page 815
CMC III Processing Unit/-Compact, from page 804



Accessories:

- Transponder card, see page 814
- Online adaptor for radio comfort handle, see page 948
- VX mounting adaptor for TS 8 doors, see page 948



Doors/locks

Lock systems



Mounting adaptor

for comfort handle VX with numerical code, radio comfort handle VX

For mounting VX handles on doors

Colours:

- RAL 9005

Supply includes:

- Adaptor
- Coupling element
- Adaptor for TS glazed aluminium door
- Assembly parts

To fit enclosure type	Packs of	Model No.
TS 8	1 pc(s).	7030.692



Online adaptor

for radio comfort handle VX

For converting the VX radio comfort handle to a wired solution. The adaptor is inserted into the VX radio comfort handle instead of the batteries.

Application:

- Deactivation of radio technology

Functional principle:

- Control via connection cable and 24 V DC power supply instead of batteries
- Connection to CMC III access control system is also optionally supported

Technical specifications:

- Rated voltage: 24 V DC
- Rated current: 100 mA

Dimensions:

- W x H x D: 34 x 33 x 21 mm

Material:

- Plastic

Supply includes:

- Connection cable RJ12, 2.9 m

Packs of	Model No.
1 pc(s).	7030.624



Also required:

- Radio comfort handle VX, see page 947



Accessories:

- CMC III access control, see page 812
- CMC III Processing Unit/Compact, from page 804



Cable routing kit for doors

VX, VX IT

For optimised cable routing on the inside of the VX enclosure system doors when using a CMC III handle.

Benefits:

- The duct cover and the ring cable holder may be shortened to any desired length

Functional principle:

- When installing handles or reader units with cables, these will need to be laid close to the inside of the door. The cables are routed in the aluminium extrusion of the doors.
- To close the duct, the duct cover simply snaps onto the profile.
- For cable routing with ventilated or sheet steel doors, the ring cable holder is glued to the inside of the door.

Material:

- Plastic

Colour:

- Pale grey

Packs of	Model No.
1 pc(s).	7030.695



Supply includes:

- Duct cover, 2 m
- 4 ring cable holders, 0.5 m
- Assembly parts

Mini-comfort handle

for EL 3-part, , 3 – 15 U

Prepared for the installation of lock inserts or for the installation of standard commercially available 40 or 45 mm profile half-cylinders, as well as lock and push-button inserts.

		
	For lock inserts	For profile half-cylinders
	Model No.	
Die-cast zinc RAL 7035	7705.110	7705.120
Lock inserts, type F⁶⁾		
7 mm square	8611.100	–
8 mm square	8611.110	–
7 mm triangular	8611.120	–
8 mm triangular	8611.130	–
Screwdriver	8611.140	–
Daimler insert	8611.150	–
3 mm double-bit	8611.160	–
Fiat	8611.170	–
6.5 mm triangular	8611.220	–
Lock and push-button inserts		
Lock insert, lock no. 3524 E ¹⁾	8611.180	2467.000
Push-button insert	8611.190	2468.000
Push-button and lock insert ¹⁾	8611.200 ²⁾	2469.000 ³⁾
Profile half-cylinders		
to DIN 18 252 ⁴⁾	–	9785.040 ⁷⁾
	–	9785.042 ⁵⁾

¹⁾ With 2 keys

²⁾ Lock no. 12321, no other lock is possible

³⁾ Lock no. 2123, no other lock is possible

⁴⁾ With 3 keys for each lock insert

⁵⁾ Packs of two, simultaneous locking within the same pack, no simultaneous locking for different packs

⁶⁾ Replacement of the complete system only (handle including lock inserts)

⁷⁾ Lock-specific key

Ergoform-S handle

with numerical code, for TE

Flexible access options thanks to individual 3-digit numerical code without key, or via the master key function with the additional use of 40 or 45 mm profile half-cylinders to DIN 18 252, independently of the code.

Colour	Packs of	Model No.
RAL 7035	1 pc(s).	7200.810

Accessories:

- Profile half-cylinders, see page 942
- Lock inserts, type A, see page 941



Doors/locks

Lock systems



Ergoform-S handle

electromagnetic, for TE

For door locking and handle lever monitoring. If the 24 V DC voltage supply is applied, the handle cannot be opened with the push-button insert. The handle may be connected to the CMC III via the CMC III access control and activated in this way. The push-button insert may be replaced with a lock insert or a profile half-cylinder, 40 or 45 mm to DIN 18 252.

Technical specifications:

- Rated voltage: 24 V DC
- Rated current: 100 mA

Supply includes:

- Handle including cable 0.4 m
- Push-button insert
- Connection cable RJ12, 3 m

Colour	Packs of	Model No.
RAL 7035	1 pc(s).	7320.700

+ Accessories:

- Profile half-cylinders, see page 942
- Lock inserts, type A, see page 941
- CMC III access control, see page 812
- CMC III Processing Unit/Compact, see page 804



180° hinges

Supply includes:

- Assembly parts

Note:

- The protection category of the enclosure may be reduced
- Door hinge remains the same within a bayed enclosure suite

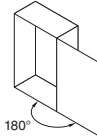
Enclosure type	Door variant	Material	Colour	Packs of		
					Model No.	
VX25	Sheet steel door	Steel/precision-cast	RAL 7035	4 pc(s).	8618.330¹⁾	
	Stainless steel door	Stainless steel/precision-cast	–	4 pc(s).	8618.335¹⁾	
VX SE	Sheet steel door	Die-cast zinc	RAL 7035	4 pc(s).	8800.190	
			Matt nickel-plated		8701.180	
VX SE	Doors with high dynamic loads, door installations up to 900 N	Precision casting/die-cast zinc	RAL 7035	4 pc(s).	8800.710	
VX IT bayed enclosure suites with comfort handle	Sheet steel doors	Die-cast zinc	RAL 7035 RAL 9005	4 pc(s).	5301.400	
	Aluminium doors	Die-cast zinc	RAL 9005		5301.401	
AX/AX IT	Sheet steel door	Die-cast zinc	–	3 pc(s).	2449.010	

¹⁾ May be mounted without machining the door, suitable for door installations up to 900 N



Cover hinge

for terminal boxes KX

The cover hinge is simply screw-fastened to the enclosure protection channel and to the edge fold. The position of the installation holes is prepunched, so no need to measure and mark out.

Supply includes:

- Cover hinge
- Stoppers
- Assembly parts

Material	Packs of	Model No.
Die-cast zinc	6 pc(s).	1592.200
Stainless steel 1.4404 (AISI 316L)	2 pc(s).	1592.210



Doors/locks

Door, internal



Support strip

For attachment of

- Cable ducts
- Cable conduit holders
- Contact hazard protection covers
- Equipment installed on the door
- Cable clamping and attachment

4.5 mm diameter hole on a 25 mm DIN pitch pattern

For VX, VX SE, AX plastic, TP, PC, IW

Installation options:

- In VX, VX SE, PC, IW on tubular door frame
- TP on perforated door strip
- In AX plastic on mounting boss in the door

For AX

Installation options:

- In AX sheet steel in the enclosure door with cam lock
- In AX stainless steel in enclosure door with cam lock in conjunction with perforated door strip

Material:

- Sheet steel

Surface finish:

- Zinc-plated

Supply includes:

- Assembly parts



Accessories:

- Screws and self-tapping screws M5, see page 1004

For door width mm	Distance between attachment points mm	Packs of	Model No.
400	275	20 pc(s).	4594.000
500	375	20 pc(s).	4309.000
600	475	20 pc(s).	4596.000
800	675	20 pc(s).	4598.000
900	775	20 pc(s).	4579.000
1000	875	20 pc(s).	4599.000

For door width mm	Distance between attachment points mm	Packs of	Model No.
380	305	20 pc(s).	4599.100
400	325	20 pc(s).	4694.000
500	425	20 pc(s).	4695.000
600	525	20 pc(s).	4696.000
760	685	20 pc(s).	4599.200
800	725	20 pc(s).	4697.000



Also required:

- For installation in AX stainless steel: AX perforated door strip, stainless steel, see page 953

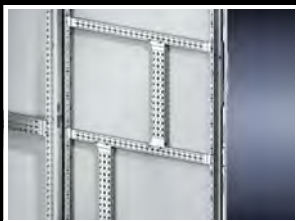
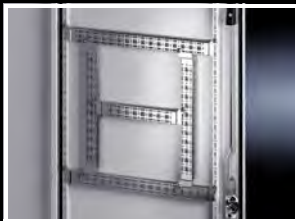

Punched section with mounting flange, 14 x 39 mm

for door installation, for VX, VX SE, AX, AX plastic, PC, IW

Secure location and fast mounting on the tubular door frame.

For attaching

- Cable ducts
- Cable conduit holders
- Equipment installed on the door, etc.

Installation options:

- In VX, VX SE, PC, IW on tubular door frame
- In AX sheet steel in the enclosure door with 3-point lock system in the lockable door
- In AX stainless steel in enclosure door with 3-point lock system in the lockable door in conjunction with perforated door strip
- In AX plastic on mounting boss in the door

Material:

- Sheet steel

Surface finish:

- Zinc-plated

Supply includes:

- Assembly parts

For door width mm	Distance between attachment points mm	Packs of	Model No.
400	275	4 pc(s).	8619.700
500	375	4 pc(s).	8619.710
600	475	4 pc(s).	8619.720
800	675	4 pc(s).	8619.730
900	775	4 pc(s).	8619.740
1000	875	4 pc(s).	8619.750



Also required:

- For installation in AX stainless steel: AX perforated door strip, stainless steel, see page 953



Accessories:

- Screws and self-tapping screws M5 for configuring the customer's own components on the punched section with mounting flange, see page 1004

Doors/locks

Door, internal

Spacers

The universal assembly component for all situations where a distance from the mounting level is required. With self-tapping thread for 4.5 mm diameter holes. The following components may be attached to the rear using 5.5 x 13 mm screws:

- Top-hat / cross rails
- Contact hazard protection covers
- Master switch trim panels
- Cable clamp rails
- etc.

Material:

- Hexagonal steel (SW8)

Surface finish:

- Zinc-plated



Accessories:

- Screws 5.5 x 13 mm, see page 1004

Length mm	Packs of	Model No.
25	12 pc(s).	2311.225
50	12 pc(s).	2311.250

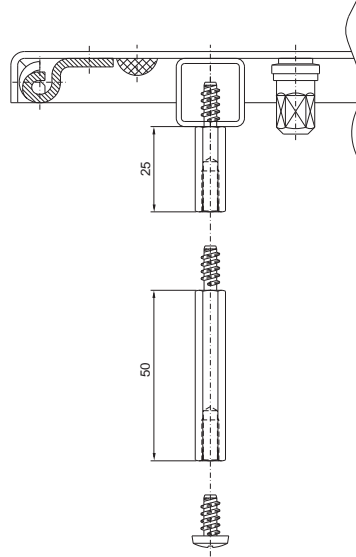

Perforated door strip

for AX stainless steel

For vertical mounting on the threaded bolts of the door.

For attaching

- Support strips
- Punched section with mounting flange, 14 x 39 mm
- Door stay

Material:

- Sheet steel

Surface finish:

- Zinc-plated

For door height mm	Packs of	Model No.
760	2 pc(s).	2311.076
1000	2 pc(s).	2311.100
1200	2 pc(s).	2311.120



Accessories:

- Support strip, see page 952
- Punched section with mounting flange, 14 x 39 mm, see page 952
- Door stay, see page 956
- Screws, see page 1004



Utility lectern

for VX, VX SE, TP, PC

For programming units etc., prepared for mounting on the tubular door frame. When required for servicing, it folds out quickly with a maximum support area, and after use is lowered between the tubular door frames in a space-saving design.

Load capacity:

- Max. 300 N

Material:

- Sheet steel

Colour:

- RAL 7035

Support area		For door width mm	Model No.
Width mm	Depth mm		
413	400	600	4638.600
613	400	800	4638.800



Doors/locks

Door, internal



Wiring plan lectern

for VX, VX SE, TP, PC

Holds wiring plans during fault-finding and maintenance work. Wiring plan lecterns may be bayed in line with the door width. For mounting on the tubular door frame.

Material:

- Utility lectern: Polypropylene
- Mounting bracket: Die-cast zinc

Colour:

- Similar to RAL 7035

Supply includes:

- Wiring plan lectern (width 210 mm)
- Assembly parts

Packs of	Model No.
1 pc(s).	4120.000

For door width mm	Required/possible number of wiring plan lecterns	
	min.	max.
400	1	1
500	1	1
600	2	2
800	2	3
1000	3	3

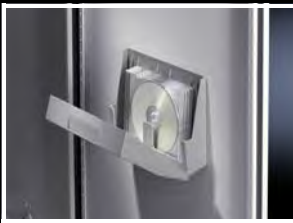

Storage box

For fixing to all flat, clean surfaces with double-sided adhesive tape. Secure storage of CDs/DVDs, small parts such as fuses etc.

Capacity:

- Max. 10 CDs/DVDs

Material:

- Polyamide

Colour:

- RAL 7035

Packs of	Model No.
1 pc(s).	2446.000

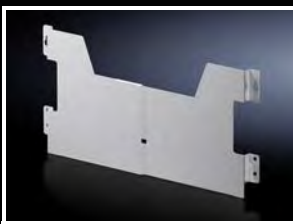

Wiring plan pocket, sheet steel

width-variable, for AX

For fastening to the perforated door strip at any height. Variable and easily adjustable in the width.

Depth: 35 mm

Colour:

- RAL 7035

Supply includes:

- Assembly screws

To fit door width mm	Clearance opening mm		Model No.
	Width	Height	
400, 500	325 - 425	210	2515.200
600	475 - 575	210	2515.300
760, 800	625 - 725	210	2515.400



Also required:

- For installation in AX stainless steel:
AX perforated door strip, stainless steel, see page 953

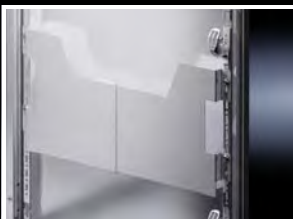

Wiring plan pocket, sheet steel

for VX, VX SE, TP pedestal, PC

For fastening to tubular door frames at any height.

Colour:

– RAL 7035

Supply includes:

– Assembly parts

D = 90 mm

To fit door width mm	Clearance opening mm		Model No.
	W	H	
400	255	210	4114.000
500	355	210	4115.000
600	455	210	4116.000
800	655	210	4118.000
900	755	210	4123.000
1000	855	210	4124.000

D = 35 mm

To fit door width mm	Clearance opening mm		Model No.
	W	H	
500	355	210	4115.500
600	455	210	4116.500
800	655	210	4118.500



Plastic wiring plan pocket

For adhering to surfaces.

Material:

– Polystyrene with self-adhesive fastening strips

Colour:

– Similar to RAL 7035

For format	Clearance opening mm			Model No.
	W	H	D	
A3 landscape	438	286	45	2513.000
A4 portrait	228	254	17	2514.000
A5 landscape	228	174	17	2515.000



Wiring plan pocket with transparent pouch

With welded-on transparent pouch and self-adhesive backing.

For format	Model No.
A4	2510.000
A3	2512.000



Doors/locks

Door, internal

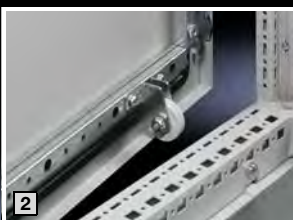
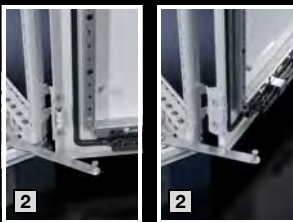
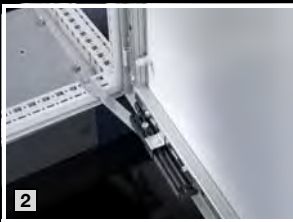
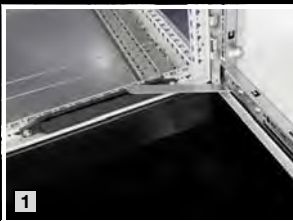
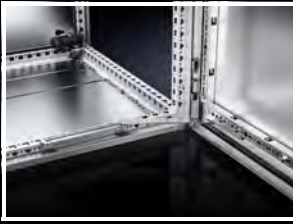

Door stay

To secure the door in the open position. May be fitted without machining the enclosure/housing.

Supply includes:

- Assembly parts

For	Mounting	Packs of	Model No.
VX	bottom	1 pc(s).	8618.430
VX SE, TP universal console, PC	bottom	5 pc(s).	4583.000
TP	top	2 pc(s).	2519.200
AX sheet steel AX stainless steel	top	1 pc(s).	2519.010



Also required:

- For installation in AX sheet steel:
AX rail for interior installation in the appropriate depth, see page 989
- For installation in AX stainless steel:
AX perforated door strip, stainless steel, see page 953

Door stay for escape routes

In an emergency situation, conventional door stays could block the escape route. The stay is activated automatically by pressure, releasing the door in both directions. In conjunction with 180° hinges, this ensures that no escape routes are blocked by open doors in the event of an emergency.

Supply includes:

- Assembly parts

For	Packs of	Model No.
1 VX	1 pc(s).	8618.425
2 VX SE, PC	1 pc(s).	4583.500



Accessories:

- 180° hinge, see page 951

Ride-up roller

for door VX, VX SE, PC

Lifts up the door when there is heavy installed equipment (e.g. cooling unit) as a closing aid. For attaching to the tubular door frame.

For	Packs of	Model No.
1 VX	10 pc(s).	8618.420
2 VX SE, PC	10 pc(s).	4538.000

Doors/locks

Door, internal

Shipping brace

for door VX

To stabilise the door when transporting from an additional weight load of 15 kg.

Material:

- Plastic

Colour:

- RAL 7035

Supply includes:

- Assembly parts

Packs of	Model No.
10 pc(s).	8618.410



Transport and mounting handle

for doors VX, VX SE

For safe installation and removal of the door and during relocation in the workshop.

Packs of	Model No.
1 pc(s).	2415.100



Document clip, magnetic

For simple attachment of installation documentation as a reminder or for flexible accommodation of a wide range of documents, measurement records, test reports etc. May be attached to any magnet-compatible surface via a permanent magnet.

Material:

- Plastic

Colour:

- Clip: Transparent
- Handle pieces: Black

Packs of	Model No.
2 pc(s).	7950.200



Alternate frame, magnetic

For individual marking or labelling of the existing network infrastructure. The magnetic surface facilitates flexible mounting on all magnet compatible surfaces. Adhesive strips are supplied for non-magnetic surfaces. The maximum size of the labels is 130 x 50 mm.

Packs of	Model No.
10 pc(s).	7950.150

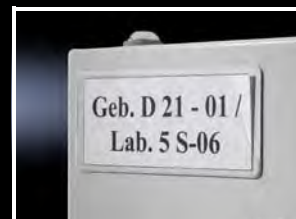

Roof/wall mounting

Roof

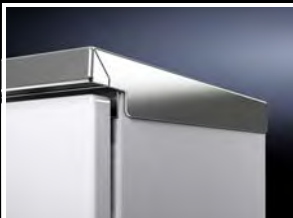
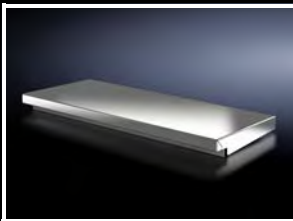

Outdoor housing

for compact enclosures AX

- For use outdoors
- For creating an enclosure-within-an-enclosure concept
- Cut-out at the bottom and integrated louvres in the side and base for optimum enclosure ventilation

Material:

- Aluminium AlMg3

Surface finish:

- Powder-coated

Note:

- Depending on the application/environment, a sheet steel or stainless steel enclosure may be built into the housing

Housing W x H x D mm	For AX enclosures W x H x D mm	Packs of	ModelNo.
421 x 550 x 308	300 x 400 x 210	1 pc(s).	9792.055
621 x 650 x 308	500 x 500 x 210	1 pc(s).	9792.065
721 x 750 x 448	600 x 600 x 350	1 pc(s).	9792.075



Also required:

- Wall mounting bracket for AX, sheet steel, see page 966
- or wall mounting bracket for AX, stainless steel, see page 967



Accessories:

- Pole clamp, see page 968

Protective roof

for AX

The sloping protective roof reliably protects the enclosure from standing moisture and other soiling from above.

Material:

- Stainless steel 1.4301 (AISI 304)

Surface finish:

- Brushed, grain size 240

Supply includes:

- Assembly parts

For		H mm	Model No.
Enclosure width mm	Enclosure depth T mm		
300	210	37	2361.010
380	210	37	2472.010
500	210	37	2362.010
600	210	37	2473.010
600	350	47	2476.010
760	300	43	2474.010
800	300	43	2475.010
1000	300	43	2363.010

Side view

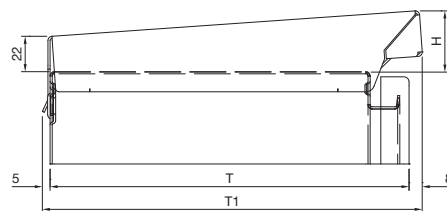

$T1 = \text{Enclosure depth } T + 13 \text{ mm}$

Rear view

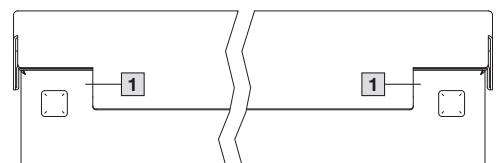

1 Recess for wall mounting bracket

Roof/wall mounting

Roof

Dust guard trim

for AX, KX

To protect against deposits on the upper edge of the door and between the enclosure and the door/cover. Cut the dust guard trim to length according to the enclosure width. Drill the enclosure and fit the dust guard trim using the adhesive strips and screws.

Material:

- Plastic, UV-resistant

Colour:

- Similar to RAL 7024

Supply includes:

- Assembly parts

For enclosure	Length mm	A mm	Model No.
AX	1200	21.5	2426.500
KX		21	

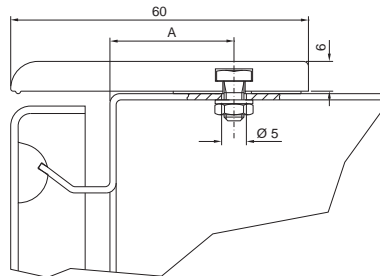

Dust guard trim

for VX, VX SE

To protect against dust deposits on the upper edge of the door and between the door and upper horizontal enclosure section. The dust guard trim provides space for texts or company logos.

Colour:

- RAL 7035

Supply includes:

- Clear plastic strip for text labels (height 29.5 mm)
- Assembly parts

Length mm	Model No.
600	2424.100
800	2425.100
1000	2427.100
1200	2426.100

Note:

- Also suitable for use in conjunction with top baying cover, see page 915



Roof/wall mounting

Roof

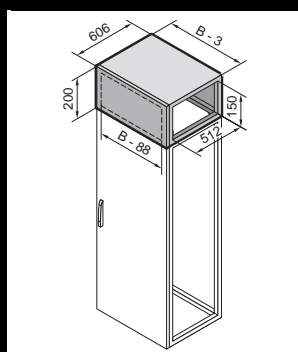

Top-mounting module

As a cable chamber for cable infeed from above, or for power distribution with busbar systems across bayed enclosures. The cover plate supplied as standard is used to finish off at the top. The enclosure height is increased by 200 mm with the top-mounting module fitted. Installation accessories for top and bottom, see diagram and explanations below.

Material:

- Sheet steel, 1.5 mm

Surface finish:

- Spray-finished, textured paint

Colour:

- RAL 7035

Protection category IP to IEC 60 529:

- IP 55

Protection category NEMA:

- NEMA 12

For enclosures		Packs of	Model No.
Width (B) mm	Depth mm		
600	600	1 pc(s).	8618.501
800	600	1 pc(s).	8618.511
1000	600	1 pc(s).	8618.521
1200	600	1 pc(s).	8618.531

Supply includes:

- 1 frame module
- 2 trim panels (front and rear)
- 8 retainers with automatic potential equalisation
- Assembly parts



Also required:

- Side panel for top-mounting module 8618.541, see page 960



Accessories:

Description	Page
1 Punched section with mounting flange 23 x 64 mm (for the inner level)	991
2 Punched rail 18 x 39 mm	993
3 Support rail 75 x 20 mm	996
4 Support rail 48 x 26 mm	996
5 C rail 30/15	996
6 Cable clamp rail	1059

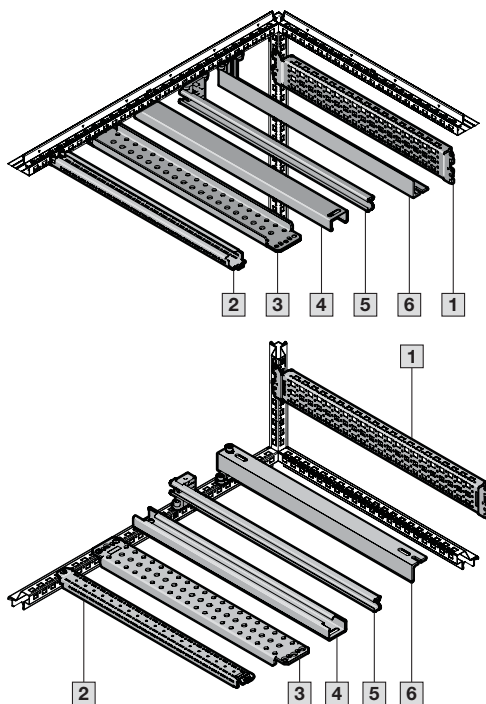

Side panel

for top-mounting module

To finish off the side of a top-mounting module or bayed suite.

Material:

- Sheet steel, 1.5 mm

Surface finish:

- Spray-finished, textured paint

Colour:

- RAL 7035

Supply includes:

- Assembly parts

Packs of	Model No.
2 pc(s).	8618.541

Roof/wall mounting

Roof

Roof plate IP 55, solid

for VX, VX IT

For enclosures without roof plate and in exchange for the standard roof.

Material:

– Sheet steel, 1.5 mm

Surface finish:

– Textured paint

Colour:

– RAL 7035

Protection category IP to IEC 60 529:

– IP 55

Supply includes:

– Assembly parts

For enclosures		Packs of	Model No.
Width mm	Depth mm		
400	600	1 pc(s).	9681.646
400	800	1 pc(s).	9681.648
600	600	1 pc(s).	9681.666
600	800	1 pc(s).	9681.668
600	1000	1 pc(s).	9681.660
600	1200	1 pc(s).	9681.662
800	600	1 pc(s).	9681.686
800	800	1 pc(s).	9681.688
800	1000	1 pc(s).	9681.680
800	1200	1 pc(s).	9681.682

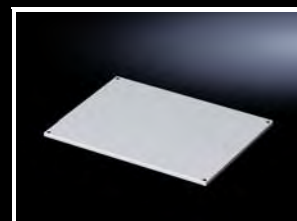

+ **Accessories:**

- Pressure stoppers, see page 962
- Eyebolt, see page 964

Roof plate IP 2X with ventilation hole

for VX, VX IT

For enclosures without roof plate and in exchange for the standard roof.

Material:

– Sheet steel, 1.5 mm

Surface finish:

– Textured paint

Colour:

– RAL 7035

Protection category IP to IEC 60 529:

– IP 2X

Supply includes:

– Assembly parts

For enclosures		Build height mm	Packs of	Model No.
Width mm	Depth mm			
400	600	72	1 pc(s).	9681.846
400	800	72	1 pc(s).	9681.848
600	600	72	1 pc(s).	9681.866
600	800	72	1 pc(s).	9681.868
800	600	72	1 pc(s).	9681.886
800	800	72	1 pc(s).	9681.888
1000	600	72	1 pc(s).	9681.806
1000	800	72	1 pc(s).	9681.808
1200	600	72	1 pc(s).	9681.826
1200	800	72	1 pc(s).	9681.828



Roof plate for cable entry glands

for VX, VX IT

For enclosures without roof plate and in exchange for the standard roof.

Material:

– Sheet steel, 1.5 mm

Surface finish:

– Textured paint

Colour:

– RAL 7035

Supply includes:

– Assembly parts

For enclosures		Required no. of glands	Packs of	Model No.
Width mm	Depth mm			
400	600	3	1 pc(s).	9681.546
400	800	4	1 pc(s).	9681.548
600	400	2	1 pc(s).	9681.564
600	600	4	1 pc(s).	9681.566
600	800	8	1 pc(s).	9681.568
800	600	8	1 pc(s).	9681.586
800	800	8	1 pc(s).	9681.588
850	400	3	1 pc(s).	9681.594
850	600	6	1 pc(s).	9681.596
1100	400	4	1 pc(s).	9681.514
1100	600	8	1 pc(s).	9681.516



! **Also required:**

- Cable entry gland, see page 962
- Eyebolt, see page 964

Roof/wall mounting

Roof

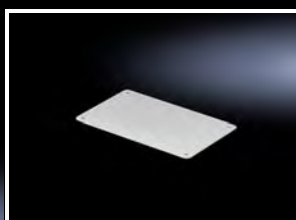
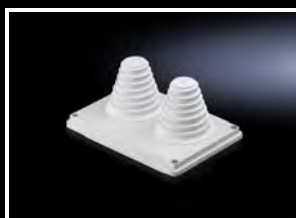

Pressure stoppers

for roof plate

For converting the IP 55 roof plate into a roof plate with pressure relief function. The pressure relief function is essential for compliance with health and safety regulations for arc-proofing to IEC/TR 61 641. After fitting the pressure stopper, a protection category of IP 54 is achieved.

Material:

- Polyamide

Supply includes:

- 2 warning stickers

Note:

- 2 pressure stoppers and 1 warning sticker are required for one roof plate
- The arc-proofing compliance limits are dependent on the busbar system used

Packs of	Model No.
4 pc(s).	9674.790

Cable entry gland

for roof plate

For simple, secure cable entry in the roof zone.

Colour:

- RAL 7035

Protection category IP to IEC 60 529:

- IP 55

Supply includes:

- Seal

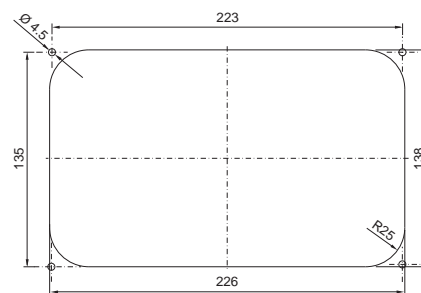

Cut-out dimensions for 9665.750 to 9665.785

Version	Material	Width mm	Depth mm	Packs of	Model No.
14 x M25/32	Insulating material	250	160	1 pc(s).	9665.750
2 x M25/32/40, 1 x M32/40/50, 2 x M40/50/63	Insulating material	250	160	1 pc(s).	9665.760
With sealing membranes 32 x Ø 7 – 16 mm, 4 x Ø 10 – 20 mm, 3 x Ø 14 – 26 mm	Insulating material	250	160	1 pc(s).	9665.770
With entry fittings up to Ø 66 mm	Insulating material	250	160	1 pc(s).	9665.780
Solid	Sheet steel, spray-finished	250	160	4 pc(s).	9665.785

Roof/wall mounting

Roof

Roof plate, two-piece

for cable entry for VX, VX IT

In exchange for the standard roof. Equipped with a sliding angular bracket in the rear section. Rubber cable clamp strip on both sides for attaching cable bundles and bunched cables.

Due to the symmetrical design of the VX frame, side cable entry can also be achieved by rotating the roof plate. The two-piece design allows convenient retrofitting.

Material:

- Sheet steel

Colour:

- RAL 7035

For enclosures		Packs of	Model No.
Width mm	Depth mm		
600	600	1 pc(s).	7826.665
600	800	1 pc(s).	7826.685
600	1000	1 pc(s).	7826.605
800	600	1 pc(s).	7826.865
800	800	1 pc(s).	7826.885
800	1000	1 pc(s).	7826.805
800	1200	1 pc(s).	7826.825

Protection category IP to IEC 60 529:

- IP 20

Supply includes:

- Assembly parts

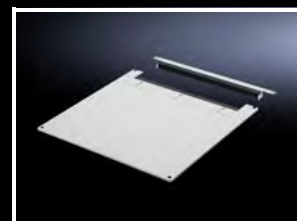

Brush kit for cable entry in the roof

for TE

For cable entry in the roof plate.

Benefits:

- For simple top-mounting on the cut-out edge

Material:

- Plastic support with brushes
- Brush strip: Plastic UL 94-V0
- Bristles: Plastic UL 94-HB

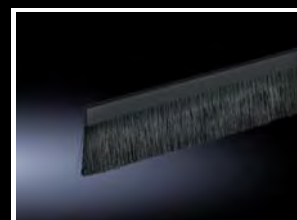

For enclosure width mm	Bristle length mm	Width mm	Length mm	Packs of	Model No.
600	30	19	390	2 pc(s).	7888.610
800	30	19	590	2 pc(s).	7888.612

Cable organiser

for TE open

Cable routing plate for targeted routing of cables.

Applications:

- Optionally on the roof plate of the TE open

Material:

- Sheet steel, spray-finished

Colour:

- RAL 7035

Packs of	Model No.
4 pc(s).	7888.950

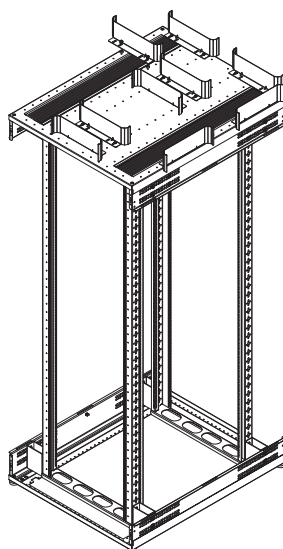

Roof/wall mounting

Roof



Spacers

for roof plate

To raise the roof for ventilation purposes, in three different heights.

Thread: M12

Material:

- Hexagonal sectional steel

Surface finish:

- Zinc-plated

Supply includes:

- Assembly parts

Height mm	Packs of	Model No.
10	4 pc(s).	2422.000
20	4 pc(s).	2423.000
50	4 pc(s).	7967.000



Eyebolt

for VX, VX SE

For transporting enclosures by crane.

Thread: M12

Supply includes:

- 4 eyebolts M12
- 4 serrated sealing washers A 12.5

Material	Packs of	Model No.
Sheet steel, zinc-plated, C 15E	4 pc(s).	4568.000
Stainless steel 1.4301 (AISI 304)	4 pc(s).	4568.500



Eyebolt

for AX

For crane transportation of enclosures, with reinforcement plate to be inserted underneath.

Thread: M12

Supply includes:

- 2 eyebolts
- 2 reinforcement plates

Packs of	Model No.
2 pc(s).	2509.010



Roof/wall mounting

Wall mounting

Wall mounting bracket

for **AX sheet steel, KX sheet steel, AX IT, EL**

For the attachment of sheet steel enclosures.

Benefits:

- Screw-fastened directly from the rear with a self-tapping screw in the enclosure eyelet

Supply includes:

- Assembly parts

Material	Wall distance mm	Packs of	Model No.
Sheet steel, zinc-plated	10	4 pc(s).	1590.010

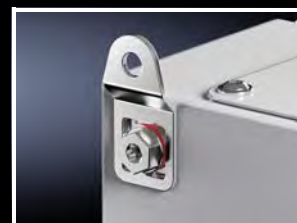

Wall mounting bracket

for **AX stainless steel, KX stainless steel, stainless steel switch housing**

For the attachment of stainless steel enclosures.

Supply includes:

- Assembly parts

Note:

- For hygiene reasons, and in view of the protection category, the stainless steel enclosures do not have any drilled holes for the wall mounting bracket.

Material	Wall distance mm	Packs of	Model No.
Stainless steel 1.4301 (AISI 304)	10	4 pc(s).	1594.010



Roof/wall mounting

Wall mounting



Wall mounting bracket

for AX sheet steel, KX sheet steel, AX IT, EL
Ideal for convenient one-person assembly of wall-mounted enclosures, even in confined spaces.

Benefits:

- Screw-fastened directly from the rear with a self-tapping screw in the enclosure eyelet
- Simply suspend the wall mounting bracket 2508.020, which is equipped with an additional suspension contour, from a screw in the wall
- Different mounting positions allow the wall mounting bracket to be tailored to local conditions on site
- If necessary, the support may be finished with a stylish cover cap
- Additional option of attaching with a nut for dynamic applications

Supply includes:

- Wall mounting bracket
- Cover cap
- Assembly parts

Material	Wall distance mm	Packs of	Model No.
Sheet steel, zinc-plated	20	4 pc(s).	2508.020
	40	4 pc(s).	2503.020

Sample applications

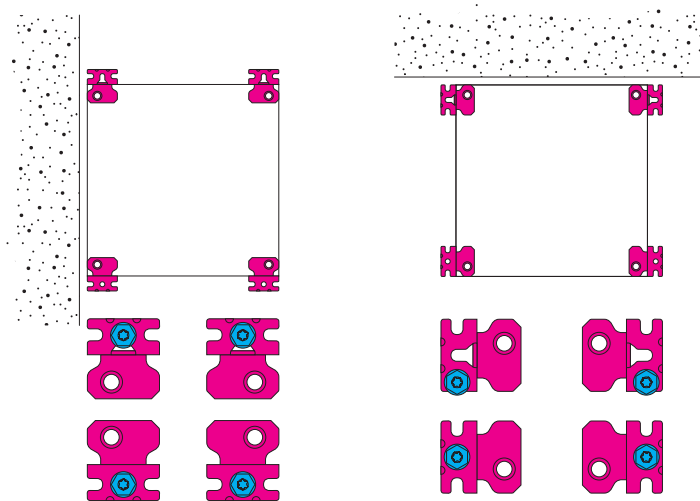

Attachment with self-tapping screw

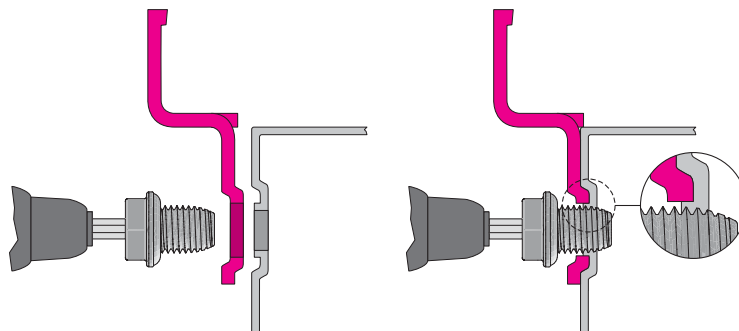

Roof/wall mounting

Wall mounting

Wall mounting bracket

for AX stainless steel, KX stainless steel

For the attachment of AX and KX stainless steel enclosures.

Benefits:

- Simply suspend the wall-mounted bracket from a screw in the wall
- Different mounting positions allow the wall mounting bracket to be tailored to local conditions on site
- If necessary, the support may be finished with a stylish cover cap

Supply includes:

- Wall mounting bracket
- Cover cap
- Assembly parts

Note:

- For hygiene reasons, and in view of the protection category, the stainless steel enclosures do not have any drilled holes for the wall mounting brackets

Material	Wall distance mm	Packs of	Model No.
Stainless steel 1.4301 (AISI 304)	20	4 pc(s).	2433.010
Stainless steel 1.4404 (AISI 316L)	20	4 pc(s).	2433.510



Wall angle

for AX, KX, AX IT

For the attachment of sheet steel and stainless steel enclosures.

Supply includes:

- Assembly parts for mounting on the enclosure

Note:

- Additional holes required in the enclosure

Material	Colour	Packs of	Model No.
Sheet steel	RAL 7035	4 pc(s).	2505.510
Stainless steel 1.4301 (AISI 304)	-	4 pc(s).	2583.010

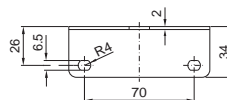
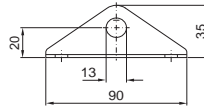

Wall bracket

for VX, VX SE, VX IT

For attaching enclosures with a shallow depth and e.g. heavy components on the door or a built-in swing frame, to a wall at the top.

Material:

- Sheet steel

Surface finish:

- Zinc-plated

Packs of	Model No.
4 pc(s).	4595.000



Roof/wall mounting

Wall mounting



Pole clamp

for AX, KX, AX plastic, AX IT

For reliable, convenient fastening to round or square poles.

- For pole diameter / size:
- Ø from 40 to 170 mm
 - □ from 50 to 150 mm

Material:

- Mounting angles, clamping section: Sheet steel
- Clamping strap: Stainless steel 1.4301 (AISI 304)

Surface finish:

- Mounting angle, clamping section: Zinc-plated

Supply includes:

- 2 mounting angles, 600 mm long
- 4 clamping sections
- 2 clamping straps
- 4 clamping brackets
- Assembly parts

Packs of	Model No.
2 pc(s).	2584.100

Note:

- The pole clamp cannot be used in conjunction with a protective roof for AX

Enclosure connectors

Adjustable

Between command panels, terminal boxes, compact enclosures and horizontal or vertical surfaces. Pre-mount the connector halves on both sides, screw together and secure with a locking screw, and/or adjust the angle of rotation.

Rotation range:

- ±105° adjustable in 7.5° stepped increments

Material:

- Die-cast zinc

Surface finish:

- Powder-coated

Colour:

- RAL 7035

Supply includes:

- Assembly parts for both sides

Packs of	Model No.
2 pc(s).	6016.200

Note:

- The locking screws may be exchanged for standard, commercially available clamping levers (M10 x 50 mm)

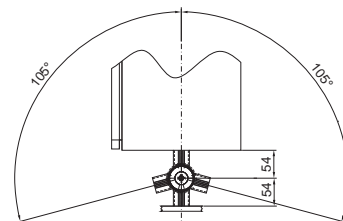

Roof/wall mounting

Wall mounting

Frame connector, adjustable

for Comfort Panel

Between the command panel and keyboard housing and horizontal or vertical surfaces.

Rotation range:

– Adjustable in 8° stepped increments, see drawing

Material:

– Die-cast zinc

Surface finish:

– Powder-coated

Colour:

– RAL 7024

Supply includes:

– Assembly parts and clamping levers for both sides

Packs of	Model No.
2 pc(s).	6005.500

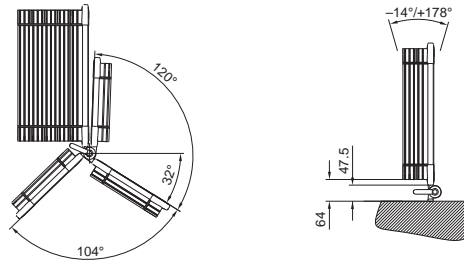

Wall mounting

Vertically hinged

Between the Compact Panel and horizontal or vertical surfaces.

Rotation range:

– 180° adjustable on a 7.2° pitch pattern

Material:

– Wall mounting: Sheet steel

– Knurled screw: Steel with plastic knurled handle

Supply includes:

– Knurled screw and assembly parts for mounting on the Compact Panel

Packs of	Model No.
2 pc(s).	6341.000



Interior installation

Mounting plates



Mounting plate

for terminal boxes KX, bus enclosures KX,
terminal boxes HD, Ex enclosures

For component installation outside of the enclosure.
Assembly screws included as accessories with the enclosure.

Material:

- Sheet steel, 2 mm

Surface finish:

- Zinc-plated



Accessories:

- Self-tapping screws 2487.000, see page 1004



Possible alternative:

- Support rail, see page 997

For size mm	For Model No.	Model No.
150 x 150	1500.000, 1514.000, 1560.000, 1564.000, 1670.600, 1671.600, 9301.000	1560.800
200 x 150	1528.000, 1529.000	1575.800
300 x 150	1501.000, 1515.000, 1530.000, 1561.000, 9302.000	1561.800
400 x 150	1589.000	1576.800
200 x 200	1502.000, 1516.000, 1562.000, 1565.000, 1672.600, 9303.000	1562.800
300 x 200	1503.000, 1517.000, 1531.000, 1563.000, 1566.000, 1674.600, 1583.000, 9304.000	1563.800
400 x 200	1504.000, 1518.000, 1532.000, 1568.000, 1585.000, 1610.000, 1675.600, 9305.000	1564.800
500 x 200	1505.000, 1533.000	1565.800
600 x 200	1506.000, 1586.000	1566.800
800 x 200	1527.000	1574.800
300 x 300	1507.000, 1535.000, 1567.000, 9306.000	1567.800
400 x 300	1508.000, 1536.000, 1569.000, 1611.000, 1676.600	1568.800
500 x 300	1509.000, 1537.000	1569.800
600 x 300	1510.000, 1538.000, 1612.000	1570.800
800 x 300	1613.000	1570.810
400 x 400	1511.000, 1539.000	1571.800
600 x 400	1512.000, 1540.000	1572.800
800 x 400	1513.000, 1541.000	1573.800

Interior installation

Mounting plates

Mounting plate infill

for VX

For a continuous mounting surface in bayed suites where the mounting plate is set forward.

Material:

- Sheet steel, 2 mm

Surface finish:

- Zinc-plated

Supply includes:

- Assembly parts

For enclosure height mm	Packs of	Model No.
1800	1 pc(s).	4590.700
2000	1 pc(s).	4591.700
2200	1 pc(s).	4592.700



Detail	Mounting position of mounting plate	Benefits
	<p>Set forward from the enclosure frame on a 25 mm pitch pattern</p> <p>Position: -25 mm -50 mm -75 mm etc.</p>	<p>The usable mounting width is enlarged by up to 25%, depending on the enclosure selection.</p>

Mounting plate attachment

Type A, for VX

To reduce vibrations in the mounting plate, e.g. in dynamic applications and when transporting with heavy assemblies. Simple mounting directly on the enclosure frame. During installation, the mounting plate latches automatically into the mounting plate attachment. The mounting plate attachment type A keeps the front of the mounting plate completely free for unrestricted use. Populated mounting plates may be mounted from the front without dismantling the rear panel.

Packs of	Model No.
5 pc(s).	8617.353

Material:

- Spring steel

Supply includes:

- Safety clip
- Assembly parts



Detail	Mounting position of mounting plate	Installation option	Attachment to the mounting plate
	<p>Flush with the enclosure frame</p> <p>Position: ± 0 mm, fitted at the rear</p>	<p>Fitted on the left and right of the mounting plate</p>	<p>Latched home</p>
	<p>Flush with the enclosure frame</p> <p>Position: ± 0 mm, fitted at the front</p>	<p>Fitted on the left and right of the mounting plate at half height</p>	<p>Latched home</p>

Interior installation

Mounting plates

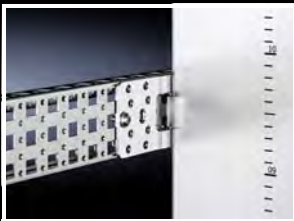

Mounting plate attachment

Type B, for VX

To reduce vibrations in the mounting plate, e.g. in dynamic applications and when transporting with heavy assemblies. Simple mounting directly on the enclosure frame or on the punched section with mounting flange 23 x 64 mm. The mounting plate may optionally be screw-fastened with the mounting plate attachment, or form-fit connected.

Depending on the installation situation, the mounting plate attachment type B either minimally surrounds the mounting plate, or keeps the front of the mounting plate completely free for unrestricted use. May be mounted from the front or the rear, depending on the situation.

Packs of	Model No.
10 pc(s).	8617.351

Material:

- Sheet steel

Surface finish:

- Zinc-plated, passivated

Supply includes:

- Assembly parts



Accessories:

- Punched section with mounting flange 23 x 64 mm for the inner level, see page 991

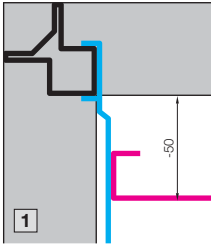
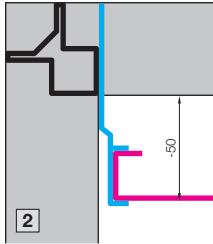
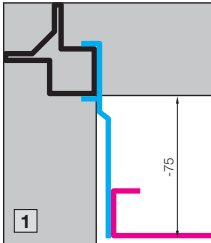
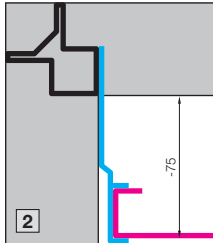
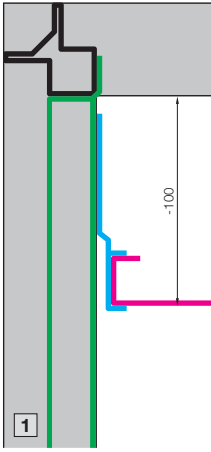
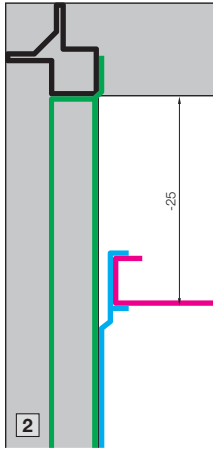
Detail	Mounting position of mounting plate	Installation option	Attachment to the mounting plate
	Set forward from the enclosure frame Position: -50 mm	1 2 pc(s), per enclosure/mounting plate, at the side, half-way up the mounting plate	Screw-fastened
	Set forward from the enclosure frame Position: -50 mm	2 All-round between the enclosure and mounting plate in any quantity	Connected
	Set forward from the enclosure frame Position: -75 mm	1 2 pc(s), per enclosure/mounting plate, at the side, half-way up the mounting plate	Screw-fastened
	Set forward from the enclosure frame Position: -75 mm	2 All-round between the enclosure and mounting plate in any quantity	Connected
	Set forward from the enclosure frame 1 Position: -100 mm or larger	All-round between the enclosure and mounting plate in any quantity. One punched section with mounting flange 23 x 64 mm to match the enclosure depth is required for each mounting plate attachment.	Connected
	2 Position: -25 mm or larger		

Interior installation

Mounting plates

Mounting plate attachment

Type C, for VX

To reduce vibrations in the mounting plate, e.g. in dynamic applications and when transporting with heavy assemblies. Simple mounting directly on the enclosure frame. The mounting plate may be form-fit connected and clamped with the mounting plate attachment. The mounting plate attachment type C keeps the front of the mounting plate completely free for unrestricted use. With the mounting plate installed and the rear panel dismantled, it can be fitted from the rear.

Packs of	Model No.
10 pc(s).	8617.352

Material:

- Sheet steel

Surface finish:

- Zinc-plated, passivated

Supply includes:

- Assembly parts

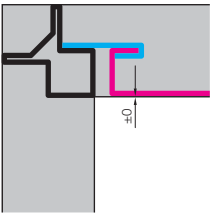
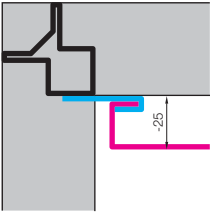
Detail	Mounting position of mounting plate	Installation option	Attachment to the mounting plate
	Flush with the enclosure frame Position: ± 0 mm	All-round between the enclosure and mounting plate in any quantity	Connected, clamped
	Set forward from the enclosure frame Position: -25 mm	All-round between the enclosure and mounting plate in any quantity	Connected, clamped

VX installation kit

for back-to-back mounting plates

The minimum spacing between the mounting plates facilitates maximum assemblies on both mounting plates.

Material:

- Sheet steel

Surface finish:

- Zinc-plated, passivated

Packs of	Model No.
1 pc(s).	8617.360



Also required:

- Second mounting plate, to fit the enclosure dimensions, refer to Rittal list of spares at www.rittal.com



Accessories:

- For enclosures with a rear panel, following may be used for optimum access to the rear mounting plate:
Glazed door instead of rear panel, see page 917
Lockable and adjacent door 8618.120, for enclosure dimensions W x H = 800 x 2000 mm, see page 917

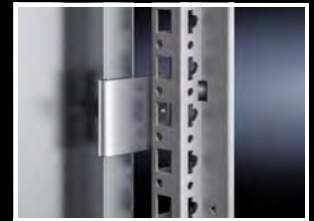
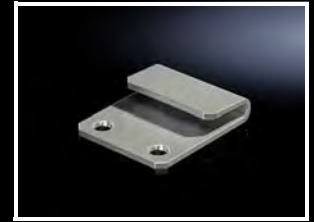

Interior installation

Mounting plates

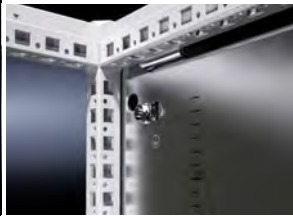

Multi-function mounting kit VX for mounting plate

For installing the mounting plate from the rear of the enclosure

- Mounting position flush with the enclosure frame, position ± 0 mm
- The mounting plate is removable from the front and rear for servicing
- For 20 mm more installation depth in the enclosure
- Mounting position set back behind the enclosure frame, position ± 20 mm

For additional screw-fastening of the mounting plate

- For all mounting positions

Packs of	Model No.
1 pc(s).	8617.370

Material:

- Sheet steel

Surface finish:

- Zinc-plated, passivated

Supply includes:

- Assembly parts

Slide rail

for mounting plates, for VX, VX SE

For sliding the mounting plate in from the side. For mounting in a set-forward position.

Material:

- Sheet steel

Surface finish:

- Zinc-plated

Supply includes:

- Assembly parts

For enclosure width mm	Packs of	Model No.
600	2 pc(s).	8617.400
800	2 pc(s).	8617.401
1200	2 pc(s).	8617.402

Cross-brace

for mounting plates, for VX, VX SE

Additional horizontal rigidity for vibration damping and/or retrospective stabilisation of wide mounting plates. This brace may also be used as an attachment aid for heavy components.

Material:

- Sheet steel

Surface finish:

- Zinc-plated

Supply includes:

- 2 sections
- 4 clamping sections
- 4 grub screws M10 x 16 mm

For enclosure width mm	Model No.
1200	4333.120
1600	4333.160
1800	4333.180

Interior installation

Mounting plates

Partial mounting plate VX

for VX, VX SE, PC, IW

To accommodate additional components inside the enclosure. Partial mounting plates are extremely versatile, providing a platform for a diverse range of applications.

For optional installation either upright as a vertical mounting surface, or flat as a horizontal base. For attachment either directly to the enclosure section or, with a set-forward construction, for example, to any mounting level in the enclosure using punched sections with mounting flanges. For multi-level installation one behind the other, partial mounting plates may be vertically hinged, via hinge attachment 8617.650, to allow rapid access to the levels behind.

Material:

- Sheet steel, 2.5 mm

Surface finish:

- Zinc-plated

Supply includes:

- Assembly parts

Note:

- Depending on the mounting situation, additional parts such as punched sections with mounting flanges may be required, see installation example on page 976



Also required:

- For the installation in VX SE, PC, IW:
Adaptor rail VX, see page 995



Accessories:

- Punched section with mounting flange
18 x 64 mm for the outer level, see page 990
- Punched section with mounting flange
23 x 64 mm for the inner level, see page 991
- Hinge attachment 8617.650, see page 977

Installation examples:

See page 976



For installation in										Door width mm	Dimensions mm	Packs of	Model No.
Enclosure width mm					Enclosure depth (side) mm								
400	600	800	1000	1200	400	500	600	800					
■	■	-	-	-	■	-	■	-	600	500 x 300	1 pc(s).	8617.510	
-	■	-	-	-	-	■	■	-	600	500 x 400	1 pc(s).	8617.520	
-	■	-	-	-	-	-	■	-	600	500 x 500	1 pc(s).	8617.530	
-	■	■	-	-	-	-	■	■	600	500 x 700	1 pc(s).	8617.540	
-	■	-	-	-	-	-	■	-	600	500 x 775	1 pc(s).	8617.550	
■	-	■	-	-	■	-	-	■	800	700 x 300	1 pc(s).	8617.560	
-	-	■	-	-	-	■	-	■	800	700 x 400	1 pc(s).	8617.570	
-	-	■	-	-	-	-	-	■	800	700 x 700	1 pc(s).	8617.580	
■	-	-	■	-	■	-	-	-	1000	900 x 300	1 pc(s).	8617.590	
-	-	-	■	-	-	■	-	-	1000	900 x 400	1 pc(s).	8617.600	
-	■	-	■	-	-	-	■	-	1000	900 x 500	1 pc(s).	8617.610	
■	-	-	-	■	■	-	-	-	-	1100 x 300	1 pc(s).	8617.620	
-	-	-	-	■	-	■	-	-	-	1100 x 400	1 pc(s).	8617.630	
-	■	-	-	■	-	-	■	-	-	1100 x 500	1 pc(s).	8617.640	

Interior installation

Mounting plates

Partial mounting plates VX, installation examples

Full installation in the width/depth

Choose a partial mounting plate 100 mm smaller than the nominal size of the enclosure.
For example, a partial mounting plate with dimensions 500 x 700 mm can be installed in enclosures with nominal dimensions of 600 and 800 mm.

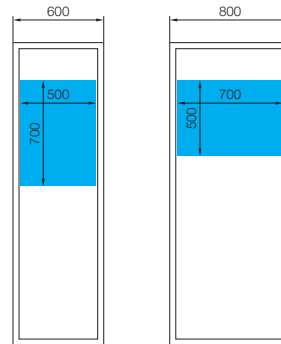

Full installation, set forward in the width/depth

For set-forward installation, punched sections with mounting flanges are required for the inner or outer mounting level, according to the enclosure depth.

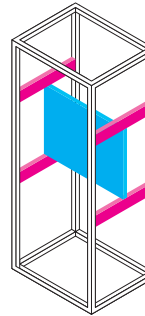

Full installation in the height

The sum total of partial mounting plates 100 mm should be smaller than the nominal size of the enclosure. For example, in a 2000 mm high enclosure, the sum total of partial mounting plates should not exceed 1900 mm.

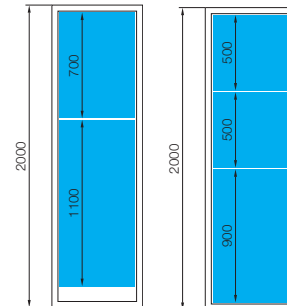

Partial installation



Also required:

- Punched section with mounting flange 23 x 64 mm **(A)** to match the enclosure width or depth, see page 991
- Punched section with mounting flange 23 x 64 mm **(B)** to match the enclosure height, see page 991

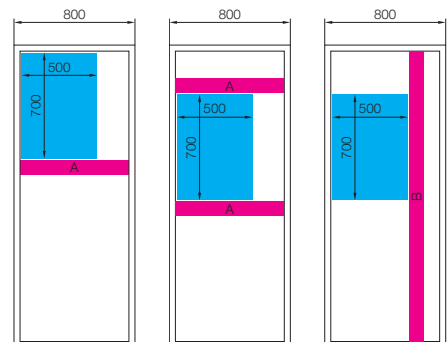

Door installation

Choose a partial mounting plate 100 mm smaller than the nominal size of the enclosure.
For example, a partial mounting plate with dimensions 500 x 700 mm can be installed on the tubular door frame of enclosures with a nominal size of 600 mm.

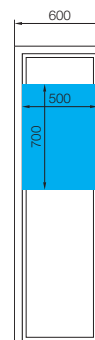

Interior installation

Mounting plates

Hinge attachment

for partial mounting plate VX

In conjunction with the mounting kit for swing frames, small, the partial mounting plate VX can be hinged to allow access to the components behind it for servicing.

Installation options:

- At the front, on the frame section
- Set back, in the enclosure depth
- At the side, in conjunction with the hinged side panel

Material:

- Steel

Surface finish:

- Zinc-plated

Supply includes:

- Assembly parts

Packs of	Model No.
1 pc(s).	8617.650

! Also required:

- Installation kit for swing frame, small, for enclosure width 600 mm (8619.600) or 800 mm (8619.610), see page 1076
- Punched section with mounting flange 23 x 64 mm according to the enclosure depth, see page 991

Examples

In the highest or lowest position

Front

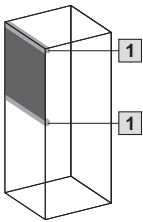

Set back

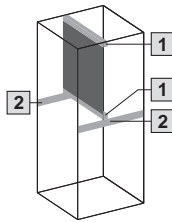

- 1 Installation kit for swing frame, small
- 2 Punched section with mounting flange 23 x 64 mm in accordance with the enclosure depth

In a central position

Front

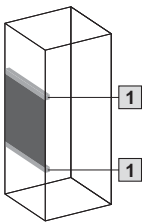

Set back

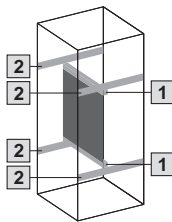

Interior installation

Mounting plates



Partial mounting plate holder for partial mounting plate VX

The partial mounting plate may be fitted set back by 20 mm behind the enclosure frame using the partial mounting plate holder, and also fastened directly to the frame from the outside. The partial mounting plate is also removable from the inside for servicing.

Material:

- Sheet steel

Surface finish:

- Zinc-plated, passivated

Supply includes:

- Assembly parts

Packs of	Model No.
4 pc(s).	8617.655

Partial mounting plate VX

Provides flexible and individual interior installation,
see page 980



Interior installation

Mounting plates

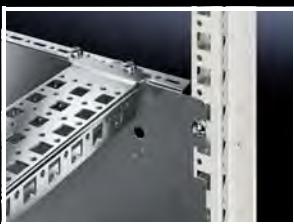

Partial mounting plate VX

for VX, VX SE

To accommodate additional components inside the enclosure. Partial mounting plates are extremely versatile, providing a platform for a diverse range of applications. They are attached directly to the enclosure section. For individual interior installation, system punchings are additionally provided in the edge fold.

Material:

- Sheet steel, 1.5 mm

Surface finish:

- Zinc-plated

Supply includes:

- Assembly parts

Dimensions mm	Packs of	Model No.
500 x 400	1 pc(s).	8617.660
500 x 600	1 pc(s).	8617.661
600 x 400	1 pc(s).	8617.662
600 x 600	1 pc(s).	8617.663
800 x 400	1 pc(s).	8617.664
800 x 600	1 pc(s).	8617.665



Also required:

- For the installation in VX SE: Adaptor rail VX, see page 995

Outer mounting level



Inner mounting level

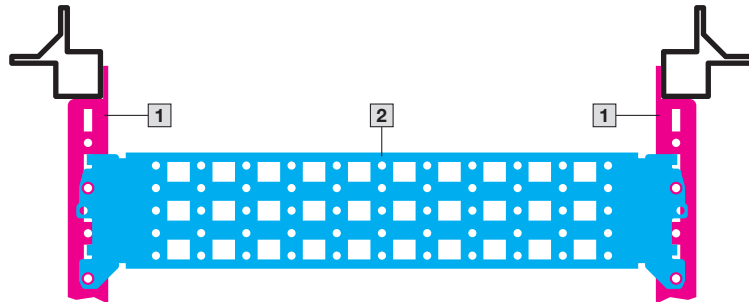

1 Partial assembly plate

2 Punched section with mounting flange, 23 x 64 mm

Interior installation

Mounting plates

Transport handle

for mounting plate,
for VX, VX SE

For use at any given position in the side C-fold.

Benefits include:

- Adapts to users of different heights
- Optimised force transmission
- Simple handling

Packs of	Model No.
2 pc(s).	2415.500



Mounting plate

for Outdoor Basic enclosure

For the configuration of mounting levels.

The mounting plates are depth-adjustable on a 25 mm pitch pattern.

Material:

- Aluminium, 3 mm

Supply includes:

- Assembly parts

Note:

- For an enclosure width of 1200 mm, partial installation with one or two 600 mm wide mounting plates is possible

For enclosure		F mm	G mm	Model No.
Width mm	Height mm			
600	1200	499	1096	9765.092
800	1200	699	1096	9765.095
1200	1200	1099	1096	9765.191

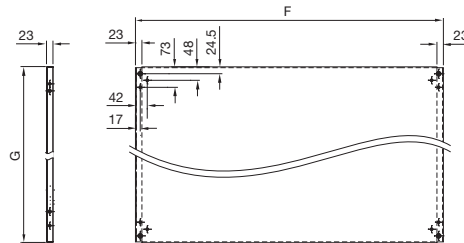

Mounting plate attachment

for TP one-piece console, TP pedestal
for high dynamic loads

To reduce vibrations in the mounting plate.

Applications:

- During transportation with heavy assemblies
- For dynamic applications, if a direct connection between the mounting plate and the enclosure is required for mobile use (e.g. with accompanying enclosures in crane systems, etc.)

Tested as per DIN EN 60 721

Severity 3 M4, with a weight of 150 kg evenly distributed over the mounting plate.

Simply screw-fasten to the existing holes in the mounting plate to pre-assemble for:

1 Wall mounting from the inside

Direct using a bracket and wall / support mounted enclosure.

2 Wall mounting from the outside

Screws for wall mounting brackets can easily be screwed into the square nut from the outside

Material:

- Sheet steel

Surface finish:

- Zinc-plated

Supply includes:

- Assembly parts

Packs of	Model No.
1 pc(s).	5001.075



Interior installation

Mounting plates



Partial mounting plate, locatable

for TP

For installation in

- Console and desk unit on the interior installation system rails
- Punched sections with mounting flanges or support strips fitted to the side of the pedestal in the depth

For easy mounting on pre-fitted assembly screws. Bayable by screw-fastening at the sides.

Material:

- Sheet steel

Surface finish:

- Zinc-plated

Supply includes:

- Assembly parts

Width mm	Height mm	Packs of	Model No.
200	437	1 pc(s).	6730.310
500	437	1 pc(s).	6730.330
700	437	1 pc(s).	6730.340

For console/desk unit width mm	Max. partial mounting plates that may be installed
600	1 x 6730.330
800	1 x 6730.340
1200	2 x 6730.310 1 x 6730.340
1600	1 x 6730.330 1 x 6730.340

1 From width 500 mm

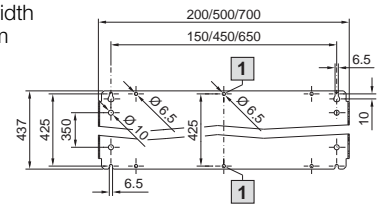

Interior installation

Rail systems

AX installation examples with system rails

Preparing for installation							
1) Rail for interior installation AX	Packs of	For enclosure depth mm					Page
		210	250	300	350	400	
Model No.	4 pc(s).	2393.210	2393.250	2393.300	2393.350	2393.400	989

Installation of support strip and punched section with mounting flange 14 x 39 mm in enclosure height/width							
For enclosure height/width mm	A ¹⁾ mm	2) Punched section with mounting flange, 14 x 39 mm		Page	3) Support strip		Page
		Packs of	Model No.		Packs of	Model No.	
400	275	4 pc(s).	8619.700	990	20 pc(s).	4594.000	994
500	375	4 pc(s).	8619.710		20 pc(s).	4309.000	
600	475	4 pc(s).	8619.720		20 pc(s).	4596.000	
700	575	4 pc(s).	8619.760		20 pc(s).	8800.130	
760	635	4 pc(s).	8619.790		20 pc(s).	–	
800	675	4 pc(s).	8619.730		20 pc(s).	4598.000	
1000	875	4 pc(s).	8619.750		20 pc(s).	4599.000	
1200	1075	4 pc(s).	8619.770		20 pc(s).	–	
1,400	1275	4 pc(s).	8619.780		20 pc(s).	–	

¹⁾ A = Rail mounting distance

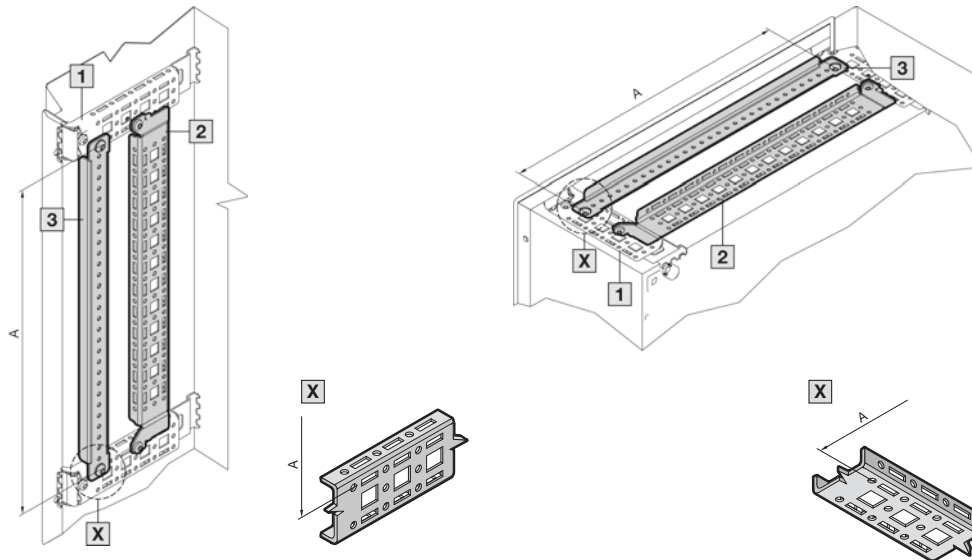

Installation of support strip and punched section with mounting flange 14 x 39 mm in enclosure width							
For enclosure width mm	A ¹⁾ mm	2) Punched section with mounting flange, 14 x 39 mm		Page	3) Support strip		Page
		Packs of	Model No.		Packs of	Model No.	
300	275	4 pc(s).	8619.700	990	20 pc(s).	4594.000	994
400	375	4 pc(s).	8619.710		20 pc(s).	4309.000	
500	475	4 pc(s).	8619.720		20 pc(s).	4596.000	
600	575	4 pc(s).	8619.760		20 pc(s).	8800.130	
700	675	4 pc(s).	8619.730		20 pc(s).	4598.000	
800	775	4 pc(s).	8619.740		20 pc(s).	4579.000	

¹⁾ A = Rail mounting distance

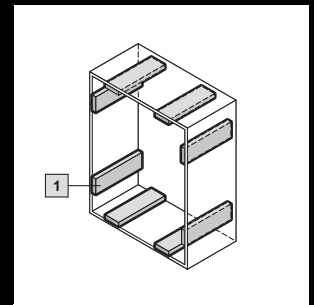
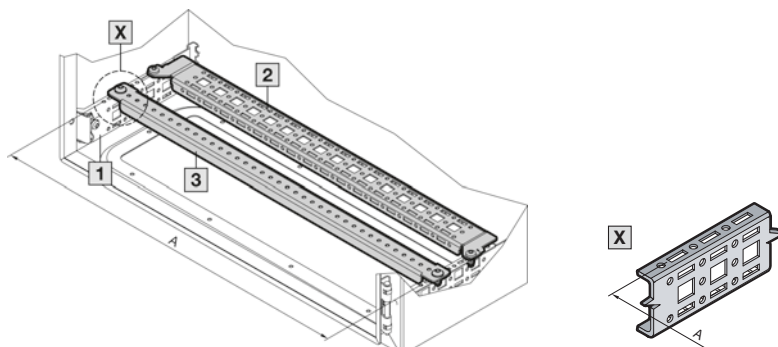

Interior installation

Rail systems

TP pedestal/one-piece console Installation examples with system rails

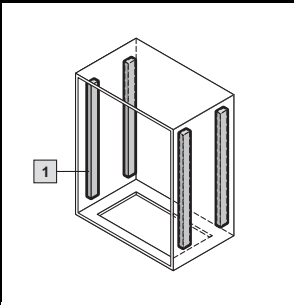

Preparing for installation					
1 Rail for interior installation	Packs of	For enclosure height mm			Page
		675	960		
Model No.	4 pc(s).	5001.050	5001.051	995	

Installation in the width							
For enclosure width mm	Packs of	Model No.					
A ¹⁾ mm		600	800	1000	1200	1600	
1 Punched section with mounting flange, 17 x 73 mm	4 pc(s).	8612.060	-	-	-	-	992
3 Support strip	20 pc(s).	8800.130	4579.000	-	-	-	994

Installation in the depth									
	For enclosure depth mm	A ¹⁾ mm	Packs of	Model No.					
4 Punched section with mounting flange 17 x 73 mm	400	325	4 pc(s).	8612.140	8612.140	8612.140	8612.140	8612.140	992
	500	425	4 pc(s).	8612.150	8612.150	8612.150	8612.150	8612.150	
5 Support strip	400	325	20 pc(s).	4694.000	4694.000	4694.000	4694.000	4694.000	994
	500	425	20 pc(s).	4695.000	4695.000	4695.000	4695.000	4695.000	

Installation in the height (individual installation e.g. with)	
Punched section with mounting flange, 17 x 73 mm	see page 992
Support strip	see page 994

¹⁾ A = Rail mounting distance

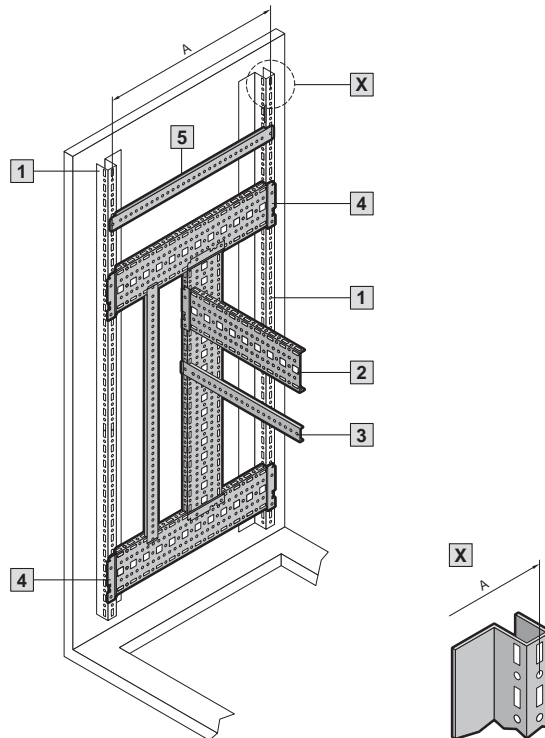

TP console Installation examples with system rails

Preparing for installation						
1 Rail for interior installation	Packs of	For enclosure width mm				Page
		600	800	1200	1600	
Model No.	4 pc(s).	5001.050	5001.051	5001.053	5001.054	995

Installation in the height							
	A ¹⁾ mm	Packs of	Model No.				
For enclosure width mm			600	800	1200	1600	
1 Punched section with mounting flange, 17 x 73 mm							
For cover	375	4 pc(s).	8612.040	8612.040	8612.040	8612.040	992
For enclosure	425	4 pc(s).	8612.150	8612.150	8612.150	8612.150	992
3 Support strip							
For cover	375	20 pc(s).	4309.000	4309.000	4309.000	4309.000	994
For enclosure	425	20 pc(s).	4695.000	4695.000	4695.000	4695.000	994
4 Punched section with mounting flange 14 x 39 mm							
For enclosure	375	4 pc(s).	8619.710	-	-	-	990

¹⁾ A = Rail mounting distance

Console/console lid

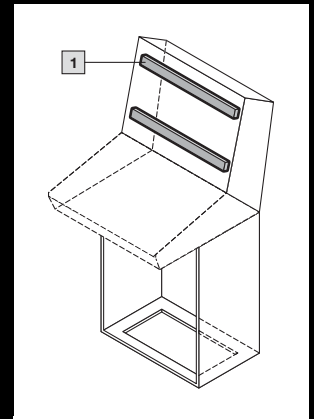
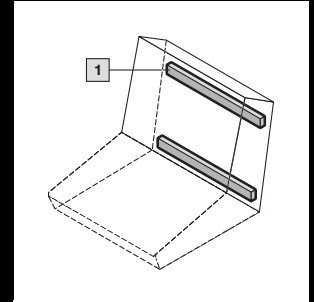
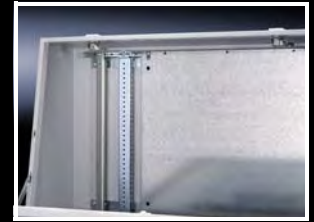
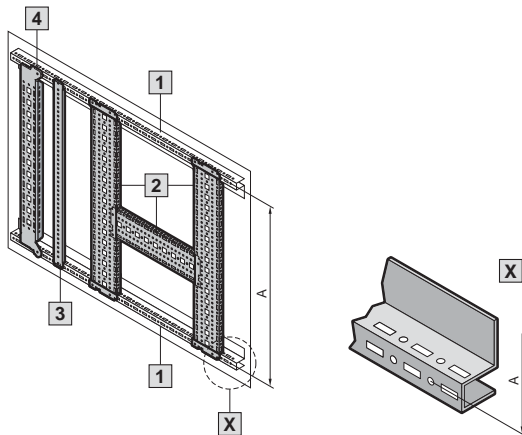

Interior installation

Rail systems

VX/ VX SE installation examples with system rails

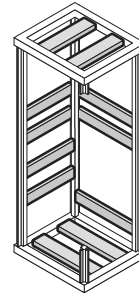

	Installation in the roof and base frame in the width/depth		Installation between vertical sections in the width/depth			
	VX	VX SE	Inner level		Outer level	
			VX	VX SE	VX	VX SE

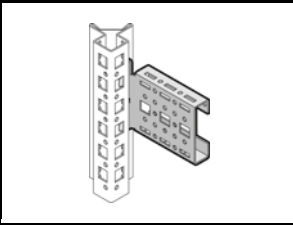

Punched section with mounting flange 18 x 64 mm, installation in VX							
For enclosure width/height/depth mm	Packs of	A ¹⁾ mm	Model No. ²⁾	Model No.	Model No. ²⁾	Model No.	Page
300	4 pc(s).	225	8617.000	-	-	8617.000	990
400	4 pc(s).	325	8617.010	-	-	8617.010	
500	4 pc(s).	425	8617.020	-	-	8617.020	
600	4 pc(s).	525	8617.030	-	-	8617.030	
800	4 pc(s).	725	8617.040	-	-	8617.040	
1000	4 pc(s).	925	8617.050	-	-	8617.050	
1200	4 pc(s).	1125	8617.060	-	-	8617.060	

¹⁾ A = Rail mounting distance

²⁾ Only suitable for installation in the roof

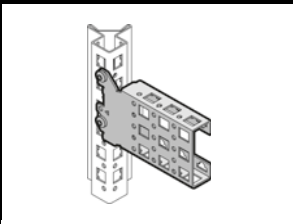

Punched section with mounting flange 23 x 64 mm, installation in VX, VX SE						
For enclosure width/height/depth mm	Packs of	A ¹⁾ mm	Model No. ²⁾	Model No. ²⁾	Model No.	Page
300	4 pc(s).	225	8617.100	8617.100	-	991
400	4 pc(s).	325	8617.110	8617.110	-	
500	4 pc(s).	425	8617.120	8617.120	-	
600	4 pc(s).	525	8617.130	8617.130	-	
800	4 pc(s).	725	8617.140	8617.140	-	
1000	4 pc(s).	925	8617.150	8617.150	-	
1200	4 pc(s).	1125	8617.160	8617.160	-	
1,400	4 pc(s).	1325	8617.170	8617.170	-	
1600	4 pc(s).	1525	8617.180	8617.180	-	
1800	4 pc(s).	1725	8617.190	8617.190	-	
2000	4 pc(s).	1925	8617.200	8617.200	-	
2200	4 pc(s).	2125	8617.210	8617.210	-	

¹⁾ A = Rail mounting distance

²⁾ For the installation on the vertical section of the VX SE, the adaptor rail VX is required, see page 995

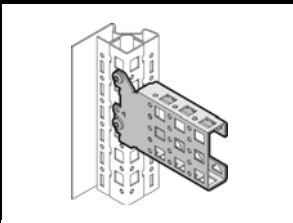

Interior installation

Rail systems

VX/VX SE installation examples with system rails

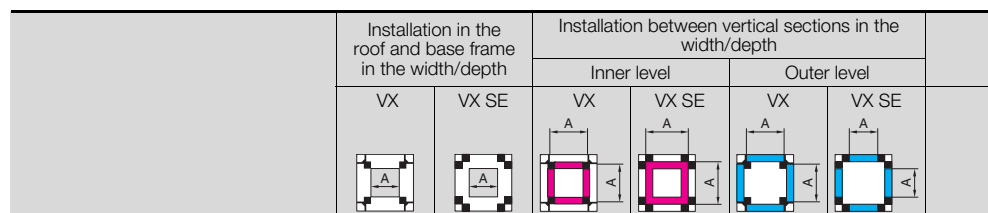

Punched section with mounting flange 23 x 89 mm, stainless steel, installation in VX, VX SE

For enclosure width/depth mm	Packs of	A ¹⁾ mm	Model No. ²⁾	Model No. ²⁾	Model No.	Page
400	2 pc(s).	325	8100.730	8100.730	–	991
500	2 pc(s).	425	8100.731	8100.731	–	
600	2 pc(s).	525	8100.732	8100.732	–	
800	2 pc(s).	725	8100.733	8100.733	–	

¹⁾ A = Rail mounting distance

²⁾ For the installation on the vertical section of the VX SE, the adaptor rail VX is required, see page 995

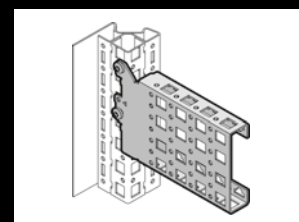
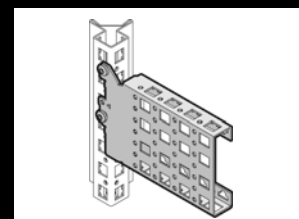

Punched section without mounting flange 23 x 64 mm, installation in VX, VX SE

For enclosure width/height/depth mm	Packs of	A ¹⁾ mm	Model No. ²⁾	Model No. ²⁾	Model No.	Page
400	2 pc(s).	325	8100.740	8100.740	–	993
500	2 pc(s).	425	8100.741	8100.741	–	
600	2 pc(s).	525	8100.742	8100.742	–	
800	2 pc(s).	725	8100.743	8100.743	–	
1200	2 pc(s).	1125	8100.745	8100.745	–	

¹⁾ A = Rail mounting distance

²⁾ For the installation on the vertical section of the VX SE, the adaptor rail VX is required, see page 995

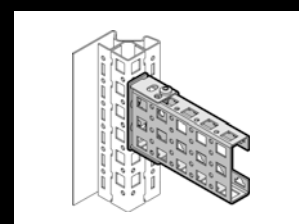
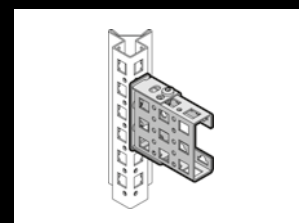

Interior installation

Rail systems

VX/VX SE installation examples with system rails

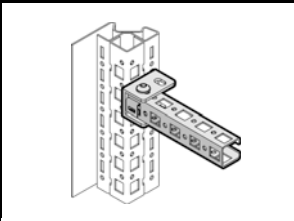
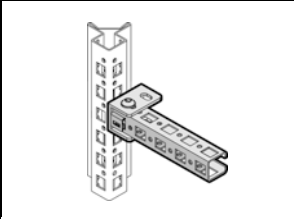
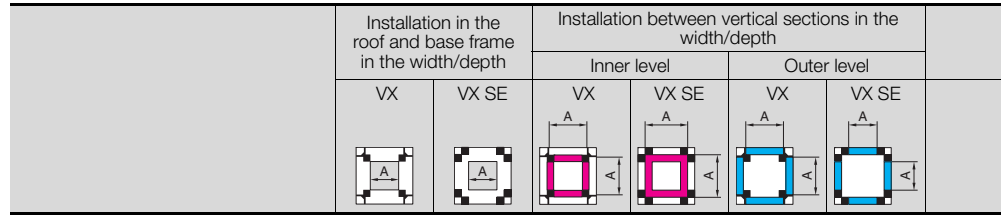

Punched rail 23 x 23 mm, installation in VX, VX SE

For enclosure width/height/depth mm	Packs of	A ¹⁾ mm	Model No. ^{2) 3)}	Model No. ^{2) 3)}	Model No.	Page
400	12 pc(s).	325	4169.000	4169.000	-	994
500	12 pc(s).	425	4170.000	4170.000	-	
600	12 pc(s).	525	4171.000	4171.000	-	
800	12 pc(s).	725	4172.000	4172.000	-	
1000	12 pc(s).	925	4173.000	4173.000	-	
1200	6 pc(s).	1125	4174.000	4174.000	-	
1400	6 pc(s).	1325	4393.000	4393.000	-	
1600	6 pc(s).	1525	4175.000	4175.000	-	
1800	6 pc(s).	1725	4176.000	4176.000	-	
2000	6 pc(s).	1925	4177.000	4177.000	-	
2200	6 pc(s).	2125	4178.000	4178.000	-	

¹⁾ A = Rail mounting distance

²⁾ For the installation on the vertical section of the VX SE, the adaptor rail VX is required, see page 995

³⁾ For the installation in VX and VX SE, the mounting bracket 4182.000 and a U nut are required, see page 1002/1003

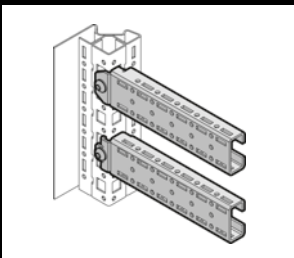
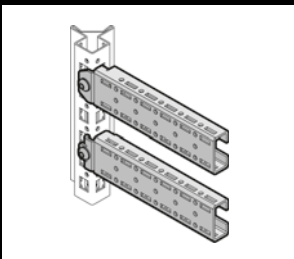

Punched rail 18 x 39 mm, installation in VX, VX SE

For enclosure width/depth mm	Packs of	A ¹⁾ mm	Model No. ²⁾	Model No. ²⁾	Model No.	Page
400	4 pc(s).	325	8617.700	8617.700	-	993
500	4 pc(s).	425	8617.710	8617.710	-	
600	4 pc(s).	525	8617.720	8617.720	-	
800	4 pc(s).	725	8617.730	8617.730	-	

¹⁾ A = Rail mounting distance

²⁾ For the installation on the vertical section of the VX SE, the adaptor rail VX is required, see page 995

Interior installation

Rail systems

Rail for interior installation AX

For mounting in the enclosure, no machining required. Suitable for mounting on the side, base and roof using the locators integrated into the enclosure.

Variable with 2 rows of system punchings, creates additional mounting space e.g. for:

- Punched section with mounting flange, 14 x 39 mm
- Enclosure lights
- Door-operated switch
- Door stay
- Cable conduit holder

Benefits:

- Only one screw for attaching the rail inside the enclosure
- Including adaptor for door-operated switch
- Compatibility with VX25 accessories
- Enclosure protection category is retained (no machining required)
- Automatic potential equalisation
- May be retro-fitted even with the mounting plate in situ, suitable for installation via gland plates

Material:

- Sheet steel

Surface finish:

- Zinc-plated



Also required:

- For installing LED system light: Mounting bracket for interior installation, see page 1000

For enclosure depth mm	Packs of	Model No.
210	4 pc(s).	2393.210
250	4 pc(s).	2393.250
300	4 pc(s).	2393.300
350	4 pc(s).	2393.350
400	4 pc(s).	2393.400

Configuration examples:

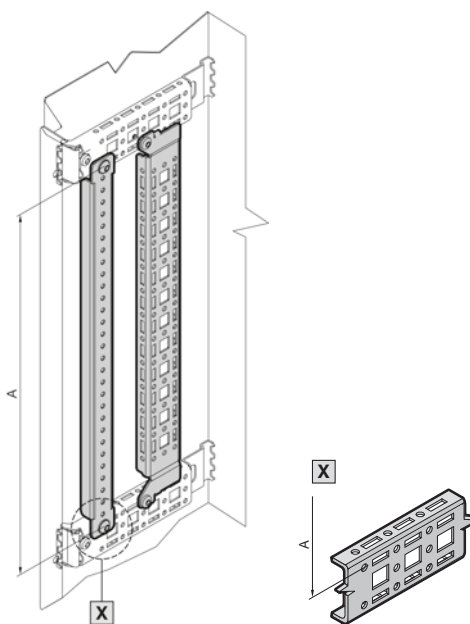

A = Rail mounting distance

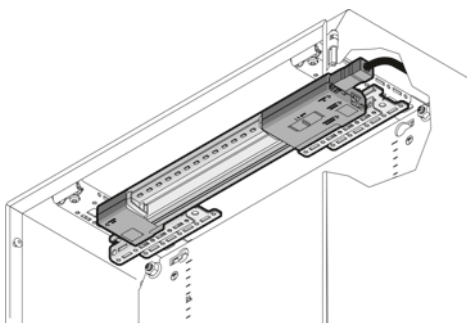

Mounting of LED system light



Interior installation

Rail systems



Punched section with mounting flange, 14 x 39 mm

for AX

Interior installation in the enclosure height and width
Locates securely onto the interior installation rail AX.

For the attachment of

- Cable ducts
- Cable conduit holder

Material:

- Sheet steel

Surface finish:

- Zinc-plated

Supply includes:

- Assembly parts

For enclosure height/width mm	Distance between attachment points mm	Packs of	Model No.
400	275	4 pc(s).	8619.700
500	375	4 pc(s).	8619.710
600	475	4 pc(s).	8619.720
700	575	4 pc(s).	8619.760
760	635	4 pc(s).	8619.790
800	675	4 pc(s).	8619.730
1000	875	4 pc(s).	8619.750
1200	1075	4 pc(s).	8619.770
1400	1275	4 pc(s).	8619.780



Also required:

- Interior installation rail AX for configuration in the enclosure height and width, see page 989



Accessories:

- Screws and self-tapping screws M5 for configuring the customer's own components on the punched section with mounting flange, see page 1004



Punched section with mounting flange, 18 x 64 mm

for VX

For variable, individual interior installation of the enclosure frame on the outer mounting level. Simply locate into the system punchings from the outside and screw-fasten. System punchings on all four sides. With bayed enclosures, the punched sections with mounting flanges may also be fitted from the inside of the enclosure.

Installation options:

- On the outer mounting level, on the enclosure section
- On the outer mounting level, between two punched sections with mounting flanges 23 x 64 mm

Material:

- Sheet steel

Surface finish:

- Zinc-plated

Supply includes:

- Assembly parts

For enclosure width/height/depth mm	Packs of	Model No.
300	4 pc(s).	8617.000
400	4 pc(s).	8617.010
500	4 pc(s).	8617.020
600	4 pc(s).	8617.030
800	4 pc(s).	8617.040
1000	4 pc(s).	8617.050
1200	4 pc(s).	8617.060



Accessories:

- Screws, see page 1004
- Cable tie 2597.000, see page 1061

Punched section with mounting flange, 23 x 64 mm

for VX, VX IT, VX SE, AX plastic

For variable and individual interior installation. Simply locate into punchings and screw-fasten. System punchings on all four sides. With slots at the top and bottom for cage nuts, for attaching your own components via metric screws.

Installation options:

VX/VX IT

- On the inner mounting level, on the enclosure section VX

VX SE

- On the vertical section of the VX SE with adaptor rail VX

AX plastic

- In the width and height of the enclosure in conjunction with universal bracket

System accessories

- On identical punched sections with mounting flanges
- In the base/plinth system VX in the width and depth, combined with a base/plinth installation bracket

Material:

- Sheet steel

Surface finish:

- Zinc-plated

Supply includes:

- Assembly parts

For enclosure width/height/depth mm	Packs of	Model No.
300	4 pc(s).	8617.100
400	4 pc(s).	8617.110
500	4 pc(s).	8617.120
600	4 pc(s).	8617.130
800	4 pc(s).	8617.140
1000	4 pc(s).	8617.150
1200	4 pc(s).	8617.160
1400	4 pc(s).	8617.170
1600	4 pc(s).	8617.180
1800	4 pc(s).	8617.190
2000	4 pc(s).	8617.200
2200	4 pc(s).	8617.210



Also required:

- For VX SE: Adaptor rail VX, see page 995
- For AX plastic: Universal bracket 1485.200, see page 97



Accessories:

- Screws, see page 1004
- Cable tie 2597.000, see page 1061
- Cage nut, see page 1002
- Base/plinth installation bracket, see page 885

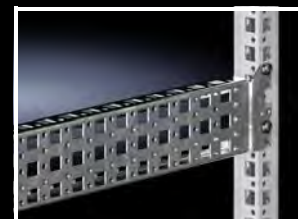

Punched section with mounting flange, 23 x 89 mm

Stainless steel for VX, VX SE

For variable, individual interior installation of the enclosure frame on the inner mounting level. Simply locate into punchings and screw-fasten. System punchings on all four sides. With slots at the top and bottom for cage nuts, for attaching your own components via metric screws. Especially for cable routing in the base/plinth system VX, stainless steel and for the installation of busbar supports (non-magnetic stainless steel).

Installation options:

VX

- On the inner mounting level, on the enclosure section VX

VX SE

- On the vertical section of the VX SE with adaptor rail VX

System accessories

- On identical punched sections with mounting flanges
- In the base/plinth system VX, stainless steel, in the width and depth, combined with a base/plinth installation bracket

Material:

- Stainless steel

Supply includes:

- Assembly parts

For enclosure width/depth mm	Packs of	Model No.
400	2 pc(s).	8100.730
500	2 pc(s).	8100.731
600	2 pc(s).	8100.732
800	2 pc(s).	8100.733



Also required:

- For VX SE: Adaptor rail VX, see page 995



Accessories:

- Screws, see page 1004
- Cable tie 2597.000, see page 1061
- Cage nut, see page 1002
- Base/plinth installation bracket, see page 885



Interior installation

Rail systems

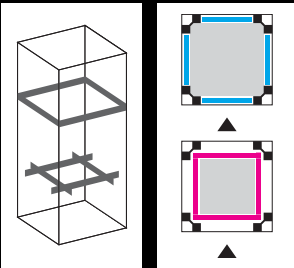
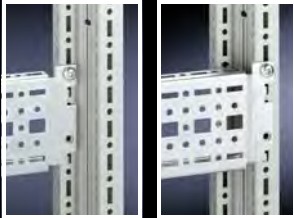

Punched section with mounting flange, 17 x 73 mm

for VX SE, TP, PC, IW

For universal skeleton structures or partial assembly. Simply locate onto the punchings and secure.

Installation options:

VX SE, PC, IW

- On the vertical enclosure section
 - On the outer mounting level, all-round, at the same height
 - On the inner mounting level, all-round, height-offset

VX SE, PC

- On the horizontal enclosure extrusion
 - May be mounted on the top horizontal section in the depth

TP

- Via rail for interior installation
 - In the depth, for outer mounting level
 - In the width, for inner mounting level

Material:

- Sheet steel

Surface finish:

- Zinc-plated

Supply includes:

- Assembly screws



Also required:

- For installation in TP: Rail for interior installation, see page 995



Accessories:

- Screws, see page 1004
- Cable tie for fast assembly 2597.000, see page 1061.

For the outer mounting level

For enclosure width/depth mm	Packs of	Model No.
300	4 pc(s).	8612.130
400	4 pc(s).	8612.140
500	4 pc(s).	8612.150
600	4 pc(s).	8612.160

For the inner mounting level

For enclosure width/depth mm	Length mm	Packs of	Model No.
300	290	4 pc(s).	8612.030
400	390	4 pc(s).	8612.040
500	490	4 pc(s).	8612.050
600	590	4 pc(s).	8612.060

Interior installation

Rail systems

Punched section without mounting flanges, 23 x 64 mm

for VX, VX SE

For variable, individual interior installation of the enclosure frame on the inner mounting level. Mounted flush with enclosure frame. The additional mounting brackets mean it can also be used with a pre-installed mounting plate, and is also prepared for cutting to any required length. System punchings on all four sides. With slots at the top and bottom for cage nuts, for attaching your own components via metric screws.

Installation options:

VX
– On the inner mounting level, on the enclosure section

VX SE
– On the vertical section of the VX SE with adaptor rail VX

System accessories

– Between two punched sections with mounting flanges for the inner mounting level
– As installation kit for component shelves

Material:

– Sheet steel

Surface finish:

– Zinc-plated

Supply includes:

– 1 pack =
2 punched sections without mounting flanges 23 x 64 mm
4 mounting brackets

For enclosure width/height/depth mm	Packs of	Model No.
400	2 pc(s).	8100.740
500	2 pc(s).	8100.741
600	2 pc(s).	8100.742
800	2 pc(s).	8100.743
1200	2 pc(s).	8100.745



Also required:

– For VX SE: Adaptor rail VX, see page 995

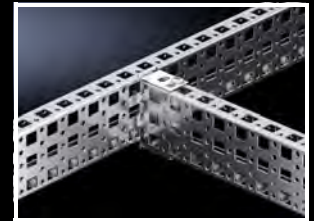
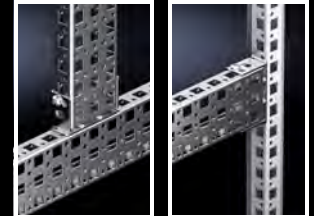

Punched rail 18 x 39 mm

for VX, VX SE

For variable, individual interior installation of the enclosure frame on the inner mounting level, may also be used in conjunction with other punched sections. Prepared at the rear to accommodate cable clamps for optimum cable routing inside the enclosure.

Installation options:

VX
– On the inner mounting level, on the enclosure section

VX SE
– On the vertical section of the VX SE with adaptor rail VX

Material:

– Sheet steel

Surface finish:

– Zinc-plated

Supply includes:

– Assembly parts

For enclosure width/depth mm	Packs of	Model No.
400	4 pc(s).	8617.700
500	4 pc(s).	8617.710
600	4 pc(s).	8617.720
800	4 pc(s).	8617.730

Note:

– In enclosures with a mounting plate, two punched rails (as mounting plate slide rails) are already included with the supply



Also required:

– For VX SE: Adaptor rail VX, see page 995



Accessories:

– Screws, see page 1004
– Cable tie 2597.000, see page 1061
– Cable clamps, see page 1060

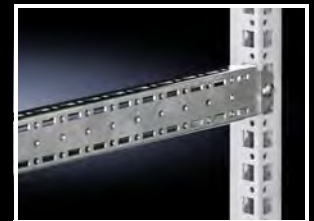

Interior installation

Rail systems



Punched rail 23 x 23 mm for VX, VX SE

Installation options:

VX

- To the vertical and horizontal enclosure sections via mounting brackets

VX SE

- To the vertical enclosure section via mounting brackets in conjunction with adaptor rail VX
- To the horizontal section/in roof via mounting brackets in conjunction with adaptor rail VX in the depth

Material:

- Sheet steel

Surface finish:

- Zinc-plated

Length mm	For WHD mm	Packs of	Model No.
295	400	12 pc(s).	4169.000
395	500	12 pc(s).	4170.000
495	600	12 pc(s).	4171.000
695	800	12 pc(s).	4172.000
895	1000	12 pc(s).	4173.000
1095	1200	6 pc(s).	4174.000
1295	1400	6 pc(s).	4393.000
1495	1600	6 pc(s).	4175.000
1695	1800	6 pc(s).	4176.000
1895	2000	6 pc(s).	4177.000
2095	2200	6 pc(s).	4178.000



Also required:

- For VX SE: Adaptor rail VX, see page 995
- U nuts, see page 1003
- Mounting bracket 4182.000, see page 1002



Accessories:

- Cable attachment, see page 1061
- Screws, see page 1004
- Cable tie for fast assembly 2597.000, see page 1061



Support strip

for VX, VX SE

For simple cable routing from the mounting plate to the door.

Installation options:

- On the inner and outer mounting level, on the enclosure section

Material:

- Sheet steel

Surface finish:

- Zinc-plated

Supply includes:

- Assembly parts

Note:

- Installation options for TP interior installation, see page 984/985
- VX, VX SE, AX, TP, PC, IW door installation, see page 952



Accessories:

- Screws, see page 1004
- Cable tie 2597.000, see page 1061

For enclosure width/depth mm	For enclosure system, inner level	For enclosure system, outer level	Rail mounting distance mm	Packs of	Model No.
400	VX	VX, VX SE	325	20 pc(s).	4694.000
	VX SE	-	375	20 pc(s).	4309.000
500	VX	VX, VX SE	425	20 pc(s).	4695.000
	VX SE	-	475	20 pc(s).	4596.000
600	VX	VX, VX SE	525	20 pc(s).	4696.000
	VX SE	-	575	20 pc(s).	8800.130
800	VX	VX, VX SE	725	20 pc(s).	4697.000
	VX SE	-	775	20 pc(s).	4579.000

Interior installation

Rail systems

Adaptor rail VX

for VX compatibility for VX SE

To create compatibility of the interior installation between VX SE and VX25. The adaptor rail VX can be cut to length for customised configurations.

Installation options:

- On the vertical enclosure section of the VX SE (over the full installation height or in sub-sections)
- On the horizontal roof section of the VX SE, in the width

Supply includes:

- 4 adaptor rails
- Assembly parts

For enclosure height mm	Length mm	Packs of	Model No.
-	200	4 pc(s).	8617.760
1800	-	4 pc(s).	8617.750
2000	-	4 pc(s).	8617.751

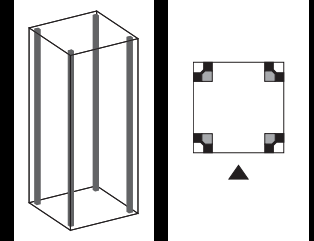
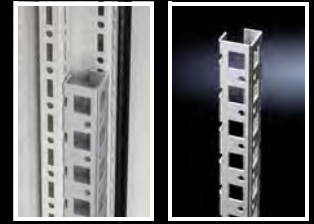

Rail for interior installation

for TP, compact enclosures HD

For mounting on the existing threaded bolts. With system punchings on three sides.

Material:

- Sheet steel

Surface finish:

- Zinc-plated

Supply includes:

- Assembly parts

For enclosure width mm	For enclosure height mm	For enclosure height mm	Packs of	Model No.
TP ¹⁾	TP ²⁾	HD		
600	675	650	4 pc(s).	5001.050
800	960	-	4 pc(s).	5001.051
1000	-	1050	4 pc(s).	5001.052
1200	-	1250	4 pc(s).	5001.053
1600	-	-	4 pc(s).	5001.054

- ¹⁾ Only with TP console and desk unit (cover or rear panel/base), one-piece console in cover
²⁾ Only with TP pedestal/one-piece console

Note:

- Installation options TP, see page 984/985
- Installation options HD, see page 225



Base configuration rail

for TP

For mounting in the enclosure depth, on the existing threaded bolts, no machining required. System punchings on 2 sides. Creates additional installation options.

Material:

- Sheet steel

Surface finish:

- Zinc-plated

Supply includes:

- Assembly parts

For enclosure depth mm	Packs of	Model No.
400	2 pc(s).	5001.370

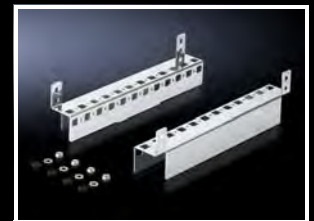

Interior installation

Rail systems



C rail 30/15 to EN 60 715, for VX, VX SE

Installation options:

- On the inner mounting level, on the enclosure section
- In the base/plinth VX

Material:

- Sheet steel

Surface finish:

- Zinc-plated

For enclosure width/depth mm	Length mm	Packs of	Model No.
500	455	6 pc(s).	4943.000
600	555	6 pc(s).	4944.000
800	755	6 pc(s).	4945.000
1000	955	6 pc(s).	4946.000
1200	1155	6 pc(s).	4947.000

+ Accessories:

- Cable clamps, see page 1060
- Support bracket or spacer, see page 1001
- Quick-assembly block, see page 1001

⇒ Possible alternative:

- Rail for EMC shielding bracket and strain relief, see page 1029

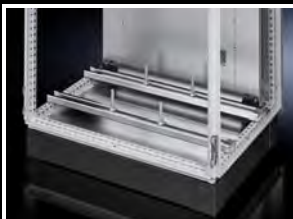

Support rail 48 x 26 mm

for VX, VX SE

For heavy installed equipment such as transformers. T-head screw and slots in the support rail accommodate all mounting dimensions.

Installation options:

- VX
- On the inner mounting level, on the enclosure section

VX SE

- On the inner mounting level, on the enclosure section in conjunction with adaptor rail VX

Material:

- Sheet steel

Surface finish:

- Zinc-plated

Supply includes:

- Assembly parts

For enclosure width mm	Packs of	Model No.
600	2 pc(s).	8617.800
800	2 pc(s).	8617.810
1000	2 pc(s).	8617.820
1200	2 pc(s).	8617.830

! Also required:

- For VX SE: Adaptor rail VX, see page 995

+ Accessories:

- Punched section with mounting flange 23 x 64 mm for height-offset installation, see page 991



Support rail 75 x 20 mm

for VX, VX SE

For heavy installed equipment such as base isolators or transformers.

Installation options:

- VX
- On the inner mounting level, on the enclosure section

VX SE

- On the inner mounting level, on the enclosure section in conjunction with adaptor rail VX

Material:

- Sheet steel

Surface finish:

- Zinc-plated

Supply includes:

- Assembly parts

For enclosure width/depth mm	Packs of	Model No.	Model No.
		Slotted	Unslotted
400	4 pc(s).	4394.000	–
500	4 pc(s).	4395.000	–
600	4 pc(s).	4396.000	4396.500
800	4 pc(s).	4398.000	4398.500

! Also required:

- For VX SE: Adaptor rail VX, see page 995

Interior installation

Rail systems

Support rail 65 x 42 mm

for VX, VX SE

For heavy installed equipment such as base isolators or transformers.

Installation options:

VX

- On the inner mounting level, on the enclosure section

VX SE

- On the inner mounting level, on the enclosure section in conjunction with adaptor rail VX

Material:

- Steel

Surface finish:

- Zinc-plated

Supply includes:

- Assembly parts

For enclosure width mm	Packs of	Model No.
600	2 pc(s).	8612.960
800	2 pc(s).	8612.980



Also required:

- For VX SE: Adaptor rail VX, see page 995

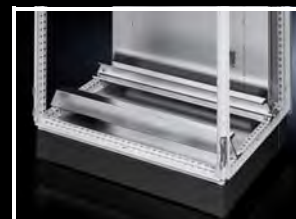

Support rails TS 35/15

to EN 60 715

for VX, VX SE

Mounting on the vertical section via

- threaded block M8, 4163.000, see page 1003

For enclosure width/depth mm	Support rail length mm	Packs of	Model No.
500	455	6 pc(s).	4933.000
600	555	6 pc(s).	4934.000
800	755	6 pc(s).	4935.000
1200	1155	6 pc(s).	4937.000
–	2000	6 pc(s).	2313.150



Support rails TS 35/7.5 and TS 35/15

to EN 60 715

for KX, AX, terminal box HD

For enclosure width mm	Support rail length mm	Version	Packs of	Model No.
150	137	TS 35/7.5	10 pc(s).	2314.000
200	187		10 pc(s).	2315.000
300	287		10 pc(s).	2316.000
400	387		10 pc(s).	2317.000
–	2000	TS 35/15	6 pc(s).	2313.750
500	487		10 pc(s).	2318.000
600	587		10 pc(s).	2319.000



Mounting clip

For fast, secure attachment of:

- Cable ducts
- Mounting plates
- Mounting angles

on support rail TS 35/7.5 and 35/15 to EN 60 715.

Simply pre-assemble the mounting clip on the part to be installed, then snap into position on the support rail.

Packs of	Model No.
30 pc(s).	2309.000



Interior installation

Rail systems

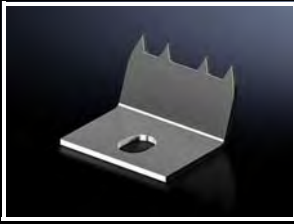

Mounting claw for second mounting level

for terminal boxes KX, bus enclosures KX

For fixing top hat rails directly onto the rear panel of KX terminal boxes and KX bus enclosures. Creates an additional mounting level with an extra 10 mm of installation depth without having to machine the enclosure.

Packs of	Model No.
20 pc(s).	2309.100

Accessories:

- Support rails TS 35/7.5 to EN 60 715, see page 997

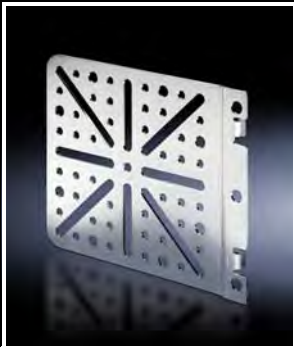

Mounting plate

Locatable for AX, VX, VX SE

Installation options:

- On the inner and outer mounting level, on the enclosure section
- On punched sections with mounting flanges
- On rail for interior installation AX
- On the perforated door strip AX

Material:

- Sheet steel

Surface finish:

- Zinc-plated

Supply includes:

- Assembly screws

Packs of	Model No.
4 pc(s).	8612.400

Accessories:

- Screws, see page 1004
- Cable tie 2597.000, see page 1061

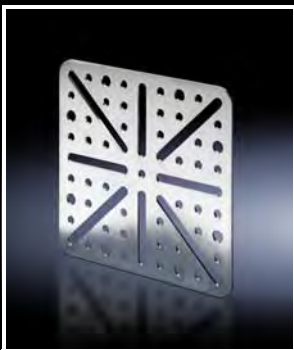

Mounting plate

Screw-fastened, large for AX, VX, VX SE, AX plastic

Installation options:

- On all enclosures and mounting parts with system punchings on a 25 mm pitch pattern
- On the perforated door strip AX

Material:

- Sheet steel

Surface finish:

- Zinc-plated

Supply includes:

- Assembly screws

Packs of	Model No.
4 pc(s).	8612.410

Accessories:

- Screws, see page 1004
- Cable tie 2597.000, see page 1061

Mounting plate

Screw-fastened, small for AX, VX, VX SE, AX plastic

Installation options:

- On all enclosures and mounting parts with system punchings on a 25 mm pitch pattern
- On the perforated door strip AX

Material:

- Sheet steel

Surface finish:

- Zinc-plated

Supply includes:

- Assembly screws

Packs of	Model No.
4 pc(s).	4532.000



Accessories:

- Screws, see page 1004
- Cable tie 2597.000, see page 1061



Mounting plate

with integral top hat rail for AX, VX, VX SE, AX IT, VX IT, TE

For direct snap-mounting of components such as speed control, enclosure internal thermostat and hygrostat.

Material:

- Sheet steel

Surface finish:

- Zinc-plated

Supply includes:

- Assembly parts

Packs of	Model No.
1 pc(s).	7526.964

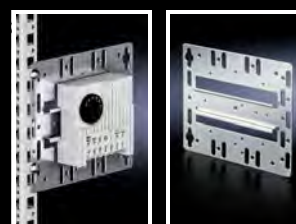

Mounting bracket

Installation options:

- On all enclosures and mounting parts with system punchings on a 25 mm pitch pattern

Material:

- Sheet steel

Surface finish:

- Zinc-plated

Supply includes:

- Assembly screws

Packs of	Model No.
4 pc(s).	4597.000



Accessories:

- Screws, see page 1004
- Cable tie 2597.000, see page 1061



Interior installation

Rail systems

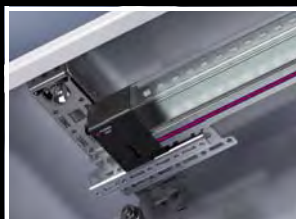

Mounting bracket

for interior installation

For installing punched sections with mounting flanges and support strips in

- Comfort Panel horizontal/vertical from 74 mm installation depth

or for installing in:

- Optipanel from an installation depth of 100 mm

For installing the LED system light in

- compact enclosures AX in conjunction with the rail for interior installation AX, see page 989, without machining and without the use of tools

Material:

- Sheet steel

Surface finish:

- Zinc-plated

Supply includes:

- Assembly parts

Packs of	Model No.
4 pc(s).	6205.100

Mounting options in Comfort Panel/Optipanel

		Front panel width 482.6 mm (19")	Page
Punched section with mounting flange	Horizontal	8612.150	992
	Vertical		
Support strips	Horizontal	4695.000	994
	Vertical		

Interior installation

Assembly components

Bracket/spacer

For flexible attachment of C rails, punched rails or cable clamp rails (angle piece). On the sides, to accommodate square sections or tubes (\varnothing 20 mm). Attachment points with M8 thread.

Installation options:

- On vertical and horizontal VX, VX SE enclosure section
- On punched sections with mounting flanges for the inner mounting level
- On enclosures and rails with rectangular system punching 12.5 x 11 mm

Material:

- Die-cast zinc

Supply includes:

- 1 pc(s). =
 - 1 bracket/spacer
 - 2 screws M8 x 16 mm
 - 2 spring lock washers
 - 2 cage nuts M8
 - 2 screws

Packs of	Model No.
6 pc(s).	4199.000



Also required:

- For VX SE: Adaptor rail VX, see page 995



Accessories:

- Angle piece 4134.000, see page 1001

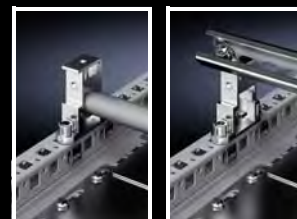
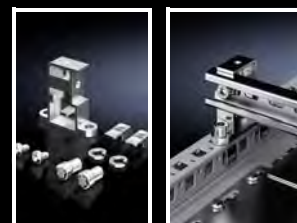

Quick-assembly block

for a variety of installation options.

Installation options:

- On vertical and horizontal VX, VX SE enclosure section
- On punched sections with mounting flanges for the inner mounting level
- On enclosures and rails with rectangular system punching 12.5 x 11 mm

Material:

- Die-cast zinc

Supply includes:

- 12 quick-assembly blocks
- 12 threaded blocks M8
- 24 screws M8 x 12 mm
- 24 square nuts M8

Packs of	Model No.
12 pc(s).	4133.000



Also required:

- For VX SE: Adaptor rail VX, see page 995



Accessories:

- Angle piece 4134.000, see page 1001



Angle piece

For assembling mounting surfaces with a 45° incline. Optimum positioning of cable clamp rails, etc.

With two mounting options as standard:

- Conductively connected to the subsurface
- Insulated from the mounting surface

Installation options:

- On vertical and horizontal VX, VX SE enclosure section
- On punched sections with mounting flanges for the inner mounting level
- On the bracket/spacer
- On the quick-assembly block
- On enclosures and rails with rectangular system punching 12.5 x 11 mm

Material:

- Angle pieces: Die-cast zinc
- Insulating pieces: Plastic

Supply includes:

- 1 pc(s). =
 - 1 angle piece
 - 1 insulating piece
 - 1 insulating screw
 - 2 assembly screws
 - 1 threaded block M8

Packs of	Model No.
12 pc(s).	4134.000



Also required:

- For VX SE: Adaptor rail VX, see page 995

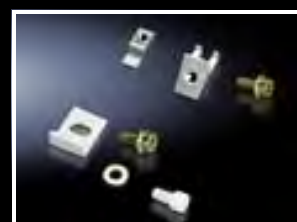

Interior installation

Assembly components

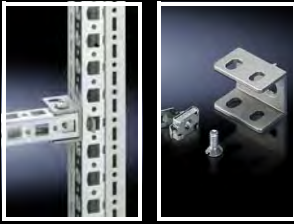

Mounting bracket

for VX, VX SE

For variable attachment of punched rail 23 x 23 mm.

Installation options:

- Optionally flush with the outer edge of the enclosure or the enclosure clearance width
- On the vertical VX, VX SE enclosure section
- On the horizontal VX enclosure section
- On the horizontal VX SE enclosure section, bottom
- On the horizontal VX SE enclosure section, top in the width and depth
- On enclosures and rails with rectangular system punching 12.5 x 11 mm

Material:

- Die-cast zinc

Supply includes:

- 1 pc(s). =
- 1 mounting bracket
- 1 screw M6 x 12 mm,
- 1 cage nut M6

Packs of	Model No.
24 pc(s).	4182.000



Also required:

- U nut (recommended: M6), see page 1003
- Multi-tooth screws M6 x 12 mm, see page 1004
- For VX SE: Adaptor rail VX, see page 995



Rail mounting bracket

For individual mounting of rails at a distance from the mounting surface.

Material:

- Sheet steel, zinc-plated

Rail mounting bracket	Packs of	Model No.
Flat	20 pc(s).	2365.000
Inclined	20 pc(s).	2366.000

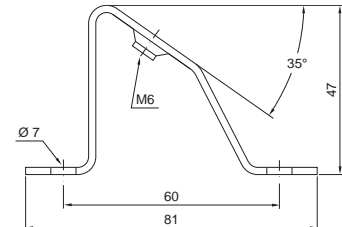
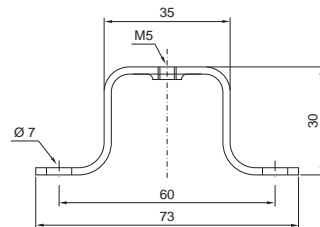

Cage nut

For all-round metric mounting on the enclosure section.

Benefits:

- For all-round mounting on the enclosure section
- The compression spring, designed as an insertion aid, ensures reliable mechanical and electrical connection in the system punchings.
- Simply slides in from the side
- Safely and easily released with a screwdriver

Installation options:

- On vertical and horizontal VX, VX SE enclosure section
- On punched sections with mounting flanges, 23 x 64 mm
- On punched sections with mounting flanges, 23 x 89 mm, stainless steel
- On punched rails 23 x 23 mm
- On punched section without mounting flanges, 23 x 64 mm
- On enclosures and rails with rectangular system punching 12.5 x 11 mm

Thread	Packs of	Model No.
M5	20 pc(s).	4166.500
M6	20 pc(s).	4164.500
M8	20 pc(s).	4165.500



Also required:

- For VX SE: Adaptor rail VX, see page 995



Interior installation

Assembly components

U nut

for punched rail 23 x 23 mm

For mounting punched rails and punched sections without mounting flanges on mounting brackets, we recommend U nuts with M6 thread 4179.000.

Thread	Packs of	Model No.
M4	20 pc(s).	4119.000
M5	20 pc(s).	4157.000
M6	20 pc(s).	4179.000
M8	20 pc(s).	4180.000



Accessories:

- Multi-tooth screws M6 x 12 mm, for 4179.000, see page 1004

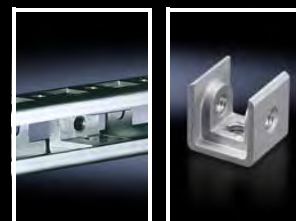

Threaded block

For all-round metric mounting in the enclosure section. With snap-off insertion aid, made from die-cast zinc.

Installation options:

- On vertical and horizontal VX, VX SE enclosure section
- On punched sections with mounting flanges, 23 x 64 mm
- On punched sections with mounting flanges, 23 x 89 mm, stainless steel
- On punched rails 23 x 23 mm
- On punched section without mounting flanges, 23 x 64 mm
- On enclosures and rails with rectangular system punching 12.5 x 11 mm

Thread	Packs of	Model No.
M6	50 pc(s).	4162.000
M8	50 pc(s).	4163.000



Also required:

- For VX SE: Adaptor rail VX, see page 995



Spring nut M5

For

- Comfort Panel from an installation depth of 74 mm
- Optipanel from an installation depth of 100 mm
- Compact Panel

The spring ensures reliable protection against unintentional displacement.

Other interior installation, e.g. with

- Mounting bracket 4597.000, see page 999 or
- mounting bracket components for interior installation 6205.100, see page 1000

Material:

- Steel, zinc-plated

Packs of	Model No.
50 pc(s).	6108.000



Interior installation

Assembly components



Universal bracket

- For the installation of
- Enclosure lights in
 - Compact enclosures AX
 - Door-operated switches in
 - Compact enclosures AX
 - TopConsole system TP
 - Cable conduit holders 2593.000 and 2591.000 in
 - Compact enclosures AX
 - Support rails for terminals in
 - Operating housings and operating housings with door

Mounting screws are concealed when the door is closed. Offers variable mounting options in compact enclosures, command panels and consoles.

Material:

- Sheet steel, zinc-plated

Supply includes:

- Assembly parts

Packs of	Model No.
6 pc(s).	2373.000

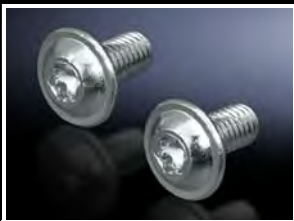
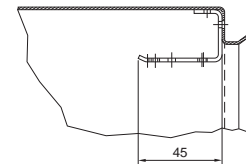
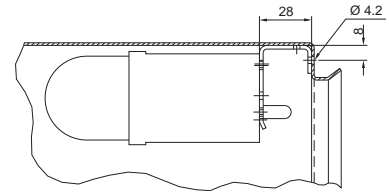

Multi-tooth screw

- M6 x 12 to fit:
- Cage nuts 4164.500
 - U nuts 4179.000
 - Threaded blocks 4162.000

- M8 x 12 to fit:
- Cage nuts 4165.500
 - U nuts 4180.000
 - Threaded blocks 4163.000

Multi-tooth drive for optimum transmission of torques, an extended tool life and increased safety and reliability when tightening and loosening screw connections.

Type of screw	Dimensions mm	Packs of	ModelNo.
Multi-tooth screws	M6 x 12 M8 x 12	300 pc(s). 300 pc(s).	2504.500 2504.800
Metal multi-tooth screws	5.5 x 13	300 pc(s).	2486.600
Metal multi-tooth screws for stainless steel	5 x 13	300 pc(s).	2486.400
Self-tapping screws			
– Hex screws	M5 x 10 M5 x 12	500 pc(s). 500 pc(s).	2504.000 2488.000
– Posidrive raised countersunk screws	M5 x 12	500 pc(s).	2489.000
– Pan-head screws, posidrive	M5 x 12	500 pc(s).	2489.500
– Multi-tooth pan-head screws	M5 x 12	500 pc(s).	2489.500
Self-tapping screws	ST 4.8 x 16	300 pc(s).	2487.000

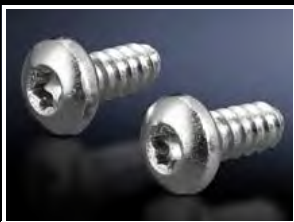

Metal multi-tooth screw

For the round holes Ø 4.5 mm in the enclosure section, punched rails and punched sections without mounting flanges.

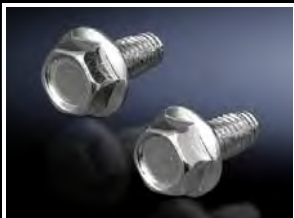

Self-tapping screw

For the round holes Ø 4.5 mm in the enclosure section, punched rails and punched sections without mounting flanges.



Self-tapping screw

Mark, drill and tighten in a single operation using electric or pneumatic tools.

- For metal thickness: 0.8 – 3 mm
 Length: 16 mm
 Usable length: 9.5 mm
 Width across flats: 8 mm

Interior installation

Assembly components

Connection kit

for separated frame VX IT

Every VX IT frame is easily converted to a rack suitable for dismantling. To this end, the frame sections in the roof and base frame must be separated, optionally in the width or depth. The four connection components are inserted into the frame section and screw-fastened. The external dimensions of the frame remain unchanged.

Supply includes:

- 4 connection components, internal
- 4 connection components, external
- Earth strap
- Assembly parts

Note:

- The maximum achievable IP protection category is restricted by separation of the frame
- The static load capacity of the frame structure is reduced to 8000 N

Packs of	Model No.
4 pc(s).	5302.037

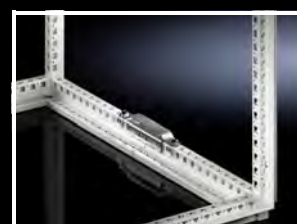

Interior installation

Component shelves for frame attachment

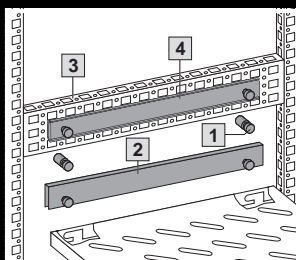
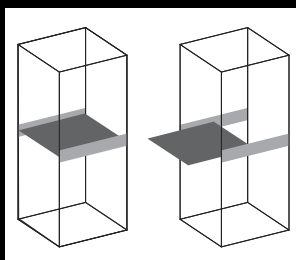

- 1** Assembly bolts
- 2** Mounting rails
- 3** Punched sections without mounting flanges
- 4** Telescopic slides

Component shelf for frame attachment

for empty enclosures VX and VX IT with enclosure width 600 and 800 mm

For installation in enclosures **without** 482.6 mm (19") accommodation.

Max. depth of component shelves = Enclosure depth - 100 mm.

Technical specifications:

- Mounting bolts or mounting rails may be installed on a 25 mm pitch pattern in the enclosure depth
- Mounting hole for handles provided.
- Component shelf, vented

Installation options:

- Static installation: Component shelf, 50 kg with fixing bolts on punched section without mounting flange
- Static installation: Component shelf, 100 kg with mounting rails on punched sections without mounting flange
- Depth variable: Component shelf with telescopic slides on punched sections without mounting flange

Material:

- Sheet steel

Surface finish:

- Spray-finished

Colour:

- RAL 7035

500 N version supply includes:

- Component shelf, vented
- 4 fixing bolts

1000 N version supply includes:

- Component shelf, vented
- 2 mounting rails

Enclosure width 600 mm

Load capacity N (static surface load)	500	500	500	500	1000	1000	1000	1000
Component shelf width mm	471	471	471	471	471	471	471	471
Component shelf depth mm	400	500	600	700	400	500	600	700
Component shelf height mm	29	29	29	29	45	45	45	45
Model No.	7164.035	7165.035	7166.035	7166.735	7464.035	7465.035	7466.035	7466.735

Enclosure width 800 mm

Load capacity N (static surface load)	500	500	500	500	1000	1000	1000	1000
Component shelf width mm	671	671	671	671	671	671	671	671
Component shelf depth mm	400	500	600	700	400	500	600	700
Component shelf height mm	29	29	29	29	45	45	45	45
Model No.	7184.035	7185.035	7186.035	7186.735	7484.035	7485.035	7486.035	7486.735



Accessories:

		Model No.							
Telescopic slides		7061.000	7081.000	7161.000	7161.700	7064.000	7065.000	7066.000	7066.700
Handles for component shelves		5501.730	5501.730	5501.730	5501.730	5501.730	5501.730	5501.730	5501.730
Cable support, hinged, with anti-kink device and clamp for enclosure depth mm	≤ 600	7163.560	7163.560	7163.560	7163.560	7163.560	7163.560	7163.560	7163.560
	> 600	7163.565	7163.565	7163.565	7163.565	7163.565	7163.565	7163.565	7163.565



Also required:

		Model No.
Punched section without mounting flange, 23 x 64 mm, as installation kit for enclosure depth, see page 993	500	8100.741
	600	8100.742
	800	8100.743
	1000/1200	8100.745

Interior installation

Component shelves for frame attachment

Component shelf, pull-out

for VX SE, PC, IW

For direct mounting on the vertical enclosure section.

Load capacity:

- 300 N surface load, static

Material:

- Sheet steel

Colour:

- RAL 7015

Supply includes:

- 2 telescopic slides

For enclosures ¹⁾		Support area		Model No.
Width mm	Depth mm	Width mm	Depth mm	
600	600	465	545	6902.960²⁾
600	800	465	745	6902.980

¹⁾ For enclosures without a mounting plate

²⁾ May also be installed in 800 mm deep enclosures (pull-out rear attachment)

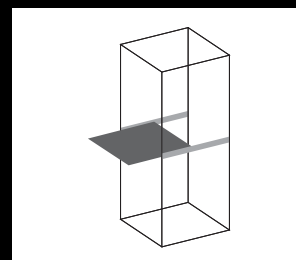

Component shelf, static installation

for VX SE, PC, IW

prepared for fan expansion kit

For direct mounting on the vertical enclosure section. Simply locate into 4 pre-fitted screws and secure.

Load capacity:

- 400 N surface load, static

Material:

- Sheet steel

Colour:

- RAL 7015

Supply includes:

- Assembly parts

For enclosures ¹⁾		Support area		Model No.
Width mm	Depth mm	Width mm	Depth mm	
600	600	507	550	8800.900
600	800	507	750	8800.910

¹⁾ For enclosures without a mounting plate



Accessories:

- Fan expansion kit 7980.XXX, see page 790

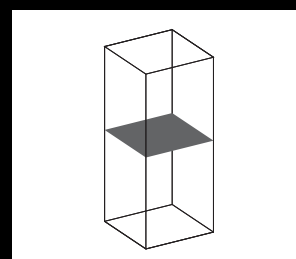
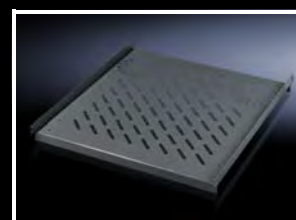

Drawer tray

for IW, PC

pull-out

Width 600 mm and depth 600 – 800 mm
Tray height: 800 mm

Load capacity:

- 400 N surface load, static

Material:

- Sheet steel

Colour:

- RAL 7035

Supply includes:

- 2 telescopic slides

Packs of	Model No.
1 pc(s).	6902.700



Interior installation

Component shelves for attachment to the 482.6 mm (19") system

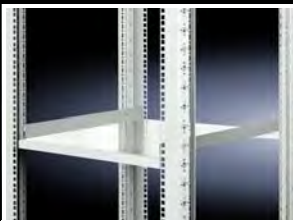
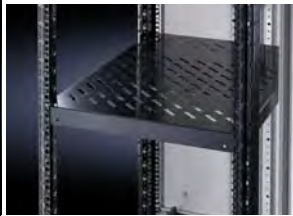
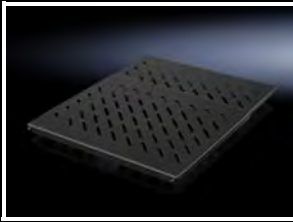

Component shelf, static installation

482.6 mm (19"), depth-variable for VX IT, TE

For static installation between two 482.6 mm (19") mounting levels.

- Contact width: 489 mm
- Depth-variable to adapt to individual distances between levels
- Tool-free, time-saving one-man assembly

Material:

- Sheet steel

Surface finish:

- Spray-finished

Colour:

- RAL 9005

Supply includes:

- Assembly parts

Distance between levels mm	Load capacity, static kg	Height U	Packs of	Model No.
400 - 600	50	½	1 pc(s).	5501.655
600 - 900	50	½	1 pc(s).	5501.665
400 - 600	100	1	1 pc(s).	5501.695
600 - 900	100	1	1 pc(s).	5501.705

Component shelf, static installation

for TE

The component shelf is attached directly at the side to the front and rear 482.6 mm (19") mounting frames for TE.

Material:

- Sheet steel

Colour:

- RAL 7035

Supply includes:

- Assembly parts

Note:

- Not suitable for combination with telescopic slides

Contact surface, width mm	505
Contact surface, depth mm	410
Distance between 482.6 mm (19") levels mm	495
Load capacity (static) N	300
Packs of	1 pc(s).
Model No.	7000.620

Component shelf, pull-out

482.6 mm (19") for VX IT, TE

For mounting between two 482.6 mm (19") mounting levels.

- Contact width: 419 mm
- Depth-variable to adapt to individual distances between levels
- Tool-free, time-saving one-man assembly from the enclosure front
- Self-locking
- Full withdrawal

Material:

- Sheet steel

Surface finish:

- Component shelf: Spray-finished
- Mounting kit/telescopic slides: Zinc-plated

Colour:

- Component shelf: RAL 9005

Supply includes:

- Component shelf, slotted
- Telescopic slide with mounting kit
- Assembly parts

Distance between levels mm	Load capacity, static kg	Height U	Depth mm	Packs of	Model No.
400 - 600	50	1	500	1 pc(s).	5501.675
600 - 900	50	1	700	1 pc(s).	5501.685
400 - 600	100	1½	500	1 pc(s).	5501.715
600 - 900	100	1½	700	1 pc(s).	5501.725

Accessories:

- Handle for component shelf 5501.730, see page 1011

Interior installation

Component shelves for attachment to the 482.6 mm (19") system

Component shelf, pull-out

for TE

For mounting between two 482.6 mm (19") mounting levels.

Benefits:

- Depth-variable to adjust to the distance between 482.6 mm (19") levels in a 25 mm pitch pattern
- Full withdrawal

Material:

- Base: Sheet steel

Surface finish:

- Base: Spray-finished
- Mounting kit/telescopic slides: Zinc-plated

Colour:

- RAL 7035

Supply includes:

- Component shelf, vented
- Telescopic slides with mounting kit

Contact surface, width mm	409
Contact surface, depth mm	500
Distance between 482.6 mm (19") levels mm	395 – 645
Load capacity (static) N	500
Packs of	1 pc(s).
Model No.	7000.625



Component shelf 1 U, static installation

482.6 mm (19")

for one 482.6 mm (19") mounting level

The ideal support surface for small active components such as modems or mini-hubs.

Load capacity:

- 10 kg surface load, static

Material:

- Sheet steel

Surface finish:

- Spray-finished

Colour:

- RAL 7035

Note:

- Usable height inside the U approx. 35 mm

Component shelf depth mm	Packs of	Model No.
140	1 pc(s).	7119.140



Also required:

- Cage nuts, see page 1002
- Screws, see page 1004

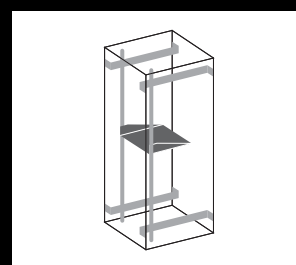

Interior installation

Component shelves for attachment to the 482.6 mm (19") system

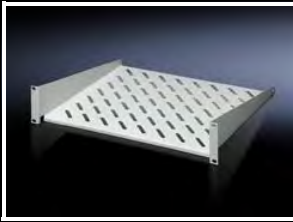

Component shelf 2 U, static installation

482.6 mm (19") for one 482.6 mm (19") mounting level

The ideal support surface for small active components such as modems or mini-hubs.

Load capacity:
– 25 kg surface load, static

Material:
– Sheet steel

Surface finish:
– Spray-finished

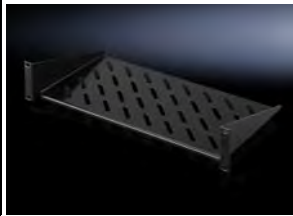

Component shelf, pull-out, 2 U

for one 482.6 mm (19") mounting level

For simple, front installation of wall-mounted or floor-standing enclosures with at least one 482.6 mm (19") mounting level. This complete set comprises the pre-configured variant including telescopic slides, moulded handle, flange and locking pins.

Benefits:
– Simple tool-free assembly
– Full withdrawal
– Self-locking

Material:
– Sheet steel

Surface finish:
– Spray-finished

Colour:
– RAL 9005

Supply includes:
– Component shelf, pre-configured
– Assembly parts



Component shelf depth mm	Colour	Packs of	Model No.
250	RAL 7035	1 pc(s).	7119.250
	RAL 9005	1 pc(s).	5501.615
400	RAL 7035	1 pc(s).	7119.400
	RAL 9005	1 pc(s).	5501.625



Also required:

- Cage nuts, see page 1002
- Screws, see page 1004

Contact surface, width mm	Contact surface, depth mm	Load capacity (static) N	Packs of	Model No.
430	300	250	1 pc(s).	5501.635

Interior installation

Accessories for component shelves

Telescopic slide

for component shelf for frame attachment

Static component shelves are easily converted to full withdrawal by exchanging the existing assembly bolts or mounting rails (heavy-duty version) for telescopic slides.

Technical specifications:

- For installation and locking on a 25 mm pitch pattern in the enclosure depth

Material:

- Sheet steel

Surface finish:

- Zinc-plated

Load capacity 50 kg

For component shelf depth mm	Packs of	Model No.
400	2 pc(s).	7061.000
500	2 pc(s).	7081.000
600	2 pc(s).	7161.000
700	2 pc(s).	7161.700

Load capacity 100 kg

For component shelf depth mm	Packs of	Model No.
400	2 pc(s).	7064.000
500	2 pc(s).	7065.000
600	2 pc(s).	7066.000
700	2 pc(s).	7066.700

- 1** Assembly bolts
- 2** Mounting rails
- 3** Telescopic slides

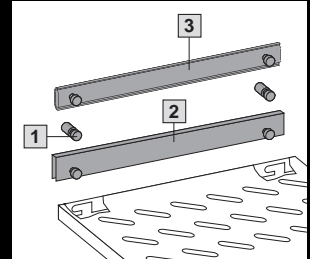

Cable support

Hinged, with anti-kink device and quick-release fastener

For secure routing of connection cables from the component shelves with telescopic pull-out to the clamping point. Kink-free cable routing in the central part via mobile chain links. The attachment may be released on both sides, thanks to the quick-release fastener.

Material:

- Sheet steel, zinc-plated
- Central part: Plastic

Supply includes:

- Cable support
- 2 mounting brackets
- Assembly parts

For enclosure depth mm	Packs of	Model No.
≤ 600	1 pc(s).	7163.560
> 600	1 pc(s).	7163.565

Note:

- Max. depth of component shelves = Enclosure depth - 200 mm



Handle

for pull-out component shelves

The component shelves are prepared for the attachment of handles.

Material:

- Die-cast zinc

Surface finish:

- Spray-finished

Packs of	Model No.
2 pc(s).	5501.730

Colour:

- Silver grey

Supply includes:

- Assembly parts

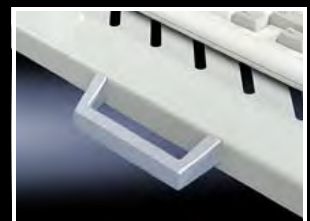

Fastening bolts

for slotted component shelves

For non-slip attachment of your components. The bolts are screwed into the longitudinal slots of the component shelf support surface. Consequently, they are infinitely adjustable and can be adapted to suit any appliance.

Packs of	Model No.
4 pc(s).	7115.000

Material:

- Steel

Surface finish:

- Clear-chromated



LED system light – Sensationally bright



Optimum illumination

- Innovative LED technology for even more light into the very last corner
- Intelligent lighting, tailored to the geometry of the enclosure, thanks to a special optical cover with Fresnel structure
- Optical cover with two different Fresnel structures
- The cover is easily rotated – to adapt the light distribution to the current installation situation
- Enormous luminous intensity up to 1200 lumens, directed selectively into the enclosure

Simple assembly

- Fast, tool-free assembly thanks to a latching hook system on a 25 mm pitch pattern of holes; simply latch and secure
- Optional screw-fastening also available, or opt for complete flexibility with a magnetic attachment freely positionable inside the enclosure
- May be fitted horizontally and vertically with no loss of space in the enclosure; existing rails and sections can simply be covered
- Lights with motion detectors are equipped with a rotating LED board as standard, allowing the direction of light to be perfectly adapted to any installation situation

Flexible connection

- Rotating connectors support installation in the most confined spaces
- Simple through-wiring based on the plug & play system
- Variants with integral motion detectors eliminate the need for installing separate door-operated switches
- If additionally equipped with a socket, electricity will be available whenever it is needed for maintenance work
- Suitable for immediate, global use with wide-range voltage 100 – 240 V (AC) and 24 V (DC)

New – socket box as a plug-in system

- The alternative to the LED system light with integrated socket
- Easier planning for international projects – same light, but with a country-specific socket
- No additional wiring required, thanks to simple connection technology and integration of the LED system light into the circuit
- Socket modules can be easily replaced to suit the user market via plug and play



LED system light



Baying enclosure system VX25 Page 116 **Free-standing enclosure system VX SE** Page 142 **Compact enclosures AX** Page 84

Benefits:

- Optimum illumination of the entire enclosure
- Optionally with clip, screw or magnetic attachment
- Equipment to suit every application

Material:

- Plastic
- Aluminium

Colour:

- Enclosure: RAL 7016

Protection class:

- II (all-insulated)

Light colour:

- 4000 K (neutral white)

Supply includes:

- Assembly screws





Note:

- Connection accessories should be ordered separately

Model No.	2500.300	2500.310	2500.311	2500.312	2500.313	Page
Output (lumens)	1200	1200	1200	1200	1200	
Length (mm)	437	437	437	437	437	
Motion sensor	■	■	■	■	■	
Rated operating voltage	100 – 240 V AC	■	■	■	■	
	24 V DC	–	–	–	–	
Equipment	Socket	–	D, earthing-pin	GB	F/B	CH
	90° rotating connector	■	■	■	■	■
	Adjustable light direction	■	■	■	■	■
	Adjustable light distribution	■	■	■	■	■
Approvals	UL/cUL	■	–	–	–	–
	CSA	■	–	–	–	–
	CCC	■	–	–	–	–
	ENEC	■	■	■	■	■
Installation type	Screw-fastening	■	■	■	■	■
	Clip attachment	■	■	■	■	■
	Magnetic attachment to surfaces (accessory)	■	–	–	–	–
Connection options	Infeed	3-pole	3-pole	3-pole	3-pole	3-pole
	Through-wiring	3-pole	3-pole	3-pole	3-pole	3-pole
	Door-operated switch (accessory)	–	–	–	–	–
Mounting options ¹⁾	Enclosures with a 25 mm pitch pattern	Screw fastening/clip	Directly on the profile	Directly on the profile	Directly on the profile	Directly on the profile
Accessories						
Rail for interior installation AX	see page	see page	see page	see page	see page	989
Mounting bracket	6205.100	6205.100	6205.100	6205.100	6205.100	1000
Mounting kit magnet	2500.490	–	–	–	–	1024
Door-operated switch	–	–	–	–	–	
Door-operated switch, UL	–	–	–	–	–	
Connection accessories						
Infeed, 2-pole	–	–	–	–	–	
Infeed, 2-pole, UL	–	–	–	–	–	
Infeed, 3-pole	2500.400	2500.400	2500.400	2500.400	2500.400	1023
Infeed, 3-pole, UL	2500.500	–	–	–	–	1023
Through-wiring, 2-pole	–	–	–	–	–	
Through-wiring, 2-pole, UL	–	–	–	–	–	
Through-wiring, 3-pole	2500.430	2500.430	2500.430	2500.430	2500.430	1023
Through-wiring, 3-pole, UL	2500.530	–	–	–	–	1023

¹⁾ The internal mounting rail AX and the mounting bracket are required when installing in compact enclosures AX

LED system light

						
Model No.	2500.314	2500.320	2500.200	2500.210	2500.211	Page
Output (lumens)	1200	1200	900	900	900	
Length (mm)	437	437	437	437	437	
Motion sensor	■	■	–	–	–	
Rated operating voltage	100 – 240 V AC	100 – 125 V AC	–	■	■	
	24 V DC	–	■	–	–	
Equipment	Socket	USA / CDN	–	–	D, earthing-pin	GB
	90° rotating connector	■	■	■	■	■
	Adjustable light direction	■	■	–	–	–
	Adjustable light distribution	■	■	■	■	■
Approvals	UL/cUL	■	■	■	–	–
	CSA	■	–	■	–	–
	CCC	–	■	■	–	–
	ENEC	■	–	■	■	■
Installation type	Screw-fastening	■	■	■	■	■
	Clip attachment	■	■	■	■	■
	Magnetic attachment to surfaces (accessory)	–	■	■	–	–
Connection options	Infeed	3-pole	2-pole	3-pole	3-pole	3-pole
	Through-wiring	3-pole	2-pole	3-pole	3-pole	3-pole
	Door-operated switch (accessory)	–	–	■	■	■
Mounting options ¹⁾	Enclosures with a 25 mm pitch pattern		Directly on the profile	Directly on the profile	Directly on the profile	Directly on the profile
	Screw fastening/clip		Directly on the profile	Directly on the profile	Directly on the profile	Directly on the profile

Accessories

Rail for interior installation AX	see page	see page	see page	see page	see page	989
Mounting bracket	6205.100	6205.100	6205.100	6205.100	6205.100	1000
Mounting kit magnet	–	2500.490	2500.490	–	–	1024
Door-operated switch	–	–	2500.460	2500.460	2500.460	1024
Door-operated switch, UL	–	–	2500.470	–	–	1024

Connection accessories

Infeed, 2-pole	–	–	–	–	–	
Infeed, 2-pole, UL	–	2500.410	–	–	–	1023
Infeed, 3-pole	–	–	2500.400	2500.400	2500.400	1023
Infeed, 3-pole, UL	2500.500	–	2500.500	–	–	1023
Through-wiring, 2-pole	–	–	–	–	–	
Through-wiring, 2-pole, UL	–	2500.440	–	–	–	1023
Through-wiring, 3-pole	–	–	2500.430	2500.430	2500.430	1023
Through-wiring, 3-pole, UL	2500.530	–	2500.530	–	–	1023

¹⁾ The internal mounting rail AX and the mounting bracket are required when installing in compact enclosures AX

Rittal – The System.





Connection accessories

see page 1023

System accessories

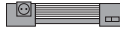
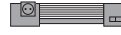
LED system light

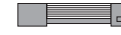
					
Model No.	2500.212	2500.213	2500.214	2500.220	Page
Output (lumens)	900	900	900	900	
Length (mm)	437	437	437	437	
Motion sensor	–	–	–	–	
Rated operating voltage	100 – 240 V AC	■	■	100 – 125 V AC	–
	24 V DC	–	–	–	■
Equipment	Socket	F/B	CH	USA / CDN	–
	90° rotating connector	■	■	■	■
	Adjustable light direction	–	–	–	–
	Adjustable light distribution	■	■	■	■
Approvals	UL/cUL	–	–	■	■
	CSA	–	–	■	■
	CCC	–	–	–	■
	ENEC	■	■	■	■
Installation type	Screw-fastening	■	■	■	■
	Clip attachment	■	■	■	■
	Magnetic attachment to surfaces (accessory)	–	–	–	■
Connection options	Infeed	3-pole	3-pole	3-pole	2-pole
	Through-wiring	3-pole	3-pole	3-pole	2-pole
	Door-operated switch (accessory)	■	■	■	■
Mounting options ¹⁾	Enclosures with a 25 mm pitch pattern				
	Screw fastening/clip	Directly on the profile	Directly on the profile	Directly on the profile	Directly on the profile

Accessories

Rail for interior installation AX	see page	see page	see page	see page	989
Mounting bracket	6205.100	6205.100	6205.100	6205.100	1000
Mounting kit magnet	–	–	–	2500.490	1024
Door-operated switch	2500.460	2500.460	2500.460	2500.460	1024
Door-operated switch, UL	–	–	2500.470	2500.470	1024

Connection accessories

Infeed, 2-pole	–	–	–	–	
Infeed, 2-pole, UL	–	–	–	2500.410	1023
Infeed, 3-pole	2500.400	2500.400	–	–	1023
Infeed, 3-pole, UL	–	–	2500.500	–	1023
Through-wiring, 2-pole	–	–	–	–	
Through-wiring, 2-pole, UL	–	–	–	2500.440	1023
Through-wiring, 3-pole	2500.430	2500.430	–	–	1023
Through-wiring, 3-pole, UL	–	–	2500.530	–	1023

¹⁾ The internal mounting rail AX and the mounting bracket are required when installing in compact enclosures AX





Rittal – The System.



Socket box

see page 1022

LED system light

					
Model No.	2500.100	2500.104	2500.110	2500.114	Page
Output (lumens)	400	400	600	600	
Length (mm)	262	262	337	337	
Motion sensor	-	-	-	-	
Rated operating voltage	100 – 240 V AC	■	■	■	
	24 V DC	-	-	-	
Equipment	Socket	-	-	-	
	90° rotating connector	-	-	-	
	Adjustable light direction	-	-	-	
	Adjustable light distribution	-	-	-	
Approvals	UL/cUL	-	■	-	■
	CSA	-	■	-	■
	CCC	■	■	■	■
	ENEC	■	■	■	■
Installation type	Screw-fastening	■	■	■	■
	Clip attachment	■	■	■	■
	Magnetic attachment to surfaces (accessory)	■	■	■	■
Connection options	Infeed	2-pole	2-pole	2-pole	2-pole
	Through-wiring	2-pole	2-pole	2-pole	2-pole
	Door-operated switch (accessory)	■	■	■	■
Mounting options ¹⁾	Enclosures with a 25 mm pitch pattern		Directly on the profile	Directly on the profile	Directly on the profile
	Screw fastening/clip		Directly on the profile	Directly on the profile	Directly on the profile

Accessories

Rail for interior installation AX	see page	see page	see page	see page	989
Mounting bracket	6205.100	6205.100	6205.100	6205.100	1000
Mounting kit magnet	2500.490	2500.490	2500.490	2500.490	1024
Door-operated switch	2500.460	-	2500.460	-	1024
Door-operated switch, UL	-	2500.470	-	2500.470	1024

Connection accessories

Infeed, 2-pole	2500.420	-	2500.420	-	1023
Infeed, 2-pole, UL	-	2500.520	-	2500.520	1023
Infeed, 3-pole	-	-	-	-	
Infeed, 3-pole, UL	-	-	-	-	
Through-wiring, 2-pole	2500.450	-	2500.450	-	1023
Through-wiring, 2-pole, UL	-	2500.550	-	2500.550	1023
Through-wiring, 3-pole	-	-	-	-	
Through-wiring, 3-pole, UL	-	-	-	-	

¹⁾ The internal mounting rail AX and the mounting bracket are required when installing in compact enclosures AX

Rittal – The System.



IT LED system light

see page 1027

Socket box – The plug-in system



A global player

- Socket modules in all standard, country-specific variants
- UL variant for the North American market
- Socket modules can be easily replaced to suit the user market via plug and play



Simple assembly

- Easy to screw securely to the round holes in the enclosure profile
- No loss of space thanks to perfect integration into the profile
- No obstruction when installing and removing the mounting plate
- Supports flexible installation throughout the entire enclosure and on the tubular door frame



Fast connection

- Connection ready to plug in without any wiring work
- Direct integration of the LED system light into the circuit
- Same connection accessories as for LED system light
- Multiple socket boxes can be cascaded with numerous LED system lights

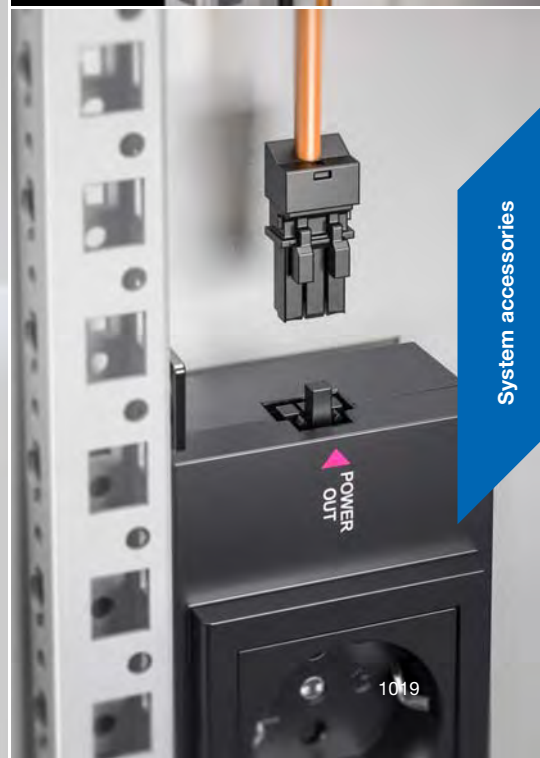

Interior installation

LED system light



The optimum system solution for improved flexibility

The socket box turns the LED system light into an all-in-one system, making it possible to easily install additional sockets in six country-specific variants anywhere in the enclosure.

A key advantage of this solution is that the appropriate socket for the end user's particular country can be easily installed via plug and play when the system is delivered. There is no need to replace the LED system light with one that has a suitable socket. All components are ready to plug in and can be installed without manual wiring.

Configuration examples

Free-standing enclosure
LED system light with socket and motion detector

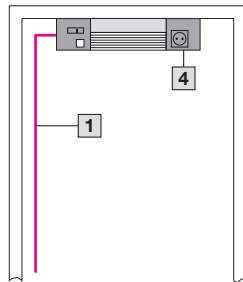

Free-standing enclosure
LED system light with socket and additional door-operated switch

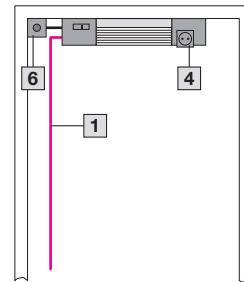

Free-standing enclosure
LED system light without socket or motion sensor, but with additional door-operated switch and additional socket box

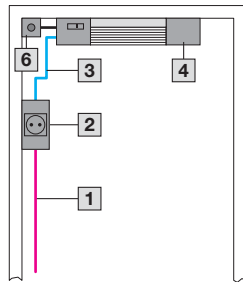

Free-standing enclosure
LED system light fastened to the side with motion detector and additional socket box

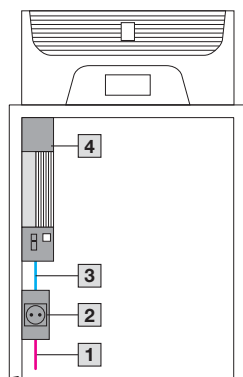

Free-standing enclosure

LED system light with motion detector and additional socket box

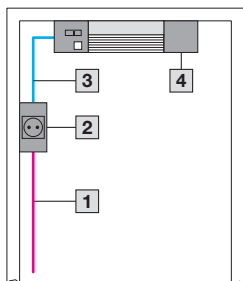

Bayed enclosure with through-wiring via socket box

Enclosure 1:

LED system light with motion detector and additional socket boxes

Enclosure 2:

LED system light without socket or motion detector, but with additional door-operated switch and additional socket box

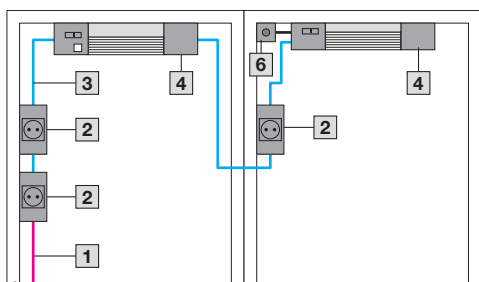

Bayed enclosure with through-wiring via T distributor

Enclosure 1:

LED system light with motion detector and additional socket boxes

Enclosure 2:

LED system light without socket or motion detector, but with additional door-operated switch and additional socket box

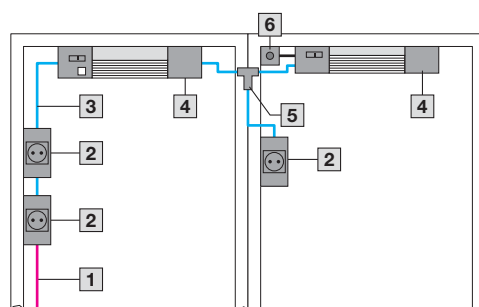

- 1 Infeed
- 2 Socket box
- 3 Through-wiring
- 4 LED system light (various types)
- 5 T distributor
- 6 Door-operated switch with connection cable

Completely UL-compliant construction

The entire system can be constructed in full compliance with UL requirements if UL-approved components (infeed, LED system light, through-wiring and socket box) are used.



Interior installation

LED system light



Socket box

for LED system light

In combination with the LED system light, the socket box creates a flexible modular system for international use.

Benefits:

- Identical connection accessories as for LED system light
- Cascadable with LED system light
- Supports flexible installation throughout the entire enclosure and on the tubular door frame
- No additional wiring required, thanks to simple connection technology and integration of the LED system light into the circuit

Material:

- Plastic

Colour:

- RAL 7016

Supply includes:

- Assembly parts

Configuration examples:

See from page 1020.

- 1 Infeed
- 2 Socket box
- 3 Through-wiring
- 4 LED system light
- 5 T distributor

Socket	UL	Packs of	Model No.
	D, earthing-pin	–	1 pc(s). 2500.710
	GB	–	1 pc(s). 2500.711
	F/B	–	1 pc(s). 2500.712
	CH	–	1 pc(s). 2500.713
	US	■	1 pc(s). 2500.714
	CN	–	1 pc(s). 2500.715



Also required:

- Depending on the application, through-wiring or a 3-pole infeed may be required, see page 1023



Accessories:

- T distributor, see page 1023
- Through-wiring, 3-pole, see page 1023
- Infeed, 3-pole, see page 1023

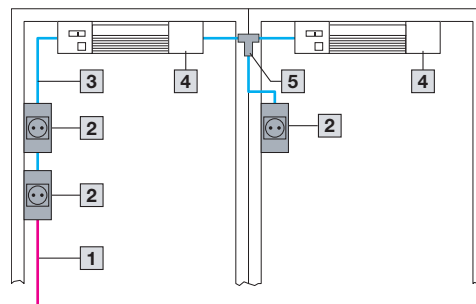

Interior installation

LED system light

Connection accessories

for LED system light

The following components can be used for time-saving, easy installation of the lights:

+ Accessories:

- Cable ties for quick assembly, see page 1061

	Connection cable for	ENEC	UL	Length mm	Packs of	Model No.	
						orange	black
1	Infeed, 3-pole, 100 – 240 V AC	■	■	3000	1 pc(s).	2500.500	-
	Infeed, 3-pole, 100 – 240 V AC	■	-	3000	5 pc(s).	2500.400	-
2	Infeed, 2-pole, 100 – 240 V AC	-	■	3000	1 pc(s).	2500.520	-
	Infeed, 2-pole, 100 – 240 V AC	■	-	3000	5 pc(s).	2500.420	-
3	Infeed, 2-pole, 24 V DC	■	■	3000	5 pc(s).	-	2500.410
4	Through-wiring, 3-pole, 100 – 240 V AC	■	-	200	1 pc(s).	2500.435	-
	Through-wiring, 3-pole, 100 – 240 V AC	■	■	1000	1 pc(s).	2500.530	-
	Through-wiring, 3-pole, 100 – 240 V AC	■	-	1000	5 pc(s).	2500.430	-
5	Through-wiring, 2-pole, 100 – 240 V AC	-	■	3000	1 pc(s).	2500.550	-
	Through-wiring, 2-pole, 100 – 240 V AC	■	-	1000	5 pc(s).	2500.450	-
6	Through-wiring, 2-pole, 24 V DC	■	■	1000	5 pc(s).	-	2500.440

A Connection cable for infeed

B Connection cable for through-wiring

C Door-operated switch with connection cable (not required for LED system light with integral motion sensor)

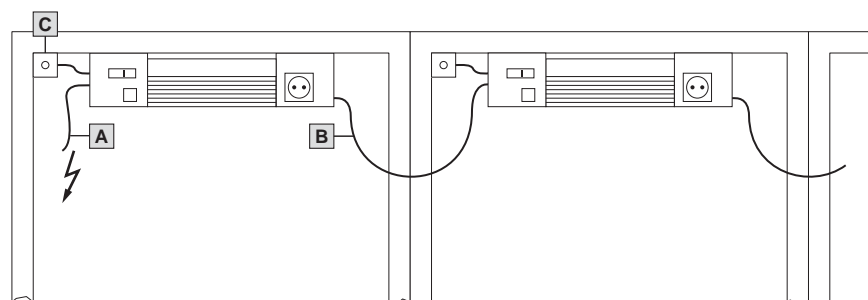

T distributor

with two sockets and one connector

For creating safe, shock-hazard-protected junctions when wiring LED system lights and socket boxes.

Packs of	Model No.
5 pc(s).	2500.680

Connection accessories for self-assembly

for LED system light

For individual wiring with commercially available cables.

Type	Input voltage	UL	Packs of	Model No.
Jack, 3-pole	100 – 240 V	■	5 pc(s).	2500.600
Jack, 2-pole	24 V DC	■	5 pc(s).	2500.610
Jack, 2-pole	100 – 240 V	■	5 pc(s).	2500.620
Connector, 3-pole	100 – 240 V	■	5 pc(s).	2500.630
Connector, 2-pole	24 V DC	■	5 pc(s).	2500.640
Connector, 2-pole	100 – 240 V	■	5 pc(s).	2500.650

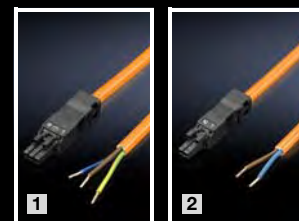

Interior installation

LED system light



Door-operated switch

with connection cable for LED system light

Supply includes:

- Assembly parts

	ENEC	UL	Length mm	To fit	Packs of	Model No.
						Black
Connection cable	■	–	800	230 V AC/24 V DC, 1 A	1 pc(s).	2500.460
	–	■	800		1 pc(s).	2500.470



Door-operated switch

without connection cable for self-assembly

- With normally closed contact and normally open contact
- Custom wiring of the LED system light when combined with the connection cable for door-operated switch
- Can be used to control the various Rittal climate control solutions when combined with standard cables

Technical specifications	UL	Packs of	Model No.
240 V, 6 A 125 V DC, 8 A 24 V, 6 A 24 V DC, 6 A	■	1 pc(s).	4127.010



Also required:

- For the installation in TE: Mounting kit **7888.615**



Connection cable

for door-operated switch for LED system light

Connection cable with pre-assembled connector for simple, fast connection of the LED system light. With open end for cutting the connection cable to the required individual length.

Length mm	UL	Packs of	Model No.
3000	–	1 pc(s).	2500.660
3000	■	1 pc(s).	2500.670

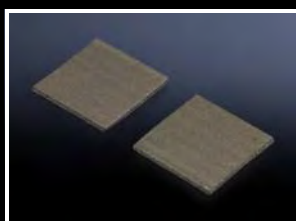

Mounting kit magnet

for LED system light

For sticking onto the rear of lights without a socket.

Packs of	Model No.
2 pc(s).	2500.490

Interior installation

LED compact system light

LED compact system light in 24 V (DC) version

- Max. EMC compatibility
- Protected, as it operates within the safety extra-low voltage range
- Door operated switch connection supported
- Integral through-wiring
- Vertically hinged light cone

Material:

- Light body: Extruded aluminium
- Light cover: Polycarbonate (halogen-free)
- Light ends: PC-ABS

Colour:

- Similar to RAL 7035

Protection category IP to IEC 60 529:

- IP 20

Supply includes:

- LED compact system light with clip and screw mounting kits, assembly parts

Model No.	4140.810	4140.820	4140.830	4140.840
Rated voltage	24 V (DC) (±10%)			
Number of LEDs	10	20	30	40
Degree of protection	III (SELV)			
Width (B1) mm	230	330	430	530
Mounting distance CLIP (B2) mm	175	275	375	475
Mounting distance, screw attachment (B3) mm	250	350	450	550
Rated current A ¹⁾	0.04	0.08	0.12	0.16
Switch	Integral on/off/door-operated switch mode			

¹⁾ Maximum buying up to a total rated current strength of 2 amps

! Also required:

- LED connection cable, see page 1026 or
- Door-operated switch with LED connection cable, see page 1026

+ Accessories:

- Mounting kit magnet for LED compact system light, see page 1025
- Door-operated switch with LED connection cable, see page 1026
- LED connection cable, see page 1026
- Adaptor power pack, see page 1026

Note:

- Only intended for use in enclosures and sealed cases!
- When using on customer-supplied power packs, it is important to obtain the requisite approvals depending on the application.

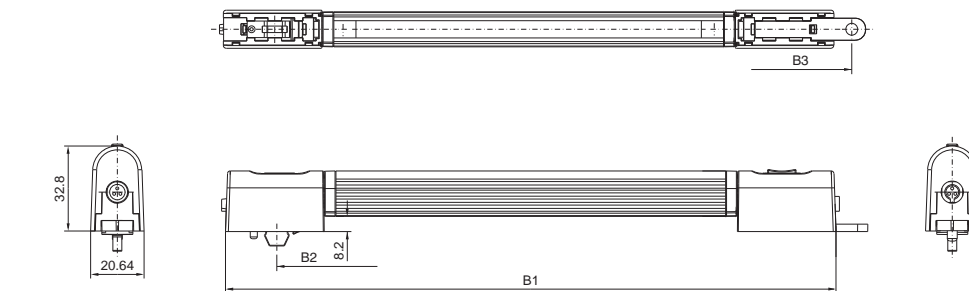

Mounting kit magnet

for LED compact system light

For reliable adhesion on all sheet steel surfaces.

Packs of	Model No.
2 pc(s).	4140.000



Interior installation

LED compact system light



Connection accessories for LED compact system light

	Connection cable	Length mm	Packs of	Model No.
1	LED connection cable	3000	1 pc(s).	4315.800
Door-operated switch				
2	With LED connection cable	3000	1 pc(s).	4315.810
3	With LED interconnecting cable	1000	1 pc(s).	4315.820
Interconnecting cable				
4	LED interconnecting cable	600	1 pc(s).	4315.830
		1000	1 pc(s).	4315.840
		3000	1 pc(s).	4315.850
Adaptor power pack				
5	Adaptor power pack	Technical specifications 100 – 230 V/24 V (DC), 1 A	Packs of 1 pc(s).	Model No. 4315.860

Layout diagram for LED compact system light 24 V (DC):

- 1 Connection cable
- 2 Door-operated switch with LED connection cable (open end/cable bush)
- 3 Door-operated switch with LED interconnecting cable
- 4 LED interconnecting cable for through-wiring

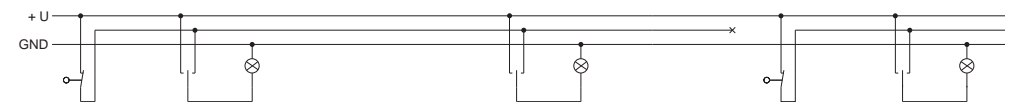
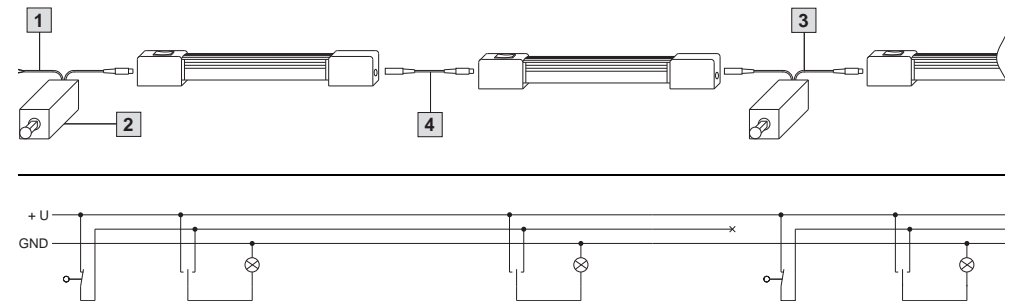

IT LED system light

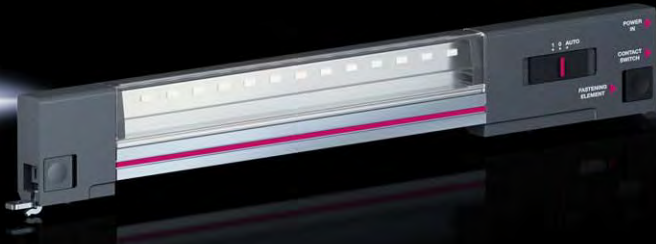

Network/server racks VX IT Page 686 Network racks TE 8000 Page 704 Wall-mounted enclosures AX/EL from page 715

Benefits:

- Plug and play compatibility system
- Optimum illumination of the entire IT rack
- Optionally with clip, screw or magnetic attachment
- Equipment to suit every application
- Ready to use immediately, thanks to plug-in connection cable
- Attachment with no loss of U in the rack

Type:

- All-insulated, with internal fuse (T 2A) for operation with Europlug (to CEE 7/16) and IEC 320 connector

Material:

- Plastic
- Aluminium

Colour:

- Enclosure: RAL 7016

Protection class:

- II (all-insulated)

Light colour:

- 4000 K (neutral white)

Supply includes:

- Mounting kit magnet
- Assembly screws

Note:

- Connection accessories should be ordered separately
- The two plug-in connection cables should only be used with the IT LED system light. Use with all other Rittal system lights or external products is inadmissible.
- Cascading of multiple IT LED system lights is not possible

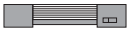
Model No.				
			7859.000	Page
Output (lumens)			600	
Length (mm)			337	
Motion sensor			–	
Rated operating voltage	100 – 240 V AC, 50/60 Hz		■	
Equipment	Socket		–	
	90° rotating connector		■	
	Adjustable light direction		■	
	Adjustable light distribution		■	
Approvals	UL/cUL		■	
	CSA		■	
	CCC		■	
Installation type	Screw-fastening		■	
	Clip attachment		■	
	Magnetic attachment to surfaces		■	
Connection options	Infeed		2-pole	
	Door-operated switch (accessory)		■	
Installation options	Enclosures with a 25 mm pitch pattern	Screw fastening/clip	Directly on the profile	
	TE 8000, IT enclosure based on AX/EL	Mounting kit magnet	■	
Accessories				
Door-operated switch			2500.460	1024
Door-operated switch, UL			2500.470	1024
Also required: Connection accessories				
1	Connection cable with Europlug EN 50075, CEE 7/16, type: H05VV-F, 2 x 0.75 mm ² , ready for connection, black, length 2 m, packs of 1		7859.010	
2	Connection cable with IEC 60 320 C18 connector, UL version, to fit IEC 60 320 C13 sockets type: SJT 2 x 18 60D, ready for connection, black, length 2 m, packs of 1		7859.020	



Connection cable with Europlug EN 50075



Connection cable with IEC 60 320 C18 connector

Interior installation

EMC



EMC side panel

for VX

Automatic potential equalisation via assembly components, and a high level of EMC protection thanks to a special EMC seal.

Material:

- Sheet steel, 1.5 mm

Surface finish:

- Magnesium zinc coated, powder-coated on the outside

Colour:

- RAL 7035

Protection category IP to IEC 60 529:

- IP 55

Supply includes:

- Assembly parts

For enclosures		Packs of	Model No.
Height mm	Depth mm		
2000	600	2 pc(s).	8106.760
2000	800	2 pc(s).	8108.760



EMC shielding seal

for VX

For EMC-compliant shielding of the baying point in conjunction with external baying connector.

Protection category IP to IEC 60 529:

- IP 55 in conjunction with external baying connector

Supply includes:

- 8 m

Packs of	Model No.
1 pc(s).	8800.695



Also required:

- Baying connector, external, page 912



EMC divider panel seal

for VX

With bayed EMC enclosure systems and when using a zinc-plated divider panel, this seal ensures optimum contact and shield attenuation.

Material:

- PU foam with electrically conductive sheathing

Supply includes:

- 6 m

Packs of	Model No.
1 pc(s).	4348.500

Rail

for EMC shielding bracket and strain relief

Combined rail for strain relief and EMC contacting of inserted cables.

Design:

- C rail to accommodate cable clamps
- T-head cut-outs on a 40 mm pitch pattern for cable clamping using cable ties

Benefits:

- Additional contacting on the left or right of the rail via existing holes (9 mm diameter)
- Prepared for tool-free mounting of EMC shielding brackets

Installation options:

- On the horizontal/vertical VX, VX SE, PC enclosure section
- On the mounting plate, may also be fitted without a retaining bracket

Material:

- Extruded aluminium section

Surface finish:

- Chrome-free passivated

Supply includes:

- 1 rail
- 2 retaining brackets
- Assembly parts

For enclosure width mm	Length mm	Packs of	Model No.
600	553	1 pc(s).	2388.650
800	753	1 pc(s).	2388.850
1000	953	1 pc(s).	2388.050
1200	1153	1 pc(s).	2388.125



Also required:

- EMC shielding bracket, see page 1029
- Cable clamps, see page 1060



Accessories:

- Support bracket or spacer, see page 1001
- Quick-assembly block, see page 1001
- Angle piece, see page 1001
- Earth straps, see page 1033
- Earthing braid, see page 1033



Possible alternative:

- C rails 30/15, see page 996

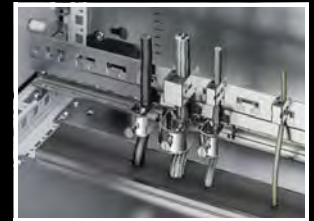

EMC shielding bracket

Quick assembly without the use of tools: Press the EMC shielding bracket against the cable shield and clip into the rail. Diameter changes are compensated in full by the spring of the EMC shielding bracket.

Material:

- Sheet steel

Surface finish:

- Zinc-plated

For shield diameter mm	Packs of	Model No.
3 – 10	10 pc(s).	2388.100
4 – 15	10 pc(s).	2388.150
10 – 20	10 pc(s).	2388.200
15 – 28	10 pc(s).	2388.280



EMC gland plate

for VX, VX SE

For shielded cables with a maximum diameter of 20 mm. Combined EMC/IP seal provides low-resistance contact between cable shield and gland plate. For all 400, 500, 600 and 800 mm deep enclosures in conjunction with standard gland plates.

Material:

- Sheet steel

Surface finish:

- Zinc-plated

Supply includes:

- 1 gland plate with twin hammer-head punching
- 1 sliding base plate
- 2 EMC/IP seals

Width mm	Packs of	Model No.
600	1 pc(s).	8618.820
800	1 pc(s).	8618.821
1000	1 pc(s).	8618.822¹⁾
1200	1 pc(s).	8618.823¹⁾

¹⁾ For one enclosure half only

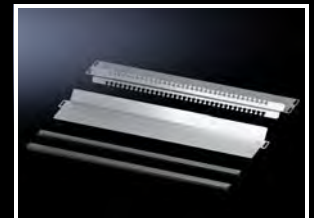

Interior installation

EMC



EMC cable gland

The cable sheathing may optionally be interrupted at the contact point or removed completely inside the enclosure. The cable shielding in the enclosure is retained. The supplied lock nut cuts automatically into the paint when screwed down, thus creating a conductive connection.

Protection category IP to IEC 60 529:

- IP 68

Possible alternative:

- Cable gland Hygienic Design, see page 1057

Cable gland, metric

Size	Cable diameter mm	Minimum ¹⁾ shield diameter mm	Packs of	Model No.
M16	4.5 – 10	3	5 pc(s).	2843.160
M20	6 – 12	5	5 pc(s).	2843.200
M25	11 – 17	8	5 pc(s).	2843.250
M32	15 – 21	10	1 pc(s).	2843.320
M40	19 – 28	15	1 pc(s).	2843.400
M50	27 – 38	19	1 pc(s).	2843.500
M63	34 – 44	30	1 pc(s).	2843.630

¹⁾ Minimum shield diameter = cable diameter minus cable sheathing



EMC shield bus

Made of corrosion-proof steel strip, 75 mm² cross section, for cable shield contact.

Supply includes:

- Assembly parts

Rail length mm	Connections	Packs of	Model No.
375	10	1 pc(s).	2413.375
550	16	1 pc(s).	2413.550

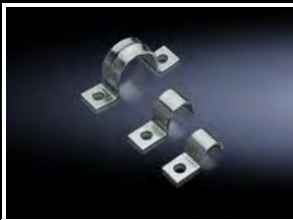

EMC earth clamp

The clamps may be used directly on the device or operating equipment on the mounting plate for cable shield contact.

Material:

- Sheet steel

Surface finish:

- Zinc-plated

Size mm	Packs of	Model No.
4	50 pc(s).	2367.040
6	50 pc(s).	2367.060
8	50 pc(s).	2367.080
12	50 pc(s).	2367.120
16	50 pc(s).	2367.160
20	25 pc(s).	2367.200¹⁾

¹⁾ 2 mounting brackets



Contact cutter

The contact cutter enables EMC-compatible preparation of the contact point e.g. for earthing braids. Plastic-bound abrasive with guide pin for round system punchings. With location point for drill, grinder etc.

For	Model No.
Frame section	2414.000
Earthing bolts ¹⁾	2414.500

¹⁾ Not necessary with VX, VX SE



Contact paint

Contact paint prevents the corrosion of conductive, unprotected contact points.

Contents:

- 12 ml

Packs of	Model No.
1 pc(s).	2415.000

Interior installation

VX25 for areas at risk of earthquakes

The versions listed have been tested and meet the requirements to Telcordia GR 63-CORE. They should be seen as a comparative variable to the customer's own plant, since empty enclosures cannot be certified.

Note:

- Further information can be found in the white paper "Earthquake protection for switchgear systems" on the Internet

VX25 for earthquake zone 1 and 2 to Telcordia GR 63-CORE

VX 8806.000:
W x H x D: 800 x 2000 x 600 mm,
see page 125

Fitted with:

- Side panels, see page 901
- Base/plinth VX (corner pieces with base/plinth trim panels, front and rear and side base/plinth trim panels, 100 mm high), see page 881/882

VX25 for earthquake zone 3 to Telcordia GR 63-CORE

VX 8806.000:
W x H x D: 800 x 2000 x 600 mm,
see page 125

Fitted with:

- Side panels, see page 901
- Comfort handle VX, see page 937
- Earthquake base/plinth, see page 1032

VX25 for earthquake zone 4 to Telcordia GR 63-CORE

VX 8806.000:
W x H x D: 800 x 2000 x 600 mm,
see page 125

Fitted with:

- Side panels, see page 901
- Comfort handle VX, see page 937
- Earthquake base/plinth, see page 1032
- Earthquake kit, see page 1032



Interior installation

VX25 for areas at risk of earthquakes

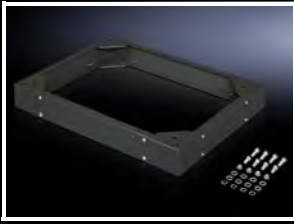

Earthquake base/plinth

for VX
Height 100 mm

- For stable attachment of the earthquake-resistant enclosure to the subsurface.
- External metric M6 thread for a stable connection to the subsurface from the outside

Material:

- Corner piece: Sheet steel, 5 mm
- Trim panels: Sheet steel, 2 mm

Surface finish:

- Powder-coated

Colour:

- RAL 7022

Supply includes:

- 1 pc(s) =
4 corner pieces,
2 depth stays,
1 trim panel each front and rear
Fully assembled.

For enclosures W x D mm	Packs of	Model No.
800 x 600	1 pc(s).	8601.860



Earthquake kit

for VX

Material:

- Sheet steel

Surface finish:

- Zinc-plated

Supply includes:

- 1 pc(s) =
2 side reinforcements, bottom
4 bracing struts, sides
6 gusset plates
2 door safety brackets
4 punched sections with
mounting flanges 23 x 64 mm
2 mounting rails 18 x 39 mm
8 angle plates
Mounting plate attachment
Assembly parts

For enclosures W x H x D mm	Packs of	Model No.
800 x 2000 x 600	1 pc(s).	8618.600

Interior installation

Earthing

Earth straps

For configuring a reliable earthing connection with perfect contact

- With ring terminals in M6 and M8 to match the earthing screws
- Length-optimised and ready to install

Enclosure	Connection option		
	Door/cover	Enclosure	Mounting plate
KX	M6	M6	M6
AX	M8	M8	M8
VX	M8	M8	M8
Ex	M8	M8	M8
TP	M6	M8	M8
VX SE	M8	M8	M8
PC	M8	M8	-

Connection	Cross-section mm ²	Length mm	Packs of	Model No.
M8 – M8	4	170	5 pc(s).	2564.000
M8 – M8	16	170	5 pc(s).	2565.000
M8 – M8	25	170	5 pc(s).	2566.000
M6 – M6	10	200	5 pc(s).	2565.100
M8 – M8	4	300	5 pc(s).	2567.000
M6 – M8	10	300	5 pc(s).	2565.110
M8 – M8	10	300	5 pc(s).	2565.120
M8 – M8	16	300	5 pc(s).	2568.000
M8 – M8	25	300	5 pc(s).	2569.000
M6 – M6	10	350	5 pc(s).	2565.050



! **Also required:**

- Assembly parts for earth straps, see page 1033

Earthing braid

Tin-plated copper, in various lengths and cross-sections with press-fitted contact rings. Earthing braids counteract the current displacement effect at high frequencies, whilst at the same time offering highly flexible connection opportunities.

Approvals:

- UR, cUR

For	Cross-section mm ²	Length mm	Packs of	Model No.
M6	10	200	10 pc(s).	2412.210
M8	16	200	10 pc(s).	2412.216
M8	25	200	10 pc(s).	2412.225
M6	10	300	10 pc(s).	2412.310
M8	16	300	10 pc(s).	2412.316
M8	25	300	10 pc(s).	2412.325



! **Also required:**

- Assembly parts for earth straps, see page 1033

Assembly parts

for earth straps

For fastening the earth straps and earthing braids to:

- Horizontal and vertical enclosure sections
- Punched section with mounting flange, 23 x 64 mm
- Punched section without mounting flanges, 23 x 64 mm
- Gland plates

Size	Packs of	Model No.
M6	10 pc(s).	2570.000
M8	10 pc(s).	2559.000

! **Also required:**

- For mounting on horizontal and vertical enclosure sections: Cage nuts, see page 1002



Contact washer

Serrated contact washers facilitate the secure connection of PE conductors, so there is no need to manually strip paint in the connection area.

Size	Packs of	Model No.
M5	100 pc(s).	2343.000
M6	100 pc(s).	2334.000
M8	100 pc(s).	2335.000



Interior installation

Earthing

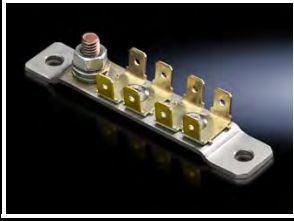

Earthing plate

- For installation in
- Comfort Panel
 - Optipanel
 - VX
 - VX SE
 - PC

One earthing cable can be screw-fastened to the threaded bolt and connected to up to 8 components with earth straps via 6.3 mm flat-pin connectors.

Packs of	Model No.
1 pc(s).	2570.500

Supply includes:

- Assembly parts

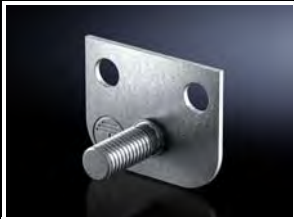

Central earthing point

- For connecting
- Earth straps
 - Earthing braids
- to the vertical and horizontal enclosure sections. The connection bracket is connected to the enclosure frame with 2 screws and is securely contacted. Earth connection is via the threaded bolt M8 x 20 mm.

Material:

- Sheet steel

Surface finish:

- Zinc-plated

Packs of	Model No.
1 pc(s).	7829.200

Supply includes:

- 1 connection bracket
- 2 assembly screws for mounting on the enclosure section
- 2 serrated washers
- 1 nut M8
- 1 contact washer M8
- 1 washer

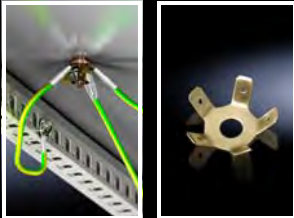

Potential equalisation star

for 8 mm earthing bolt

The earthing connector is used for simple potential equalisation on an 8 mm earthing bolt, or in conjunction with central earthing point 7829.200. Up to five flat-pin connectors (6.3 mm) may be contacted on one earthing point.

Packs of	Model No.
10 pc(s).	7548.210

Supply includes:

- 10 earthing connectors
- Assembly parts

Potential equalisation kit

for VX IT

Central earthing point on the enclosure frame for simple connection of the enclosure to the earthing/potential equalisation network (rack bonding conductor (RBC) connection point).

Application:

- To create seamless central potential equalisation between all installed components and/or to ensure functional earthing to EN 50 310

Functional principle:

- Contact between all enclosure panels and the enclosure frame as central earthing point plus contact with all installed components to the same potential, via a conductive attachment or separate earth strap

Supply includes:

- 7 earth straps (4 mm²), for doors and optional side panels
- Central earthing point
- Assembly parts

Packs of	Model No.
1 pc(s).	5302.027

Note:

- If a risk assessment of the ultimate application has been carried out by a qualified electrician and no extended risk potential has been identified, no protective earthing measures are required

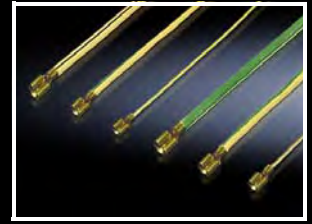

Earthing extension kits

To supplement the existing earthing or potential equalisation sets for integrating additional installation components into the potential equalisation system. For targeted contact of installation components with the enclosure frame. The earth conductors are pre-assembled with connectors ready for connection and cut to the correct length.

Application:

- For extending the existing potential equalisation set

Packs of	Model No.
1 pc(s).	7829.150

Supply includes:

- 8 earth straps, UL style 1015 AWG 12
- Connection accessories

Approvals:

- UL



Potential equalisation kit, Plus version

for VX IT

For improved EMC.

Benefits:

- All enclosure elements are connected via earthing braids to a central, vertical potential equalisation rail (rack bonding busbar, RBB) via the frame structure as central consolidation point

Application:

- Ensures continuous potential equalisation and/or functional earthing
- Improved protection from high-frequency interfering radiation to EN 50 310

Functional principle:

- Potential equalisation rail for central potential equalisation of all installed equipment on the enclosure and components connected to the potential equalisation

Supply includes:

- 6 earthing braids (M8), 10 mm², for sheet steel doors, side panels, potential equalisation rail
- Potential equalisation rail, length 1545 mm, for height 1800 – 2000 mm
- Assembly parts

Packs of	Model No.
1 pc(s).	5302.028

Note:

- If a risk assessment of the ultimate application has been carried out by a qualified electrician and no extended risk potential has been identified, no protective earthing measures are required
- To ensure an increased shielding effect of the enclosure, use of an enclosure with an all-round sealed body is advisable, similar to that used in IP enclosure variants with a solid sheet steel door at the front (as configuration only), solid roof plate, screw-fastened side panels and solid base



Assembly instruction:

- The specific connection cables between the installed equipment and the potential equalisation rail must be supplied by the user



Accessories:

- Conductor connection clamp, see page 349

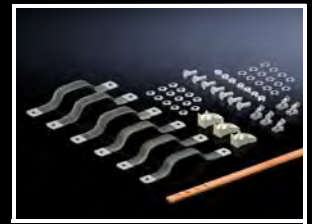

Interior installation

Earthing

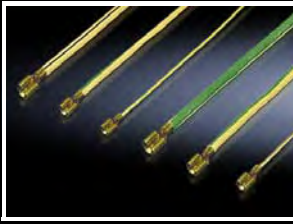

Complete earthing kit

for TE

For system-compatible earthing of all housing parts on the housing frame. The earth conductors are pre-assembled with connectors ready for connection and cut to the correct length.

Supply includes:

- 4 earth straps, 300 mm
- 4 earth straps, 350 mm
- Assembly parts

Packs of	Model No.
1 pc(s).	7000.675

Note:

- If a risk assessment of the ultimate application has been carried out by a qualified electrician and no extended risk potential has been identified, no protective earthing measures are required



PE busbar

699 mm long PE busbar with 42 pre-fitted screws, including terminal clamps up to 6 mm² (fine wire conductors), 10 mm² (single wire or multi-wire conductors) and main terminal clamp up to 35 mm².

Packs of	Model No.
1 pc(s).	2364.000



Accessories:

- Cable retainer, see page 1002

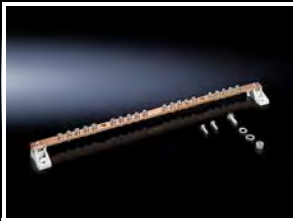

Earth rail, horizontal

for VX, VX SE, VX IT

Supply includes:

- Earth rail made from E-Cu 57 to DIN EN 12 163, DIN EN 13 601, 15 x 5 mm
- 20 connection points with M5 screws
- 2 earth connections 25 mm²
- 2 isolators
- Assembly parts

For enclosure width mm	Width mm	Height mm	Length mm	Packs of	Model No.
600, 800	15	5	450	1 pc(s).	7113.000



Earth rail, vertical

for VX, VX IT

Easily fitted to the 25 mm DIN pitch pattern of distributors or to the 482.6 mm (19") mounting angles. The supplied earth conductors facilitate star earthing of the cable clamp straps in the patch panels. The earth terminals are fully adjustable. Current carrying capacity of rail approx. 200 A.

Supply includes:

- Earth rail made from E-Cu 57 to DIN EN 12 163, DIN EN 13 601, 15 x 5 mm
- 16 push-in conductor connection clamps, 1.5 – 16 mm²
- 15 earthing leads 6 mm², L = 500 mm
- Assembly parts

For enclosure height mm	Length mm	Packs of	Model No.
800	545	1 pc(s).	7541.000
1000	745	1 pc(s).	7542.000
1200	945	1 pc(s).	7543.000
1400	1145	1 pc(s).	7544.000
1600	1345	1 pc(s).	7545.000
1800	1545	1 pc(s).	7546.000
2000	1745	1 pc(s).	7547.000
2200	1945	1 pc(s).	7548.000

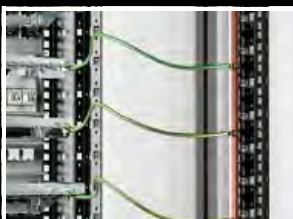

Extension kit

for earth rail, vertical

For system-compatible expansion of the star earthing on the vertical potential equalisation rail.

Supply includes:

- Earthing leads 6 mm², L = 500 mm
- Preassembled, with ring terminal and wire end ferrule
- Push-in conductor connection clamps 1.5 – 16 mm²
- Assembly parts

Packs of	Model No.
10 pc(s).	7549.000



ESD connection point

Dangerously high potential differences can occur during maintenance or conversion work on the enclosure. To protect sensitive electronic components, this standardised connection point (push-button) provides potential equalisation between service engineer and enclosure. The connection point is directly conductively connected to the enclosure frame via two screws.

Packs of	Model No.
1 pc(s).	7752.950

Material:

- Sheet steel

Surface finish:

- Zinc-plated

Supply includes:

- Assembly parts

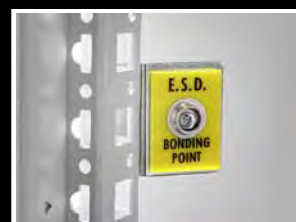
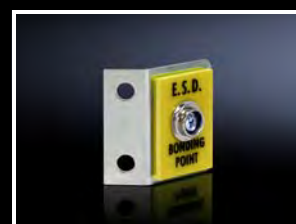

Interior installation

Earthing

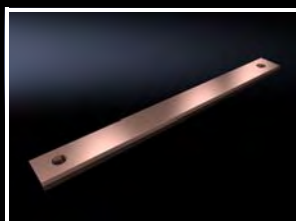

PE/PEN busbar E-Cu

for VX

With integral punchings.

Material:

- E-Cu

Standards:

- DIN EN 13601



Accessories:

- PE/PEN angle bracket, see page 1038
- PE/PEN baying bracket E-Cu, see page 1039

Dimension 30 x 5 mm

For enclosure width mm	Length mm	Hole Ø mm	Packs of	Model No.
400	300	11.5	2 pc(s).	9686.524
600	500	11.5	2 pc(s).	9686.526
800	700	11.5	2 pc(s).	9686.528
1000	900	11.5	2 pc(s).	9686.520
1200	1100	11.5	2 pc(s).	9686.522

Dimension 30 x 10 mm

For enclosure width mm	Length mm	Hole Ø mm	Packs of	Model No.
400	300	11.5	2 pc(s).	9686.534
600	500	11.5	2 pc(s).	9686.536
800	700	11.5	2 pc(s).	9686.538
1000	900	11.5	2 pc(s).	9686.530
1200	1100	11.5	2 pc(s).	9686.532

Dimension 40 x 10 mm

For enclosure width mm	Length mm	Hole Ø mm	Packs of	Model No.
400	300	11.5	2 pc(s).	9686.544
600	500	11.5	2 pc(s).	9686.546
800	700	11.5	2 pc(s).	9686.548
1000	900	11.5	2 pc(s).	9686.540
1200	1100	11.5	2 pc(s).	9686.542

Dimension 80 x 10 mm

For enclosure width mm	Length mm	Hole Ø mm	Packs of	Model No.
400	300	11.5	2 pc(s).	9686.584
600	500	11.5	2 pc(s).	9686.586
800	700	11.5	2 pc(s).	9686.588
1000	900	11.5	2 pc(s).	9686.580
1200	1100	11.5	2 pc(s).	9686.582



PE/PEN angle bracket

for VX

For attaching the PE/PEN busbar to the enclosure section.

Material:

- Sheet steel, 3.0 mm

Supply includes:

- Assembly parts

For busbar mm	Packs of	Model No.
30 x 5	2 pc(s).	9686.350
30 x 10		
40 x 10		
80 x 10		

PE/PEN baying bracket E-Cu for VX

For connecting the busbars from enclosure to enclosure.

Material:

- E-Cu

Standards:

- DIN EN 13601

Size mm	Length mm	Packs of	Model No.
30 x 5	180	2 pc(s).	9686.529
30 x 10	180	2 pc(s).	9686.539
40 x 10	180	2 pc(s).	9686.549
80 x 10	180	2 pc(s).	9686.589

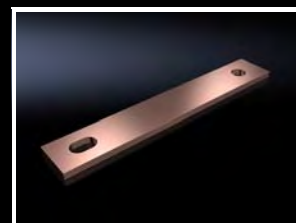

Busbar support

N conductor

For assembling 1-pole neutral or PEN conductors. The busbar holder is mounted onto the enclosure section.

Material:

- Polyamide
- Fire protection corresponding to UL 94-HB

Colour:

- Similar to RAL 7016

Supply includes:

- Assembly parts

For busbar mm	Packs of	Model No.
50 x 10	2 pc(s).	9686.300



Also required:

- Busbars E-Cu, see page 342.



Assembly instruction:

- For the installation of max. 4 busbars (sub-conductors) per phase



Accessories:

- Longitudinal connector E-Cu, see page 397



Inserted screw nut M12

Self-holding nuts with knurled ring for busbars E-Cu.

Hole diameter: 14.5 mm

Packs of	Model No.
30 pc(s).	3591.060



Power supply

Socket strips



Socket strips

in an aluminium duct

The socket strips are available in various lengths with different functional elements. Special attention has been devoted to practical, universal fastening: Variable attachment facilities have been created with an angle bracket which may be inserted in four positions. Hence, for example, the 482 mm long socket strip may optionally be mounted on 482.6 mm (19") mounting angles, the 482.6 mm (19") mounting frame, on the enclosure frame, or in the rear section of the wall-mounted distributor. Without additional mounting accessories, the socket strip may be inserted into all sections with a 25 mm hole pattern. This makes selection much easier, as well as providing additional flexibility and saving on warehousing. Provision has also been made for cable routing of the infeed, and when mounting in the 482.6 mm (19") section there is adequate space to route the infeed between the socket strip and the profile rail without kinks.

The arrangement of the IEC 320 sockets at a 45° angle allows unrestricted use of angular connectors.

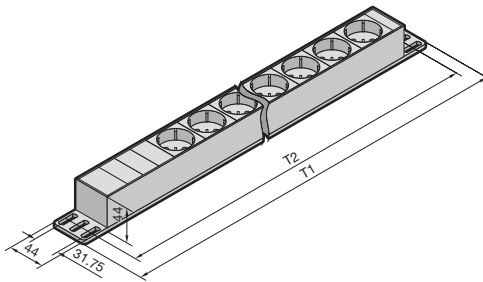

Technical specifications:

Earthing-pin socket strips

- Connector type F (CEE 7/3)
- Rated operating voltage: 250 V
- Connection cable: 2 m long H05VV-F3G1.5 without connector, [5] with connector

Belgium/France (UTE) socket strips

- Connector type E (CEE 7/5)
- Rated operating voltage: 250 V
- Connection cable: 2 m long H05VV-F3G1.5 with wire end ferrules

Equipment connector strips (IEC 60 320-1/C13) socket strips

- Rated operating voltage: 250 V
- Input: With C14 connector (H05VV-F3G1.0) or without connector (H05VV-F3G1.5), depending on the variant

Material:

- Aluminium section: Natural anodised
- Socket inserts: Polycarbonate

Supply includes:

- Socket strip
- 2 mounting brackets
- Assembly parts

Standards:

- Earthing-pin socket: DIN 49 440
- IEC 320 socket: EN 60 320-2-2
- Overvoltage protection: DIN EN 61 643-11 (VDE 0675 Part 6-11)

Approvals:

- CE
- RoHS

Note:

- Depending on the application, we recommend use of a charging current reserve to prevent incorrect activation due to starting-current spikes

Earthing-pin connector type

Version	Rated current A	Con-nection	No. of sockets	Attachment			Length (T1) mm	Mount- ing dimen- sion (T2) mm ¹⁾	Packs of	Model No.
				Frame	Wall- mounted distribu- tor, hori- zontal	482.6 mm (19") level				
[1] Without rocker switch	16	Cable	3	■	-	-	262.6	232.5	1 pc(s).	7240.110
			7	■	■	■	482.6	452.5	1 pc(s).	7240.210
			12	■	-	-	658.6	628.5	1 pc(s).	7240.310
[2] With rocker switch	16	Cable	3	■	-	-	306.6	276.5	1 pc(s).	7240.120
			7	■	■	■	482.6	452.5	1 pc(s).	7240.220
[3] Overvoltage protection, type 3 and interference suppressor filter	16	Cable	5	■	■	■	482.6	452.5	1 pc(s).	7240.230
			9	■	-	-	658.6	628.5	1 pc(s).	7240.330
[4] Circuit-breaker, type B, 16 A, 2-pole	16	Cable	5	■	■	■	482.6	452.5	1 pc(s).	7240.240
[5] UPS strip, connection cable with 10 A IEC 320 connector, type E, with G fuse, 10 A	10	C14	7	■	■	■	482.6	452.5	1 pc(s).	7240.260
[6] FI switch, 0.03 A, 2-pole, type A	16	Cable	5	■	■	■	482.6	452.5	1 pc(s).	7240.280
UTE sockets, type E with earthing pin (Belgium/France)	16	Cable	7	■	■	■	482.6	452.5	1 pc(s).	7240.510

¹⁾ Variable attachment distance within a range of 25 mm, the distance given is hole centre - hole centre of mounting bracket

C13 connector type

Version	Rated current A	Con-nection	No. of sockets	Attachment			Length (T1) mm	Mount- ing dimen- sion (T2) mm ¹⁾	Packs of	Model No.
				Frame	Wall- mounted distribu- tor, hori- zontal	482.6 mm (19") level				
For IEC 320 connectors	16	Cable	12	■	■	■	482.6	452.5	1 pc(s).	7240.200
For IEC 320 connectors with IEC 320 input	10	C14	9	■	■	■	482.6	452.5	1 pc(s).	7240.201

¹⁾ Variable attachment distance within a range of 25 mm, the distance given is hole centre - hole centre of mounting bracket

Socket strip

Earthing-pin, with plastic housing

Robust 8-way earthing-pin socket strip in a plastic housing. The strip may be mounted vertically on the enclosure frame or in the 482.6 mm (19") section. 2.5 U are required for 482.6 mm (19") installation. The earthing-pin inserts are arranged at an angle of 45° so that angular connectors are also easily used. The connection cable is attached to a terminal connection (behind a removable cover) in the socket strip. The socket strip has a terminal for an external earthing connection.

Technical specifications:

- Connector type F (CEE 7/3)
- Rated operating voltage: 230 V
- Rated current: 16 A
- Connection cable: Type H05WW-F3G1.5 (black) with wire end ferrules
- Length: 2 m
- Dimensions:
W x H x D: 483 x 74 x 45 mm

Socket strip	Packs of	Model No.
8-way, earthing-pin	1 pc(s).	7000.630

Supply includes:

- Socket strip
- Assembly parts

Material:

- Plastic (grey/black)

Approvals:

- CE
- RoHS



Socket strip

with power measurement

The socket strip 7x CEE 7/3 (type F - earthing-pin socket) with integrated display measures the power consumed by all connected equipment.

The 482.6 mm (19") long socket strip may optionally be mounted on the 482.6 mm (19") mounting angles, on the enclosure frame or in the rear section of wall-mounted distributors. The installation bracket may be mounted in four different positions for variable mounting. Without additional mounting accessories, the socket strip may be inserted into all sections with a 25 mm hole pattern.

Installation options:

- Components with a 25 mm pitch pattern
- 482.6 mm (19") level
- Enclosure frame
- IT rack, at the rear, horizontal (adequate width provided)

Benefits:

- Measurement accuracy of $\pm 5\%$

Functions:

- Measurement of current, voltage, frequency, active power, active energy and phase shift

Material:

- Aluminium section: Natural anodised
- Socket inserts: Polycarbonate

Colour:

- Socket: RAL 7035

Supply includes:

- Socket strip
- 2 mounting brackets
- 3 m connection cable with wire end ferrules
- Assembly parts



Version	No. of sockets	Socket/jack (type)	Height mm	Length mm	Depth mm	Mounting dimension mm	Rated voltage	Phase current A	Packs of	Model No.
With display	7	D, earthing-pin (type F, CEE 7/3)	45	482.6	50	464.1	230 V AC	16	1 pc(s).	7240.301

Power supply

Socket strips



Junction box

with multi-functional bracket

The angle bracket can be installed in all network enclosures in a system-compatible design. The junction box serves as a transfer point for the power supply to all equipment (fans, lights and socket strips). As well as being used as a junction box or interchange point, the bracket can also accommodate the enclosure internal thermostat 3110.000 or the hygrostat 3118.000, thanks to its integral holes.

Material:

- Sheet steel

Colour:

- RAL 7035

Supply includes:

- Junction box
- Bracket
- 6 m connection cable 3 x 1.5 mm² (flexible)

Packs of	Model No.
1 pc(s).	7280.035



Socket

- For mounting on support rails TS 35/7.5 and TS 35/15 to EN 60 715
- Uniform screw terminals from one side
- Enclosure width: 45 mm

Technical specifications:

- Rated voltage: 250 V AC
- Rated current: 16 A

Material:

- Polyamide

Colour:

- Grey

Approvals:

- VDE

Version	Packs of	Model No.
Earthing-pin/CEE 7/3	2 pc(s).	2506.120



Service socket

for enclosure frame attachment/16 A

Integration of a service socket within a separate supply circuit, independently of the IT network and UPS. Simple installation via an angle bracket for attaching to the enclosure frame.

Type: Earthing contact/CEE 7/3

Material:

- Angle bracket: Sheet steel
- Socket: Plastic

Surface finish:

- Angle bracket: Zinc-plated

Supply includes:

- Service socket
- Angle bracket
- Damp-proof socket (IP 44)
- Assembly parts

Packs of	Model No.
1 pc(s).	7280.100



Energy-Box, 3 U, 482.6 mm (19")

Technical specifications:

- Depth-adjustable top hat rail for installed equipment to DIN 43 880, sizes 1 – 3 (e.g. to accommodate built-in sockets, circuit-breakers etc.)
- Cable clamping at the rear, one N and one PE rail on an insulated plinth.
- Plastic hood including extension cover (UL 94-V0)
- Maximum accommodation capacity of 22 HP (22 x 18 mm = 396 mm).
- Enclosure height: 3 U
- Enclosure depth: 155 mm
- Overall installation depth with C rail: 155 mm
- Dimensions: W x H x D: 483 x 132.5 x 155 mm

Colour:

- RAL 7035

Supply includes:

- Energy-Box with fitted N and PE rails and brush strip
- 4 connection clamps, 35 mm²
- 18 connection clamps, 16 mm²
- 2 blanking covers
- 12 clips for cable strain relief
- Identification strips, self-adhesive

U	Packs of	Model No.
3	1 pc(s).	7480.035

Photo shows a configuration example with equipment not included in the scope of supply



Energy-Box, 3 U, 482.6 mm (19")

Pull-out

Technical specifications:

- Depth-adjustable top hat rail for snap-in attachment of installed equipment to DIN 43 880 in sizes 1 – 3 (e.g. to accommodate built-in sockets, circuit-breakers etc.) or entire installation assemblies.
- Cable clamping at rear
- Two power distribution rails with connection clamps on insulated base/plinth
- Plastic hood including extension cover
- Maximum accommodation capacity of 22 HP (22 x 18 mm = 396 mm).
- Enclosure height: 3 U
- Enclosure depth: 223 mm
- Maximum extension: 220 mm
- Dimensions: W x H x D: 483.5 x 132 x 223 mm

Colour:

- RAL 7035

Supply includes:

- Energy-Box with fitted N and PE rails and brush strip
- 4 connection clamps, 35 mm²
- 18 connection clamps, 16 mm²
- 2 blanking covers
- 12 clips for cable strain relief
- Identification strips, self-adhesive

U	Packs of	Model No.
3	1 pc(s).	7480.300

Photo shows a configuration example with equipment not included in the scope of supply



Cable management

Cable entry



Cable entry plate

for VX, VX SE

- Cable entry grommet
 - Connector grommet
- instead of segments from the standard divided gland plates

Material:

- Sheet steel

Surface finish:

- Zinc-plated

Protection category IP to IEC 60 529:

- IP 55 in conjunction with cable entry grommets or connector grommets

Supply includes:

- Assembly parts

Enclosure width mm	Cut-outs per plate	Packs of	Model No.
600	6	2 pc(s).	8619.800
800	8	2 pc(s).	8619.801
1000	5	4 pc(s).	8619.802
1200	6	4 pc(s).	8619.803



Also required:

- Cable entry grommet, see page 1044 or
- Connector grommet, see page 1044

Three examples from a wide range of possibilities

The diagrams show three examples for positioning cable entry plates instead of segments from the three-piece gland plates supplied as standard. In this way, they can be positioned to fit the mounting plate. Thanks to the enclosure symmetry, where dimensions permit, cable entry plates may also be inserted in the enclosure depth, right and left, analogous to the gland plates.

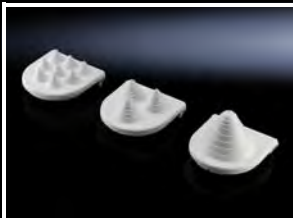
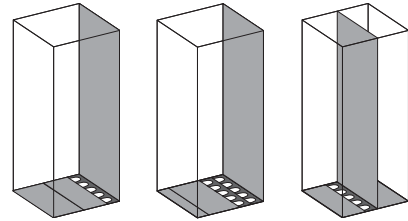

Cable entry grommet

In conjunction with the cable entry plate, supports simple, fast sealing of cables inserted into the base area of enclosures.

Material:

- Body: Polypropylene
- Cover: Thermoplastic elastomer

Protection category IP to IEC 60 529:

- IP 55 if installed correctly

Cables per grommet	Max. Ø mm	Packs of	Model No.
8	13	25 pc(s).	4316.000
3	21	25 pc(s).	4317.000
1	47	25 pc(s).	4318.000

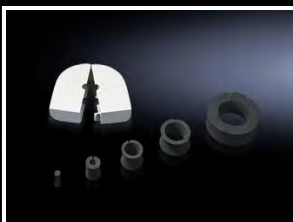

Connector grommets

Suitable for cable diameters from 8 to 36 mm.

Material:

- Outer cover: Polypropylene covered with thermoplastic elastomer
- Seal: Cellular rubber

Protection category IP to IEC 60 529:

- IP 55 if installed correctly

Packs of	Model No.
10 pc(s).	4311.000

Cable management

Cable entry

Section for cable entry, centre for VX, VX SE

For top-mounting on gland plates.

Material:

- Extruded aluminium section
- Seal: PU foam
- Cross-section: 30 x 25 mm

Protection category IP to IEC 60 529:

- IP 55 if installed correctly

Supply includes:

- Plug-in sections, incl. foam rubber clamp strips

Note:

- You will need two pieces per cable entry point.
- From an enclosure width of 1000 mm, the base assembly is divided into two sections in the width. Two cable entry points (left/right) may be used.

For enclosure width mm	Packs of	Model No.
600	2 pc(s).	8618.800
800	2 pc(s).	8618.801
1000	4 pc(s).	8618.802
1200	4 pc(s).	8618.803
1600	4 pc(s).	8618.804

+ **Accessories:**

- Cable clamp rail, see page 1059

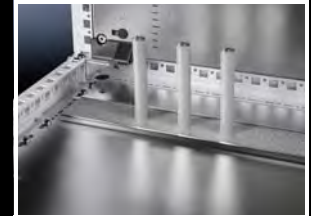
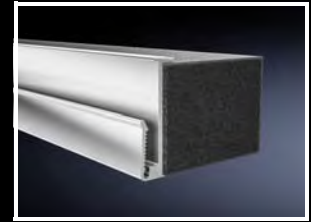

Section for cable entry, rear for VX, VX SE

For top-mounting on the gland plate and enclosure frame.

Material:

- Extruded aluminium section
- Seal: PU foam
- Cross-section: 30 x 25 mm

Protection category IP to IEC 60 529:

- IP 55 if installed correctly

Supply includes:

- Plug-in sections, incl. foam rubber clamp strips

Note:

- You will need two pieces per cable entry point.
- From an enclosure width of 1000 mm, the base assembly is divided into two sections in the width. Two cable entry points (left/right) may be used.

For enclosure width mm	Packs of	Model No.
600	2 pc(s).	8618.810
800	2 pc(s).	8618.811
1000	4 pc(s).	8618.812
1200	4 pc(s).	8618.813
1600	4 pc(s).	8618.814

+ **Accessories:**

- Cable clamp rail, see page 1059



Foam rubber cable clamp strip

For sealing the cable entry between the gland plates. Particularly suitable for identical cable cross-sections.

Material:

- PU foam
- Cross-section: 30 x 30 mm

Protection category IP to IEC 60 529:

- IP 55 if installed correctly

Packs of	Model No.
3 m	2573.000

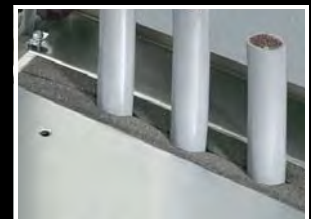

Cable management

Cable entry

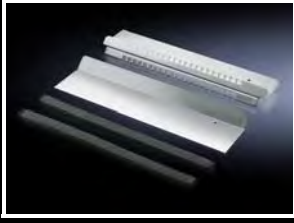

EMC gland plates

see page 1029



Connector gland

for connector cut-outs (24-pole)

For inserting 2 pre-assembled cables through the connector cut-out, without dismantling the cable connector.

Cable diameters: 8 – 36 mm

Material:

- Enclosure: Plastic
- Clamps: Sheet steel

Surface finish:

- Clamps: Zinc-plated

Supply includes:

- 1 pc(s). =
2 half-shells, including seals, with fastening clamp

Packs of	Model No.
1 pc(s).	2400.000



Cable gland

for IW worktops

To fit drilled holes \varnothing 60 mm. For the entry of cables with pre-assembled connectors, the rotating flap and cover are easily removed.

Material:

- Plastic

Colour:

- RAL 7035

Packs of	Model No.
1 pc(s).	6902.770

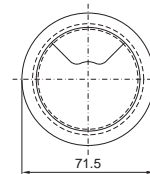
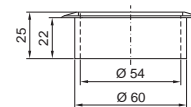

Cable management

Cable entry

Edge protection

For covering sharp edges of cut-outs. Provides protection of injuries and prevents damage to inserted cables. The edge protector is suitable for material thicknesses of approx. 1.0 – 2.0 mm, and may be cut to length individually.

Material:

– Plastic PVC

Colour:

– Black

Packs of	Model No.
10 m	7072.100



Connector gland, small

For pre-assembled cables with connectors. For use with material thickness of up to 4 mm. Strain relief of the pre-assembled cables can be achieved with cable ties.

Material:

– Plastic

Colour:

– RAL 9005

Protection category IP to IEC 60 529:

– IP 65 if installed correctly

Supply includes:

– Assembly parts

To fit	Packs of	Model No.
2 cables Ø 6 – 8 mm	1 pc(s).	2400.300
3 cables Ø 4 – 6 mm	5 pc(s).	2400.500

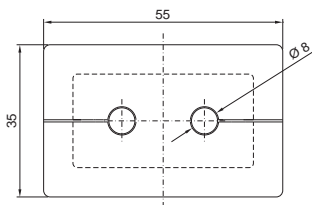

2400.300

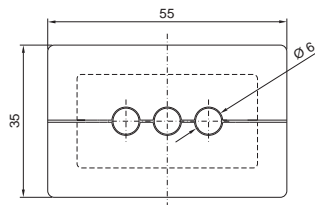

2400.500

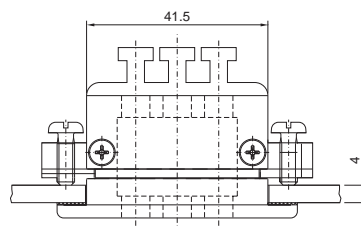
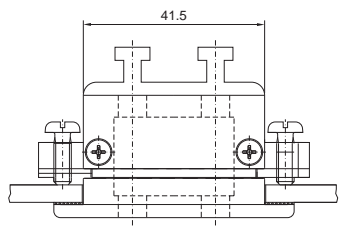
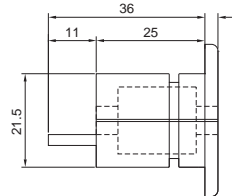

Mounting cut-out

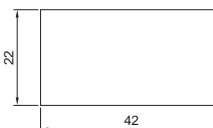

Cable management

Cable entry

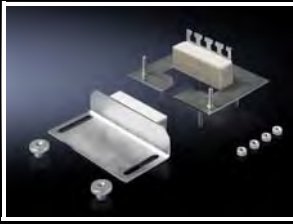

Cable gland module

for support arm connection Ø 130 mm

Use of the mounting cut-out for support arm connection Ø 130 mm, round, with enclosures mounted on the wall, for sealed cable entry. May also be mounted retrospectively with the cables already inserted. Fitted with T-heads for cable clamping. Particularly well-suited to cables with identical cross-sections.

Material:

- Sheet steel

Surface finish:

- Zinc-plated

Supply includes:

- Assembly parts

Protection category IP to IEC 60 529:

- IP 55 with correct installation and cable entry

Packs of	Model No.
1 pc(s).	6052.500

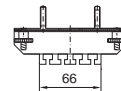
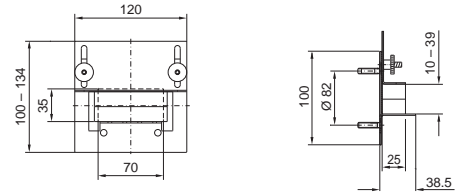

Stepped collar

for wall thicknesses from 1.5 to 4.5 mm

For cable entry, simply cut off at the required level to match the cable diameter.

Material:

- Plastic to UL 94-HB

Protection category IP to IEC 60 529:

- IP 54 with careful cable entry

For hole	Sealing range mm	Packs of	Model No.
M20	5 - 16	100 pc(s).	2899.200
M25	5 - 21	50 pc(s).	2899.250
M32	13 - 26.5	25 pc(s).	2899.320
M40	13 - 34	20 pc(s).	2899.400

Sealing frame, modular

For the universal use on all surfaces and walls, for feeding through pre-fabricated cables with connectors. Can also be mounted onto 24-pole or 16-pole connector cut-outs.

Material:

- Plastic

Colour:

- Black

Protection category IP to IEC 60 529:

- IP 66

Supply includes:

- Sealing frame
- Locking frame

Number of small seal inserts	For cut-out mm	Model No.
10	113.5 x 46 (24-pole)	2583.100
8	91 x 46 (16-pole)	2583.080



Also required:

- Inlay for plastic gland plate, modular and sealing frame, modular, see page 1051
- Seal inserts for cable gland plates, modular and sealing frame, modular, see page 1051

Cable management

Gland plates

Plastic gland plate, modular and sealing frame, modular

The plastic gland plate, modular and the sealing frame, modular, offer extensive flexibility with the entry of assembled and unassembled cables, with or without connectors. Depending on the cable cross-section, suitable modules are selected to retain the high protection category of IP 66 after cable entry.

The gland plate design also supports mixed use with standard cable glands and inlays with seal inserts. In this way, cables prefitted with connectors may be safely inserted into the enclosure retrospectively. Seven different gland plate sizes are available. The sealing frame design may be used on any sufficiently large surface.



Plastic gland plate, modular for AX

- 1 Rectangular cut-outs for inlays and seal inserts, see page 1051
- 2 Metric knockouts for cable glands, see page 1056
- 3 Plastic gland plates, modular, see page 1050

Sealing frame, modular for AX, KX

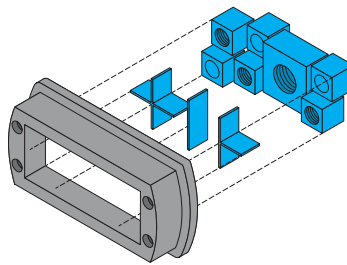
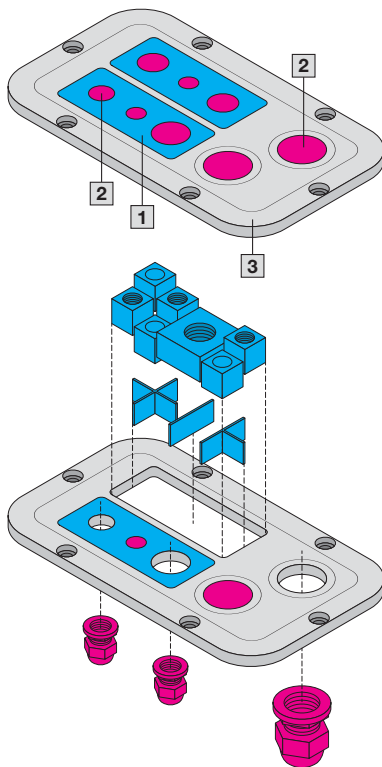

Cable management

Gland plates



Plastic gland plate, modular with metric knockouts, for AX

Simply pierce the plastic knockouts, and pull through the cable. Additional rectangular cut-outs and reinforcement frame allow the inlays and seal inserts to be installed directly.

Temperature range:

– Suitable for use from -40 °C...+80 °C

Material:

– Plastic to UL 94-V0

Colour:

– RAL 7035

Protection category IP to IEC 60 529:

– IP 66 if installed correctly

Note:

– The applicable size may be taken from the relevant product ordering page



Accessories:

- Inlay, see page 1051
- Seal inserts, see page 1051
- Cable glands, see page 1056

Model No.	2561.200	2562.200	2563.200	2564.200	2565.200	2566.200	2567.200
Packs of	1 pc(s).	1 pc(s).	1 pc(s).	1 pc(s).	1 pc(s).	1 pc(s).	1 pc(s).
Gland plate	Size 1	Size 2	Size 3	Size 4	Size 5	Size 6	Size 7
Dimensions W x D mm	256 x 149	339 x 149	447 x 149	534 x 149	301 x 221	401 x 221	436 x 221
	Diameter mm		Number of cable entries				
	M12	2	3	4	5	4	4
	M16	1	2	3	4	4	5
	M20	2	3	5	6	4	5
	M25	1	3	3	5	3	4
	M32	2	2	1	1	1	1
	M40	–	–	1	1	1	1
	M50	–	–	–	–	–	1
Rectangular cut-outs	2	3	4	6	5	6	6

Size 1

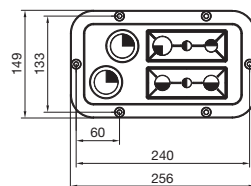

Size 2

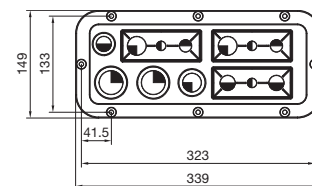

Size 3

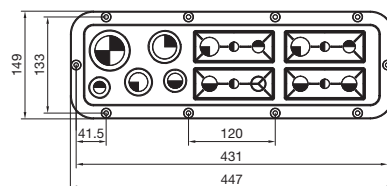

Size 5

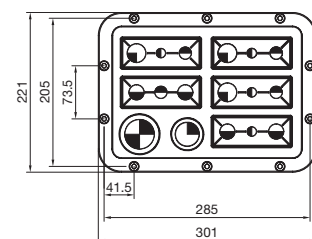

Size 4

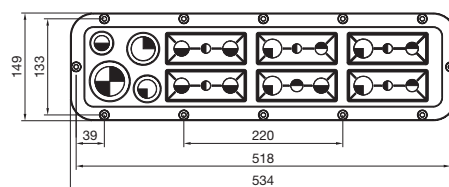

Size 6

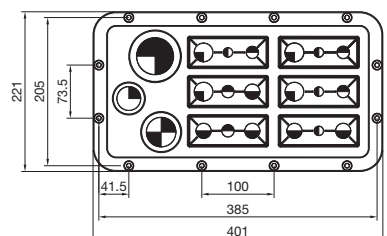

Size 7

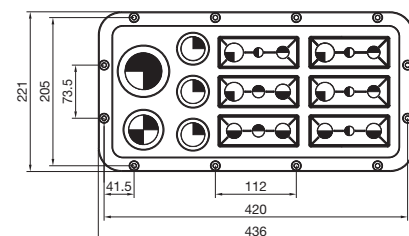

Cable management

Gland plates

Inlay

for plastic gland plate, modular and sealing frame, modular

Individual inserts to subdivide the cut-outs in the modular plastic gland plate and the modular sealing frame.

Material:

– Plastic

Colour:

– Black

Version	Packs of	Model No.
1 slot	5 pc(s).	2582.100
2 slots	5 pc(s).	2582.200
4 slots	5 pc(s).	2582.400
6 slots	5 pc(s).	2582.600

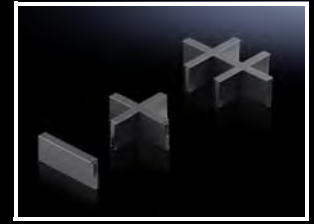

Seal inserts

for plastic gland plate, modular and sealing frame, modular

In conjunction with the inlays, the seal inserts allow individual cable entry, even with preassembled cables.

Material:

– Plastic

Colour:

– RAL 7035



Accessories:

– When using as a gland plate, modular: Locking clip for seal inserts, see page 1051

Seal inserts, small

For cable diameter	Packs of	Model No.
Solid	10 pc(s).	2580.000
3 mm	10 pc(s).	2580.003
4 mm	10 pc(s).	2580.004
5 mm	10 pc(s).	2580.005
6 mm	10 pc(s).	2580.006
7 mm	10 pc(s).	2580.007
8 mm	10 pc(s).	2580.008
9 mm	10 pc(s).	2580.009
10 mm	10 pc(s).	2580.010
11 mm	10 pc(s).	2580.011
12 mm	10 pc(s).	2580.012
13 mm	10 pc(s).	2580.013
14 mm	10 pc(s).	2580.014

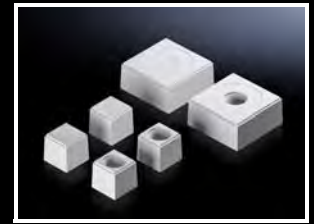

Seal inserts, large

For cable diameter	Packs of	Model No.
Solid	5 pc(s).	2580.100
15 mm	5 pc(s).	2580.115
16 mm	5 pc(s).	2580.116
17 mm	5 pc(s).	2580.117
18 mm	5 pc(s).	2580.118
19 mm	5 pc(s).	2580.119
20 mm	5 pc(s).	2580.120
21 mm	5 pc(s).	2580.121
22 mm	5 pc(s).	2580.122
23 mm	5 pc(s).	2580.123
24 mm	5 pc(s).	2580.124
25 mm	5 pc(s).	2580.125

Locking clip

for seal inserts

In conjunction with the plastic gland plate, modular, the locking clips ensure the seal inserts are held securely and cannot be accidentally pushed into the enclosure.

Material:

– Plastic

Packs of	Model No.
10 pc(s).	2583.120



Cable management

Gland plates



Plastic gland plate

with membranes, for AX

Simply pierce the plastic with a sharp object, and pull through the cable.

Material:

– Plastic to UL 94-V0

Colour:

– Similar to RAL 7035

Protection category IP to IEC 60 529:

– IP 66 if installed correctly

Note:

– The applicable size may be taken from the relevant product ordering page

Model No.	2561.300	2562.300	2563.300	2564.300	2565.300	2566.300	2567.300
Packs of	1 pc(s).	1 pc(s).	1 pc(s).	1 pc(s).	1 pc(s).	1 pc(s).	1 pc(s).
Gland plate	Size 1	Size 2	Size 3	Size 4	Size 5	Size 6	Size 7
Dimensions W x D mm	256 x 149	339 x 149	447 x 149	534 x 149	301 x 221	401 x 221	436 x 221
	Diameter mm		Number of cable entries				
●	5 – 11	15	24	36	28	30	30
◐	10 – 15	22	44	46	48	40	50
◑	15 – 25	8	6	8	8	5	8
◒	19 – 34	4	2	2	2	2	2
◓	26 – 35	–	–	4	2	–	2
◔	26 – 54	1	2	2	2	2	2
○	50 – 110	–	–	–	1	1	1

Size 1

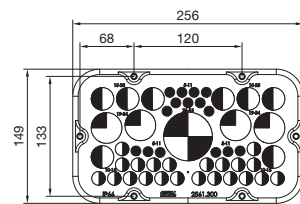

Size 2

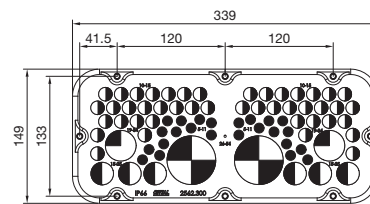

Size 3

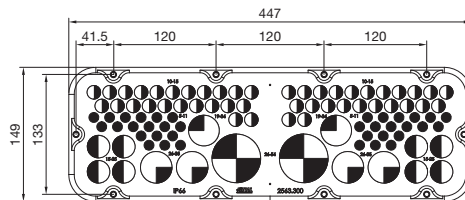

Size 5

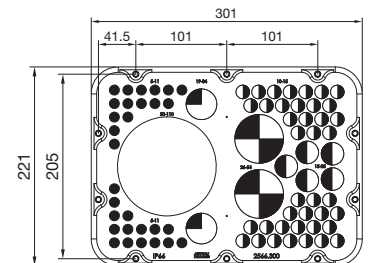

Size 4

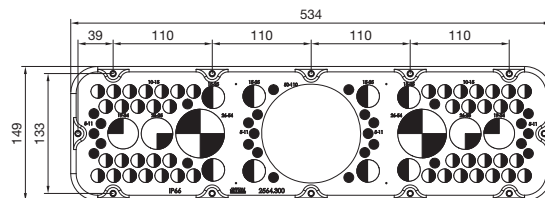

Size 6

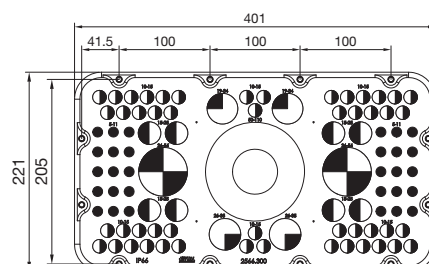

Size 7

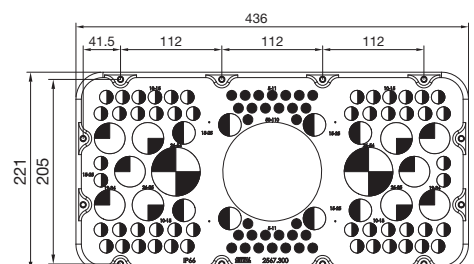

Cable management

Gland plates

Metal gland plate

with metric knockouts, for AX

Simply knock out the holes for the cable glands using a screwdriver.

Material:

– Sheet steel

Colour:

– RAL 7035

Protection category IP to IEC 60 529:

– IP 66 if installed correctly

Note:

– The applicable size may be taken from the relevant product ordering page



Accessories:

– Cable glands made from polyamide or brass, see page 1056



Model No.	2571.100	2572.100	2573.100	2574.100	2575.100	2576.100	2577.100	
Packs of	1 pc(s).	1 pc(s).	1 pc(s).	1 pc(s).	1 pc(s).	1 pc(s).	1 pc(s).	
Gland plate	Size 1	Size 2	Size 3	Size 4	Size 5	Size 6	Size 7	
Dimensions W x D mm	256 x 149	339 x 149	447 x 149	534 x 149	301 x 221	401 x 221	436 x 221	
	Diameter		Number of cable entries					
	M12	2	–	4	1	2	2	6
	M16	2	6	4	6	10	10	10
	M20	9	4	7	8	8	8	8
	M25	5	10	15	11	10	18	20
	M32	1	2	2	6	2	4	4
	M40	1	2	2	4	4	4	4

Size 1

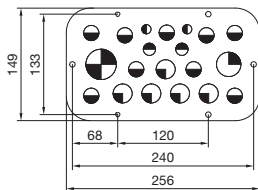

Size 2

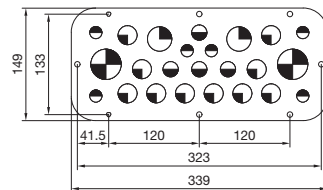

Size 3

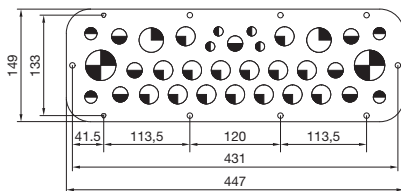

Size 4

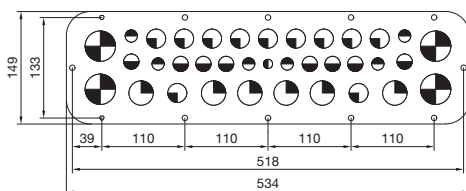

Size 5

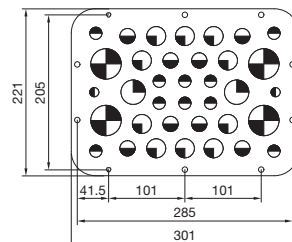

Size 6

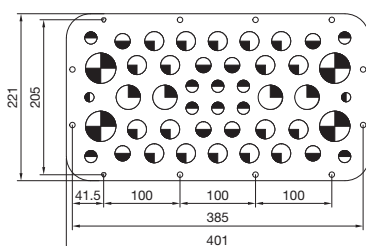

Size 7

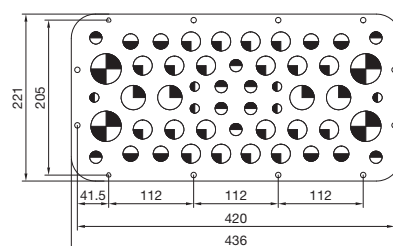

Cable management

Gland plates

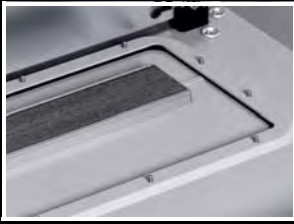

Gland plate

with foam rubber cable clamp strip, for AX

For feeding through pre-fabricated cables when the gland plate has already been fitted to the enclosure. Split gland plates can be sealed using movable plates with a foam rubber cable clamp strip.

Material:

– Gland plate: Sheet steel

Colour:

– RAL 7035

Gland plate size	Dimensions mm	Packs of	Model No.
5	301 x 221	1 pc(s).	2565.400
6	401 x 221	1 pc(s).	2566.400
7	436 x 221	1 pc(s).	2567.400



Metal gland plate

with metric knockouts, for KX

Simply knock out the holes for the cable glands using a screwdriver.

Material:

– Sheet steel

Colour:

– RAL 7035

Protection category IP to IEC 60 529:

– IP 55 if installed correctly

Diameter	Packs of	Model No.
M20	1 pc(s).	1581.200



Accessories:

– Cable glands made from polyamide or brass, see page 1056

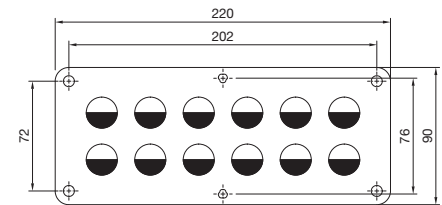

Gland plate

for metric cable glands, for EL

Folded gland plate with foamed-in seal and pre-punched, knock-out holes for metric cable glands M12, M20, M25, M32, M40.

Material:

– Sheet steel, 1.5 mm

Colour:

– RAL 7035

Protection category IP to IEC 60 529:

– IP 55

Width mm	Depth mm	Cable entry (quantity x Ø)	Packs of	Model No.
599	133.5	4 x M12 7 x M20 5 x M25 2 x M32 2 x M40	1 pc(s).	7705.235

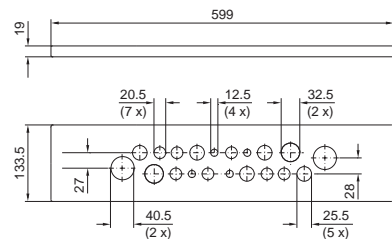

Cable management

Gland plates

Gland plate

with brush insert, for EL

Folded gland plate with foamed-in seal and plastic brush inserts for simple cable entry.

Material:

- Sheet steel, 1.5 mm

Colour:

- RAL 7035

Packs of	Model No.
1 pc(s).	7705.035

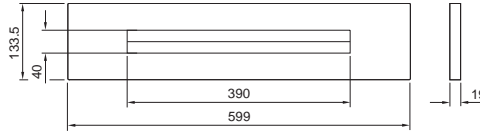

Brush strip

For individual installation of enclosure panels, gland plates and panels. Cut-outs for cable routing at any position in the side panel, rear panel, doors, roof and base plate may be finished off attractively by simply attaching the brush strip.

Material:

- Plastic, UL 94-HB

Packs of	Model No.
2 m	7072.200

Technical specifications:

- For metal thickness: 0.6 – 1.5 mm
- Bristle length: 30 mm
- Plastic sheath: 18 mm
- Snap-on surface: 10 mm
- Maximum cut-out height: 38 mm

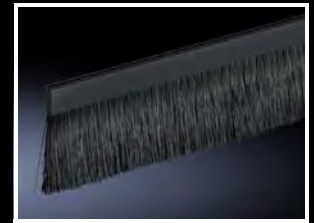

Brush strip, super-airtight

For individual installation of enclosure panels, gland plates and panels. Cut-outs for cable routing at any position in the side panel, rear panel, doors, roof and base plate.

These special brush strips may be used to create airtight entries for cable sections and conductors. The brush strips arranged in an offset configuration ensure good sealing from the routed cables even with large quantities of cables. In this way, unwanted flow losses may be reduced to a minimum.

Packs of	Model No.
2 x 1 m	7825.375

Technical specifications:

- For metal thickness: 1.5 – 2 mm
- Bristle length: 58 mm
- Plastic sheath: 14 mm
- Snap-on surface: 11.5 mm
- Cut-out width: 88 – 90 mm

Material:

- Plastic, fire protection to UL 94-HB

Supply includes:

- 1 brush strip right-hand version
- 1 brush strip left-hand version



Cable management

Cable glands



Cable gland, brass

Benefits:

- Because the gland and lock nut are sold together in a single pack, this saves additional ordering and storage
- Clamping membranes for even tightening and strain relief to protect the cables

Material:

- Brass
- Seal: CR/NBR

Surface finish:

- Nickel-plated

Protection category IP to IEC 60 529:

- IP 68 (5 bar, 30 min.)

Approvals:

- VDE, UR, cUR

Size	Packs of	Model No.
M12 x 1.5	15 pc(s).	2411.801
M16 x 1.5	15 pc(s).	2411.811
M20 x 1.5	10 pc(s).	2411.821
M25 x 1.5	10 pc(s).	2411.831
M32 x 1.5	5 pc(s).	2411.841
M40 x 1.5	4 pc(s).	2411.851
M50 x 1.5	2 pc(s).	2411.861
M63 x 1.5	1 pc(s).	2411.871

⇔ Possible alternative:

- Cable gland Hygienic Design, see page 1057



Cable gland, polyamide

Benefits:

- Because the gland and lock nut are sold together in a single pack, this saves additional ordering and storage
- Clamping membranes for even tightening and strain relief to protect the cables

Material:

- Polyamide 6
- Seal: CR

Colour:

- RAL 7035

Protection category IP to IEC 60 529:

- IP 68 (5 bar, 30 min.)

Approvals:

- VDE, UL, cUL, CSA

Size	Packs of	Model No.
M12 x 1.5	50 pc(s).	2411.601
M16 x 1.5	50 pc(s).	2411.611
M20 x 1.5	50 pc(s).	2411.621
M25 x 1.5	25 pc(s).	2411.631
M32 x 1.5	15 pc(s).	2411.641
M40 x 1.5	5 pc(s).	2411.651
M50 x 1.5	5 pc(s).	2411.661
M63 x 1.5	3 pc(s).	2411.671



EMC cable gland

see page 1030

Cable management

Cable glands

Cable gland HD

More compact design and the lock nut is included with the supply.

Applications:

- Manufacturing and packaging of foodstuffs etc.
- Clean room technology (e.g. pharmaceuticals)
- Biotechnology
- Chemical industry

Benefits:

- Smooth, solid exterior surfaces effectively prevent the depositing of harmful micro-organisms
- Much easier, therefore cheaper, cleaning compared with conventional cable glands

Material:

- Cap nut: Stainless steel 1.4305 (AISI 303)
- Seal: Compliant with FDA 21 CFR 177.2600

Protection category IP to IEC 60 529:

- IP 69
- IP X8 (5 bar, 30 min.)

Supply includes:

- HD cable gland
- Lock nut

Standard version

Size	Cable diameter mm	Packs of	Model No.
M12 x 1.5	3 – 6.5	5 pc(s).	2410.001
M16 x 1.5	5 – 10	5 pc(s).	2410.011
M20 x 1.5	6 – 12	5 pc(s).	2410.021
M25 x 1.5	12 – 17	5 pc(s).	2410.031

EMC version

Size	Cable diameter mm	Packs of	Model No.
M16 x 1.5	5 – 10	5 pc(s).	2410.111
M20 x 1.5	6 – 12	5 pc(s).	2410.121
M25 x 1.5	12 – 17	5 pc(s).	2410.131

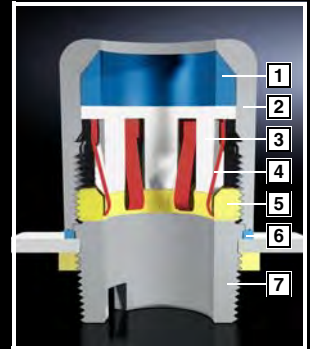
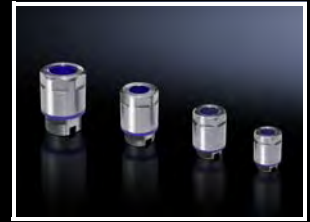

- 1 Seal
- 2 Cap nut
- 3 Gripper jaws
- 4 Shield spring (EMC version only)
- 5 Clamping ring
- 6 Enclosure seal
- 7 Base with locator for assembly tool

Why use hygienic cable glands?

Critical points with conventional solutions

- 1 Cable entry in front of seal
- 2 No minimum radii on the hexagon
- 3 External threads
- 4 Gap caused by O-ring on the enclosure surface

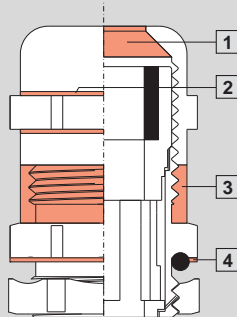

Hygienic design features

- 1 Seal directly at the cable entry
- 2 Compliance with minimum radii on the hexagon
- 3 No external threads
- 4 Flush termination between the cap nut and the enclosure

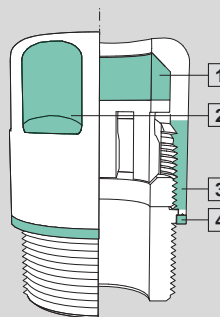

Assembly tool

for cable gland HD

For attaching HD cable glands in an internal thread or using lock nuts. This can be achieved either from the inside or from the outside using an Allen key.

Supply includes:

- 1 pc(s). = Adaptor for sizes from M12 – M25

Packs of	Model No.
1 pc(s).	2410.290

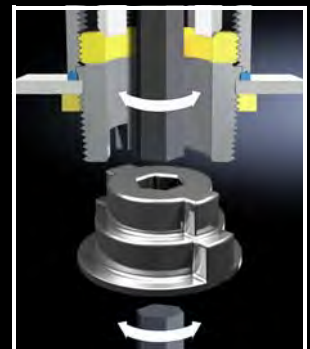

System accessories

Cable management

Cable routing inside the enclosure



Cable duct

- With special DIN punchings for direct mounting on the enclosure section or on surfaces such as mounting plates.
- If the mounting plate is installed flush with the enclosure frame at the rear (installation position ± 0 mm), the horizontally mounted cable ducts are aligned with the cable ducts mounted on the enclosure section.
- Cable duct 50 mm wide for individually sited VX25 enclosures with side panel on the vertical section, on the left and right adjacent to the mounting plate.
- Cable duct 100 mm for mounting on the vertical enclosure frame with bayed enclosures.

Technical specifications:

- Depth: 80 mm
- Length: 2000 mm, may be cut to length
- Bar width: 5.5 mm
- Slot width: 4.5 mm

Material:

- Hard PVC
- Flame-resistant, self-extinguishing
- Temperature resistant to +60 °C

Width (B) mm	Packs of	Model No.
30	24 pc(s).	8800.750
40	20 pc(s).	8800.751
50	18 pc(s).	8800.755
60	18 pc(s).	8800.752
80	12 pc(s).	8800.753
100	12 pc(s).	8800.754

Colour:

- Similar to RAL 7030



Accessories:

- Metal multi-tooth screw 5.5 x 13 mm, see page 1004
- Isolator cap, see page 1058

1 = W 50 mm

2 = W 100 mm

3 = W 30 to 100 mm

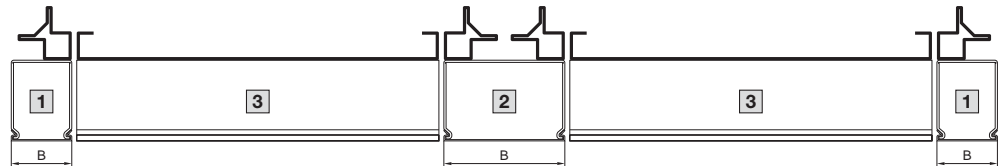

Isolator cap

for screw head

To isolate screw heads within the cable duct.

Material:

- Plastic

Packs of	Model No.
100 pc(s).	8800.770

Cable management

Cable routing inside the enclosure

Cable clamp rail

Right-angle section for VX, VX SE, PC, TP, VX base/plinth

For strain relief with cable entry. Depth-variable mounting on a 25 mm pitch pattern on the horizontal enclosure section or in the base/plinth.

Material:

– Steel

Surface finish:

– Zinc-plated

Supply includes:

– Assembly parts

Enclosure width mm	Packs of	Model No.
400	2 pc(s).	8619.400
600	2 pc(s).	8619.410
800	2 pc(s).	8619.420
1000	2 pc(s).	8619.430
1200	2 pc(s).	8619.440
1600	2 pc(s).	8619.450
1800	2 pc(s).	8619.460



Accessories:

– Base/plinth installation bracket, see page 885

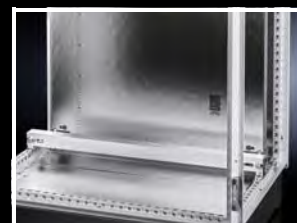

Cable clamp

for cable clamp rails

For fastening the cables to the cable clamp rails.

Material:

– Sheet steel

Surface finish:

– Zinc-plated

Supply includes:

– Plastic insert

For cable diameter mm	Packs of	Model No.
6 – 12	25 pc(s).	2350.000
12 – 16	25 pc(s).	2351.000
14 – 18	25 pc(s).	2352.000
18 – 22	25 pc(s).	2353.000
22 – 26	25 pc(s).	2354.000
26 – 30	25 pc(s).	2355.000
30 – 34	25 pc(s).	2356.000
34 – 38	25 pc(s).	2357.000
38 – 42	25 pc(s).	2358.000
42 – 46	25 pc(s).	2359.000
46 – 50	25 pc(s).	2360.000



Possible alternative:

– Rail for EMC shielding bracket and strain relief, see page 1029



Cable clamp rail

C rail, for mounting plates for VX, VX SE, TP

For strain relief with cable entry. The length of the cable clamp rail is tailored to the width of the mounting plate. The mounting bracket included with the supply supports three different installation situations on the mounting plate:

- 1 Straight, at a distance of 23 mm from the mounting plate
- 2 Straight, at a distance of 10 mm from the mounting plate
- 3 Tilted towards the mounting plate

Material:

– Sheet steel

Surface finish:

– Zinc-plated

Supply includes:

– Two mounting brackets and assembly screws

For enclosure width mm	Length mm	Packs of	Model No.
600	499	1 pc(s).	5001.080
800	699	1 pc(s).	5001.081
1000	899	1 pc(s).	5001.082
1200	1099	1 pc(s).	5001.083



Accessories:

– Cable clamp for C rails, see page 1060

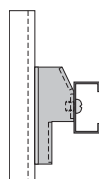

1

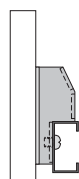

2

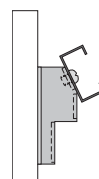

3



Cable management

Cable routing inside the enclosure



Cable clamping bracket

For installation in command panels with mounting cut-out □ 120 x 65 mm and Ø 130 mm. Cable clamping optionally via:

- Cable clamps
 - or
 - Cable ties 2597.000
 - Standard commercially available cable ties
- Bracket height = 25 mm with fitted C rail 40 mm

Material:

- Sheet steel

Surface finish:

- Zinc-plated

Supply includes:

- C rail and assembly screws

Packs of	Model No.
1 pc(s).	6052.000

+ Accessories:

- Cable clamp, see page 1060
- Cable ties, see page 1061

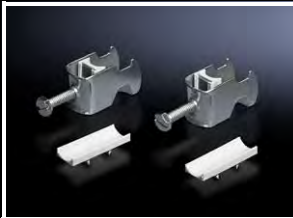

Cable clamp

for C rail, combination rail

For attaching cables to the C rail.

Material:

- Sheet steel

Surface finish:

- Zinc-plated

Supply includes:

- Plastic insert

For cable diameter mm	Packs of	Model No.
6 – 14	25 pc(s).	7077.000
12 – 18	25 pc(s).	7078.000
18 – 22	25 pc(s).	7097.000
22 – 26	25 pc(s).	7097.220
26 – 30	25 pc(s).	7097.260
30 – 34	25 pc(s).	7097.300
34 – 38	25 pc(s).	7097.340
38 – 42	25 pc(s).	7098.000
42 – 56	25 pc(s).	7098.100
56 – 64	25 pc(s).	7099.000

+ Accessories:

- C rail, see from page 996
- Combination rail, see page 1063

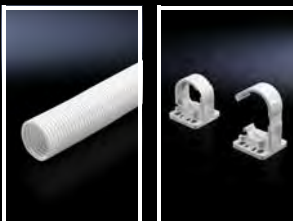
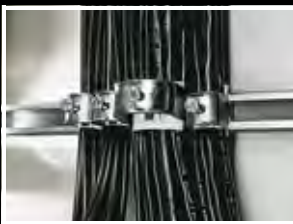

Cable conduit and cable conduit holder

For secure cable routing e.g. from the enclosure or mounting plate to the door. An attachment facility for standard commercially available cable ties is provided on the cable conduit holder, so that cables may be attached upon entry to/exit from the cable conduit.

Material:

- Cable conduit: Polyethylene
- Cable conduit holder: Polyamide

Cable conduit

Internal Ø mm	Packs of	Model No.
16	25 m	2595.000
29	25 m	2589.000
36	25 m	2596.000
48	25 m	2590.000

Cable conduit holder

For cable conduit Ø mm	Packs of	Model No.
16	20 pc(s).	2593.000
29	20 pc(s).	2591.000
36	20 pc(s).	2594.000
48	20 pc(s).	2592.000

! Also required:

- For the installation in AX: Rail for interior installation AX, see page 989 or punched section with mounting flange 14 x 39 mm, see page 952/990



Cable management

Cable routing inside the enclosure

Cable attachment

For professional, secure fastening of cables and conduits.

For fastening:

- Slide into the punched rail 23 x 23 mm,
- Screw-fasten onto the round punchings of the enclosures, as well as all punched rails and punched sections

Material:

- Polyamide

Note:

- As the attachments are bayable, several attachments, even those of different sizes, can be assembled using just 2 screws

For cable diameter from – to mm	Packs of	Model No.
6 – 9	50 pc(s).	4319.090
9 – 12	50 pc(s).	4319.120
12 – 16	50 pc(s).	4319.160
16 – 20	50 pc(s).	4319.200



Also required:

- Posidrive raised countersunk screw M5 x 12 mm, 2488.000, for screw-fastening to the round system punchings, see page 1004



Accessories:

- Punched rail 23 x 23 mm, see page 994



Cable tie

The super-fast solution for fastening cables to the enclosure profile or mounting system parts. Simply clip into the round system punchings.

Length mm	Packs of	Model No.
150	100 pc(s).	2597.000



Nylon loop

With the nylon loop, secured cables are easily released, allowing individual cables to be added or removed. Ideal for sensitive data cables (fibre-optic/Cu), as it avoids indentations on the cable sheathing. In addition, the nylon loop may be screw-fastened to the round system punchings or attached using a quick-release fastener.

Colour:

- Black

Supply includes:

- Quick-release fasteners

Width mm	Length mm	Max. cable diameter mm	Packs of	Model No.
20	130	30	10 pc(s).	7072.220
20	200	50	10 pc(s).	7072.230
20	300	90	10 pc(s).	7072.240



Also required:

- Screw 2486.600 for screw-fastening to the round system punchings, see page 1004

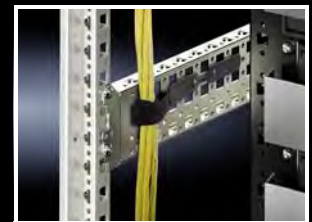

Nylon tape

For tidy cable routing. Supplied on a reel for cutting to the required length.

Unlike cable ties, nylon tape

- protects the cable sheathing
- is easily reopened and
- is reusable

Length mm	Width mm	Packs of	Model No.
5000	16	1 pc(s).	2203.400

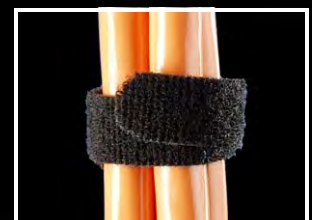

Cable management

Cable routing inside the enclosure

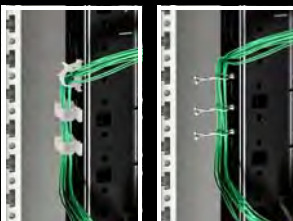
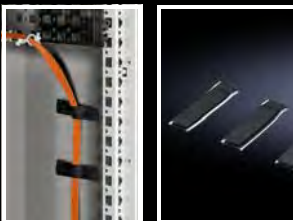
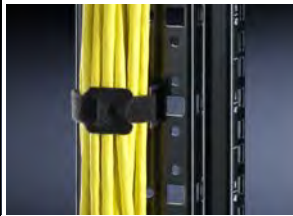

Nylon tape holder

- For simple, fast cable attachment
- Tool-free mounting in the system punchings with 10.5 x 12.5 mm, with a quarter rotation
- Direct use on the horizontal VX frame section, on the support strips and mounting angles of the VX IT 482.6 mm (19") interior installation, on the cable route or on punched sections with mounting flanges
- Length of nylon tape: 400 mm

Material:

- Plastic

Supply includes:

- 10 nylon tapes
- 10 holders

Packs of	Model No.
10 pc(s).	5502.155

Nylon loop cable holder

Self-adhesive

Universally suitable for use in all network enclosures and server racks, wall-mounted enclosures, mounting plates and gland plates.

Material:

- Woven polyamide 6.6

Colour:

- Black

Size length x width mm	Packs of	Model No.
70 x 16	10 pc(s).	7111.350

Snap-in cable routing

for clipping into the system punchings

Cable routing suitable for universal use, for tool-free, fast assembly, in two variants:

For locking

- User-friendly opening for cable management via locating points
- For cable diameters 14 – 19 mm
- For system punchings 6.2 mm

For twisting

- User-friendly opening for cable management
- For cable diameters 10.2 – 12.7 mm
- For system punchings 4.7 mm

Material:

- Polyamide 6.6, self-extinguishing to UL 94-V2

Colour:

- Natural

Version	Packs of	Model No.
For locking, for system punchings 6.2 mm	10 pc(s).	7111.300
For twisting, for system punchings 4.7 mm	10 pc(s).	7111.310

Cable management

Cable routing inside the enclosure

Combination rail

for VX IT

Combination of a C rail for cable clamping with cable clamps and a cable guide rail with T-heads for cable routing. The cables can optionally be secured to the combination rail with cable clamps, cable ties or velcro fasteners to be relieved of strain.

Applications:

- For cable routing and strain relief of routed cables on the VX frame structure

Benefits:

- May be installed on either the outside or inside of the enclosure frame

Installation options:

- Direct screw-fastening between the vertical uprights of the enclosure frame

Material:

- Sheet steel

Surface finish:

- Zinc-plated

Supply includes:

- Assembly parts

For enclosures		Packs of	Model No.
Width mm	Depth mm		
600	600	4 pc(s).	5302.020
800	800	4 pc(s).	5302.021
1000	1000	4 pc(s).	5302.022
1200	1200	4 pc(s).	5302.025



Accessories:

- Cable ties, see page 1061
- Nylon loop, see page 1061
- Angle bracket for combination rail, see page 1063



Angle bracket

for combination rail

For variable mounting of combination rails between two punched sections with mounting flanges in the enclosure interior.

Applications:

- Cascaded cable routing

Benefits:

- Simple clip attachment or optionally screw-fastened

Packs of	Model No.
8 pc(s).	5302.038

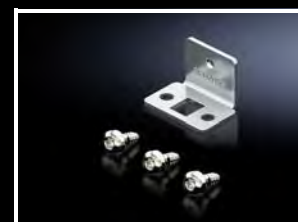

Cable clamp rail, depth-variable

for VX IT, TE

For cable routing on the enclosure frame and for strain relief of the routed cables. The cables can be attached to the cable clamp rails with cable ties or velcro fasteners.

The cable clamp rails can be located horizontally at the rear directly onto a 482.6 mm (19") mounting level or in the enclosure depth between two mounting levels. An additional screw fastening secures the unit.

The depth variability of the rails allows their length to be flexibly adapted to the given mounting distance between the two 482.6 mm (19") mounting levels.

Material:

- Sheet steel

Surface finish:

- Zinc-plated

Supply includes:

- Assembly parts

Mounting dimension ¹⁾ mm	Packs of	Model No.
325 – 575	1 pc(s).	5302.044

¹⁾ Mounting dimensions + 152 mm = distance between 482.6 mm (19") levels



Accessories:

- Cable ties, see page 1061
- Nylon loop, see page 1061



Cable management

Cable routing inside the enclosure

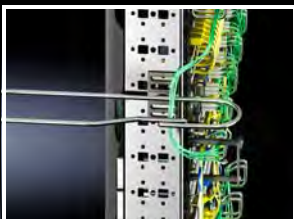

Cable manager

Applications:

- For vertical cable routing and strain relief with network and server applications

Benefits:

- Simple assembly with tool-free quick-release fastening
- Alternatively suitable for screw-fastening
- Integral multifunctional punching for attaching cable routing components
- Integral mounting holes for fixing the PDUs in a 7 U pitch pattern via a keyhole recess

Material:

- Plastic, UL 94-V0

Colour:

- RAL 9005

Supply includes:

- Mounting clips and assembly parts

	Packs of	Model No.
Maxi-kit	20 pc(s).	5502.405

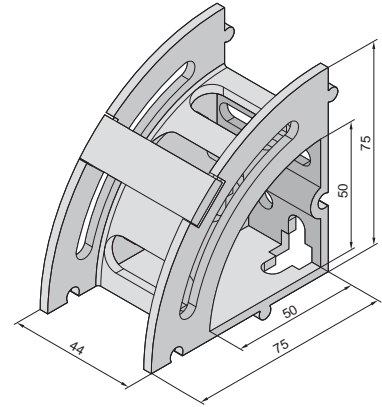

Cable shunting ring

For flexible, system-compatible cable routing at the side of the 482.6 mm (19") mounting angles.

Material:

- Steel

Surface finish:

- Zinc-plated

Supply includes:

- Assembly parts

Dimensions mm	Packs of	Model No.
125 x 85	10 pc(s).	7111.900
125 x 65	10 pc(s).	7111.000
85 x 43	10 pc(s).	7112.000

Shunting ring

To accommodate large quantities of cables. Shunting ring for side attachment to 482.6 mm (19") sections in 800 mm wide network enclosures. The ring is attached asymmetrically providing approx.

110 mm free space in front of the 482.6 mm (19") level. This allows even large quantities of cables to be effectively managed.

Material:

- Steel

Surface finish:

- Zinc-plated

Supply includes:

- Assembly parts

Dimensions mm	Packs of	Model No.
330 x 90/70	4 pc(s).	7220.600

Cable management

Cable routing inside the enclosure

Fibre-optic shunting rings

Fibre-optic shunting or jumper cables can be inserted into the grooves of the inner body. A rubber ring holds different fibre-optic cables up to Ø 4.5 mm. Strain relief and bending radius are ensured.

Length: 120 mm

Material:

- 2K plastic

Colour:

- Exterior: RAL 7035
- Interior: Black

Supply includes:

- 2 rubber rings
- Baying kit
- Assembly parts

Assembly:

The supplied mounting brackets are suitable for universal use; the fibre-optic cables can be routed to the patch panel in all directions in various mounting positions:

- 1 At the side, directly on the patch panel
- 2 In front of the patch panel
- 4 At the side next to the patch panel
- 4 Behind the patch panel

Packs of	Model No.
2 pc(s).	7116.500

Possible alternative:

- Fibre-optic cable management panel, 1 U, see page 1065

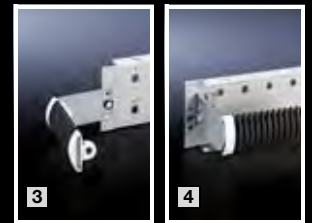

Fibre-optic cable management panel , 1 U

482.6 mm (19")

The four fibre-optic cable shunting rings integrated into the front permit optimum management of individual fibres while allowing for minimum baying radii.

Material:

- Panel: Sheet steel
- Ring: 2K plastic

Colour:

- Panel: RAL 9005
- Cable shunting rings on the outside: RAL 7035, Body: RAL 9005

U	Packs of	Model No.
1	1 pc(s).	5302.203

Possible alternative:

- Fibre-optic cable shunting ring, see page 1065

System supports for cable routes

for VX, VX IT

The depth-variable support system may be attached to all 800 – 1200 mm deep VX enclosures with external screw-fastening of the roof plate. The integral system punchings, for screws or captive nuts, support the attachment of most common cable route systems.

- May be combined with VX IT fan mounting plate
- In combination with punched rail, suitable for accommodating additional cable routing rails or pipelines.
- Support height: 102 mm

Material:

- Sheet steel

Surface finish:

- Powder-coated

Colour:

- RAL 7035

Packs of	Model No.
2 pc(s).	7831.472

Accessories:

- Metal multi-tooth screws 5.5 x 13 mm, 2486.600, see page 1004

Cable management

Cable routing inside the enclosure

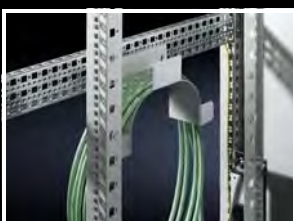
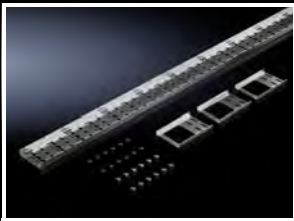

Cable route for VX, VX IT

Applications:

- For vertical cable routing and strain relief with network and server applications

Installation options:

- On the VX IT frame between the roof and base frames, all-round
- In 800 mm wide VX IT racks, alternatively, screw-fastening between the upper and lower depth stays is supported

Benefits:

- Simple assembly with tool-free quick-release fastening
- Alternatively suitable for screw-fastening
- Integral multifunctional punching for attaching cable routing components
- Integral mounting holes for fixing the PDUs in a 7 U pitch pattern via a keyhole recess

Material:

- Sheet steel

Surface finish:

- Spray-finished

Colour:

- RAL 9005

Supply includes:

- Assembly parts

Width mm	Height mm	Packs of	Model No.
145	2000	1 pc(s).	5302.120
145	2200	1 pc(s).	5302.122
265	2000 – 2200	1 pc(s).	5302.322



Accessories:

- Cable ties, see page 1061
- Nylon tape, see page 1061
- Nylon tape holder, see page 1062
- Wall-mounted enclosures, see page 1064
- Cable routing bars, see page 1067

Cable route for TE

For vertical cable entry at the side of the 482.6 mm (19") mounting frame for TE, independently from the enclosure frame.

Material:

- Sheet steel

Surface finish:

- Zinc-plated

Supply includes:

- Assembly parts

Width mm	Height mm	Packs of	Model No.
100	1700	1 pc(s).	7000.685

Surplus cable holder

For fastening at the rear area of the enclosure, or at the side of network enclosures. The surplus cable holder can be attached to all depth stays or to punched sections and rails with a 25 mm pitch pattern – mounting dimension 150 mm.

Material:

- Sheet steel

Surface finish:

- Zinc-plated

Colour:

- RAL 7035

Supply includes:

- Assembly parts

W x H x D mm	Packs of	Model No.
280 x 151 x 75	1 pc(s).	7220.500

Cable management

Cable routing 19"

Cable routing bars, 482.6 mm (19") attachment

For structured routing of entire cable bundles, the cable bars may be secured to a variety of different positions inside the enclosure.

Applications:

- For horizontal cable routing within the distributor level. Thanks to their open mounting holes, they can also be retrospectively slotted onto the 482.6 mm (19") system punchings of the mounting level at any time and secured with the existing mounting screws of the installed components.

Material:

- Support: Sheet steel
- Cable routing bars, connection combs: Plastic UL 94-V0

Colour:

- RAL 9005

Supply includes:

- Cable routing bars
- Connection combs

Note:

- Size of individual chambers (WxD) approx. 34 x 100 mm

Units U	Number of connection combs	Packs of	Model No.
4	2	4 pc(s).	7111.224
1	8	10 pc(s).	7111.214



Cable routing bars for universal use

For structured routing of entire cable bundles, the cable bars may be secured to a variety of different positions inside the enclosure.

Applications:

- All-round attachment for universal use for vertical and horizontal cable routing inside the enclosure or within the distributor level.

Material:

- Support: Sheet steel
- Cable routing bars, connection combs: Plastic UL 94-V0

Colour:

- RAL 9005

Supply includes:

- Cable routing bars
- Connection combs

Note:

- Size of individual chambers (WxD) approx. 34 x 100 mm

Units U	Number of connection combs	Packs of	Model No.
4	2	4 pc(s).	7111.222
1	5	10 pc(s).	7111.212



Cable management

Cable routing 19"



Cable duct

for VX IT, TE

Cable duct for concealed cable routing. Convenient access to the cabling at any time via the hinged duct cover, optionally removable. The duct has cable entry options to the enclosure interior and through the rear panel of the duct. The cable retaining bars enclosed with the duct are snap-mounted onto the cable fingers of the duct with variable depth to support cable routing. Alternatively, the cable duct may also be screw-fastened. For optimum air routing, it may be combined with the brush kit for VX IT.

Benefits:

- Simple assembly with tool-free quick-release fastening
- High packing density due to U-based cable routing
- Suitable for back-to-back baying
- Cable duct may be used as a shielding element to prevent air short-circuits within cold aisle containment
- Lockable cable glands, may be fitted with installation components on the 1 U mounting standard

Material:

- Sheet steel
- Plastic to UL 94-HB

Colour:

- RAL 9005

Supply includes:

- Cable duct
- 2 covers
- 14 cable fingers, 6 U
- 10 cable retaining bars
- Assembly parts



Accessories:

- Brush kit, see page 1068
- Cable management panel with brush strip, see page 1074
- Blanking panel, 482.6 mm (19"), see page 1093

For enclosure	For enclosure width mm	For enclosure height mm	Units U	Packs of	Model No.
VX IT TE 8000 Data Rack	800	1800 2000 1900	38	1 pc(s).	5302.051
VX IT Data Rack	800	2000 2122	42	1 pc(s).	5302.052
VX IT	800	2200	47	1 pc(s).	5302.053

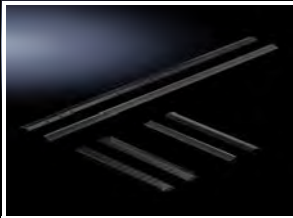

Brush kit

for cable duct VX IT

For all-round shielding of the 482.6 mm (19") mounting level and targeted routing of the cold air flow to the installed equipment.

Applications:

- The brush kit is designed for combining two vertical cable ducts on both sides of the 482.6 mm (19") mounting level. The brush kit may be combined with a cable duct and used as an alternative to the air baffle plate.
- A combination with air baffle plate and cable duct is also possible as partial installation

Benefits:

- Simple assembly with tool-free quick-release fastening
- Alternatively suitable for screw-fastening
- Tailored to the maximum enclosure height 47 U for cutting to the required individual length

Functions:

- The brush kit consists of vertical brush strips for the area between the cable duct and side panel as well as horizontal air baffle plates with brush strips for sealing in the roof and floor area on the 482.6 mm (19") mounting level

Installation options:

- 482.6 mm (19") mounting angles, standard
- 482.6 mm (19") mounting angles, dynamic

Material:

- Brush strip: Plastic, UL 94-V0
- Bristles: Plastic, UL 94-HB
- Air baffle plates: Sheet steel, spray finished

For enclosure width mm	Bristle length mm	Packs of	Model No.
800	48	1 pc(s).	5302.036

Colour:

- RAL 9005

Supply includes:

- 2 brush strips, vertical
- 2 air baffle plates, horizontal, including brush strip
- Assembly parts



Also required:

- Blanking panel, 482.6 mm (19"), see page 1093



Assembly instruction:

- When using the cable duct combined with the brush kit as an air routing component, the cable entry openings in the cable duct must be closed or covered with a cable management panel with brush strip



Accessories:

- Cable management panel with brush strip, see page 1074

Cable management

Cable routing 19"

Cable finger

for VX IT

For structured cable routing on the 482.6 mm (19") mounting level in 1 U increments.

Benefits:

- Simple, tool-free installation by snap-mounting directly into the 482.6 mm (19") mounting angle

Installation options:

- Installation is possible both on the front and on the side of the mounting angles at the front and rear

Material:

- Plastic to UL 94-V0

Colour:

- RAL 9005

Note:

- Cable routing in conjunction with air baffle plates is supported

Units U	Design	Packs of	Model No.
6	for VX IT 482.6 mm (19") mounting angles, dynamic	14 pc(s).	5302.046
6	for VX IT 482.6 mm (19") mounting angles, standard	14 pc(s).	5502.115



Complete CAT 6 system

for Network Cable Organizer

Modern network infrastructures rely on maximum performance and the greatest possible flexibility in cabling. A useful component here is the Network Cable Organizer (NCO). The robust 1 U mounting frame is pre-configured with 24 cable cassettes and revolutionises conventional structured cabling with 8 times faster installation.

Applications:

- For use in all network racks from a depth of 800 mm.

Benefits:

- Minimise cable chaos – Prevent obstructions to the air circulation in the vicinity of network switches
- Always the right length: Surplus cable lengths – whether CAT 6 or fibre-optic – are simply withdrawn with a spring balancer
- Every cable is 100% tested and supplied with a corresponding measurement record
- Front access – Ideal for retrofitting into racks with a depth of 800 mm or more

Functions:

- Attachment to the front and rear 482.6 mm (19") level

Technical specifications:

- CAT 6 cable STP
- 2 x RJ 45 connectors per cable
- Shielded RJ 45 connector with gold-coated pins
- Usable cable length per cassette: 1.6 m
- ISO/IEC 11801:2002, AWG 36, 100% copper, 250 MHz

Material:

- Mounting frame: Sheet steel
- Cassettes: Stainless steel, plastic (POM)

Colour:

- Mounting frame: RAL 9005

Supply includes:

- Complete CAT 6 system
- 24 CAT 6 cassettes
- Installation kit
- Assembly parts



Accessories:

- Mounting frame, see page 1070
- Blanking cover, see page 1071
- Identification labels, see page 1071



Units U	Width mm	Height mm	Depth mm	Colour	Operating temperature range	Packs of	Model No.
1	450	44	600	Cable: black	+10 °C...+45 °C	1 pc(s).	7044.110
1	450	44	600	Cable: blue	+10 °C...+45 °C	1 pc(s).	7044.120
1	450	44	600	Cable: red	+10 °C...+45 °C	1 pc(s).	7044.130
1	450	44	600	Cable: yellow	+10 °C...+45 °C	1 pc(s).	7044.140
1	450	44	600	Cable: green	+10 °C...+45 °C	1 pc(s).	7044.150
1	450	44	600	Cable: violet	+10 °C...+45 °C	1 pc(s).	7044.160
1	450	44	600	Cable: white	+10 °C...+45 °C	1 pc(s).	7044.170

Cable management

Cable routing 19"



Mounting frame

for Network Cable Organizer

Robust 1 U mounting frame for 24 cable cassettes. For individual configuration of the Network Cable Organizer.

Applications:

- For use in all network racks from a depth of 800 mm.
- Attachment to the front and rear 482.6 mm (19") level

Benefits:

- Minimise cable chaos – Prevent obstructions to the air circulation in the vicinity of network switches
- Always the right length: Surplus cable lengths – whether CAT 6 or fibre-optic – are simply withdrawn with a spring balancer
- Front access – Ideal for retrofitting into racks with a depth of 800 mm or more

Material:

- Mounting frame: Sheet steel

Colour:

- Mounting frame: RAL 9005

Supply includes:

- Robust, 1 U sheet steel mounting frame for 24 cable cassettes
- Installation kit
- Assembly parts



Accessories:

- Blanking cover, see page 1071
- Identification labels, see page 1071
- CAT 6 cassettes, see page 1070
- Fibre-optic cassettes, see page 1071

Units U	Width mm	Height mm	Depth mm	Design	Operating temperature range	Packs of	Model No.
1	450	44	600	Item is configurable, options available for selection	+10 °C...+45 °C	1 pc(s).	7044.010



CAT 6 cassettes

for Network Cable Organizer

CAT 6 cassettes for self-configuration in the complete Network Cable Organizer system and for independent assembly in the Network Cable Organizer mounting frame.

Applications:

- Network Cable Organizer
- Mounting frame

Material:

- Cassettes: Stainless steel, plastic (POM)

Colour	Packs of	Model No.
Cable: black	3 pc(s).	7044.113
Cable: blue	3 pc(s).	7044.123
Cable: red	3 pc(s).	7044.133
Cable: yellow	3 pc(s).	7044.143
Cable: green	3 pc(s).	7044.153
Cable: violet	3 pc(s).	7044.163
Cable: white	3 pc(s).	7044.173

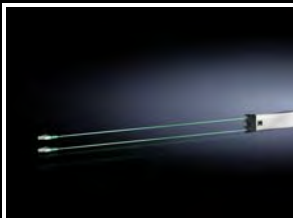

Cable management

Cable routing 19"

Fibre-optic cassettes

for Network Cable Organizer

Fibre-optic cassettes for Network Cable Organizer mounting frame.

Benefits:

- Always the right length: Surplus cable lengths – whether CAT 6 or fibre-optic – are simply withdrawn with a spring balancer
- Every cable is 100% tested and supplied with a corresponding measurement record
- Secure locking – Each cable cassette has a cable attachment to avoid mechanical strain on the cable

Material:

- Cassettes: Stainless steel, plastic (POM)

Cable version	Colour	Packs of	Model No.
Connector type 1: LC duplex / connector type 2: LC duplex Fibre-optic cable, OS2 RBS 9 µ/125 µ Single mode, ISO/IEC 11801 EN 50173	Cable: yellow	3 pc(s).	7044.210
Connector type 1: LC duplex / connector type 2: SC duplex Fibre-optic cable, OS2 RBS 9 µ/125 µ Single mode, ISO/IEC 11801 EN 50173	Cable: yellow	3 pc(s).	7044.211
Connector type 1: LC duplex / connector type 2: LC duplex Fibre-optic cable, OM3 RBS 50 µ/125 µ Multi mode, ISO/IEC 11801 EN 50173	Cable: aqua	3 pc(s).	7044.230
Connector type 1: LC duplex / connector type 2: SC duplex Fibre-optic cable, OM3 RBS 50 µ/125 µ Multi mode, ISO/IEC 11801 EN 50173	Cable: aqua	3 pc(s).	7044.231
Connector type 1: LC duplex / connector type 2: LC duplex Fibre-optic cable, OM4 RBS 50 µ/125 µ Multi mode, ISO/IEC 11801 EN 50173	Cable: violet	3 pc(s).	7044.240
Connector type 1: LC duplex / connector type 2: SC duplex Fibre-optic cable, OM4 RBS 50 µ/125 µ Multi mode, ISO/IEC 11801 EN 50173	Cable: violet	3 pc(s).	7044.241

Blanking cover

for Network Cable Organizer

For covering unused slots in the Network Cable Organizer.

Material:

- Plastic POM

Packs of	Model No.
10 pc(s).	7044.020

Identification labels

for Network Cable Organizer

Identification labels for Network Cable Organizer.

Supply includes:

- 2 DIN A5 sheets of 48 labels

Design	Packs of	Model No.
White, on DIN A5 sheet	1 pc(s).	7044.178

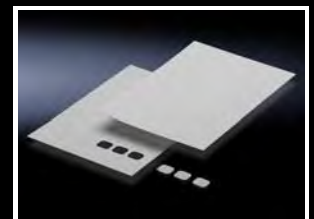

Cable management

Cable routing 19"

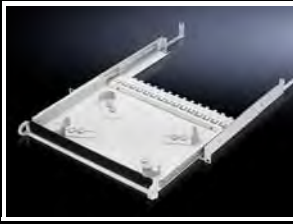

Drawer 482.6 mm (19")

to accommodate surplus cables

The 1 U drawer offers a convenient opportunity for storing surplus cables in an organised, compact and secure way within the 482.6 mm (19") levels.

Applications:

- May be fitted between two 482.6 mm (19") levels
- For mounting on L-shaped mounting angles, cranked mounting angles or mounting frames

Benefits:

- With brush strip at the front for cable entry
- T-head rail in the rear section for cable clamping
- Ring-shaped kink-free routing of the conductors on adjustable elements in the interior

Material:

- Sheet steel

Colour:

- RAL 7035

Supply includes:

- Drawer
- Telescopic slides
- Assembly parts

Units U	Distance between levels mm	Packs of	Model No.
1	435 - 750	1 pc(s).	7063.200



Cable management panel

with plastic rings

For horizontal management of the patch cables, with 5 cable shunting rings.

Width:

- 482.6 mm

Material:

- Panel: Sheet steel
- Ring: Plastic UL 94-V0

Supply includes:

- Cable management panel
- Cable shunting rings (supplied loose)

Note:

- The sizes given are external dimensions.

Units U	Ring size mm	Colour	Packs of	Model No.
1	70 x 44	RAL 9005	1 pc(s).	7159.017

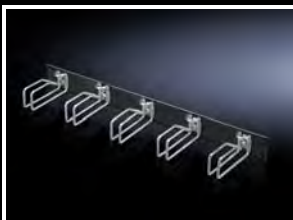

Cable management panel

with steel rings

For horizontal management of the patch cables, with 5 cable shunting rings.

Width:

- 482.6 mm

Material:

- Panel: Sheet steel
- Ring: Steel

Surface finish:

- Panel: Spray-finished
- Ring: Zinc-plated

Note:

- The sizes given are external dimensions.

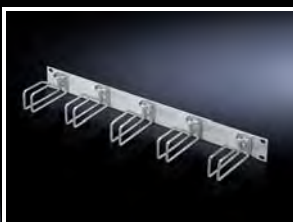

Units U	Ring size mm	Colour	Packs of	Model No.
1	105 x 43	RAL 7035	1 pc(s).	7257.035
1	55 x 43	RAL 7035	1 pc(s).	7257.200
2	125 x 85	RAL 7035	1 pc(s).	7257.100
1	105 x 43	RAL 9005	1 pc(s).	7257.005
1	55 x 43	RAL 9005	1 pc(s).	5502.205
2	125 x 85	RAL 9005	1 pc(s).	7257.105

Cable management

Cable routing 19"

Cable management panel

with cable routing bars

For horizontal management of the patch cables with 5 cable routing bars. Opening the individual cable routing bars allows user-friendly modification and extension of the cabling.

Width:

- 482.6 mm

Material:

- Panel: Sheet steel, spray finished
- Cable routing bars: Plastic

Units U	Bar depth mm	No. of bars/ U	Colour	Packs of	Model No.
1	100	5	RAL 9005	1 pc(s).	5502.225



Cable management panel

with front flap

The cable routing chamber has cut-outs from above, into which the patch cables can be inserted. The cable management panel is equipped with a flap and quick-release fasteners at the front, for optimum access to the cables. From the rear, the cables can be inserted via a cut-out with brush strips.

Width:

- 482.6 mm

Material:

- Sheet steel

Surface finish:

- Spray-finished

Surface finish	Units U	Bar depth mm	Colour	Packs of	Model No.
Spray-finished	2	100	RAL 9005	1 pc(s).	5502.235



Accessories:

- Cable clamp rail, see page 1063

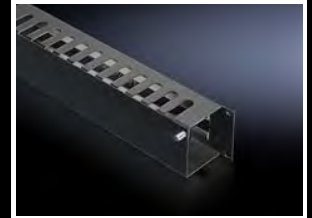

Cable routing channel

482.6 mm (19")

To hold the patching cables.

Width:

- 482.6 mm

Material:

- Sheet steel

Surface finish:

- Spray-finished

Surface finish	Units U	Depth mm	Colour	Packs of	Model No.
Spray-finished	1	85	RAL 9005	1 pc(s).	5502.245



Cable management

Cable routing 19"

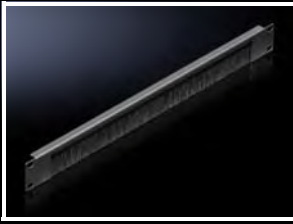

Cable management panel with brush strip

482.6 mm (19")

For convenient, simple cable routing between two areas separated by a 482.6 mm (19") mounting level, for example, between the front and rear areas of the 482.6 mm (19") mounting level.

Applications:

- For locking and simultaneous cable routing in installation zones to the 1 U, 482.6 mm (19") mounting standard

Benefits:

- To make the cable entry larger, two panels are easily combined with one another

Width:

- 482.6 mm

Material:

- Sheet steel
- Brush strip: Plastic, UL 94-HB

Surface finish:

- Spray-finished

Colour:

- RAL 9005

Units U	Packs of	Model No.
1	1 pc(s).	5302.202

+ Accessories:

- Cable clamp rail, see page 1063



Cable tray, depth-variable

for VX IT, TE 8000

For protected cable routing between the front and rear installation area.

Material:

- Sheet steel

Surface finish:

- Spray-finished

Colour:

- RAL 9005

Supply includes:

- Assembly parts



Surface finish	Mounting dimensions mm	Packs of	Model No.
Spray-finished	350 - 550	1 pc(s).	5302.043



Combination rails

for 482.6 mm (19")

The combination rail offers a functional combination of a C rail for cable clamping with cable clamps and a cable guide rail with T-heads for cable routing using cable ties or nylon loops in a rail system.

Applications:

- For cable routing and strain relief on the 482.6 mm (19") level

Material:

- Sheet steel

Surface finish:

- Zinc-plated

Supply includes:

- Assembly parts for the combination rail, without assembly parts for fixing the cables

Height U	Packs of	Model No.
1	4 pc(s).	5302.026

+ Accessories:

- 482.6 mm (19") fastener, 1 U, see page 1097
- Cable clip, see page 1060
- Cable ties, see page 1061
- Nylon loop, see page 1061

482.6 mm (19") installation system

Swing frames

Swing frame, small

for VX, VX SE, AX

for 600 and 800 mm wide enclosures

For mounting 482.6 mm (19") equipment.

Material:

- Sheet steel

Surface finish:

- Zinc-plated

Supply includes:

- 1 cam with double-bit lock insert
- 2 x 130° hinges
- Assembly parts

U	For enclosure/housing	From enclosure height mm	Packs of	Model No.
3		380	1 pc(s).	8619.500
6	VX, VX SE, AX	600	1 pc(s).	8619.510
9		600	1 pc(s).	8619.520
12		760	1 pc(s).	8619.530
15	VX, VX SE	-	1 pc(s).	8619.540
18		-	1 pc(s).	8619.550

Note:

- For the installation in baying enclosure system VX, VX SE, see page 1076



Also required:

- The swing frame stay is required to lock the open swing frame 8619.270, see page 1078



Accessories:

- 482.6 mm (19") fastener, 1 U, 2090.000, see page 1097



For mounting in compact enclosures AX, the following components are also required:

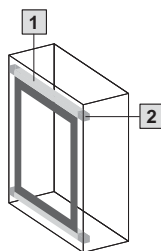

[1] Installation kit	1 pc(s).	For enclosure width mm		Page
		600	800	
		8619.600	8619.610	1076
[2] Mounting kit AX	4 pc(s).	2034.010	2034.010	1076

Max. installation depth for compact enclosures AX

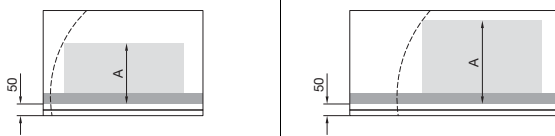

Enclosure dimensions mm		A = max. installation depth mm with internal mounting	
Width	Depth	Centre	Side
600	210	130	-
600	250	170	-
600	350	220	-
600	400	220	-
600	500	-	-
600	600	-	-
600	800	-	-
800	300	210	210
800	400	310	310
800	500	-	-
800	600	-	-
800	800	-	-

482.6 mm (19") installation system

Swing frames

Swing frame, small

for VX, VX SE, AX
for 600 and 800 mm wide enclosures

For the installation in baying enclosure system VX, VX SE, the following components are also required:

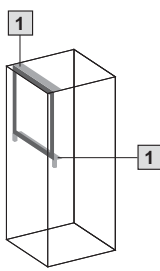
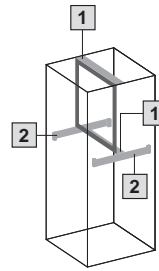
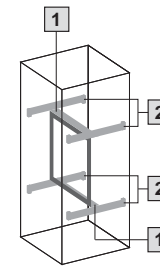
Installation ¹⁾		Front, top/bottom	Set back, top/bottom	Set back/front, centre
				
[1] Installation kit	1 pc(s).	For enclosure width mm		Page
		600	800	1076
[2] Punched section with mounting flange 23 x 64 mm, 2 or 4 pc(s). required	For enclosure depth mm			
	400	4 pc(s).	8617.110	991
	500	4 pc(s).	8617.120	991
	600	4 pc(s).	8617.130	991
	800	4 pc(s).	8617.140	991

¹⁾ For the installation in VX SE, the adaptor rail VX is required, see page 995

Note:

Product information, see page 1075



Installation kit

for swing frame, small, and partial mounting plate

For mounting the small swing frame in AX, VX, VX SE or a partial mounting plate (in conjunction with a hinge for partial mounting plates).

Installation options:

- In VX, VX SE
 - Directly on the enclosure section in the foremost position
 - In conjunction with punched section with mounting flange 23 x 64 mm, offset in the depth

Load capacity:

- Up to 1500 N

Material:

- Sheet steel

Surface finish:

- Nickel-plated

Supply includes:

- Assembly parts

For enclosure width mm	Packs of	Model No.
600	1 pc(s).	8619.600
800	1 pc(s).	8619.610



Also required:

- For the installation in compact enclosures AX: Mounting kit AX, see page 1076
- For the installation in standalone rack VX SE: Adaptor rail VX, see page 995



Mounting kit AX

for installation kit for swing frame, small

For mounting the small swing frame in compact enclosures AX.

Supply includes:

- 4 mounting brackets

Note:

- 1 pack is sufficient for mounting one small swing frame

Packs of	Model No.
1 pc(s).	2034.010

482.6 mm (19") installation system

Swing frames

Swing frame, large

for VX, VX SE

for 600, 800 and 1200 mm wide enclosures

For mounting 482.6 mm (19") equipment.

Material:

– Sheet steel

Surface finish:

– Frame: Zinc-plated
– Trim panels: Spray finished

Colour:

– Trim panels: RAL 7035

Supply includes:

– Lock system, 130° hinge and parts for attaching to the installation kit

Note:

– The swing frame stay is required to lock the open swing frame 8619.270, see page 1078



Accessories:

– 482.6 mm (19") fastener, 1 U, 2090.000, see page 1097

Installation options

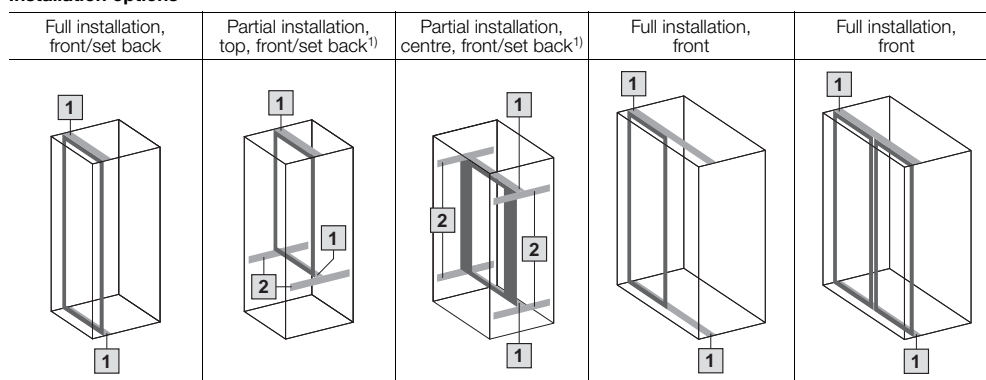

Trim panel		Without	One side	Both sides	Page
For enclosure width mm		600	800	800	
U	For min. enclosure height mm	Packs of	Model No.		
22	1200	1 pc(s).	8619.010	8619.020	8619.030
31	1600	1 pc(s).	8619.011	8619.021	–
35	1800	1 pc(s).	8619.012	8619.022	8619.032
40	2000	1 pc(s).	8619.013	8619.023	8619.033
44	2200	1 pc(s).	8619.014	8619.024	8619.034
Lock system					
Cam lock		■	–	–	
Locking rod		–	■	■	

Also required

[1] Installation kit		For enclosure width mm	Packs of			
		600	1 pc(s).	8619.040	–	–
		800	1 pc(s).	8619.041	8619.041	8619.041
		1200	1 pc(s).	8619.042	8619.042	8619.042
[2] Punched section with mounting flange 23 x 64 mm, 2 or 4 pc(s). required		Installation in enclosure depth mm	Packs of			
		400	4 pc(s).	8617.110	8617.110	8617.110
		500	4 pc(s).	8617.120	8617.120	8617.120
		600	4 pc(s).	8617.130	8617.130	8617.130
		800	4 pc(s).	8617.140	8617.140	8617.140

Accessories

Comfort handle AX		–	see page	see page	939
Lock inserts, type A		–	see page	see page	939
180° hinges for VX ²⁾	1 pc(s).	8619.050	8619.050	8619.050	1078

¹⁾ For the installation in VX SE, the adaptor rail VX is required, see page 995

²⁾ Only in conjunction with 800 mm wide installation kit

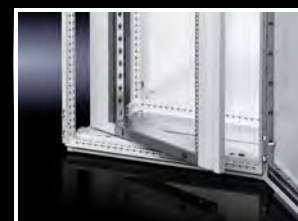

482.6 mm (19") installation system

Swing frames



Installation kit

for swing frame, large

For mounting

- Directly on the enclosure section when installed across the entire enclosure height
- In conjunction with punched section with mounting flange 23 x 64 mm, for partial installation in the enclosure height

Material:

- Sheet steel, 3 mm

Surface finish:

- Spray-finished

Colour:

- RAL 7035

Supply includes:

- Assembly parts

For enclosure width mm	Load capacity N	Packs of	Model No.
600	3500	1 pc(s).	8619.040
800	3500	1 pc(s).	8619.041
1200	1500	1 pc(s).	8619.042



Swing frame stay

Secures the swing frame in the open position.

For mounting on swing frame, large

- 8619.270 at the top of the enclosure
- 1980.200 at the bottom of the enclosure (with safety stop at 160°)

	Packs of	Model No.
For 130° hinge	1 pc(s).	8619.270
For 180° hinge	1 pc(s).	1980.200



For mounting on swing frame, small

- 8619.270, may be mounted at the top or bottom on the installation kit



180° hinge

for swing frame, large, for VX

To extend the opening angle from 130° to 180° in the foremost installation position.

Provides optimum access to the components and 482.6 mm (19") components located behind the swing frame.

Load capacity:

- Up to 1500 N

Material:

- Die-cast

Note:

- Only suitable for installation in VX

Packs of	Model No.
1 pc(s).	8619.050



Slide rail

for swing frames

To support heavy slide-in 482.6 mm (19") electronic equipment in the swing frame.

Material:

- Sheet steel

Surface finish:

- Zinc-plated

For slide-in equipment with max. installation depth	Packs of	Model No.
< 190 mm	10 pc(s).	1962.200
> 190 mm	10 pc(s).	1963.200

482.6 mm (19") installation system

Accessories for Data Rack

Second pair of mounting angles

for Data Rack

To accommodate 482.6 mm (19") network components or for the attachment of component shelves and slide rails. 482.6 mm (19") punched profile at the front, hole centre distance 465 mm (470 mm at the rear), tailored to the attachment of patch panels and cable routing rails. The mounting level may be positioned on a 50 mm pitch pattern. Minimum distance between levels 150 mm, maximum distance between levels 350 mm.

Material:

– Sheet steel, 2 mm

Surface finish:

– Spray-finished

Colour:

– Profile frame: RAL 7035

– Trim panel: RAL 5018

Supply includes:

– Torsionally stiff profile frame with 482.6 mm (19") punchings
– Mounting accessories

Units U	Packs of	Model No.
31	1 pc(s).	7296.000
36	1 pc(s).	7297.000
40	1 pc(s).	7298.000
45	1 pc(s).	7299.000



Accessories:

– Depth stays, see page 1079

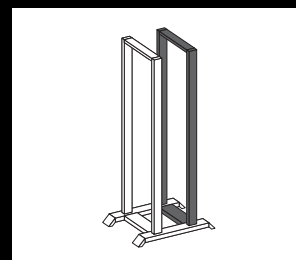
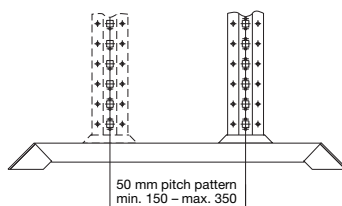

Baying connector

for Data Rack

For assembling rows of distributor frames, or for cable routing between data racks.

Material:

– Sheet steel

Surface finish:

– Spray-finished

Length mm	Packs of	Model No.
53	3 pc(s).	7494.000

Colour:

– RAL 7035

Supply includes:

– Assembly parts



Depth stays

for Data Rack

For securing and stabilising two pairs of 482.6 mm (19") mounting angles in the Data Rack. The length of the depth stays is adjustable, and can accommodate the following spacings of mounting angles: 250, 300 and 350 mm.

Material:

– Sheet steel

Surface finish:

– Spray-finished

Packs of	Model No.
2 pc(s).	7401.000

Colour:

– RAL 7035

Supply includes:

– Assembly parts



Slide rail, 2 U, static installation, continuous

for two pairs of 482.6 mm (19") mounting angles

To support heavy equipment in the Data Rack. The mounting dimensions of the slide rails were selected to enable them to be combined with 500 mm deep, 482.6 mm (19") component shelves. The mounting distance of the 482.6 mm (19") mounting angles is 350 mm.

Material:

– Sheet steel

Surface finish:

– Zinc-plated

Load capacity:

– 500 N, static

Supply includes:

– Assembly parts

Packs of	Model No.
2 pc(s).	7402.000



Also required:

– Second pair of mounting angles, see page 1079



Accessories:

– 482.6 mm (19") fastener, 1 U, see page 1097

– Component shelf for frame attachment, see page 1006



482.6 mm (19") installation system

Mounting angles

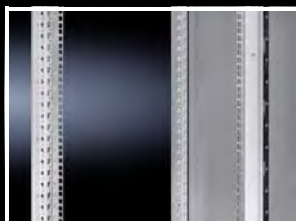

Adaptor section, 482.6 mm (19")

for VX, VX SE, enclosure width 600 mm

For mounting electronic components, subracks and other 482.6 mm (19") equipment. Adaptor sections are easily shortened for partial assemblies.

Material:

- Sheet steel, 2 mm

Supply includes:

- Assembly parts

Note:

- The 482.6 mm (19") measurement applies when mounting on the frame
- Depth-offset installation is possible using punched sections with mounting flanges, 18 x 64 mm

For enclosure height mm	U	Packs of	Model No.
1600	33	2 pc(s).	8619.300¹⁾
1800	38	2 pc(s).	8619.310
2000	42	2 pc(s).	8619.320¹⁾

¹⁾ For the rear of electronic enclosures, see page 130

+ Accessories:

- 482.6 mm (19") fastener, 1 U, see page 1097
- Slide rail VX for adaptor section 482.6 mm (19") with attachment on one side, see page 1089
- Slide rail VX for adaptor section 482.6 mm (19") with attachment on both sides, see page 1089
- Punched section with mounting flange, 18 x 64 mm, see page 990
- Multi-tooth screws, see page 1004
- Metal multi-tooth screws, see page 1004
- Self-tapping screws, see page 1004

Installation examples for VX

Foremost installation position

In conjunction with a sheet steel door

In conjunction with a glazed door

Offset installation position

May be depth-mounted on a 25 mm pitch pattern on punched sections with mounting flanges

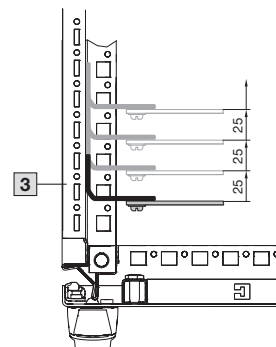
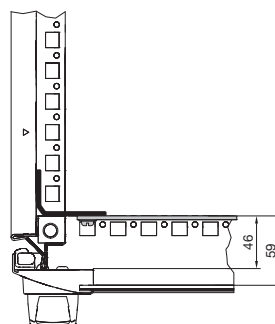
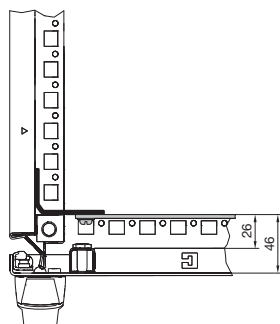

Installation examples for VX SE

Foremost installation position

On adaptor rail VX in conjunction with a sheet steel door

On adaptor rail VX in conjunction with a glazed door

1 Adaptor sections 482.6 mm (19")

2 Adaptor rail VX

3 Punched section with mounting flange 18 x 64 mm

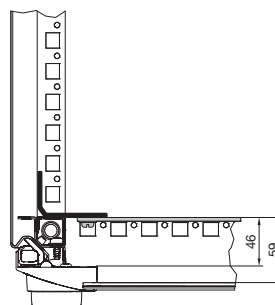
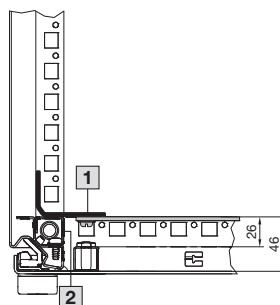

482.6 mm (19") installation system

Mounting angles

Adaptor pieces, 482.6 mm (19") for VX, VX SE

The 1 U sub-section of adaptor sections. For the installation of subracks and other 482.6 mm (19") equipment.

Material:

- Sheet steel, 2 mm

Supply includes:

- Assembly parts

Note:

- The 482.6 mm (19") measurement applies when mounting on the frame of 600 mm wide enclosures
- Depth-offset installation in 600 mm wide enclosures is possible using punched sections with mounting flanges, 18 x 64 mm

Units U	Packs of	Model No.
1	4 pc(s).	8619.330

+ Accessories:

- 482.6 mm (19") fastener, 1 U, see page 1097
- Punched section with mounting flange, 18 x 64 mm, see page 990
- Multi-tooth screws, see page 1004
- Metal multi-tooth screws, see page 1004
- Self-tapping screws, see page 1004



482.6 mm (19") mounting angles, standard for VX IT

Suitable for assembling a 482.6 mm (19") mounting level or for 482.6 mm (19") partial installation. The L-shaped design directly accommodates all commercially available installation kits for server systems, which are fastened directly to the 482.6 mm (19") system punchings.

The L-shaped design directly accommodates all commercially available installation kits for server systems, which are fastened directly to the 482.6 mm (19") system punchings.

Applications:

- For mounting a 482.6 mm (19") mounting level within the VX IT rack system

Benefits:

- Integral, bidirectional U labelling
- Integral system punchings on a U pitch pattern on the front and sides, allows U-specific mounting of cable routing components for structured cabling

Installation options:

- Alternative installation widths from 21" - 24", depending on the mounting variant and rack dimensions selected

Technical specifications:

- Side punchings, round and square, on a U pitch pattern
- Potential equalisation within the mounting level and with the locating frame is achieved via the assembly components
- 482.6 mm (19") mounting hole including U centre fixing attachment to standard EIA 310 E

Material:

- Sheet steel, 2 mm

Surface finish:

- Primed

Colour:

- RAL 9005

Supply includes:

- Assembly parts

For enclosure height U	Installation position	Packs of	Model No.
15	front	2 pc(s).	5302.100
15	rear	2 pc(s).	5302.101
24	front	2 pc(s).	5302.102
24	rear	2 pc(s).	5302.103
38	front	2 pc(s).	5302.104
38	rear	2 pc(s).	5302.105
42	front	2 pc(s).	5302.106
42	rear	2 pc(s).	5302.107
47	front	2 pc(s).	5302.108
47	rear	2 pc(s).	5302.109

+ Assembly instruction:

- A combination with cross-member, depth stays or mounting bracket is required for attachment
- Use of the different mounting options depends on the relevant enclosure dimensions

+ Accessories:

- Cross member, see page 1083
- Mounting bracket, see page 1082
- Depth stays, see page 1083

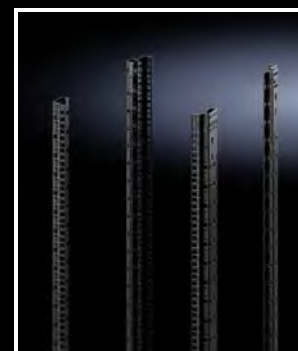

482.6 mm (19") installation system

Mounting angles



482.6 mm (19") mounting angles, dynamic

for VX IT

Suitable for assembling a 482.6 mm (19") mounting level or for 482.6 mm (19") partial installation.

The L-shaped design can directly accommodate all commercially available mounting kits for server systems, which are fastened directly to the 482.6 mm (19") system punchings.

Applications:

- For mounting a 482.6 mm (19") mounting level within the VX IT rack system

Benefits:

- Integral, bidirectional U labelling
- Integral system punchings on a U pitch pattern on the front and sides, allows U-specific mounting of cable routing components for structured cabling

Installation options:

- Alternative installation widths from 21" – 24", depending on the mounting variant and rack dimensions selected

Technical specifications:

- Side punchings, round and square, on a U pitch pattern
- Potential equalisation within the mounting level and with the locating frame is achieved via the assembly components
- 482.6 mm (19") mounting hole including U centre fixing attachment to standard EIA 310 E

Material:

- Sheet steel, 2.5 mm

Surface finish:

- Primed

Colour:

- RAL 9005

Supply includes:

- Assembly parts

For enclosure height U	Installation position	Packs of	Model No.
38	front	2 pc(s).	5302.152
38	rear	2 pc(s).	5302.153
42	front	2 pc(s).	5302.154
42	rear	2 pc(s).	5302.155
47	front	2 pc(s).	5302.156
47	rear	2 pc(s).	5302.157

Assembly instruction:

- A combination with cross-member, depth stays or mounting bracket is required for attachment
- Use of the different mounting options depends on the relevant enclosure dimensions

Accessories:

- Mounting bracket, see page 1082
- Cross member, see page 1083
- Depth stays, see page 1083



Mounting bracket

for VX IT 482.6 mm (19") mounting angles

For mounting 482.6 mm (19") mounting angles in VX IT network/server racks. For racks with a width of 600 mm, they are attached directly to the frame and for racks with a width of 800 mm to the cross-member.

Benefits:

- Direct potential equalisation of the mounting angles via the attachment

Material:

- Sheet steel

Surface finish:

- Clear-chromated

Colour:

- RAL 9005

Supply includes:

- Assembly parts

Design	For enclosure width mm	Packs of	Model No.
for VX IT 482.6 mm (19") mounting angles, standard	600	4 pc(s).	5302.110
for VX IT 482.6 mm (19") mounting angles, dynamic	600	4 pc(s).	5302.160
for cross member	800	4 pc(s).	5302.169

Accessories:

- Cross member, see page 1083

482.6 mm (19") installation system

Mounting angles

Cross member

for VX IT mounting angles, 482.6 mm (19"), standard

For width-variable mounting of standard 482.6 mm (19") mounting angles in 800 mm wide VX IT network/server enclosures.

Benefits:

- Symmetrical or asymmetrical installation supported
- More space for cable routing or integration of a Liquid Cooling Unit (LCU) with one-sided, asymmetrical (laterally offset) installation
- Ideal for integrating 482.6 mm (19") mounting angles for alternative installation with 21", 23", or 24" components
- To boost the energy efficiency of an integral rack climate control system, the surrounding area around the 482.6 mm (19") mounting level can be covered with air baffle plates, enabling the more selective use of the cooling airflow and minimising exhaust airflows

Material:

- Sheet steel

Surface finish:

- Spray-finished

Colour:

- RAL 9005

Load capacity:

- 4000 N

Supply includes:

- Assembly parts

For enclosure width mm	Packs of	Model No.
800	2 pc(s).	5302.167

Note:

- The maximum load capacity of one mounting level on a cross member is 4000 N per mounting level.



Also required:

- Mounting bracket, see page 1082



Assembly instruction:

- It is attached directly onto the enclosure frame
- A cross member mounting bracket is needed to screw-fasten the mounting angles to the cross member



Accessories:

- Air baffle plate, see page 1094



Depth stays

for 482.6 mm (19") mounting angles

To accommodate 19" mounting angles.

Benefits:

- Particularly high load capacity up to 15,000 N
- Enhanced stability thanks to improved load distribution
- Symmetrical or asymmetrical installation supported
- More space for cable routing or integration of a Liquid Cooling Unit (LCU) with one-sided, asymmetrical (laterally offset) installation
- Ideal for integrating 482.6 mm (19") mounting angles for alternative installation with 21", 23", or 24" components

Material:

- Sheet steel

Surface finish:

- Spray-finished

Colour:

- RAL 9005

Supply includes:

- 2 depth stays each for top and bottom for enclosure width > 600 mm
- Assembly parts

Design	For enclosure depth mm	For enclosure width mm	Packs of	Model No.
for VX IT 482.6 mm (19") mounting angles, standard	1000	> 600	1 pc(s).	5302.111
for VX IT 482.6 mm (19") mounting angles, standard	1200	> 600	1 pc(s).	5302.112
for VX IT 482.6 mm (19") mounting angles, dynamic	1000	> 600	1 pc(s).	5302.161
for VX IT 482.6 mm (19") mounting angles, dynamic	1200	> 600	1 pc(s).	5302.164
for VX IT 482.6 mm (19") mounting angles, standard for VX IT 482.6 mm (19") mounting angles, dynamic	1200	600	2 pc(s).	5302.166



Also required:

- Support rail, see page 1084
- Mounting bracket, see page 1082



Assembly instruction:

- For the attachment of mounting angles in enclosures that are greater than 1000 mm deep and greater than 600 mm wide, additional mounting brackets are required
- For the attachment of mounting angles in enclosures that are greater than 1000 mm deep and greater than 600 mm wide, an additional support rail for VX IT is required



482.6 mm (19") installation system

Mounting angles



Support rail

for VX IT

For the attachment of mounting angles in enclosures > 1000 mm deep and 600 mm or 800 mm wide when using depth stays. The support rail improves load distribution in network/server racks.

Technical specifications:

- Side round and square punchings

Material:

- Sheet steel

Supply includes:

- Assembly parts

Packs of	Model No.
1 pc(s).	5302.170

Assembly instruction:

- The support rail is screw-fastened onto the centre of the frame structure at right-angles below the depth stays



Mounting angles additional fastening attachment

for VX IT 482.6 mm (19") mounting angles, standard

Prevents the mounting angles from twisting in case of unevenly distributed loads. Secured directly between the mounting angle and a mounting section on the outer mounting level of the VX frame structure.

Applications:

- For fixing the 482.6 mm (19") mounting angle, standard, onto the outer mounting level

Benefits:

- Can also be used as individual fastening with 482.6 mm (19") partial installation

Material:

- Sheet steel

Surface finish:

- Spray-finished

Colour:

- RAL 9005

Supply includes:

- Assembly parts

For enclosure width mm	Packs of	Model No.
600	2 pc(s).	5302.123
800	2 pc(s).	5302.124

Also required:

- Punched section with mounting flange, 18 x 64 mm, see page 990

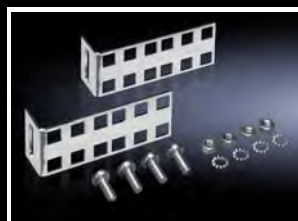

Mounting kit, 2 U

for 482.6 mm (19") equipment

Facilitates fast, simple integration of additional 2 U mounting space within an enclosure by attaching to the enclosure frame or to the existing mounting angles at the sides. The flexible slot fastening of the brackets means that the distance between the two installation brackets may be freely selected, so that other 482.6 mm (19") attachment dimensions may be implemented. The second row of holes is used for the optional configuration of additional mounting surfaces.

Material:

- Sheet steel

Surface finish:

- Zinc-plated

Supply includes:

- Assembly parts

Units U	Packs of	Model No.
2	2 pc(s).	7246.420



482.6 mm (19") installation system

Mounting angles

Mounting angles, 482.6 mm (19")

for FlatBox

L-shaped bracket as 2nd attachment level

Material:

– Sheet steel, spray-finished

Colour:

– RAL 7035

Supply includes:

– Assembly parts for fast, tool-free assembly.

Note:

- The 2nd attachment level should always be ordered in the same height as the basic enclosure
- Partial configuration is not possible

Units U	Packs of	Model No.
6	2 pc(s).	7507.706
9	2 pc(s).	7507.709
12	2 pc(s).	7507.712
15	2 pc(s).	7507.715
18	2 pc(s).	7507.718
21	2 pc(s).	7507.721



Adhesive measurement strip, 482.6 mm (19")

With numerical labelling on a 482.6 mm (19") pitch pattern for clear identification of the various height units.

Applications:

- For retrofitting to existing 482.6 mm (19") sections
- For sticking onto the side adjacent to the system punchings

Benefits:

- Double-sided labelling allows the counting direction to be freely selected
- Clear documentation of the various installed components

Material:

– Sheet steel, spray-finished

Design	Width mm	Packs of	Model No.
Labelling range 1 – 56 U	6	1 pc(s).	7950.100



Cover, magnetic

for VX IT

For optionally covering the front system punchings with complete air blocking of the front, or in the absence of installed cable fingers. With additional labelling strips for bidirectional U labelling.

Applications:

- For retrofitting to existing 482.6 mm (19") sections

Benefits:

- Double-sided labelling allows the counting direction to be freely selected
- Clear documentation of the various installed components

Material:

- Cover: PVC
- Adhesive measurement strips: Plastic

Supply includes:

- Cover (front)
- 2 adhesive measurement strips, self-adhesive, bi-directional

Design	Length m	Width mm	Packs of	Model No.
Labelling range 1 – 56 U	5	15	1 pc(s).	5501.895



482.6 mm (19") installation system

Slide rails

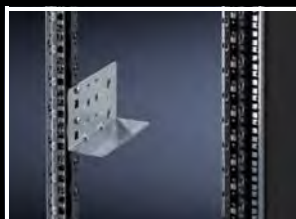

Slide rail, 2 U, static installation for VX IT

System punchings for mounting accessories and cooling active components.

Applications:

- For mounting on a 482.6 mm (19") mounting level

Installation options:

- for 482.6 mm (19") mounting angles, standard
- for 482.6 mm (19") mounting angles, dynamic

Material:

- Sheet steel

Surface finish:

- Zinc-plated

Load capacity:

- 300 N, static

Supply includes:

- Assembly parts

Units U	Length mm	Packs of	Model No.
2	150	2 pc(s).	5501.400



Slide rail, 1 U, static installation for VX IT

Side system punchings for mounting accessories and cooling components that expel to the side.

Applications:

- For mounting on the front mounting level
- To support heavy installed equipment

Benefits:

- Simply locate into the system punchings of the 482.6 mm (19") mounting brackets after adjusting the required 482.6 mm (19") distance between levels

Installation options:

- for 482.6 mm (19") mounting angles, standard

Material:

- Sheet steel

Surface finish:

- Zinc-plated

Load capacity:

- 800 N, static

Supply includes:

- Assembly parts

Note:

- Effective contact surface 35 mm per side

Units U	Length mm	Distance between 482.6 mm (19") levels mm	Packs of	Model No.
1	275	345	2 pc(s).	5501.410
1	375	445	2 pc(s).	5501.420
1	475	545	2 pc(s).	5501.430
1	575	645	2 pc(s).	5501.440
1	675	745	2 pc(s).	5501.450



Assembly instruction:

- The 482.6 mm (19") spacing between levels in the VX IT must be adjusted accordingly prior to installation

482.6 mm (19") installation system

Slide rails

Slide rail, 2 U, static installation, heavy duty for VX IT

Side system punchings for mounting accessories and cooling components that expel to the side.

Applications:

- For mounting on the front mounting level
- To support heavy installed equipment

Benefits:

- Simply locate into the system punchings of the 482.6 mm (19") mounting brackets after adjusting the required 482.6 mm (19") distance between levels

Installation options:

- 482.6 mm (19") mounting angles, standard
- 482.6 mm (19") mounting angles, dynamic

Material:

- Sheet steel

Surface finish:

- Zinc-plated

Load capacity:

- 2000 N, static

Supply includes:

- Assembly parts

Note:

- Effective contact surface 35 mm per side

482.6 mm (19") distance between levels, standard mm	482.6 mm (19") distance between levels, dynamic mm	Packs of	Model No.
320	325	2 pc(s).	5302.030
420	425	2 pc(s).	5302.031
520	525	2 pc(s).	5302.032
620	625	2 pc(s).	5302.033
720	725	2 pc(s).	5302.034



Slide rail, heavy-duty for TE

For L-shaped mounting angles with a preconfigured clearance between levels of 740 mm. Easily and quickly installed due to locating brackets for the rear level.

Material:

- Sheet steel

Surface finish:

- Zinc-plated

Load capacity (static):

- 1000 N

Supply includes:

- Assembly parts

Distance between 482.6 mm (19") levels mm	Contact surface, width mm	Contact surface, depth mm	Packs of	Model No.
745	50	734	2 pc(s).	7063.740



482.6 mm (19") installation system

Slide rails



Slide rail

for TE

For mounting between the front and rear 482.6 mm (19") mounting levels. The slide rails can be used to support heavy 482.6 mm (19") components.

Material:

- Sheet steel

Surface finish:

- Zinc-plated

Load capacity (static):

- 800 N

Supply includes:

- Assembly parts

Distance between 482.6 mm (19") levels mm	Contact surface, width mm	Contact surface, depth mm	Packs of	Model No.
395	85	324	2 pc(s).	7963.310
495	85	424	2 pc(s).	7963.410
595	85	524	2 pc(s).	7963.510
695	85	624	2 pc(s).	7963.610
795	85	724	2 pc(s).	7963.710



Slide rail, 1 U, depth-variable

for VX IT, TE

Applications:

- For mounting on the front mounting level
- To support heavy installed equipment
- To adapt to individual distances between 482.6 mm (19") levels

Benefits:

- Tool-free, time-saving one-man assembly from the enclosure front
- All three mounting holes in the EIA system punchings are available for screw-fastening the equipment.
- Alternatively, direct screw fastening in the TE 8000 to the 482.6 mm (19") system punchings is also possible

Installation options:

- 482.6 mm (19") L mounting angles, front and rear
- 482.6 mm (19") mounting frames front and rear
- for VX IT 482.6 mm (19") mounting angles, standard
- for VX IT 482.6 mm (19") mounting angles, dynamic

Material:

- Sheet steel

Surface finish:

- Zinc-plated

Supply includes:

- Assembly parts

Note:

- Effective contact surface 25 mm per side

Distance between 482.6 mm (19") levels mm	Load capacity (static)	Packs of	Model No.
600 - 900	800 N	2 pc(s).	5302.035
400 - 600	800 N	2 pc(s).	5501.460



482.6 mm (19") installation system

Slide rails

Slide rail, 1 U, depth-variable for VX IT, TE

For direct attachment to the 482.6 mm (19") system punchings on the mounting angles. The slide rails are pulled out to the required length and secured between the front and rear mounting level on the 482.6 mm (19") pitch pattern.

Applications:

- For mounting on the front mounting level

Benefits:

- No loss of U
- Thanks to the thin support surface of only around 0.8 mm thickness, exceeding the U pitch pattern is generally avoided, provided the components do not exceed a maximum height of 43.5 mm. In this way, several units may be easily arranged on top of one another without offset.

Installation options:

- For attachment between the front and rear 482.6 mm (19") mounting level

Distance between 482.6 mm (19") levels mm	Packs of	Model No.
390 - 550	2 pc(s).	7063.750
550 - 750	2 pc(s).	7063.752

Material:

- Sheet steel

Surface finish:

- Zinc-plated

Load capacity:

- 20 kg static load

Supply includes:

- Assembly parts

Note:

- Effective contact surface 30 mm per side

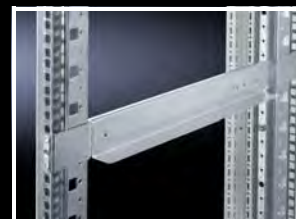

Slide rail VX

for adaptor section 482.6 mm (19") with attachment on both sides

Mounting between the 482.6 mm (19") front and rear adaptor sections or 482.6 mm (19") adaptor pieces.

Material:

- Sheet steel

Surface finish:

- Zinc-plated

Supply includes:

- Assembly parts

For enclosure depth mm	Packs of	Model No.
500	10 pc(s).	8613.151
600	10 pc(s).	8613.161
800	10 pc(s).	8613.181



Slide rail VX

for adaptor section 482.6 mm (19") with attachment on one side

Mounted on the adaptor section, 482.6 mm (19").

Material:

- Sheet steel

Surface finish:

- Zinc-plated

Supply includes:

- Assembly parts

Length mm	Packs of	Model No.
270	10 pc(s).	4531.001



482.6 mm (19") installation system

482.6 mm (19") installation



Server telescopic slides

Facilitate optimum accessibility to the servers, even when built-in. For servers with a maximum width of 426 mm.

Material:

- Sheet steel

Load capacity:

- 30 kg

Supply includes:

- Telescopic slide with mounting kit
- Assembly parts

Note:

- Only in conjunction with L-shaped mounting angles

Design	Extension length mm	For enclosure depth mm	Packs of	Model No.
For 468.6 - 687.4 mm distance between levels	511.2	600	2 pc(s).	3659.180
For 559.0 - 789.0 mm distance between levels	596.4	800	2 pc(s).	3659.190



Adaptor kit, 3 U

for 800 mm wide VX enclosures

For fastening individual 482.6 mm (19") components, or as an additional mounting facility at the rear of the enclosure. The mounting level in the adaptor angle can be adjusted in 25 mm increments by up to 100 mm in the depth, leaving sufficient space for baying where patch panels or splicing boxes are used. Attachment is on the inner mounting level of the frame section or a suitable chassis in the enclosure depth.

Material:

- Sheet steel

Colour:

- RAL 7035

Units U	Design	Packs of	Model No.
3	Installation position, centre	2 pc(s).	7246.100



Adaptor, 3 U

Depth offset 100 mm

This adaptor is used to recess 482.6 mm (19") mounting of equipment inside enclosures with 482.6 mm (19") installation in the foremost position, such as server or electronic enclosures. In this way, sufficient space can be gained in front of the mounting equipment to integrate patch panels or switches, whilst at the same time exploiting the maximum enclosure depth.

Material:

- Sheet steel

Surface finish:

- Zinc-plated

Supply includes:

- Assembly parts

Units U	Packs of	Model No.
3	2 pc(s).	7246.400

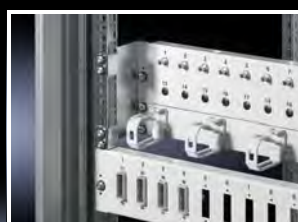

482.6 mm (19") installation system

482.6 mm (19") installation

Adaptor, metric to 21"/19"

Units U	Height SU	Packs of	Model No.
1	2	2 pc(s).	7246.010
3	6	2 pc(s).	7246.030
6	11	2 pc(s).	7246.060

With this adaptor, 482.6 mm (19") assemblies may be fastened to metric (535 mm) mounting angles, or combined systems may be configured.

Material:

- Extruded aluminium section



Drawer

for one 482.6 mm (19") mounting level

For front attachment to mounting angles, 482.6 mm (19"). With cover and telescopic slides to accommodate assignment lists, operating manuals and small parts. The small version of the 2 U variant is also suitable for mounting inside a swing frame.

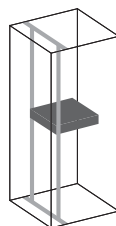

Material:

- Sheet steel

Supply includes:

- Fully assembled
- Security lock 12321
- Assembly parts



Units U	Width	Clearance openings, width mm	Clearance openings, depth mm	Installation depth mm	Colour	Packs of	Model No.
2	19"	411	419	427	RAL 7035	1 pc(s).	7282.035
2	19"	411	244	250	RAL 7035	1 pc(s).	7282.135
3	19"	411	419	427	RAL 7035	1 pc(s).	7283.035
2	19"	411	419	427	RAL 9005	1 pc(s).	5502.305
3	19"	411	419	427	RAL 9005	1 pc(s).	5502.325

Small equipment box, 4 U, shielded

for one 482.6 mm (19") mounting level

For accommodation of small equipment and other accessories within a partitioned 482.6 mm (19") installation level. The small equipment box contains an adjustable mounting base which can be used to further sub-divide the box.

Material:

- Sheet steel
- Brush strip: Plastic, UL 94-HB

Surface finish:

- Spray-finished

Colour:

- RAL 9005

Load capacity:

- 200 N surface load, static

Supply includes:

- Small equipment box with brush strip
- 1 shelf



Contact surface, width mm	Contact surface, depth mm	Height mm	Width mm	Depth mm	Packs of	Model No.
405	300	170	427	400	1 pc(s).	5501.900

482.6 mm (19") installation system

482.6 mm (19") installation



482.6 mm (19") installation aid for Network Cable Organizer

For easier mounting of 482.6 mm (19") installed components within the mounting level.

Applications:

- To support heavy installed equipment

Installation options:

- For mounting on the front mounting level

Material:

- Sheet steel

Colour:

- RAL 9005

Load capacity:

- max. 150 N

Supply includes:

- Assembly parts

Note:

- Effective contact surface 35 mm per side

Packs of	Model No.
1 pc(s).	5502.110

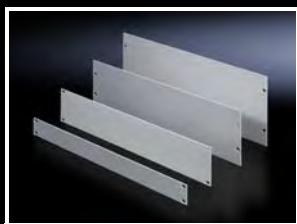

Blanking plate, 482.6 mm (19")

For installation in electronic enclosures or housings.

Benefits:

- To neatly finish off free locations within the mounting level.

Material:

- Aluminium, 3 mm

Surface finish:

- Natural anodised

Units U	Packs of	Model No.
1	3 pc(s).	1931.200
2	3 pc(s).	1932.200
3	3 pc(s).	1933.200
4	3 pc(s).	1934.200
6	3 pc(s).	1936.200
7	3 pc(s).	1935.200
9	3 pc(s).	1939.200
12	3 pc(s).	1937.200



Hinge for blanking plates

Material:

- Die-cast zinc

Surface finish:

- Zinc-plated

Supply includes:

- Assembly parts

Packs of	Model No.
2 pc(s).	1950.000

482.6 mm (19") installation system

482.6 mm (19") installation

Blanking panel, 482.6 mm (19")

As an extension cover or for population as required.

Width:

- 482.6 mm

Material:

- Sheet steel

Colour RAL 7035

Units U	Installation height mm	Width	Packs of	Model No.
1	44	19"	2 pc(s).	7151.035
1.5	66	19"	2 pc(s).	7157.035
2	88	19"	2 pc(s).	7152.035
3	132.5	19"	2 pc(s).	7153.035
6	266	19"	2 pc(s).	7156.035

Colour RAL 9005

Units U	Installation height mm	Width	Packs of	Model No.
1	44	19"	2 pc(s).	7151.005
2	88	19"	2 pc(s).	7152.005
3	132.5	19"	2 pc(s).	7153.005
6	266	19"	2 pc(s).	7156.005



Blanking panel, 482.6 mm (19")

Tool-free attachment

The blanking panel is used to seal unused areas within the 482.6 mm (19") mounting level. Quick tool-free attachment means that it is easily integrated anywhere, and can also be removed again if necessary. The consistent use of blanking panels ensures targeted air routing in partially populated racks.

Material:

- Plastic
- Fire protection: Self-extinguishing, to UL 94 HB, halogen-free

Colour:

- RAL 9005

Supply includes:

- Blanking panel, 1 U, with integral quick-fastening

Installation height U	Width	Packs of	Model No.
1	19"	10 pc(s).	5302.200



Vent trim panel, 482.6 mm (19")

For targeted air infeed from the front zone into the 482.6 mm (19") level.

Applications:

- Targeted routing of cold air from the raised floor via the front to the rear for cooling separate components

Benefits:

- Vented surface area approx. 85 % perforated

Material:

- Sheet steel

Surface finish:

- Spray-finished

Colour:

- RAL 9005

Units U	Packs of	Model No.
1	1 pc(s).	5302.201



Also required:

- 482.6 mm (19") fastener, 1 U, see page 1097
- Multi-tooth screws, see page 1098



482.6 mm (19") installation system

482.6 mm (19") installation

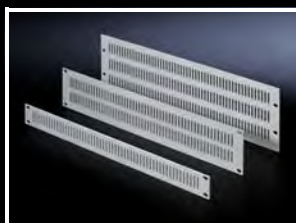

Ventilated front panels

Width 482.6 mm (19")

For venting enclosures and housings.

Material:

- Aluminium

Surface finish:

- Natural anodised

Units U	Packs of	Model No.
1	3 pc(s).	2231.000
2	3 pc(s).	2232.000
3	3 pc(s).	2233.000



Air baffle plate

for VX IT 482.6 mm (19") mounting angles, standard

Applications:

- To separate the hot/cold zones within an enclosure with aisle containment or when using an LCP system.

Benefits:

- For selectively boosting the energy efficiency of a climate control system
- Vertical brush strip for collision-free shielding with installed rail systems on the outer mounting level

Material:

- Sheet steel
- Blanking panel: Plastic, UL 94-HB, halogen-free
- Brush strip: Plastic, UL 94-HB

Surface finish:

- Spray-finished

Colour:

- RAL 9005

Supply includes:

- 2 vertical trim panels
- 2 horizontal trim panels
- 4 brush strips
- 4 cellular PU foam pieces
- Assembly parts

Assembly instruction:

- The vertical trim panels with brush strip may be fitted on both the front and rear 482.6 mm (19") mounting angles for partitioning.
- The horizontal trim panels with brush strips can only be mounted on the front 482.6 mm (19") mounting angles.
- 482.6 mm (19") mounting cut-outs integrated within the partitioning areas may optionally be sealed with the supplied blanking panels, or used to install additional components or for cable routing. Please see the product-specific scope of supply.

Accessories:

- 482.6 mm (19") fastener, 1 U, see page 1097



For enclosure width mm	For enclosure height mm	Product-specific scope of supply	Packs of	Model No.
600	1200	–	1 pc(s).	5302.010
800	1200	4 blanking panels, 482.6 mm (19"), 1 U	1 pc(s).	5302.011
600	1800	–	1 pc(s).	5302.012
800	1800	6 blanking panels, 482.6 mm (19"), 1 U	1 pc(s).	5302.013
600	2000	–	1 pc(s).	5302.016
800	2000	6 blanking panels, 482.6 mm (19"), 1 U	1 pc(s).	5302.014
600	2200	–	1 pc(s).	5302.017
800	2200	6 blanking panels, 482.6 mm (19"), 1 U	1 pc(s).	5302.015

482.6 mm (19") installation system

482.6 mm (19") installation

Air baffle plate

for VX IT 482.6 mm (19") mounting angles, dynamic

For selectively boosting the energy efficiency of a climate control system.

Applications:

- To separate the hot/cold zones within an enclosure with aisle containment or when using an LCP system.

Benefits:

- Vertical brush strip for collision-free shielding with installed rail systems on the outer mounting level

Material:

- Sheet steel
- Blanking panel: Plastic, UL 94-HB, halogen-free
- Brush strip: Plastic, UL 94-HB

Surface finish:

- Spray-finished

Colour:

- RAL 9005

Supply includes:

- 2 vertical trim panels
- 2 horizontal trim panels
- 4 brush strips
- 4 cellular PU foam pieces
- Assembly parts



Assembly instruction:

- The vertical trim panels with brush strip may be fitted on both the front and rear 482.6 mm (19") mounting angles for partitioning.
- The horizontal trim panels with brush strips can only be mounted on the front 482.6 mm (19") mounting angles.
- 482.6 mm (19") mounting cut-outs integrated within the partitioning areas may optionally be sealed with the supplied blanking panels, or used to install additional components or for cable routing. Please see the product-specific scope of supply.



Accessories:

- 482.6 mm (19") fastener, 1 U, see page 1097



For enclosure width mm	For enclosure height mm	Product-specific scope of supply	Packs of	Model No.
600	1200	-	1 pc(s).	5302.000
800	1200	4 blanking panels, 482.6 mm (19"), 1 U	1 pc(s).	5302.001
600	1800	-	1 pc(s).	5302.002
800	1800	6 blanking panels, 482.6 mm (19"), 1 U	1 pc(s).	5302.003
600	2000	-	1 pc(s).	5302.004
800	2000	6 blanking panels, 482.6 mm (19"), 1 U	1 pc(s).	5302.005
600	2200	-	1 pc(s).	5302.006
800	2200	6 blanking panels, 482.6 mm (19"), 1 U	1 pc(s).	5302.007
600	2450	-	1 pc(s).	5302.008
800	2450	6 blanking panels, 482.6 mm (19"), 1 U	1 pc(s).	5302.009

482.6 mm (19") air duct

for horizontal air routing

Air duct, passive, for cold air supply to 482.6 mm (19") IT equipment installed at the rear of server racks; air is drawn in from the front.

Benefits:

- For superior air infeed to the rear 482.6 mm (19") components
- Integral brush strip for cable entry of 482.6 mm (19") IT equipment
- Supports front-to-back air routing
- Depth-variable

Material:

- Sheet steel, spray-finished
- Brush strip: Plastic, UL 94-HB

Colour:

- RAL 9005

Width mm	Height U	Depth mm	Packs of	Model No.
482.6	1	223 - 356	1 pc(s).	3301.391

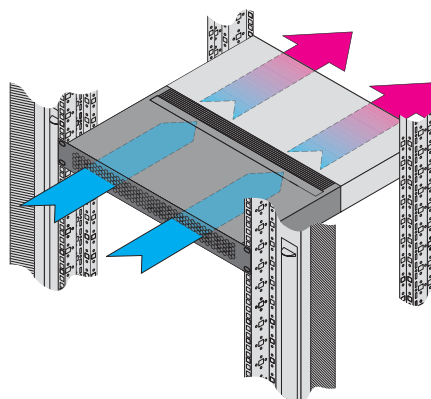

482.6 mm (19") installation system

482.6 mm (19") installation



Air duct

for side air routing

Air duct, passive, for cold air intake to 482.6 mm (19") IT equipment with side air inlet. Suitable for use in conjunction with all-round partitioning around the mounting level via air baffle plates and targeted management of the airflow through the air duct.

Benefits:

- For superior air infeed to the rear 482.6 mm (19") equipment with side air routing
- Integral membrane cover allows cable entry to the rear
- Depth-variable

Installation options:

- for 482.6 mm (19") mounting angles, standard

Material:

- Sheet steel

Surface finish:

- Spray-finished

Colour:

- RAL 9005

Supply includes:

- Air duct
- Adaptor for attaching to 482.6 mm (19") mounting angles
- Magnetic strip to cover the remaining vertical openings in the air baffle plate

Height U	Depth mm	For enclosure width mm	Packs of	Model No.
2	275 - 418	800	1 pc(s).	3301.392



Also required:

- Air baffle plate, see page 1094



Assembly instruction:

- Only suitable for fitting on the front 482.6 mm (19") installation level
- Can only be mounted in the area of the vertical 19" openings of the air baffle plate

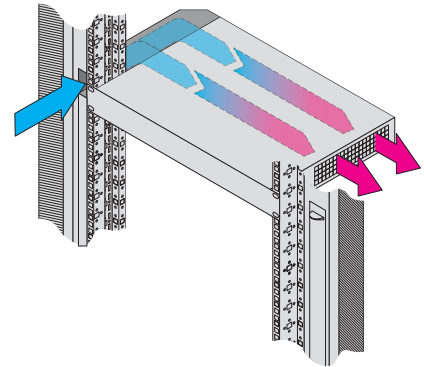

Brush strip, vertical

for VX IT

Within the network distributor, this serves as a flexible infill panel which stylishly conceals the cable management area to the side of the 482.6 mm (19") mounting level. The brush strip facilitates convenient cable routing from the side and rear distributor area to the front connection level. The clearance required in front of the mounting level is at least 75 mm. The brush strip is mounted at the side on the vertical frame section, on horizontal or vertical punched sections.

Material:

- Aluminium section, natural anodised
- Brush strip: Plastic, UL 94-HB

Length mm	Bristle length mm	For enclosure height mm	Packs of	Model No.
950	95	2000	4 pc(s).	7827.544



Assembly instruction:

- The brush strip will need to be shortened when mounting on 482.6 mm (19") mounting angles.

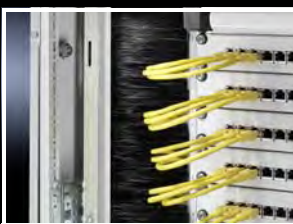

482.6 mm (19") installation system

482.6 mm (19") installation

Mounting panel, 482.6 mm (19")

For fast integration of smaller mounting units within the 482.6 mm (19") level, such as potential equalisation rails, distributor boxes, small electrical components etc. Simple screw-fastening of the components to the integral 25 mm system punchings.

Material:

- Sheet steel



Also required:

- 482.6 mm (19") fastener, 1 U, see page 1097
- Multi-tooth screws, see page 1098



Accessories:

- 482.6 mm (19") fastener, 1 U, see page 1097

Units U	Mounting surface width mm	Colour	Surface finish	Packs of	Model No.
2	450	-	Zinc-plated	1 pc(s).	7151.300
1	450	RAL 9005	Spray-finished	1 pc(s).	5302.204



Support

for small appliances

For secure attachment of non-482.6 mm (19")-conforming small appliances such as modems, power packs, routers etc. Angular support for mounting in the free space at the side between the 482.6 mm (19") level and the side panel on mounting angles or punched sections. Attachment of the components and connection cables can be achieved quickly and easily using nylon tape or cable ties. Also suitable for cable routing in the enclosure depth.

Height mm	Width mm	Depth mm	Packs of	Model No.
150	350	97	1 pc(s).	7246.500

Material:

- Sheet steel

Surface finish:

- Zinc-plated

Supply includes:

- Assembly parts



482.6 mm (19") fastener, 1 U

with contact

For simple screw connection of installation components within the 482.6 mm (19") mounting level. Simply slide onto the mounting angle from the inside and lock home.

Benefits:

- Fast positioning and installation instead of using individual cage nuts
- Integral contacting for potential equalisation
- Preconfigured 1 U support with 3 cage nuts, including centre attachment to standard EIA 310
- Supports multiple dismantling and reuse

Material:

- Sheet steel

Surface finish:

- Zinc-plated

Thread	Packs of	Model No.
M5	24 pc(s).	2090.000

Note:

- All enclosures in the Rittal range have already been tested within their tolerances for the use of 482.6 mm (19") fasteners. Suitability for use in enclosures from other manufacturers cannot be guaranteed.



Also required:

- Multi-tooth screws, see page 1098



482.6 mm (19") installation system

482.6 mm (19") installation



Captive nuts

For the attachment of rack-mounted electronic equipment, 482.6 mm (19") installed equipment and blanking plates to mounting angles, 482.6 mm (19"). For use with metal thickness from 0.8 – 2.5 mm. Optionally with or without contact of the installed equipment to the 482.6 mm (19") section/enclosure.

Thread	Design	For metal thickness mm	Packs of	Model No.
M5	without contact	0.8 - 2.5	50 pc(s).	2092.500
M5	with contact	0.8 - 2.5	50 pc(s).	2094.500
M6	without contact	0.8 - 2.5	50 pc(s).	2092.200
M6	with contact	0.8 - 2.5	50 pc(s).	2094.200

Possible alternative:

- 482.6 mm (19") fastener, 1 U, see page 1097

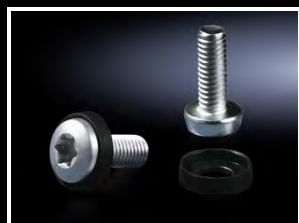

Assembly screws

For electronic equipment, 482.6 mm (19") installed components and blanking plates.

Supply includes:

- Plastic washers

Thread	Thread length mm	Design	Packs of	Model No.
M5	16	Phillips-head screw	50 pc(s).	7094.120
M5	16	Multi-tooth 25	50 pc(s).	7094.130
M6	16	Phillips-head screw	50 pc(s).	7094.100
M6	16	Slot-head screw	50 pc(s).	7094.110
M6	16	Multi-tooth 30	50 pc(s).	7094.140

Assembly instruction:

- Max. tightening torque 3 Nm



Front-mounting cage nut, 482.6 mm (19")

The cage nut consists of an expanding nut which is simply inserted into the square attachment hole at the front and then secured with the assembly screw. When tightening the screw, the cage expands and thus secures the required components. Clamping range from 1.2 – 4.5 mm. Multi-tooth screw head, bit size T 30.

Material:

- Sheet steel

Surface finish:

- Zinc-plated

Supply includes:

- Pan-head screws
- Expanding nuts
- Plastic washers

Thread	Thread length mm	Design	Packs of	Model No.
M6	16	Size of mounting hole 9.5 x 9.5 mm	50 pc(s).	2094.400



482.6 mm (19") installation system

482.6 mm (19") installation

Spring nuts with screws

for T-slot mounting angle

The spring nuts ensure flexible, secure mounting of accessory components on the T-slot mounting angles.

Supply includes:

- Spring nuts
- Screws, self-locking

Thread	Thread length mm	Design	Packs of	Model No.
M6	10	Phillips-head screw	50 pc(s).	7000.990



Fibre-optic splicing box, depth-variable

The 482.6 mm (19") splicing box is designed to accommodate splicing cassettes and can be installed in any network distributor with 482.6 mm (19") accommodation and used as a fibre-optic termination or distributor. The variable cassette fixture permits twist-proof installation of all standard splicing cassettes. The rear section of the splicing box is completely open for cable entry; a rubber cable clamp strip provides protection against dust. The fibre-optic cables can be secured with cable ties or cable clamps. The splicing box is infinitely depth-adjustable up to 100 mm within the 482.6 mm (19") flanges. In addition, the splicing box may be fully withdrawn from the 482.6 mm (19") flanges. Two strain relief clips and cable routing clips for the fibre stock provide a solution to suit any fibre-optic wiring system.

Material:

- Sheet steel

Colour:

- RAL 7035

Supply includes:

- Splicing box
- Cable routing clips
- Cassette cover
- Mounting accessories for patch panel

Note:

- Supplied without patch panels and splicing cassettes

Units U	Maximum no. of splicing cassettes	Installation depth mm	Packs of	Model No.
1	2	302	1 pc(s).	7241.005



Also required:

- Patch panels, see page 1100



482.6 mm (19") installation system

482.6 mm (19") installation

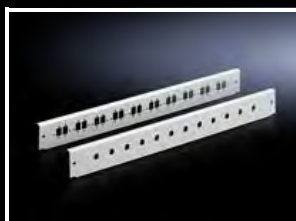

Patch panels

for fibre-optic splicing box, depth-variable, and fibre-optic breakout box, 1 U

With cut-outs for population with fibre-optic couplings.

Applications:

- for fibre-optic splicing box, depth-variable, and fibre-optic breakout box, 1 U

Material:

- Sheet steel

Colour:

- RAL 7035

Units U	For couplings	Number of locations	Packs of	Model No.
1	E-2000 E-2000 duplex SC LC duplex	24	1 pc(s).	7241.024
1	SC duplex LC quad	12	1 pc(s).	7241.045



Fibre-optic splicing box with telescopic pull-out

lockable

The 482.6 mm (19") splicing box is designed to accommodate splicing cassettes and can be installed in any network distributor with 482.6 mm (19") accommodation and used as a fibre-optic termination or distributor. The rear section of the splicing box is completely open for cable entry; a rubber cable clamp strip provides protection against dust. The fibre-optic cables can be secured with cable ties or cable clamps; two strain relief clips and cable routing clips for the fibre stock provide a solution to suit any fibre-optic wiring system.

Benefits:

- The telescopic pull-out provides optimum access to the splicing cassettes and cable clamp
- The variable cassette fixture permits twist-proof installation of all standard splicing cassettes
- The security lock fitted at the front protects against unauthorised access

Material:

- Sheet steel

Colour:

- RAL 7035

Supply includes:

- Splicing box
- Cable routing clips
- Security lock
- Cassette cover
- Mounting accessories for patch panel

Note:

- Supplied without patch panels and splicing cassettes

Units U	Maximum no. of splicing cassettes	Installation depth mm	Packs of	Model No.
1	2	363	1 pc(s).	7170.535
2	4	363	1 pc(s).	7470.535



Also required:

- Patch panel, see page 1101

482.6 mm (19") installation system

482.6 mm (19") installation

Patch panel

for fibre-optic splicing box, lockable

For splicing boxes, there is a choice of multiple panels with corresponding cut-outs for the installation of single or duplex fibre-optic couplings.

Material:

– Sheet steel

Colour:

– RAL 7035

Units U	For couplings	Number of locations	Packs of	Model No.
2	E-2000 E-2000 duplex SC LC duplex	24	1 pc(s).	7478.535
1	E-2000 E-2000 duplex SC LC LC duplex	20	1 pc(s).	7178.535
1	SC duplex LC quad	12	1 pc(s).	7169.535
2	ST	24	1 pc(s).	7474.535

Patch panels for small fibre-optic distributors

Various patch panels with different connector types are available for individual configuration of small fibre-optic distributors.

Material:

– Sheet steel

Colour:

– RAL 7035

Supply includes:

– Patch panel
– Assembly parts

For couplings	Number of locations single/duplex	Max. no. of patch panels per housing	Packs of	Model No.
ST	12	2	2 pc(s).	7462.000
SC E-2000 E-2000 duplex	12 / 6	2	2 pc(s).	7463.100
SC duplex	6	2	2 pc(s).	7463.200

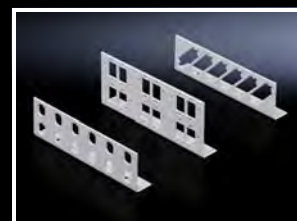

482.6 mm (19") installation system

LSA connection system



Support unit, 3 U

for LSA-Plus strips, max. 150 paired wires

To accommodate a maximum of 15 LSA-Plus strips (each with 10 paired wires). 3 x 5 LSA-Plus connection strips 2/10, series 2, may be installed horizontally. Strip length 124 mm, height pitch pattern 22.5 mm. The support unit may be integrated in all 482.6 mm (19") mounting levels. The mounting level is recessed 75 mm behind the 482.6 mm (19") flanges. Integral shunting rings enable tidy routing and distribution of the telecommunication cables.

Material:

- Stainless steel

Supply includes:

- Support unit, 8 shunting rings

Units U	Model No.
3	7050.100



Accommodation system, 2 U

for LSA installation kit

To accommodate LSA support systems within the 482.6 mm (19") mounting level.

Material:

- Sheet steel

Surface finish:

- Spray-finished

Colour:

- RAL 7035

Supply includes:

- Assembly parts

Units U	Depth mm	Packs of	Model No.
2	98.5	2 pc(s).	7050.035



Handle set

for Comfort Panel

For external mounting on corner pieces, also suitable for retro-fitting.

Material:

- Handle tube: Aluminium
- Handle holder: Die-cast zinc
- Covers: Polyamide

Surface finish:

- Handle tube: Natural anodised
- Handle holder: Powder-coated

Colour:

- Handle holder: RAL 7024
- Covers: Similar to RAL 7024

Supply includes:

- Handle tube, Ø 20 mm
- 2 handle holders
- 2 covers
- Assembly parts

For horizontal mounting

With front panel width	Packs of	Model No.
482.6 mm (19")	1 pc(s).	6375.010

Note:

- Shorter heights and widths can be achieved by cutting the handle tube to length
- For enclosures with 74 mm installation depth, cannot be mounted on the same side as the support arm connection



Accessories:

- Clipboard, see page 1106
- Display board, see page 1106

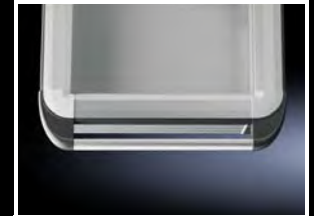

Handle set

for Optipanel

For external mounting on corner pieces, also suitable for retro-fitting.

Material:

- Handle tube: Aluminium
- Handle holder: Die-cast zinc
- Covers: Polyamide

Surface finish:

- Handle tube: Natural anodised
- Handle holder: Powder-coated

Colour:

- Handle holder: RAL 7035
- Covers: RAL 7024

Supply includes:

- Handle tube, Ø 25 mm
- 2 handle holders
- 2 covers
- Assembly parts

For horizontal mounting

With front panel width	Packs of	Model No.
482.6 mm (19")	1 pc(s).	6385.010

Note:

- Shorter heights and widths can be achieved by cutting the handle tube to length
- For enclosures with 100 mm installation depth, cannot be mounted on the same side as the support arm connection



Accessories:

- Clipboard, see page 1106
- Display board, see page 1106



Handles



Handle set

For vertical and horizontal mounting on all surfaces.

Overall length: 420 mm

Material:

- Handle tube: Aluminium
- Tube holder: Die-cast zinc

Surface finish:

- Handle tube: Natural anodised

Colour:

- Tube holder: RAL 7035

Supply includes:

- 4 tube holders
- 2 handle tubes

Packs of	Model No.
1 pc(s).	2389.000



Accessories:

- Clipboard, see page 1106
- Display board, see page 1106



TP aluminium strip

For retrofitting externally on:

- TP three-part/two-part
- TP one-piece console
- May be mounted on all enclosures/covers with 20 mm fold height (max. metal thickness 2 mm)

Length: 1750 mm (easily cut to length for other dimensions)

Sufficient for desk sections and consoles:

- 3 x width 600 mm
- 2 x width 800 mm
- 1 x width 1000 mm + 1 x width 600 mm
- 1 x width 1200 mm
- 1 x width 1600 mm

Length mm	Model No.
1750	6731.120

Material:

- Aluminium strip: Extruded aluminium section
- Cover caps: Plastic

Surface finish:

- Aluminium strip: Natural anodised

Colour:

- Cover caps: RAL 7035

Supply includes:

- 1 aluminium section
- 6 plastic cover caps
- Drilling template
- Assembly parts

Handles

For horizontal or vertical attachment to the enclosure panel of:

- Comfort Panel
- Optipanel
- Other enclosures or
- Surfaces

Mounting holes and surfaces without fins are required for assembly purposes.

For the Comfort Panel version with fins, selectable via configurators at www.rittal.com/configurators, corresponding milling work may be carried out. To this end, please specify "Prepared for handle set 6107.XXX" for the command panel.

Material:

- Handle holder: Die-cast zinc
- Cover bungs: Plastic
- Handle tube: Aluminium

Surface finish:

- Handle tube: Powder-coated

Colour:

- Handle holder: RAL 7035
- Cover bungs: Similar to RAL 7035
- Handle tube: Similar to RAL 9006

Corner handle

Supply includes:

- 4 handle holders
- 2 handle tubes
- Assembly parts

Mounting on enclosure corner

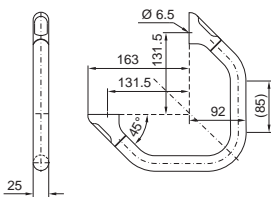

Packs of	Model No.
2 pc(s).	6107.000

External mounting on straight surface (90° rotation of handle holder)

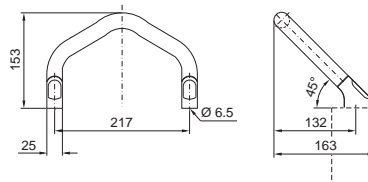

U handle

Supply includes:

- 2 handle holders
- 1 handle tube
- Assembly parts

For front panel size	Packs of	Model No.
≥ 7 U	1 pc(s).	6107.100
482.6 mm (19")	1 pc(s).	6107.200

Accessories:

- For 6107.200: Clipboard, see page 1106
- For 6107.200: Display board, see page 1106

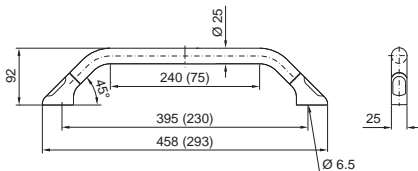

Note:

- Dimensions in brackets for front size 7 U

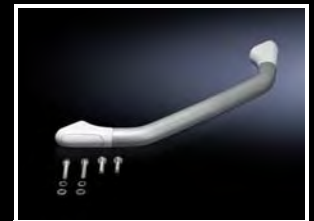

External mounting accessories



Clipboard

For securing operating instructions or plans (A4 size) at eye level. Prepared for mounting on the right-hand side; mounting on the left is also possible by unscrewing and moving the clip part. For mounting purposes, a straight tube length of ≥ 200 mm, $\varnothing 20$ mm or $\varnothing 25$ mm is required.

Material:

- Clipboard: Sheet steel
- Clip part: Aluminium

Surface finish:

- Clip part: Natural anodised

Colour:

- RAL 7035

Width mm	Height mm	Packs of	Model No.
225	315	1 pc(s).	6013.000



Also required:

- Handle set 2389.000, see page 1104 or
- Handle set for Comfort Panel, see page 1103 or
- Handle set for Optipanel, see page 1103 or
- U handle 6107.200, see page 1105

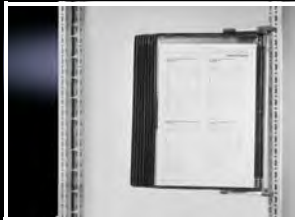

Display board

with wall bracket

To accommodate test plans, documents etc. in A4 format.

Mounting

- On surfaces
- On a 25 mm pitch pattern of the enclosure frame or rail system
- On handle set $\varnothing 20$ mm or $\varnothing 25$ mm

Supply includes:

- Display board
- Wall bracket
- Assembly parts

Packs of	Model No.
1 pc(s).	6013.100



Accessories:

- Handle set 2389.000, see page 1104 or
- Handle set for Comfort Panel, see page 1103 or
- Handle set for Optipanel, see page 1103 or
- U handle 6107.200, see page 1105

Front assembly

Front panel

for Comfort Panel and Optipanel

Material:

- Aluminium, 3 mm

Surface finish:

- Natural anodised

Note:

- Mounting kits included with the supply of 520 mm wide standard enclosures.

With threaded bolts M5

Width mm	Height mm	Model No.
482.6 (19")	155.0 (3.5 U)	6027.010
482.6 (19")	310.3 (7 U)	6028.010
520	400	6028.014
520	500	6028.015
520	600	6028.016



Also required:

- Mounting kit for Comfort Panel 6053.800, see page 1108
- Mounting kit for Optipanel 6053.000/.500, see page 1108

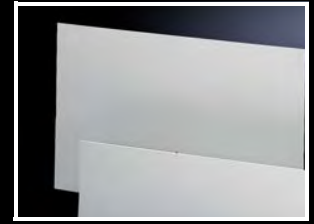

Front panel

for Compact Panel

Material:

- Aluminium, 3 mm

Surface finish:

- Natural anodised

Size W x H mm	To fit Compact Panel	Model No.
178 x 200	6340.000	6028.500
178 x 350	6340.100	6028.510
252 x 200	6340.300	6028.530
252 x 350	6340.400	6028.540

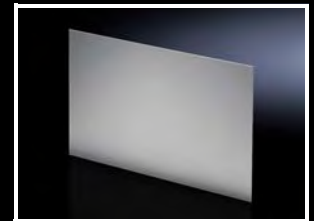

Cover plate

for support arm connection

For secure sealing of an unrequired support arm connection in the enclosure.

Material:

- Sheet steel

Supply includes:

- Seal and assembly parts

Note:

With

- Comfort Panel
- Optipanel
- Compact Panel

If there are already 2 support arm cut-outs provided, a cover plate is included with the supply of the enclosure

Support arm connection	Surface finish	Model No.
□ 90 x 71 mm	Spray finished in RAL 7024	6505.200
∅ 130 mm	Zinc-plated, passivated	6505.500
□ 120 x 65 mm	Zinc-plated, passivated	6505.100

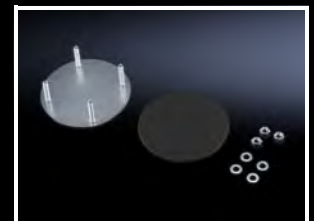

Front assembly



Mounting kit

for Optipanel

- For installation of
- Aluminium front panels
 - Command panels
 - Keyboards

for drilled holes

Supply includes:

- Packs of 30 retaining claws, cage nuts, screws and sealing washers

for threaded bolts

Supply includes:

- Packs of 10 retaining claws and cap screws

for screw clamp

Supply includes:

- Packs of 4 pressure plates, 4 attachment strips

Note:

- The command panels MP 377 12" Touch, MP 377 15" Touch are installed using an adaptor plate

For front panels	Thread	Model No.
Other	M4	6058.000
Rittal and others	M5	6053.000

For front panels	Thread	Model No.
Other	M4	6058.500
Rittal and others	M5	6053.500¹⁾

¹⁾ For the installation of TFT monitors 15", 17" and 19"

For direct installation of	Model No.
Siemens Sinumerik: OP 010, OP 010C, OP 012, OP 015, OP 019, MCP 483, PP 012, Qwerty 19", KB 483C, TP 015A	6053.210
Siemens Simatic: Panel PC 477C, 577C, 677C: 12.1"-Touch, 15.1"-Touch, 12.1"-Key, 15.1"-Key, 19"-Touch ¹⁾ , 22"-Touch ¹⁾ , Flat Panel ¹⁾ 12", 15", 19"	
Industrial Flat Panel: IFP 1200 Touch, IFP 1500 Touch, IFP 1200 Key, IFP 1500 Key, IFP 1900 Touch, IFP 2200 Touch	
Industrial Thin Client: ITC 1200, ITC 1500, ITC 1900, ITC 2200	

The mounting set can only be installed vertically
¹⁾ 2 packs are required



Mounting kit

for Comfort Panel

For the installation of aluminium front panels, command panels and keyboards.

Supply includes:

- 6053.800:
20 each of retaining claws, cage nuts, screws, nuts and sealing washers
- 6053.300:
8 medium retaining claws, 8 short retaining claws, 4 long retaining claws.

Note:

- The command panels listed are merely a reduced selection of standard units from various manufacturers which support direct installation into the Comfort Panel.

1 6053.800

2 6053.300

For drilled holes/bolts/front panel mounting from behind

Thread	Model No.
M5	6053.800

For direct installation of e.g. operating fronts, monitors, panel PCs

For installation of	Model No.
Siemens Sinumerik: OP 010, OP 010 C, OP 012, OP 015, OP 015 A, OP 019, MCP 483 C, MCP 483, PP 012, PP 012 Erweiterung, MCP, KB 483 C, Qwerty 19"	6053.300
Siemens Simatic: TP 1500 Comfort, TP 1900 Comfort, TP 2200 Comfort, KP 900 Comfort, KP 1200 Comfort, KTP 1000 Basic, KTP 1500 Basic	
Panel PC 477C, 577C, 677C: 12.1" Key, 12.1" Touch, 15.1" Key, 15.1" Touch, 19" Touch, 22" Touch ¹⁾	
MP 377 12" Touch, MP 377 15" Touch, MP 377 19" Touch	
Industrial Flat Panel: IFP 1200 Touch, IFP 1500 Touch, IFP 1200 Key, IFP 1500 Key, IFP 1900 Touch, IFP 2200 Touch	
Industrial Thin Client: ITC 1200, ITC 1500, ITC 1900, ITC 2200	
B & R: Automation Panel, Panel PC	

¹⁾ 2 packs are required

TFT monitor

Installation variant for surfaces and command panels.

Benefits:

- High-quality industrial design
- Reduced installation work thanks to integral front frame
- No additional ventilation required
- Very small installation depth (45 mm)

Material:

- Front frame: Aluminium

Surface finish:

- Powder-coated

Colour:

- RAL 7035

Protection category IP to IEC 60 529:

- IP 65 (at the front)

Supply includes:

- Seal, hex nuts (for installation in surfaces), VGA cables, threaded bolts M5 for rear mounting.
- Touch variants additionally with integral connection cable and driver CD-ROM.

Size	Width mm	Height mm	Model No.	
			Touch	
			Without ¹⁾	resistive, USB
15"	430	343	6450.010	6450.070
17"	482.6	354.8	6450.020	-
19"	482.6	399.3	6450.170	-

¹⁾ With anti-reflection coated safety glass screen

Note:

- Other variants as resistive touchscreen with serial or USB interface are also possible



Also required:

- Mounting kit 6053.800 (when installing in Comfort Panel), see page 1108
- Mounting kit 6053.500 (when installing in Optipanel), see page 1108
- Power pack 6450.050, see page 1109 and
- Connection cable 6450.060, see page 1109

Technical specifications	15"	17"	19"
Resolution of display (max. pixels)	1024 x 768	1280 x 1024	1280 x 1024
Resolution of controller/million colours	VGA-XGA/16.7 ¹⁾	VGA-SXGA/16.7	VGA-SXGA/16.7
Brightness cd/m ²	400	350	350
Contrast ratio	700:1	1000:1	1000:1
H-Sync. kHz/V-Sync. Hz	31.4 – 80/60 – 75	31.4 – 80/60 – 75	31.5 – 80/60 – 75
Reading angle horizontal (right/left)	80°/80°	85°/85°	85°/85°
Reading angle vertical (top/bottom)	70°/70°	80°/80°	85°/85°
Backlight/operating time h	LED/min. 50000		
On-screen display (OSD)	Operating buttons on the rear		
VGA input/DVI-D	VGA (D-SUB HD 15-pole)/DVI-D jack		
Rated voltage V (DC)	12		
Power consumption (W)	15	20	20
Operating temperature/storage temperature	0 °C...+50 °C/ -40 °C...+85 °C	0 °C...+50 °C/ -30 °C...+85 °C	0 °C...+50 °C/ -20 °C...+60 °C
Max. humidity during operation and storage, non-condensing	90% relative humidity for 240 h	80% rel. humidity for 300 h at 50 °C	80 % relative humidity

¹⁾ For 6450.070: 16.2

Power pack

for TFT monitor

- With IEC 60 320 connector C14 for C13 connection
- Integral cable (1.5 m) for connecting to the TFT monitor

Dimensions, W x H x D: 112 x 31 x 47 mm

Technical specifications:

- Input voltage: 100 – 240 V
- Output voltage: 12 V (DC)
- Operating temperature: +10 °C...+40 °C
- Storage temperature: -10 °C...+80 °C

Packs of	Model No.
1 pc(s).	6450.050

Material:

- Enclosure: Plastic

Connection cable

for power pack

With IEC 320 socket C13 at one end for C14 connectors.

Length: 1.5 m

Packs of	Model No.
1 pc(s).	6450.060



Keyboards, supports and drawers

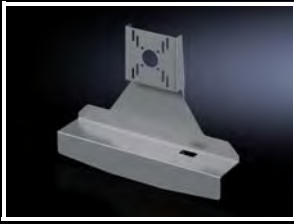

TFT holder

Suitable for mounting TFTs with VESA 75/100 adaptation up to 21" on

- Attachment CP 40, 6501.070, see page 187
- Attachment CP 60 for support arm connection
 - 120 x 65 mm, 6206.360, see page 195
- Vertical support arm via tilting adaptor +100°/-60°, 6206.460, see page 209

Material:

- Sheet steel

Surface finish:

- Spray-finished

Colour:

- RAL 7024

Dimensions mm	Packs of	Model No.
477 x 372 x 110.5	1 pc(s).	2383.030

Keyboard, pull-out

with integral trackball

Super-slimline keyboard with cursor keys and trackball. The handle also serves as a hand rest. The 10° angled pullout ensures ergonomic working.

For installation in:

- Any sufficiently large surface (e.g. door, side panel)
- Front panels
- Directly in a suitably sized Comfort Panel and Optipanel, selectable via configurators at www.rittal.com/configurators

Technical specifications:

Keyboard:

- 84 short-stroke keys, IBM-AT compatible (MF2), incl. cursor keys
- With integral trackball
- Interface: 2 x USB
- Operating temperature: +5 °C...+50 °C
- Storage temperature: -10 °C...+60 °C
- Humidity: max. 95 % (non-condensing)

Keyboard layout	Packs of	Model No.
German	1 pc(s).	6002.130

Material:

- Sheet steel

Surface finish:

- Front panel: Powder-coated

Colour:

- RAL 7035

Protection category IP to IEC 60 529:

- IP 65 (at the front, sealed)

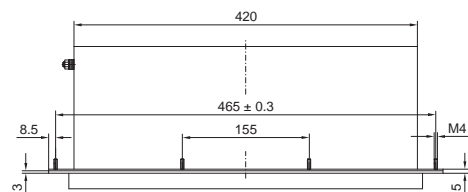
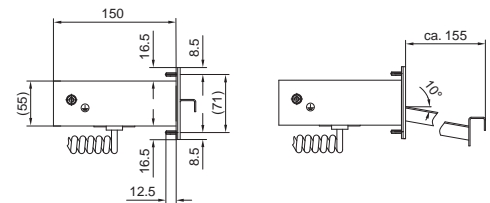
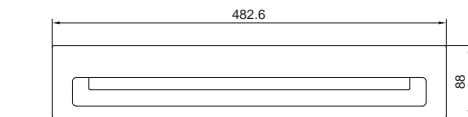

Mounting cut-out

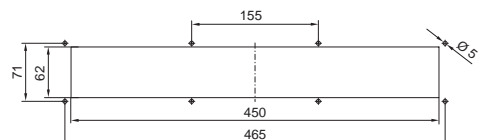

Keyboards, supports and drawers

Built-in keyboard 482.6 mm (19")/4 U

with integral touchpad

The integral touchpad eliminates the need to install an additional, correct protection category mouse, which in turn reduces cabling. The short stroke keys are easily identified by edge embossing, less force is required to operate them, and they have a good tactile action

Benefits:

- The separate number pad enables the parameters to be entered quickly
- Sealed, wipeable surface finish
- High level of mechanical and chemical resistance as per DIN 42 115.

Technical specifications:

- Number of keys: 105
- Front panel dimensions: 482.6 x 177.0 mm (19" x 4 U)
- Keyboard depth: 30 mm
- Installation depth: 27 mm
- 12 M5 x 20 threaded bolts at the rear
- Actuation travel/force: 0.3 mm/2.6 N
- Service life: 3 million switching cycles
- Operating temperature: -40 °C...+90 °C
- Touchpad resolution, capacitive: 40 pixels/mm
- Interface: USB

Material:

- Front panel: Aluminium

Protection category IP to IEC 60 529:

- IP 65 (at the front)

Supply includes:

- USB connection cable, length 1.8 m
- Seal
- Drilling template
- Assembly parts for surfaces

Keyboard layout	Packs of	Model No.
German	1 pc(s).	6446.030

! Also required:

- Mounting kit 6053.800 (when installing in Comfort Panel), see page 1108
- Mounting kit 6053.500 (when installing in Optipanel), see page 1108

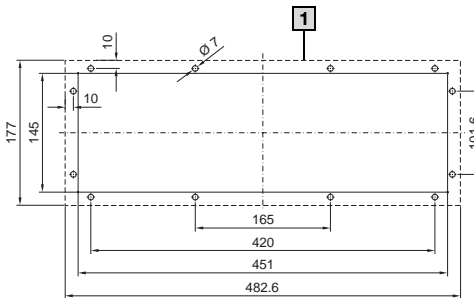

1 Support surface



Fold-out tray

for keyboard and mouse

For installation in

- 600 and 800 mm wide doors
- 482.6 mm (19") swing frames and enclosures

Standard double-bit lock insert may be exchanged for 41 mm lock inserts, type C, see page 941

Material:

- Flap: Sheet steel
- Side parts: Cast aluminium
- Tray: Extruded aluminium section
- Double-bit lock insert: Stainless steel

Surface finish:

- Flap, side parts: Textured paint
- Tray: Natural anodised

Colour:

- Flap, side parts: RAL 7035

Protection category IP to IEC 60 529:

- IP 55

Protection category NEMA:

- NEMA 12

+ Accessories:

- Mousepad support, pull-out, see page 1112

Mounting cut-out

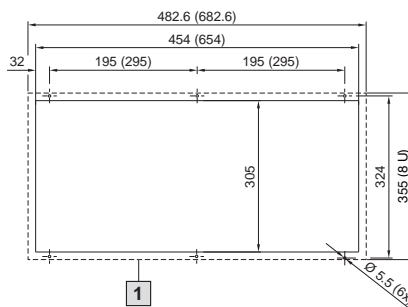

1 Support surface



For door width mm	External dimensions W x H x D mm	Installation depth mm	Max. keyboard dimensions W x H x D mm	Model No.
600	482.6 (19") x 355 (8 U) x 126	93	405 x 45 x 245 405 x 45 x 190 ¹⁾	2379.600
800	682.6 x 355 (8 U) x 126	93	605 x 45 x 245 605 x 45 x 190 ¹⁾ 475 ¹⁾ x 45 x 245	2379.800

¹⁾ Maximum keyboard size with holder for mouse

Keyboards, supports and drawers



Support for mousepad, pull-out with mouse holder

For screw-fastening into the fold-out tray 2379.600/2379.800, see page 1111. To fit all standard mousepads up to 250 x 205 mm.

Colour:

- RAL 7035

Supply includes:

- Assembly parts

Packs of	Model No.
1 pc(s).	2379.900



Utility bar, vertically hinged

To support standard keyboards during programming and servicing work. Mounting distance of utility bars for problem-free insertion: at least 300 mm. Depth adequate for keyboards up to max. 210 mm.

For mounting beneath

- Comfort Panel¹⁾
- Optipanel²⁾
- Any sufficiently large surface, such as:
 - Worktops IW
 - Command panel AX with handle strips

on

- Vertical surfaces (doors/side panels)

Min. front panel width

¹⁾ 385 mm

²⁾ 405 mm

After use, the utility bars fit securely and neatly under the mounting surface, thus giving the operator more space to move around.

Packs of	Model No.
2 pc(s).	6514.200

Material:

- Sheet steel

Surface finish:

- Zinc-plated

Supply includes:

- Assembly parts



Keyboards, supports and drawers

Drawer 482.6 mm (19")/2 U for keyboard and mouse

For installation in:

- Any sufficiently large surface (e.g. door, side panel)
- 482.6 mm (19") system punchings
- Front panels
- Directly in a suitably sized Comfort Panel and Optipanel, selectable via configurators at www.rittal.com/configurators

Suitable for

- Accommodation of keyboards up to max. 390 x 32 x 139 mm
- Support of standard commercially-available mouse or trackball

Version:

- Drawer: With stay
- Front panel: With security lock (lock no. 12321) and handle strip

Width mm	U	Depth mm	Model No.
482.6 (19")	2	150	6002.000

Material:

- Drawer housing: Sheet steel
- Drawer and front panel: Aluminium

Surface finish:

- Drawer housing: Zinc-plated
- Drawer and front panel: Natural anodised

Protection category IP to IEC 60 529:

- IP 54

Supply includes:

- Assembly parts for installation in Comfort Panel/Optipanel command panels

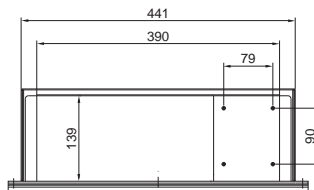
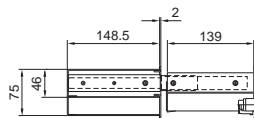
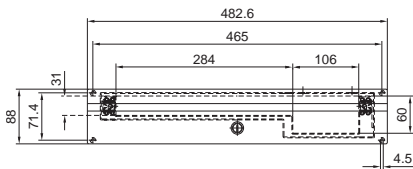
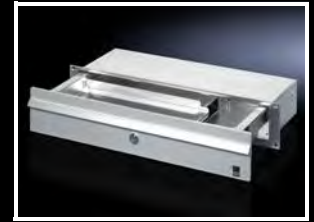

Mounting cut-out
(for installation in surfaces)

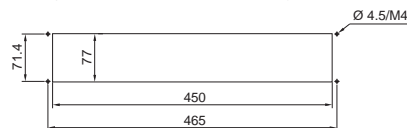

Keyboards, supports and drawers



Drawer for keyboard and mouse

with mousepad support

For installation in:

- Any sufficiently large surface (e.g. door, side panel)
- Front panels

Suitable for accommodating

- Keyboards up to a maximum of 460 x 42 x 170 mm
- Standard mouse and mousepad

Version:

- Drawer and housing: With side pull-out mousepad support and tray
- Front panel: With 3 mm double-bit lock insert, folds out as handrest

Packs of	Model No.
1 pc(s).	6003.000

Material:

- Drawer and housing: Sheet steel
- Front panel: Aluminium

Surface finish:

- Drawer and housing: Spray-finished
- Front panel: Natural anodised

Protection category IP to IEC 60 529:

- IP 54

Supply includes:

- Assembly parts



Accessories:

- Standard double-bit lock insert may be exchanged for 27 mm lock inserts, type A, see page 941

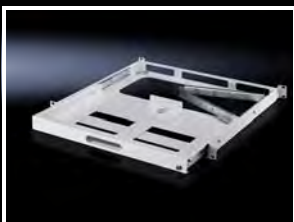
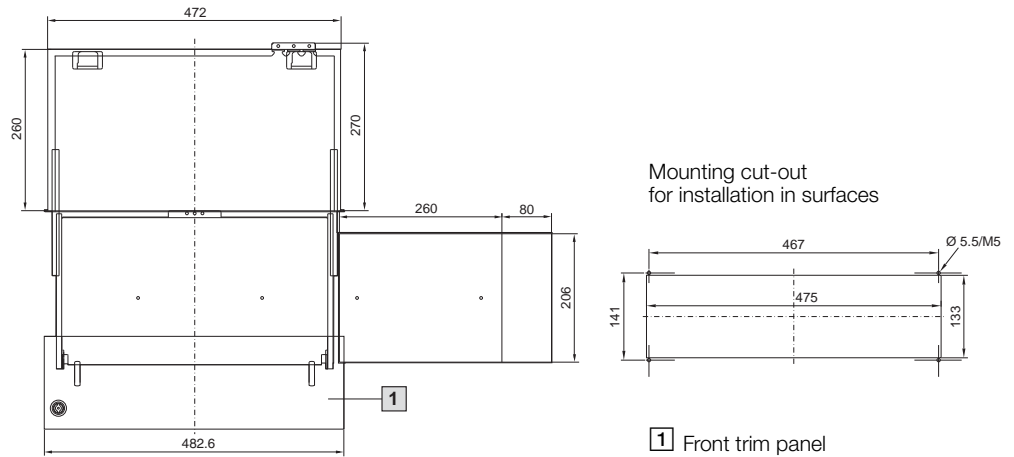

Keyboard drawer 1 U

for two 482.6 mm (19") mounting levels

This space-saving keyboard drawer is screw-fastened to the front and rear 482.6 mm (19") mounting angles. The installation spacing is infinitely adjustable from 460 – 750 mm. It is fully extendible, lockable, with strain relief and hinged cable support. The drawer is suitable for accommodating 482.6 mm (19") keyboards.

Interior dimensions:

- W x H x D: approx. 420 x 40 x 220 mm

Material:

- Sheet steel

Colour:

- RAL 7035

Supply includes:

- Assembly parts, excluding keyboard

Note:

- Monitor/keyboard unit, 1 U, see page 822

Distance between levels mm	Model No.
460 – 750	7281.200

Keyboards, supports and drawers

Keyboard drawer 2 U

for one 482.6 mm (19") mounting level

For keyboards up to 430 mm wide and 250 mm deep with the front panel folded over.

Height: 2 U

Material:

- Sheet steel with aluminium front

Surface finish:

- Spray-finished

Supply includes:

- Lockable drawer with handles
- Folding front
- Pull-out mousepad
- Mouse support
- Practical cable entry and strain relief

Colour	Packs of	Model No.
RAL 7035	1 pc(s).	7281.035
RAL 9005	1 pc(s).	5302.205

Installation depth: 390 mm

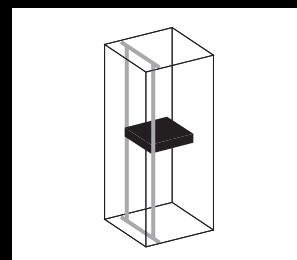

Support for mousepad

for command panels and surfaces

The angle of the mousepad support is individually adjustable. Two holes are needed on the enclosure for attachment purposes.

Material:

- Sheet steel

Surface finish:

- Zinc-plated

Supply includes:

- Assembly parts

Weight kg	Packs of	Model No.
1.0	1 pc(s).	2381.000



Accessories:

- Holder for mouse, see page 1116



Keyboard support

for command panels or surfaces

Benefits:

- Adjustable to different keyboard depths via a simple slide function
- Connection to command panels with support arm connection at the top or bottom
- Easily adjustable tilt angle
- Open support at the side prevents dirt from being deposited

Installation options:

- Operating housing AX with handle strips
- Operating housing AX for desktop TFT up to 24"
- External mounting on vertical surfaces and beneath horizontal surfaces

Technical specifications:

- Support surface fully depth adjustable from 128 – 228 mm

Material:

- Sheet steel
- Hand rest: Extruded aluminium section

Surface finish:

- Textured paint
- Handrest: Natural anodised

Colour:

- RAL 7035

Width mm	Weight kg	Packs of	Model No.
430	3.0	1 pc(s).	6321.010

Supply includes:

- Support fully preassembled
- Nylon tape for attaching the keyboard
- Assembly parts



Accessories:

- Mousepad support, vertically hinged, see page 1116

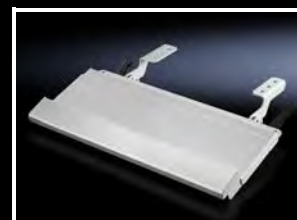
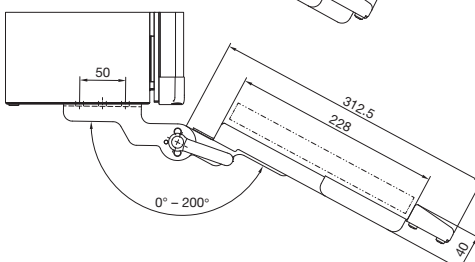
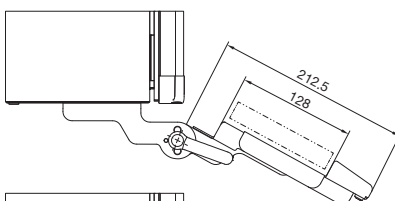

Keyboards, supports and drawers



Mousepad support, vertically hinged

For mounting on the left/right, beneath the keyboard support. Latches home automatically, both when retracted and extended. With mounting holes for holder for mouse 2382.000.

Material:

- Sheet steel

Surface finish:

- Zinc-plated

Supply includes:

- Assembly parts and mousepad, stuck on with adhesive

Packs of	Model No.
1 pc(s).	2383.020

+ Accessories:

- Holder for mouse, see page 1116

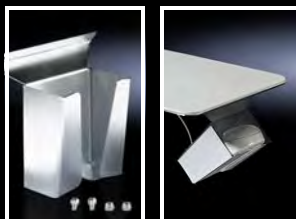
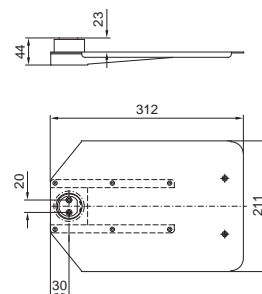

Holder for mouse

To fit mousepad support and for secure accommodation of a standard mouse.

Material:

- Sheet steel

Surface finish:

- Zinc-plated

Supply includes:

- Assembly parts

Packs of	Model No.
1 pc(s).	2382.000



Paper removal flap

For installation in surfaces

Facilitates easy removal of pages from the printer without opening the enclosure door. Acrylic glazed flap with magnetic lock.

Paper removal flap	Colour	Packs of	Model No.
A4	RAL 7015	1 pc(s).	6903.200



Base

for tubular door frame

The space-saving alternative to component shelves for accommodating tower PCs (maximum 20 kg). For screw-fastening to the tubular door frame of 600 mm wide enclosures.

Load capacity:

- 20 kg

Material:

- Sheet steel

Surface finish:

- Spray-finished

Colour:

- RAL 7015

Supply includes:

- Retaining strap and assembly parts

Width x height x depth mm	Packs of	Model No.
445 x 159 x 230	1 pc(s).	6902.950

! Also required:

- Support strip for direct screw-fastening to the tubular door frame, see page 952

Interface extension with wall connection and built-in RJ45 module

For extending the internal enclosure interfaces – e.g. of industrial PCs and switches – up to the outside of the enclosure. The wall connection only needs the same space as a switch.

Benefits:

- Rapid access for maintenance work
- The protection category of the enclosure is preserved
- The lock nut cuts automatically into the spray-finish or eloxal layer, thereby creating a conductive connection
- Captive protective cap

Material:

- Housing: Brass
- Cover: Aluminium
- Seal: Polyamide

Surface finish:

- Housing: Nickel-plated
- Cover: Natural anodised

Protection category IP to IEC 60 529:

- IP 66/67 (with protective cap closed)

Anti-twist guard

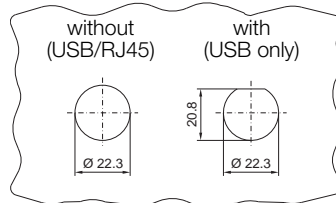

Material thickness: 1 – 6 mm

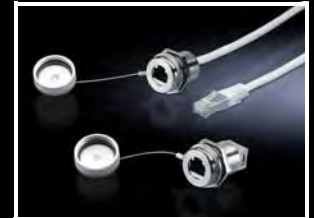

Version	Wall connection	Inside	Length m	Packs of	Model No.
USB 2.0	Type A jack	Type A connector	0.5	1 pc(s).	2482.210
			1.0	1 pc(s).	2482.220
			2.0	1 pc(s).	2482.230
RJ45	Jack	Connector	0.5	1 pc(s).	2482.700
			1.0	1 pc(s).	2482.710
			2.0	1 pc(s).	2482.720
RJ45	Jack	Jack	–	1 pc(s).	2482.730

Interface flap

for RC circuit-breakers

According to standard EN 60 204-1, all circuits with a rated current of ≤ 20 A that supply sockets in or on machine enclosures must be fused with a residual-current circuit-breaker with a rated differential current of ≤ 30 mA. Prepared for the installation of standard, 2-pole RCBO circuit-breakers.

Applications:

- As programming interface for controllers
- As maintenance access for networks
- For temporary connection of additional equipment
- For quick connection to existing network structures
- For programming and maintenance of integral components

Version:

- Spring-action terminals max. 2 x 2.5 mm, connection at rear

Benefits:

- Protection against fault currents and overload
- Standard-compliant fuse to EN 60 204
- The RC switch may be reset without opening the enclosure
- Spring mechanism raises the unlocked cover by 30°, ensuring that you do not forget to close the cover

Functions:

- A snap fastener ensures reliable sealing. This may be locked if required.

Material:

- Mounting frame: Plastic PBT (black)
- Plastic flap: Polycarbonate (semi-transparent)

Protection category IP to IEC 60 529:

- IP 65

Supply includes:

- Interface flap, complete, consisting of plastic frame, socket (VDE), RJ45 (jack/jack, Cat 5e) and cut-out for RC circuit-breaker
- Knockout provided for USB A (jack/jack)
- 3 mm double-bit with slot-in rotary knob

Note:

- Interface flap may only be used with fitted RC circuit-breaker



Width mm	Height mm	Required mounting cut-out mm	Installation depth mm	Rated operating voltage V, ~, Hz	Rated current A	Packs of	Model No.
131	127	117 x 91	70	250, 1~, 50/60	10 - 16	1 pc(s).	2482.600

Interfaces



Interface flap, modular

For universal use in all situations where rapid access to interfaces and sockets is needed. The affected enclosure remains closed and is therefore protected from ambient influences and unauthorised access.

Space-saving installation e.g.

- in **small enclosures and compact enclosures** as a programming interface for controllers
- in **IT and industrial distributors** as maintenance access for networks
- in **PC enclosures and console systems** for the temporary connection of additional equipment
- in mobile **industrial workstations** for rapid connection to existing network structures
- in **command panel systems** for programming and maintenance of integral components.

The mounting frame has a flap which snaps into position at various opening angles from 90 to 180°. A snap fastener ensures reliable sealing. This may be locked if required.

Material:

- Mounting frame and metal flap: Die-cast zinc
- Plastic flap: Polycarbonate (semi-transparent)
- Lock: Polycarbonate, RAL 7024

Surface finish:

- Mounting frame and metal flap: Matt nickel-plated

Colour:

- Lock: RAL 7024

Protection category IP to IEC 60 529:

- IP 65 (with sealed flap and proper assembly)

Description	cUR	UR	Packs of	Model No.
Mounting frame¹⁾				
1 Single, with plastic flap (semi-transparent)	–	–	1 pc(s).	2482.300
Double, with plastic flap (semi-transparent)	–	–	1 pc(s).	2482.310
2 Single, with metal flap	■	■	1 pc(s).	2482.320
3 Double, with metal flap	■	■	1 pc(s).	2482.330
Socket modules				
4 Germany (VDE), spring-action terminals max. 2 x 2.5 mm ² , connection at rear	–	–	1 pc(s).	2482.400³⁾
5 Germany (VDE), screw terminals max. 6 mm ² , connection at rear, colour: yellow (RAL 1016), for installation in front of master switch	–	–	1 pc(s).	2482.410³⁾
Interface inserts				
6 2 x SUB-D9 (jack/pin)	■	■	1 pc(s).	2482.500
7 SUB-D9 (jack/jack)	■	■	1 pc(s).	2482.510
8 2 x USB A (jack/jack)	■	■	1 pc(s).	2482.540²⁾
9 RJ45 (jack/jack, Cat. 5e), SUB-D9 (jack/jack), SUB-D9 (pin/pin)	■	■	1 pc(s).	2482.550
10 2 x RJ45 (jack/jack, Cat. 5e)	■	■	1 pc(s).	2482.560²⁾
11 USB A (jack/jack), RJ45 (jack/jack, Cat. 5e), SUB-D9 (jack/pin)	■	■	1 pc(s).	2482.570²⁾
12 Blanking plate (slimline), for individual population, usable area: 45 x 75 mm	■	■	1 pc(s).	2482.590

¹⁾ Electrically conductive

²⁾ Conductively linked to mounting frame

³⁾ Rated voltage: 250 V, Rated current: 10 – 16 A

All SUB-D interfaces may be rotated while in use

Interface flap, single

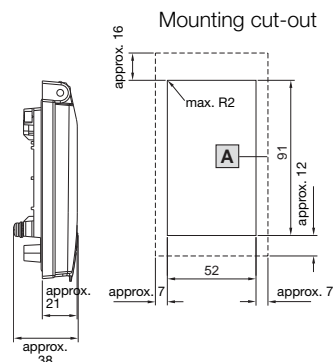
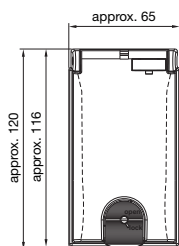

Permissible material thickness: 1 – 5 mm

A Contact surface

Interface flap, double

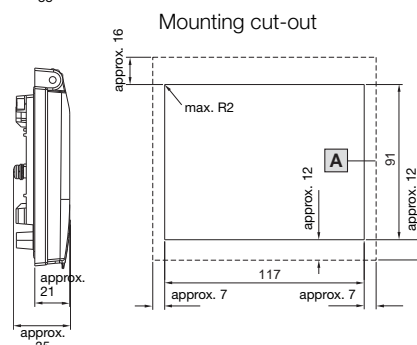
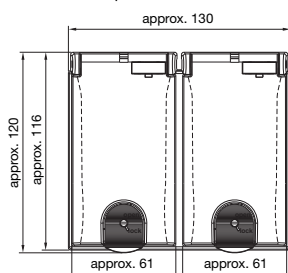

Signal pillars

For real-time display of operating statuses



Signal pillars at a glance

Plug-and-play system



Signal pillar, 3-way LED



For wall/base mounting



For conduit mounting

Model No.	
2372.102	2372.101

- 1 LED steady light component 24 V AC/DC, < 35 mA
- 2 LED steady light component 230 V, < 35 mA
- 3 LED flashing light component 24 V AC/DC
- 4 LED flashing light component 230 V
- 5 Stroboscopic light component 24 V (DC), < 35 mA
- 6 Acoustic component 24 V AC/DC, 95 – 105 dB (continuous tone or pulsating)
- 7 Acoustic component 24 V AC/DC, 102 dB (adjustable volume and choice of 8 sounds)
- 8 Acoustic component 230 V, 95 – 105 dB (continuous tone or pulsating)

- 9 Acoustic component 230 V, 102 dB (adjustable volume and choice of 8 sounds)
- 10 Mounting component for support arm system CP 40, steel – angle piece 90° 6501.140
- 11 Mounting component for support arm system CP 60 – Angle adaptor 90° for support arm combination CP 60 to CP 40 6206.640 – Angle coupling 90° 6206.380 – Angle piece 90° 6206.600 – Intermediate hinge 6206.620 – Wall-mounted hinge 6206.740 – Top-mounted joint 6206.700

- 12 Mounting component for support arm system CP 120 – Angle coupling 90° 6212.380 – Angle piece 90° 6212.600 – Intermediate hinge 6212.620 – Wall-mounted hinge 6212.740 – Top-mounted joint 6212.700
- 12 Mounting component for support arm system CP 180 – Angle piece 90° 6218.600 – Top-mounted joint 6218.700

Label panel



Model No.

2374.150

Mounting component for conduit mounting



Base with integral conduit, Ø 25 mm, 110 mm long



Individual base



Individual conduit, 250 mm long

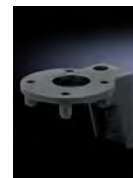

Angle bracket for conduit mounting

Model No.				
2374.000	2374.010	2374.020	2374.030	2374.050

Modular system



Optical component for signal pillar, modular

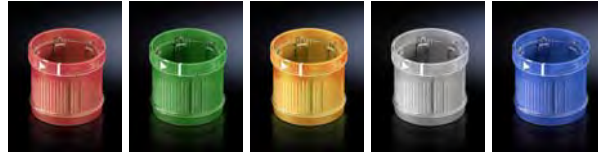

Red Green Yellow Clear Blue

	Model No.				
1	2372.001	2372.011	2372.021	2372.031	2372.041
2	2370.151	2370.161	2370.171	-	-
3	2370.501	2370.511	2370.521	2370.531	2370.541
4	2370.551	-	2370.571	-	-
5	2371.001	-	2371.021	-	-

Acoustic component



	Model No.
6	2376.001
7	2376.011
8	2376.021
9	2376.031

Connection component for signal pillar, modular



For conduit mounting



For wall/base mounting

Model No.	
2368.001	2368.002

Mounting component for support arm systems



10

11

12

Model No.

2375.030

6206.900

6212.900

Mounting component for wall/base mounting

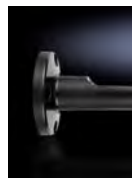

Bracket for connection component



For side cable outlet

Model No.	
2374.040	2374.080

Signal pillars



Signal pillar, 3-way LED

Benefits:

- Complete plug-and-pay solution
- Extremely long service life of the LEDs (max. 100,000 hours, therefore maintenance-free)
- Minimal assembly work and warehousing costs

Technical specifications:

- 3-stage: red, yellow and green
- Operating voltage: 24 V AC/DC
- Electrical connection: Screwless spring terminals
- Lamp: LED
- Transmission angle: 3 x 120°
- Operating temperature: -20 °C...+50 °C
- Flashing function: Controllable via PLC
- Cable entry: Metric screwed cable gland M12 x 1.5 for cable diameter 3.0 – 6.5 mm

Protection category IP to IEC 60 529:

- IP 65

Design	Packs of	H mm	Model No.
for conduit mounting	1 pc(s).	210.5	2372.101
for base mounting	1 pc(s).	212.0	2372.102

+ Accessories:

- Mounting component, see page 1125/1126
- Label panel, see page 1127

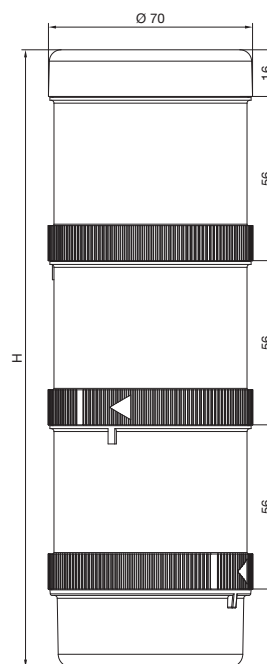

Signal pillar, modular

Benefits:

- Simple assembly and contact using bayonet fastener
- Configuration of up to five components with the same voltage
- Flashing and stroboscopic light component including lamp, for direct use
- Components available in a range of colours and voltages

For modular configuration of

- Connection components
- Optical components
- Acoustic components
- Label panel



Connection component

for signal pillar, modular

- Optionally for conduit or wall/base mounting
- Screwless spring terminals in the connection component
- With cover for optical components
- Contact hazard protection to VDE
- 12 – 230 V AC/DC

Material:

- Polyamide enclosure

Colour:

- Black

Protection category IP to IEC 60 529:

- IP 65

Connection component	Model No.
for conduit mounting	2368.001
for wall/base mounting	2368.002



Accessories:

- Mounting component, see page 1125/1126



Connection component for conduit mounting 2368.001

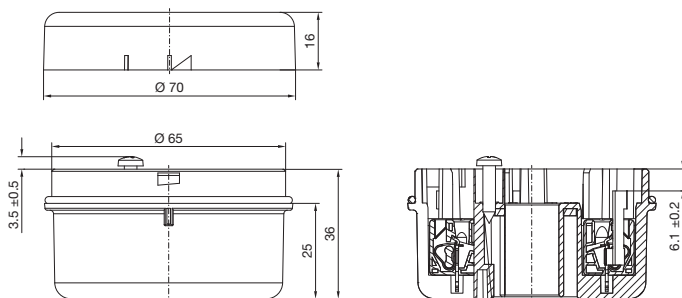

Connection component for wall/base mounting

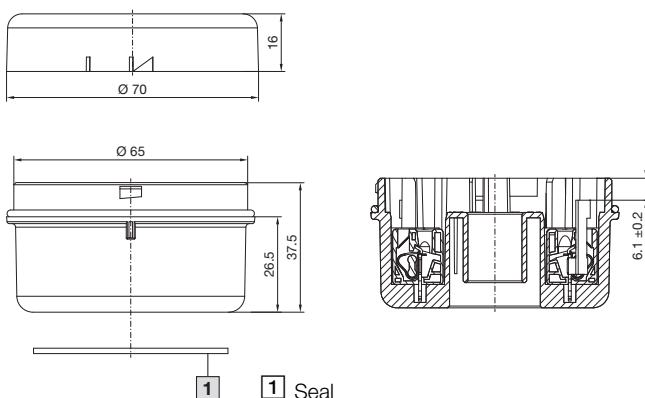

Signal pillars

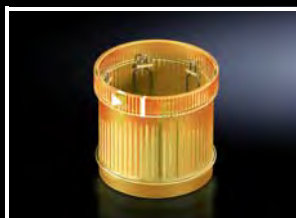

Optical component

for signal pillar, modular

- With 360° signal transmission thanks to optimised prism system
- No. of potential stages = 5 components, with identical voltage

Material:

- Enclosure: Polyamide
- Spherical cap: Transparent polycarbonate

Protection category IP to IEC 60 529:

- IP 65, provided a cover or acoustic component is fitted at the top

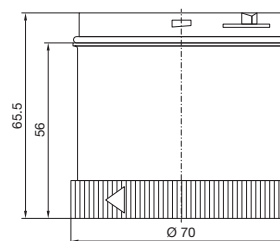

LED steady light component 24 V AC/DC, < 35 mA

Model No.				
Red	Green	Yellow	Clear	Blue
2372.001	2372.011	2372.021	2372.031	2372.041

LED steady light component 230 V, < 35 mA

Model No.				
Red	Green	Yellow	Clear	Blue
2370.151	2370.161	2370.171	-	-

LED flashing light component 24 V AC/DC, < 30 mA

Model No.				
Red	Green	Yellow	Clear	Blue
2370.501	2370.511	2370.521	2370.531	2370.541

LED flashing light component 230 V, < 35 mA

Model No.				
Red	Green	Yellow	Clear	Blue
2370.551	-	2370.571	-	-

Stroboscopic light component 24 V (DC), < 35 mA

Model No.				
Red	Green	Yellow	Clear	Blue
2371.001	-	2371.021	-	-

Mounting component for wall/base mounting

Fig.	Mounting component	Colour	Model No.
1	Bracket for connection component	Black	2374.040
2	For side cable outlet	Black	2374.080

! Also required:

- With the modular system for wall/base mounting:
Connection component 2368.002,
see page 1123

Bracket for connection component For side cable outlet

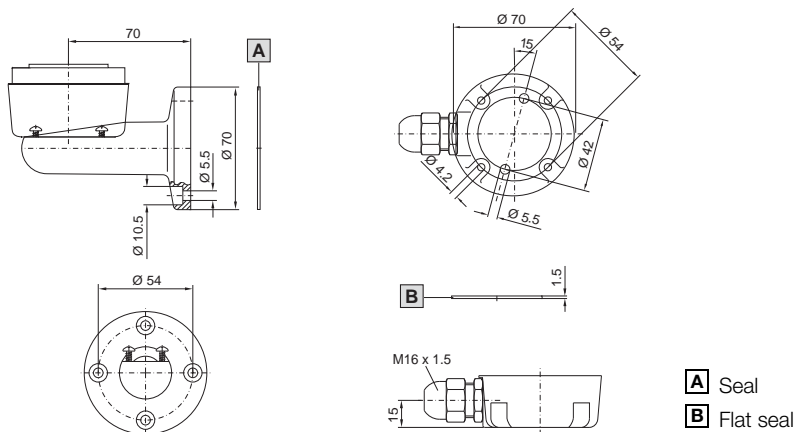

Mounting component for support arm systems

For external mounting of a signal pillar on the plastic cover of support arm components.

Fig.	Mounting component	Colour	Model No.
3	For support arm system CP 40, steel – Angle piece 90° 6501.140	RAL 7024 (graphite grey)	2375.030
4	For support arm system CP 60 – Angle adaptor 90° for support arm combination CP 60 to CP 40 6206.640 – Angle coupling 90° 6206.380 – Angle piece 90° 6206.600 – Intermediate hinge 6206.620 – Wall mounted hinge 6206.740 – Top mounted joint 6206.700	RAL 7024 (graphite grey)	6206.900
5	For support arm system CP 120 – Angle coupling 90° 6212.380 – Angle piece 90° 6212.600 – Intermediate hinge 6212.620 – Wall-mounted hinge 6212.740 – Top-mounted joint 6212.700	RAL 7024 (graphite grey)	6212.900
	For support arm system CP 180 – Angle piece 90° 6218.700, – Top-mounted joint 6218.700	RAL 7024 (graphite grey)	6212.900

! Also required:

- With the modular system for conduit mounting:
Connection component 2368.001,
see page 1123



Signal pillars

Mounting component for conduit mounting

Fig.	Mounting component	Colour	Model No.
6	Base with integral conduit, Ø 25 mm, 110 mm long	Black	2374.000
7	Individual base	Black	2374.010
8	Individual conduit, 250 mm long	Aluminium	2374.020
	Individual conduit, 400 mm long	Aluminium	2374.030
9	Angle bracket for conduit mounting	Black	2374.050

! Also required:

- With the modular system for conduit mounting:
Connection component 2368.001,
see page 1123



Base with integral conduit

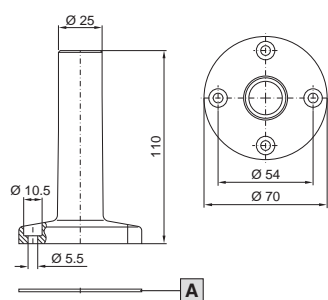

Individual conduit

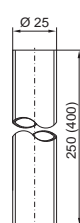

Individual base, plastic

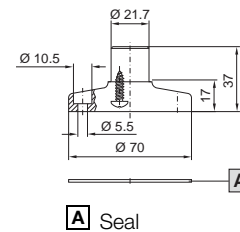

A Seal

Angle bracket for conduit mounting

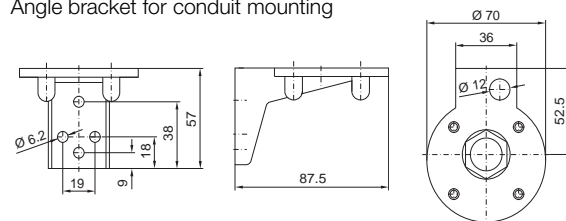

Acoustic component

for signal pillar, modular

To indicate warnings or malfunctions.

Material:

– Enclosure: Polyamide

Colour:

– Black

Protection category IP to IEC 60 529:

– IP 65

Note:

– For mounting only on the upper end of the optical components or directly onto the connection component

24 V AC/DC

Acoustic components	Packs of	Model No.
105 dB ¹⁾	1 pc(s).	2376.001
102 dB ²⁾	1 pc(s).	2376.011

¹⁾ Continuous tone or pulsating

²⁾ Adjustable volume and choice of 8 sounds

230 V

Acoustic components	Packs of	Model No.
105 dB ¹⁾	1 pc(s).	2376.021
102 dB ²⁾	1 pc(s).	2376.031

¹⁾ Continuous tone or pulsating

²⁾ Adjustable volume and choice of 8 sounds



Label panel

for signal pillar, 3-way LED and signal pillar, modular

For adding texts on up to 5 optical components, with break point for any fields that are not required (50 x 150 mm), including clamping section for base / conduit with Ø 25 mm.

Material:

– Acrylic, transparent

Label panel	Model No.
for 5 optical components	2374.150



The 3-phase coating procedure

Coating procedure	Technical properties	Technical specifications	
Surface pretreatment	Used as corrosion protection and to improve paint adhesion.	Degreasing, nanoceramic conversion layer	
Anodic dipcoat priming	Even layer formation on all surfaces, edges and in cavities, which produces a high level of corrosion protection even at the assembly stage. The primer is readily overpainted and free from heavy metals, chromate and silicone.	Erichsen cupping test to DIN EN ISO 1520	≥ 4 mm
		Buchholz hardness to DIN EN ISO 2815	≥ 80
		Cross cutting to DIN EN ISO 2409	Gt 0
Stove enamelling			
Textured powder coating	Powder-coating is distinguished by a high level of mechanical resistance, excellent corrosion protection, good resistance to chemicals and temperature, and its facility for decontamination. The powder coating is readily overpainted and is free from heavy metals, chromate, silicone and solvents.	Erichsen cupping test to DIN EN ISO 1520	≥ 3.5 mm
		Buchholz hardness to DIN EN ISO 2815	≥ 85
		Cross cutting to DIN EN ISO 2409	GT 0-1
		Salt spray test to DIN EN ISO 9227 NSS	Test period: 168 hrs
		Condensate test to DIN EN ISO 6270-2 CH	Test period: 500 hrs
		Condensate test to DIN EN ISO 6270-2 AHT	Test period: 20 cycles
Stove enamelling			

The coating is resistant to:

- Mineral oils
- Lubricants
- Machine emulsions
- Alcohol-based solvents (briefly, e.g. during cleaning)
- Weak acids and alkalines

Primer or powder coating suitable for overpainting

After careful cleaning of the surface, the standard coating may be overpainted with

- DD gloss paints
- Single and dual-component gloss paints
- Car repair paints
- Powder paints
- Water-based paints

If in doubt, perform a compatibility test. Always follow the paint manufacturer's instructions. When overpainting, take care not to exceed 180 °C and a baking time of 15 minutes.

Outdoor use of enclosures

In order to guarantee satisfactory long-term function of enclosures in outdoor use, the relevant environmental factors must be taken into account.

These include:

- UV radiation, the corrosive action of air pollution, rain, icing, snow, wind or other factors in special climatic conditions.

Condensation inside the enclosure

Condensation must be prevented by means of appropriate measures, e.g. by venting or heating the enclosure.

Protection category

The enclosure may be exposed to extreme weather conditions during outdoor use.

Long periods of rain, snow, ice, high winds and temperature fluctuations place particularly high demands on the enclosure sealing. The protection category IP X3 as envisaged for external weather conditions in DIN VDE 0100, part 737, point 5.2 is often insufficient to provide permanent protection for electrical equipment.

Protection categories to IEC 60 529 (EN 60 529)

The IP protection category is characterised by 2 numerals.

Example of a protection category, e.g. IP 43:

Code letters

IP

First numeral

4

Second numeral

3

Degrees of protection for protection against contact and foreign bodies: First numeral			Degrees of protection for protection against water: Second numeral		
First numeral	Degree of protection		Second numeral	Degree of protection	
	Description	Explanation		Description	Explanation
1	Protected against solid foreign objects with a diameter of 50 mm and greater	The object probe, a sphere 50 mm in diameter, must not penetrate fully. ¹⁾	1	Protected against vertically falling water drops	Vertically falling drops shall have no harmful effects.
2	Protected against solid foreign objects with a diameter of 12.5 mm and greater	The object probe, a sphere 12.5 mm in diameter, must not penetrate fully. ¹⁾ The articulated test finger may penetrate up to its length of 80 mm, but adequate distance from hazardous parts must be adhered to.	2	Protected against vertically falling water drops when the enclosure is tilted up to 15°	Vertically falling drops shall not have any harmful effects when the enclosure is tilted up to 15° on either side of the vertical.
3	Protected against solid foreign objects with a diameter of 2.5 mm and greater	The object probe, a sphere 2.5 mm in diameter, must not penetrate at all. ¹⁾	3	Protected against sprayed water	Water sprayed at an angle of up to 60° on either side of the vertical shall have no harmful effects.
4	Protected against solid foreign objects with a diameter of 1.0 mm and greater	The object probe, a sphere of 1.0 mm in diameter, must not penetrate at all. ¹⁾	4	Protected against splashed water	Water splashed on the enclosure from any direction shall have no harmful effects.
5	Dust-protected	The ingress of dust is not fully prevented, but dust shall not enter to such an extent as to impair satisfactory operation of the device or safety.	5	Protected against water jets	Water directed at the enclosure from any direction in a jet shall have no harmful effects.
6	Dust-tight	No ingress of dust at a partial vacuum of 20 mbar inside the enclosure.	6	Protected against powerful water jets	Water directed at the enclosure from any direction in a powerful jet shall have no harmful effects.
			7	Protected against temporary immersion in water	Water must not ingress to such an extent as to cause harmful effects when the enclosure is temporarily immersed in water under standardised pressure and time conditions.
			8	Protected against continuous immersion in water	Ingress of water in quantities causing harmful effects shall not be possible when the enclosure is continuously immersed under conditions to be agreed between the manufacturer and the user. However, the conditions must be more difficult than for numeral 7.
			9	Protected against high-pressure and high-temperature water jets	Water projected at high pressure and high temperature against the enclosure from any direction shall not have harmful effects.

¹⁾ The full diameter of the object probe must not pass through an opening of the enclosure.

Automatic potential equalisation via the mounting components (while observing DIN EN 62 208)

UL type rating

UL (Underwriters Laboratories) is an independent organisation based in Chicago which safety-tests products for the North American market. A key aspect for enclosures is the protection of individuals from unintentional contact with equipment and the protection of installed equipment from external factors. Protection categories are classified by UL type ratings.

Further information on protection categories may be found on the Internet at: www.rittal.com

UL/NEMA Type	Intended use and description
1	Enclosures for use indoors Protection against the penetration of foreign bodies
3	Enclosures for use indoors and outdoors Protection from rain, hail, dust, icing and the damage caused by icing
3R	Enclosures for use predominantly outdoors Protection from rain, hail, icing and the damage caused by icing
3S	Enclosures for use predominantly outdoors Protection from rain, hail and dust External mechanisms remain usable despite being coated in ice
4	Enclosures for indoor or outdoor use Protection against rain, foreign bodies, splashed water and hosed water and against damage caused by icing on the exterior of the enclosure
4X	Enclosures for indoor or outdoor use Protection against rain, foreign bodies, splashed water and hosed water and against damage caused by icing on the exterior of the enclosure Increased protection from corrosion
12, 12K	Enclosures for use indoors Protection against dust deposits, foreign bodies, oil and non-corrosive dripping refrigerants
13	Enclosures for use predominantly indoors Protection against dust deposits, sprayed water, oil, and non-corrosive refrigerants

The UL/NEMA classifications are not directly comparable with IP protection categories, since both the test conditions and the evaluation of the test results are different

Approvals and permits

Product certifications and approvals are pivotal to the global acceptance of industrial products.

Rittal products meet the highest internationally recognised quality yardsticks. All components are subjected to the most stringent testing in accordance with international standards and regulations.

The consistently high product quality is ensured by a comprehensive quality management system. Regular production inspections by external test institutes also guarantee compliance with global standards

A precise allocation of products to marks of conformity can be found on our product and service pages on the Internet: www.rittal.com

Earthing

The PE conductor connection must be designed by the manufacturer of switchgear in accordance with the relevant VDE and/or local regulations.

The enclosure packs generally contain earthing materials (screws, nuts, washers). The assembly instructions contain recommendations on installing a PE conductor.

The pre-assembled earth straps, available as accessories in various cross-sections and lengths, are intended to make assembly of a PE conductor easier.

Stainless steel, rust-proof

Rust-proof stainless steel is a collective term for more than 120 different types of steel, all of which are alloyed with at least 10.5% chromium and are resistant to corrosion without any protective coating. They form an invisible passive layer under the influence of oxygen.

Short name	x 5 CrNi 1810	x 2 CrNiMo 17-12-2
Material number	1.4301	1.4404
Principal property	easy to weld corrosion-resistant malleable	weldable highly corrosion-resistant
Typical uses	Foodstuffs industry Dairies	Chemical industry Construction sector Paper industry
Chemical composition/mass content in %		
Carbon C	< 0.07	< 0.07
Chromium Cr	17.5/19.5	16.5/18.5
Molybdenum Mo	-	2.0/2.5
Nickel Ni	8.0/10.5	10.0/13.0

Benefits

- Highly resistant to corrosion and chemical substances
- Outstanding hygiene properties and minimal cleaning effort, thanks to the smooth surface
- No need to treat the surface with enamel or paint
- Environmentally friendly, as 100% recyclable
- Good material properties (tensile strength, expansion, abrasion)

Rittal – The System.

Faster – better – everywhere.



CERTIFICATE OF PARTICIPATION
Issued by
UL LLC
RITTAL GMBH & CO. KG
WILHELM-BUSCH-STR. 1
42699 SOLINGEN, GERMANY
Rittal is a member of the UL Test Data Program (CTP)

ENCLOSURES

POWER DISTRIBUTION

CLIMATE CONTROL

FRIEDHELM LOH GROUP

SERVICE & QUALITY

International service

Global availability	1134
Our service portfolio	1136

Rittal Manufacturer's Service

Service for industrial applications	1140
Service for machines	1144
Service for IT infrastructure	1146

Smart Service

Smart Service – Predictive and efficient	1150
Smart Service – Bespoke and demand-driven	1152

Quality management

Quality management	1154
--------------------------	------

Software & services

Value chain	1156
Optimum value creation for all target groups	1158
Software and tools for industry	1160
Software and tools for IT infrastructure	1161



Competent. Globally present. A one-stop service.

Use our service to minimise downtimes, boost efficiency and benefit from the following advantages:

- Around 1,000 service specialists worldwide
- Highly qualified service technicians and infrastructure specialists
- Solid expert knowledge with manufacturer expertise
- Ready availability of original spare parts
- Maximum system availability
- Short response times
- Professional lifecycle management
- 24-hour availability

Whenever, wherever and however you need us, we are always on hand to assist you!

Rittal service addresses worldwide

Headquarters/Europe

Tel. +49 (0) 2772 505-1855
Email: service@rittal.de

USA

Tel.: +1 800-477-4000
Email: rittal@rittal.us

Mexico

Tel. +52 (55) 5559 5369
Email: servicemx@rittal.com.mx

Chile

Tel.: +56 (2) 2 94 77 400
Email: info@rittal.cl

Middle East

Tel.: +971 4 3416855
Email: service@rittal-middle-east.com

Singapore

Tel.: +65 6309 7315
Email: service@rittal.com.sg

India

Tel.: +91 (80) 33720783
Email: service@rittal-india.com

China

Tel. +86 800 820 0866
Email: service@rittal.cn

Your requirements

Enhanced system
availability

Cost and resource
savings



What we offer



Assembly,
installation,
commissioning



Fast
trouble-
shooting



Inspection



Professional
maintenance

International service – Global availability



Value retention
and maintenance

Rapid access
to spare parts

Modernisation



Original
spare parts



Bespoke service
agreements



Efficiency and
system advice



Individual
optimisation and
sustainability

Installation and commissioning

Correctly installed equipment is less susceptible to errors and operates more efficiently. You can be sure that the manufacturer's expertise is applied to the installation and commissioning of your Rittal components.

The benefits for you:

- Reliability from the outset
- Less susceptible to errors
- More efficient operation of your systems

Maintenance and inspection

The remaining service life of the installed components can be significantly extended with professional maintenance by the Rittal service team. This ensures efficient operation and associated cost savings. The additional inspection and leak test by certified service engineers guarantees compliance with statutory regulations, such as the F-gas regulation (EU) No. 517/2014, which in turn ensures the efficient operation of your equipment.



Visual inspection and assessment of the general condition of your equipment



Measurement and documentation of system parameters



Basic cleaning of the equipment

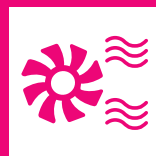

Inspection of fans, air routing and system parameters

The benefits for you:

- Downtime is prevented, to minimise your risks
- Improved value retention for your systems
- The remaining service life of installed components is extended
- Efficiency is increased by up to 30%, with associated cost savings

International service – What we offer



Repairs and troubleshooting

Rittal service engineers are continuously trained to provide top-quality, on-site troubleshooting. The result? 90% of Rittal's service deployments are resolved with just one on-site visit and include a detailed service report with further recommendations. Alternatively, you may opt to send your equipment to our factory for repair.

The benefits for you:

- Fast, professional troubleshooting
- Minimised downtimes
- Reliable service performance

Spare parts – any time, anywhere

Global availability of individual parts adds value

Professional spare parts management ensures maximum availability of spares, because optimum stocking ensures that repairs can be carried out without delay.



Original spare parts



Express shipment with 24h delivery promise (working days only)



Customer-specific stocking of spare parts, either at Rittal or at your premises

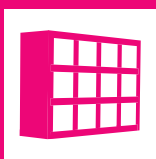

Our Global Distribution Centre has over 2,000 different standard spare parts in stock



Local availability, with stocks held by Rittal subsidiaries worldwide



Predictive replacement of worn parts thanks to professional life cycle management

Life cycle management

Knowing the age and condition of installed equipment enables predictive replacement of worn parts. This reduces downtimes and also allows you to plan costs. Here, too, you can rely on the support of Rittal's after sales service team.

International service – What we offer



Efficiency and service check

Regular checks of your Rittal components will ensure maximum performance of all cooling units while keeping consumption levels to a minimum.

During the efficiency check, Rittal will analyse your installed equipment for current performance and energy costs. Based on the findings, Rittal will advise you on potential savings and efficiency enhancements and will calculate the amortisation periods of any investments that may be required. The service check is more comprehensive than the efficiency check and includes an analysis of the current status of your equipment, highlighting any maintenance requirements, and incorporating this into your investment calculation.

The benefits for you:

- Performance analysis of installed equipment
- Presentation of energy costs and potential savings
- Reduction of unscheduled production stoppages and associated costs
- Specific energy-saving approaches
- The value of your equipment is preserved

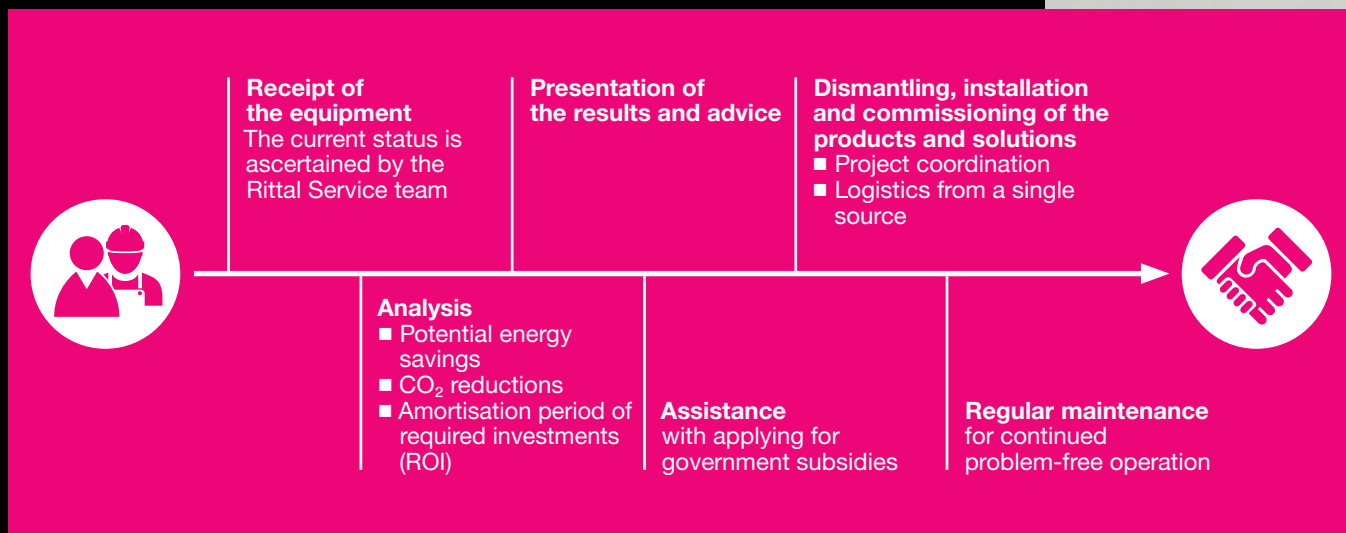

Note:

Please contact your local ASM or customer service team to discuss the scope and availability of this service in your region.

Rittal Manufacturer's Service – Service for industrial applications









Service agreements – Individual and combinable

Rittal service agreements allow you to tailor the scope of services to your specific requirements and combine various modules – with fixed, transparent terms and conditions.

The benefits for you:

- Maximum uptime
- Plannable costs
- Guaranteed response times
- Warranty extension
- Individual stocking of spares

		Scope of services included in standard agreement		Optional modules	
Maintenance 		1 x per year		2 x per year	
Availability 		Working days (Mon – Fri) 7 am – 5 pm	Working days (Mon – Fri) 24 hours	Every day of the week (Mon – Sun) 24 hours	
On-site service 		Next working day (Mon–Fri) 7 am–5 pm	Next week day (Mon – Sat) 7 am–5 pm	Within 8 hours	Within 4 hours
Warranty extension 		No contract commitment, separate agreement	Contract extension +12/+24/+36 months	Preventive replacement of worn parts +12/+24/+36 months	
Stocking of spare parts 		At Rittal	At Rittal and delivered within 24 hours	Individually agreed	
Inspection 		1 x per year	4 x per year	12 x per year	

Note:

Please contact your local ASM or customer service team to discuss the scope and availability of this service in your region.

Rittal Manufacturer's Service – Service agreements for industrial applications



Rittal Automation Systems – Professional service for your machines







No-one knows your machines better than the manufacturer.

Our Manufacturer's Service specialists safeguard the availability and performance of your machines. Regular maintenance of your machines ensures a long service life and a high degree of fail-safe operation.

With our service, you can benefit from consistently high quality and rely on your machines operating exactly as expected.

Service agreements – Individual and combinable

Rittal service agreements allow you to tailor the scope of services to your specific requirements and combine various modules – with fixed, transparent terms and conditions.

		Scope of services included in standard agreement	Optional modules
Maintenance 		1 x per year	2 x per year
Availability 		Working days (Mon – Fri) 7 am – 5 pm	Every day of the week (Mon – Sun) 24 hours
On-site service 		Within 72 hours, incl. reduced hourly rate	Within 48 hours, incl. reduced hourly rate
Warranty of the machine 		No warranty extension	+ 12 months
Individual stocking of spares 		On request	
DXF remote training 		One training session	
Software update 		As necessary (but excluding hardware/PC or operating system replacement)	

Note:

Please contact your local ASM or customer service team to discuss the scope and availability of this service in your region.

Rittal Manufacturer's Service – Service for machines



Maintenance and troubleshooting

Modern IT systems are the lifeblood of many companies. As data volumes grow ever larger and more complex, today it is more important than ever before to rely on a functioning digital infrastructure which is always available. Detailed expert knowledge, short response times and exceptional support quality are basic requirements for every Rittal service. Put your trust in our proven abilities.

IT Health Check

Exceptional performance and early risk detection by servicing your IT infrastructure.

The IT Health Check provides an insight into the maintenance status of your cooling systems and any leaks, as well as energy efficiency and sustainability, the capacity utilisation and scalability of your systems, any obsolescence risks, alarm chains, redundancy circuits, and compliance with statutory requirements, guidelines and standards.

As the outcome of the IT Health Check you will receive an assessment report containing individual optimisation and organisation options including identified cost drivers, potential savings and risk minimisation associated with the optional, predictive replacement of wearing parts.

The benefits for you:

- Individual optimisation and modernisation options
- A list of identified cost drivers and potential savings
- Risk management with predictive replacement of wearing parts

Note:

Please contact your local ASM or customer service team to discuss the scope and availability of this service in your region.



Rittal Manufacturer's Service – Service for IT infrastructure











Service agreements – Individual and combinable

Rittal service agreements allow you to tailor the scope of services to your specific requirements and combine various modules – with fixed, transparent terms and conditions.

The benefits for you:

- Maximum uptime
- Plannable costs
- Guaranteed response times
- Individual stocking of spares
- Warranty extension

		Scope of services included in standard agreement		Optional modules	
Maintenance 		1 x per year		2 x per year	
Availability 		Working days (Mon – Fri) 7 am – 5 pm	Working days (Mon – Fri) 24 hours	Every day of the week (Mon – Sun) 24 hours	
On-site service 		Next working day (Mon–Fri) 7 am – 5 pm	Next week day (Mon–Sat) 7 am–5 pm	Within 8 hours	Within 4 hours
Warranty extension 		+12/+24/+36 months, includes defined spare parts and repairs		+12/+24/+36 months, includes defined spare parts, repairs and predictive replacement of wearing parts	
Stocking of spare parts 		At Rittal	At Rittal and delivered within 24 hours	Individually agreed	
Inspection 		1 x per year	4 x per year	12 x per year	
Leakage test 		1 x per year from 5 t CO ₂ equivalent	2 x per year from 50 t CO ₂ equivalent	4 x per year from 500 t CO ₂ equivalent	
Replacement of wearing parts 		By operating hours			

Note:

Please contact your local ASM or customer service team to discuss the scope and availability of this service in your region.

Rittal Manufacturer's Service – Service agreements for IT infrastructure

Rittal Service International
 Hotline: +49 02772 308-1889
 E-Mail: service@rittal.de

Ihre Vertragsnummer: _____

Letzte Wartung: _____

Prüfung
 Wartung
 Bitte Plakette aufbringen

Geprüfte Klimatisierung

SCHLITZBAU STROMKABELUNG KABELKANNEN

FRIEDHELM LOH GROUP



RITTAL GmbH & Co. KG
 Address: Sülzböschung
 D-35576 Herborn

China: service@rittal.cn +86 800 820 0998
North America: service@rittal.us +1 800 477 4000 opt. 3

Europe: service@rittal.de +49 2772 308 1889
South America: service@rittal.com.br +55 11 36 22 23 77

India: service@rittal.in +91 80 22 890 783

Japan: service@rittal.jp +81 3 56 22 23 77

Other countries: service@rittal.com

Technical specifications:
 Rittal KVM 1.8-94
 48 / 38 mm
 48 kg
 2018
 CE

Smart Service

Increased machine availability and optimised service processes for Rittal components in the Blue e+ generation.

Rittal Smart Service visualises the operational performance of Blue e+ cooling units and transfers data in real time for prompt identification of maintenance requirements and critical errors. The automated processing of device data allows fast, efficient troubleshooting.

In the event of a malfunction, you receive situation-specific recommendations and can generate energy efficiency reports via the Rittal Smart Service portal.

Benefit from a combination of event-related recommendations and manufacturer expertise, remote diagnosis and advice from Rittal service experts as the basis for your predictive maintenance.

The advantages to you:

- Asset management and control of maintenance measures
- Visualisation of device data via Web portal including monitoring (condition monitoring)
- Access to operating and temperature characteristics
- Energy efficiency reports and efficiency analyses
- Situational recommendations based on manufacturer expertise

How you benefit:

- Enhanced machine availability
- Increased service efficiency and lower servicing costs, thanks to requirement-driven maintenance
- Fast problem analysis and troubleshooting with remote diagnosis

Note:

Please contact your local ASM or customer service team to discuss the scope and availability of this service in your region.



Blue e+ generation

Smart Service – Predictive and efficient



Smart Service Cloud

- Unidirectional, encrypted data transmission
- Certified Cloud in Germany

Data analyses

Based on manufacturer expertise

- Development of intelligent algorithms
- The basis for preventive maintenance

Smart Service Portal

- Overview of networked devices (asset management)
- Access to operating data
- The latest messages and recommended actions
- Energy consumption

Monitoring by Rittal service experts

- Continuous monitoring of device statuses in real time
- Remote diagnosis with manufacturer know-how
- Situational advice on optimum measures

Service engineers

- Respond on demand
- Ensure fast, efficient on-site troubleshooting

Automated handling

- Identification of the correct spare part
- Initiation of service measures

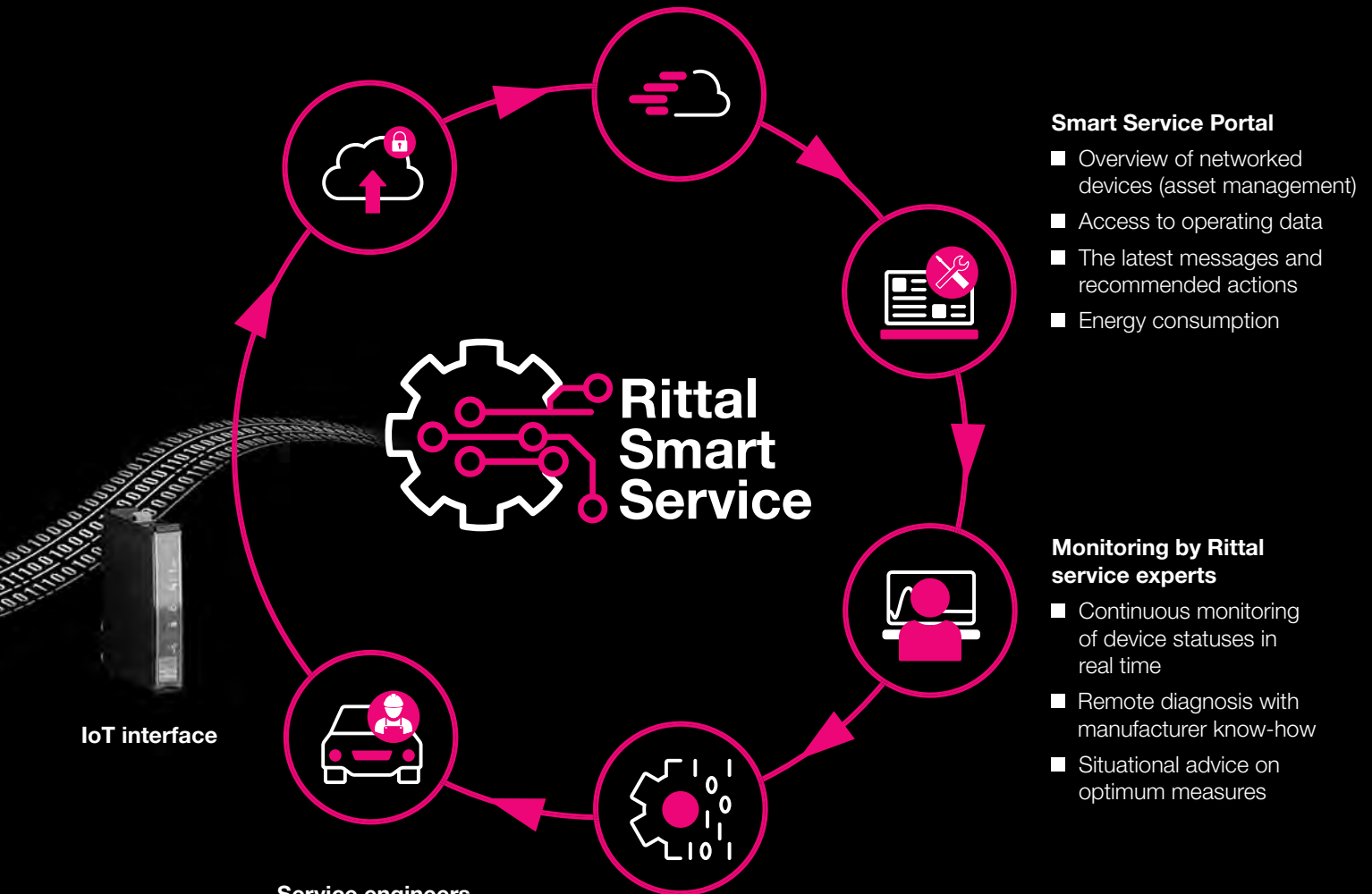

IoT interface

**Rittal
Smart
Service**

Smart Service – Bespoke and demand-driven

You can opt into our Smart Service at any time and flexibly adapt it to suit your requirements. In this way, we tailor the appropriate service level and range of services to each individual customer.

Rittal Smart Service offers various different service levels, which build on one another to become ever more comprehensive.

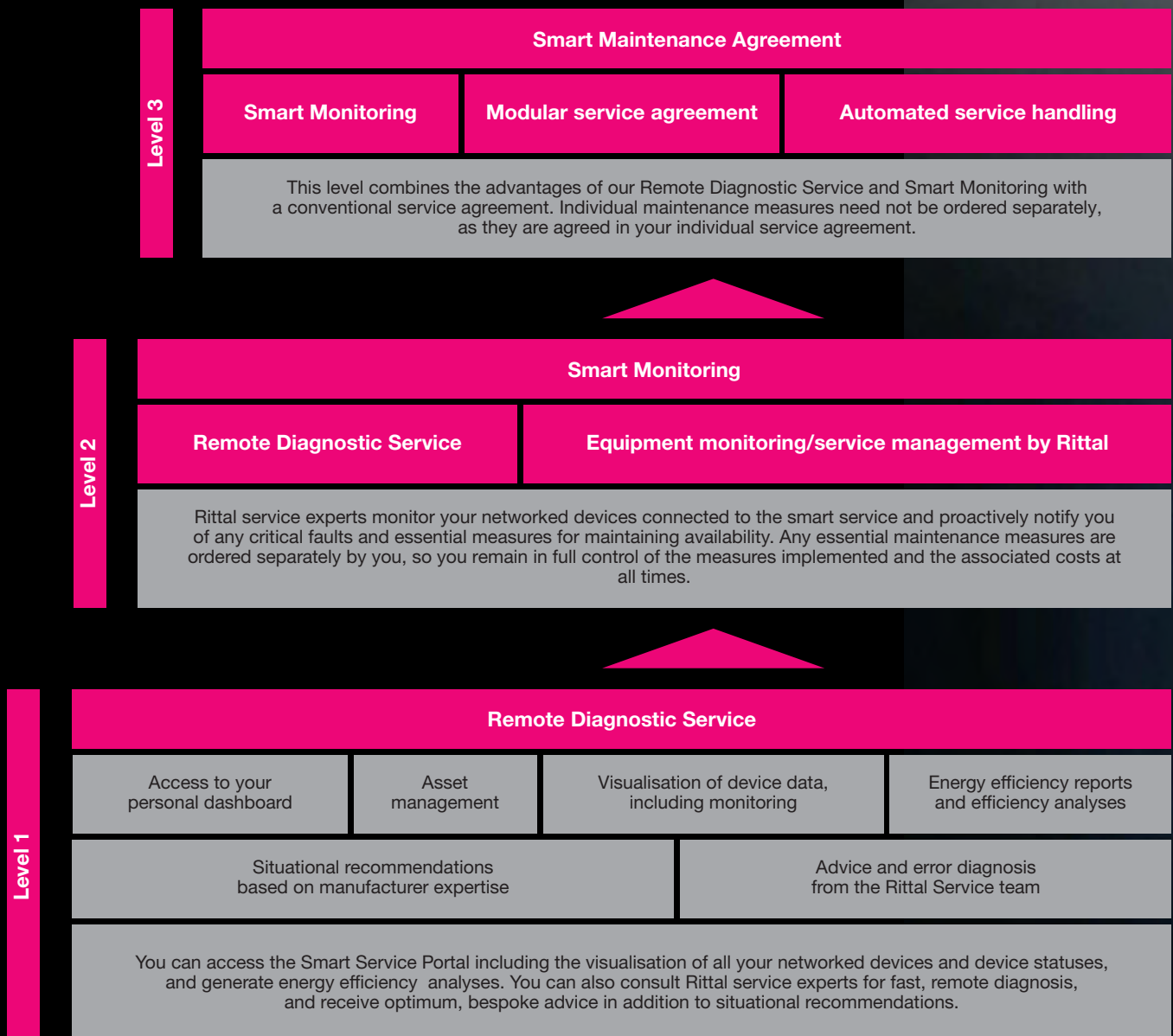

Note:

Please contact your local ASM or customer service team to discuss the scope and availability of this service in your region.



Rittal Service

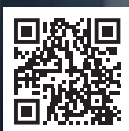

Please contact us with any questions you may have relating to our service portfolio; we will be happy to issue quotes and provide practical assistance.

www.rittal.com/service-worldwide

Quality management is a must. Quality philosophy is an attitude.

“Rittal – The System.” stands for consistent quality management and on-going refinements to products, services and internal processes.

Rittal quality management ensures that regulations and standards are observed, and individual customer requirements are met. In addition to this, we also define our exacting product quality demands in supplementary Rittal standards. The consistent Rittal quality philosophy guarantees perpetually high standards and ensures the global usability of all products with countless international approvals and licences.

Alongside product quality, we also focus on process and service quality.

All internal processes are continuously refined by quality control groups, and reviewed during in-house audits. Each year, our improvements and high standards are verified by countless successful external system and customer audits.



Rittal offers support from day one

- Project planning of technical specifications
- Prototype assembly, testing and simulations
- Manufacturing and assembly
- Warehousing service and on-time delivery
- Your own personal point of contact throughout the entire project

Accredited Rittal test laboratory

- Simulation of climatic conditions
- Dynamic and static load tests
- 3D measurement
- Testing of IP/IK protection categories and NEMA type ratings
- Corrosion testing
- Electrical safety and function tests
- Software tests
- Performance testing of chillers, cooling units and heat exchangers
- Material testing



Quality management



Project handling with Rittal and Eplan tools

Software and services spanning the entire value chain

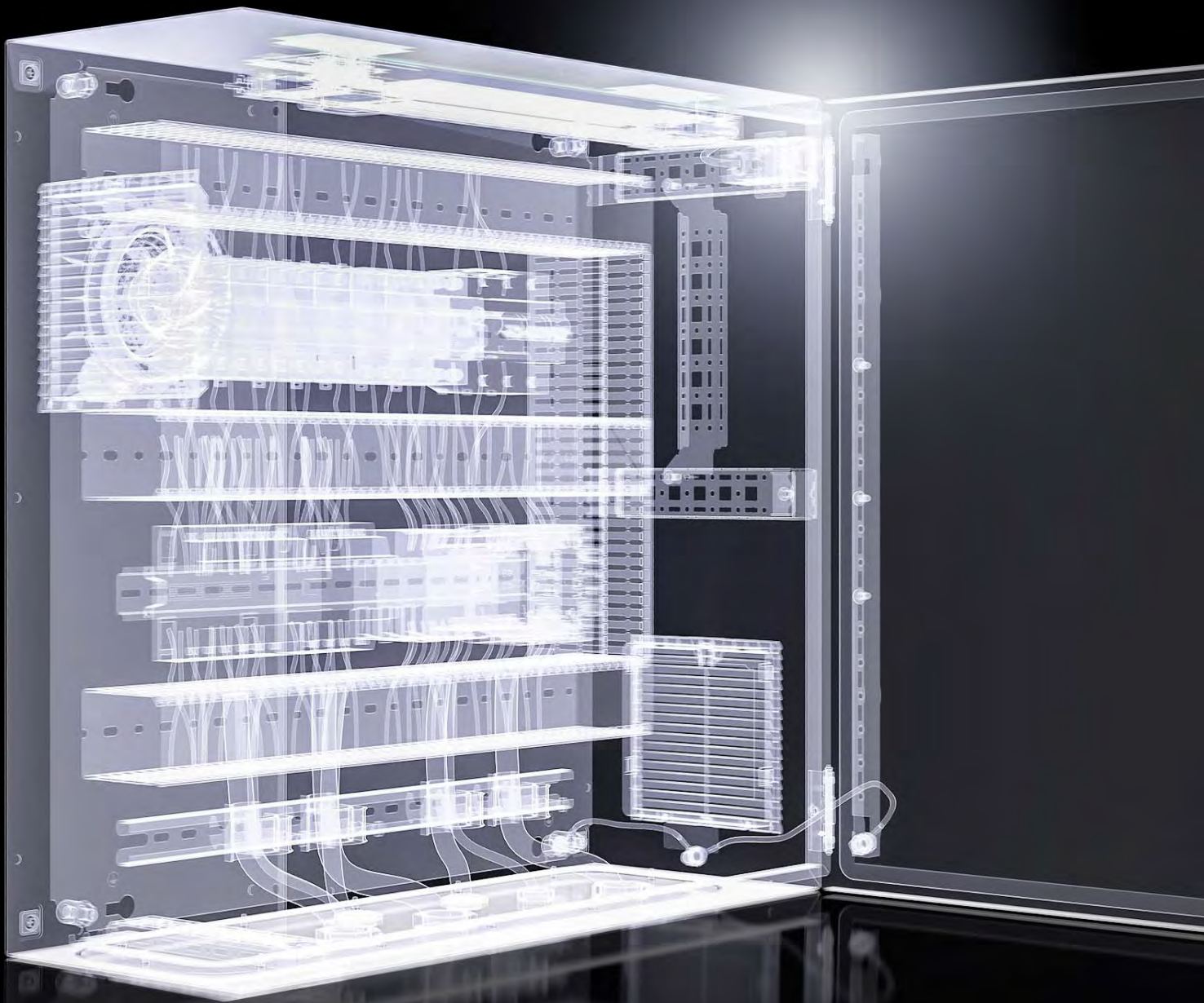

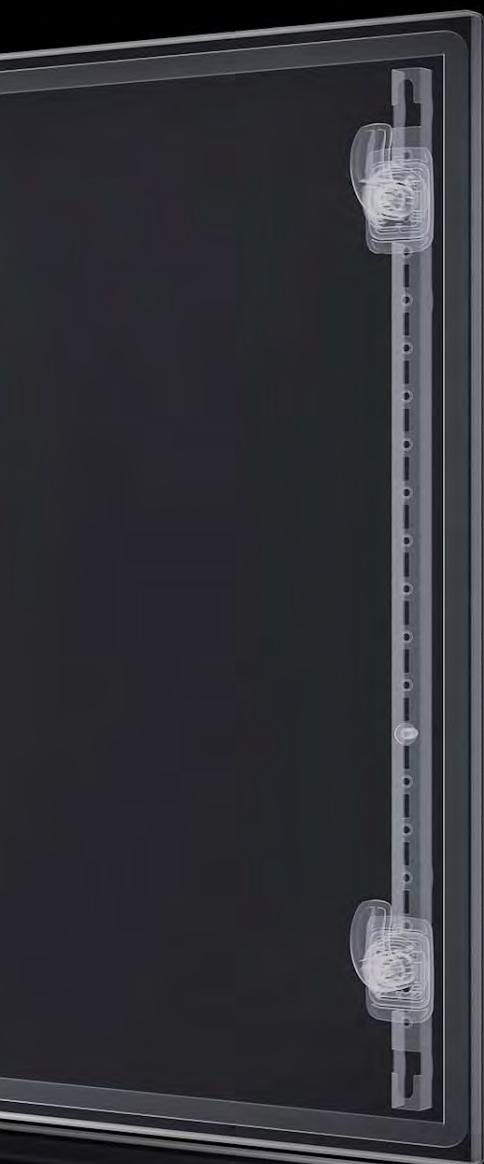

Boost your efficiency everywhere – with individual software and service modules from Rittal and Eplan

From small businesses and medium-sized companies to fully automated large-volume producers, our comprehensive portfolio provides every rack and controlgear manufacturer with a suitable selection of software and service modules tailored precisely to their individual production process. Optimum compatibility between all tools, even those that are not currently required or used, ensures maximum continuity and efficiency in both manual, semi-automated and fully automated production.

The benefits for you:

- Efficient software tools
- Plausibility-checked product and accessory configurations
- Plan cut-outs and drilled holes
- Generate tested manufacturing documents for the configured racks
- Transfer data into Eplan tools
- Enquire about configured products or order directly online
- Transfer data into Rittal machining centres
- Service modules tailored to individual requirements



Sourcing

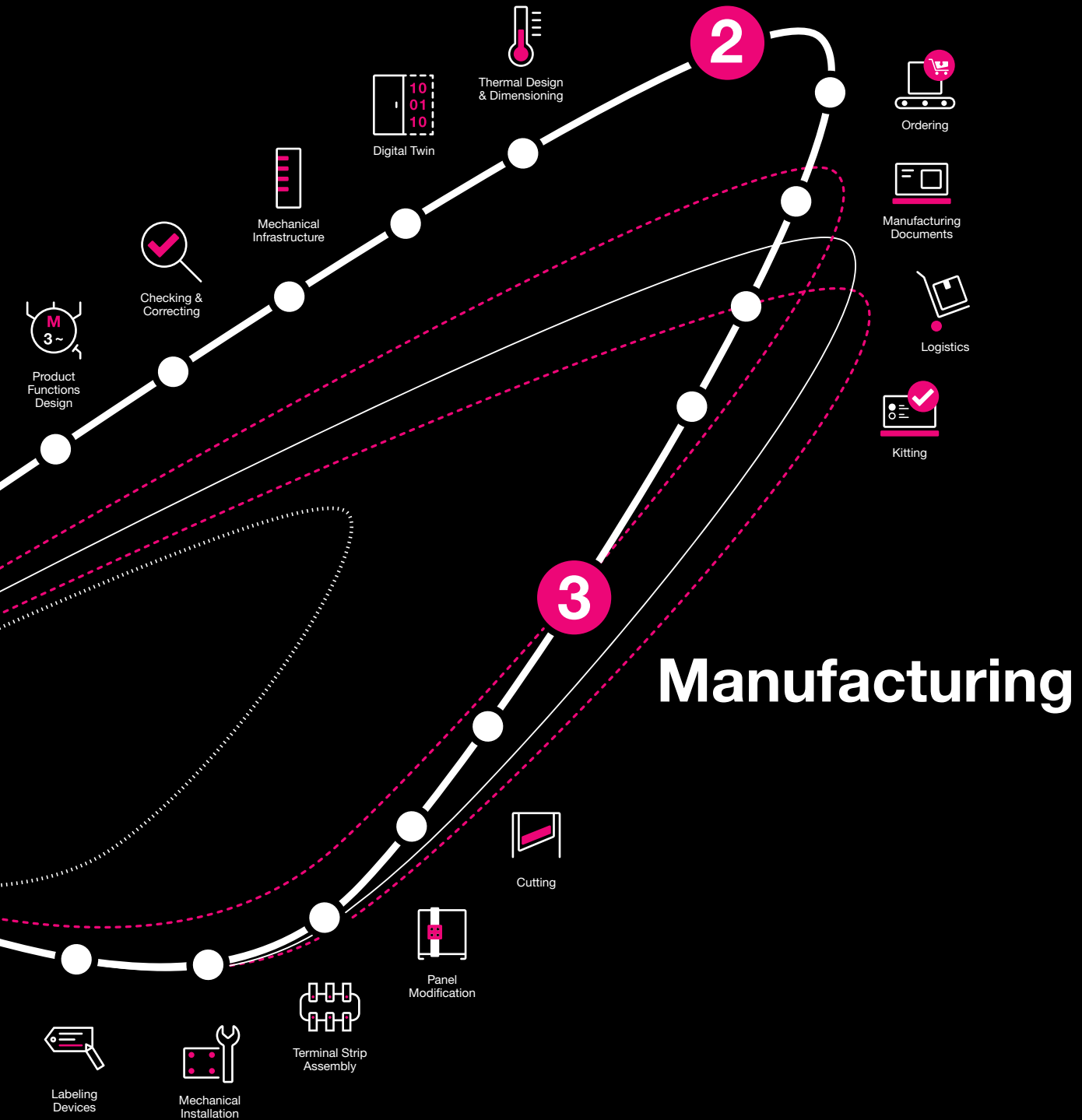

Manufacturing

Software and tools for industry

Enclosure

Rittal Configuration System

Select, plan and order plausibility-checked enclosures and components easily.

See page 272

Command panel configurators for aluminium command panels

The online configurators for Comfort Panel and Optipanel help you to configure individual, perfectly coordinated panel solutions.

See page 273

Support arm configurator for CP 40/60/120/180, support section, height-adjustable

Plausibility-checked planning of support arm systems.

See page 273

Online conversion assistant for small enclosures KX and compact enclosures AX

Convert quickly and easily with the parts list converter.

See page 274

Power Distribution

VX25 Power Engineering

The Web-based tool guides users quickly and efficiently through the entire switchgear planning process in simple, logical steps.

See page 446

Climate Control

Chiller configurator

The chiller configurator is a cost-effective way of selecting your required machine and process cooling.

See page 558

Therm software

Clever climate control planning

Therm takes care of the time-consuming calculation of your climate control requirements and proposes a suitable selection of products.

See page 558

RiDiag

RiDiag is a software package for the diagnosis and analysis of cooling units and chillers to ensure proper operation and to simplify maintenance and the diagnosis of system messages.

See page 559

Blue e+ app

The Blue e+ app supports the contactless exchange of information as well as rapid on-site analysis via the NFC interface.

See page 559

Rittal Automation Systems

Take value creation to the next level by working more efficiently with the latest tools and new automation solutions.

See page 560

General

CAD data

Greater efficiency in plant design

2D and 3D CAD data for all Rittal components in more than 70 different formats, for use in all standard commercially available CAD systems. Fast online access to original files in all common CAD formats.

See page 274

Product scan app

All product information in a single scan

Fast access to all relevant product information by scanning the QR code on the product.

See page 274

Eplan

Engineering solutions from Eplan help companies to optimise their controlgear and switchgear manufacturing processes. At its heart is the digital twin, which uses seamless data to link all value creation processes together.

See page 14

Further configurators may be found on the Internet at www.rittal.com/configurators



Software and tools for IT infrastructure

Racks and enclosures

Rittal Configuration System

Easily select plausibility-checked enclosures and components, plan machining and place your order.
See page 272

IT infrastructure selector

The selector supports partners, system integrators, system engineers and end clients in selecting the right IT products for their specific application.
See page 874

RiMatrix S Selector

Your standardised data centre selector for SMEs, branch concepts and flexible cloud applications. Your solution is configured on the basis of standardised data centre modules.
See page 874

Micro Data Center configurator

Configuration of your security safe, including a range of configuration components.
See page 874

IT power

PDU configurator

The PDU configurator helps you to configure and equip customised PDUs. The PDU portfolio allows you to generate the optimum product for your application.
See page 875

IT cooling

IT cooling calculator

Easily select water-based Liquid Cooling Packages (LCP) for rack and suite cooling for your IT infrastructure.
See page 875

Blue e+ app

The Blue e+ app supports the contactless exchange of information as well as rapid on-site analysis via the NFC interface.
See page 559

General

CAD data

Greater efficiency in plant design
2D and 3D CAD data for all Rittal components in more than 70 different formats, for use in all standard commercially available CAD systems. Fast online access to original files in all common CAD formats.
See page 274

Product scan app

All product information in a single scan
Fast access to all relevant product information by scanning the QR code on the product.
See page 274

DCIM – Data Centre Infrastructure Management

RiZone provides perfect support for your IT infrastructure components. Customer-centric and cost-efficient
See page 828



List of model numbers

1003.000 to 2360.000

Model No.		Page	Model No.		Page	Model No.		Page	Model No.		Page
1003.000	AX	237	1320.600	HD	221	1551.000	KX	65	1934.200	EL	1092
1005.000	AX	237	1338.000	AX	86	1552.000	KX	65	1935.200	EL	1092
1006.000	AX	238	1339.000	AX	87	1553.000	KX	66	1936.200	EL	1092
1007.000	AX	239	1350.000	AX	87	1554.000	KX	66	1937.200	EL	1092
1008.000	AX	238	1360.000	AX	88	1555.000	KX	66	1939.200	EL	1092
1009.000	AX	239	1376.000	AX	88	1556.000	KX	66	1950.000	EL	1092
1010.000	AX	239	1380.000	AX	86	1557.000	KX	66	1962.200	SR	1078
1011.000	AX	238	1432.000	AX	94	1560.000	KX	230	1963.200	SR	1078
1012.000	AX	239	1434.000	AX	94	1560.800	KX	970	1980.200	SR	1078
1013.000	AX	239	1444.000	AX	94	1561.000	KX	230	2034.010	AX	1076
1014.000	AX	240	1446.000	AX	94	1561.800	KX	970	2090.000	DK	1097
1015.000	AX	238	1448.000	AX	95	1562.000	KX	230	2092.200	EL	1098
1016.000	AX	240	1449.000	AX	95	1562.800	KX	970	2092.500	EL	1098
1017.000	AX	240	1453.000	AX	94	1563.000	KX	231	2094.200	EL	1098
1018.000	AX	240	1454.000	AX	95	1563.800	KX	970	2094.400	DK	1098
1019.000	AX	240	1466.000	AX	94	1564.000	KX	230	2094.500	EL	1098
1031.000	AX	86	1467.000	AX	95	1564.800	KX	970	2203.400	IN	1061
1033.000	AX	85	1468.000	AX	94	1565.000	KX	230	2231.000	EL	1094
1034.000	AX	85	1469.000	AX	95	1565.800	KX	970	2232.000	EL	1094
1037.000	AX	86	1479.000	AX	95	1566.000	KX	231	2233.000	EL	1094
1038.000	AX	86	1480.000	AX	94	1566.800	KX	970	2243.605	EL	717
1039.000	AX	87	1485.100	AX	96	1567.000	KX	231	2246.605	EL	717
1045.000	AX	86	1485.200	AX	97	1567.800	KX	970	2249.605	EL	717
1050.000	AX	87	1485.300	AX	97, 261	1568.000	KX	231	2252.605	EL	718
1054.000	AX	88	1485.400	AX	97, 261	1568.800	KX	970	2253.605	EL	717
1055.000	AX	90	1485.500	KE	97, 261	1569.000	KX	231	2255.605	EL	718
1057.000	AX	87	1485.600	AX	96, 941	1569.800	KX	970	2256.605	EL	717
1058.000	AX	88	1500.000	KX	57	1570.800	KX	970	2259.605	EL	717
1059.000	AX	88	1501.000	KX	57	1570.810	KX	970	2261.605	EL	718
1060.000	AX	87	1502.000	KX	57	1571.800	KX	970	2262.605	EL	718
1073.000	AX	89	1503.000	KX	57	1572.800	KX	970	2265.605	EL	718
1076.000	AX	88	1504.000	KX	57	1573.800	KX	970	2271.605	EL	718
1077.000	AX	89	1505.000	KX	57	1574.000	KX	67	2304.010	HD	224
1090.000	AX	89	1506.000	KX	58	1574.800	KX	970	2304.100	SZ	943
1091.000	AX	89	1507.000	KX	57	1575.000	KX	67	2307.000	SZ	941
1100.000	AX	90	1508.000	KX	57	1575.800	KX	970	2308.000	SZ	945
1110.000	AX	91	1509.000	KX	58	1576.000	KX	67	2309.000	SZ	997
1114.000	AX	91	1510.000	KX	58	1576.800	KX	970	2309.100	KX	998
1115.000	AX	91	1511.000	KX	57	1577.000	KX	67	2309.110	SZ	943
1116.000	AX	91	1512.000	KX	58	1578.000	KX	67	2311.076	AX	953
1130.000	AX	91	1513.000	KX	58	1579.000	KX	67	2311.100	AX	953
1180.000	AX	90	1514.000	KX	56	1581.200	SZ	1054	2311.120	AX	953
1181.000	AX	90	1515.000	KX	56	1583.000	KX	234	2311.225	SZ	953
1199.100	SZ	916	1516.000	KX	56	1584.000	KX	233	2311.250	SZ	953
1213.000	AX	91	1517.000	KX	56	1585.000	KX	234	2313.150	SZ	997
1214.000	AX	91	1518.000	KX	56	1586.000	KX	234	2313.750	SZ	997
1260.000	AX	89	1527.000	KX	58	1587.000	KX	233	2314.000	SZ	997
1261.000	AX	89	1528.000	KX	56	1588.000	KX	233	2315.000	SZ	997
1280.000	AX	90	1529.000	KX	57	1589.000	KX	57	2316.000	SZ	997
1281.000	AX	90	1530.000	KX	59	1590.010	KX	965	2317.000	SZ	997
1301.000	KX	233	1531.000	KX	59	1592.200	KX	951	2318.000	SZ	997
1302.000	AX	238	1532.000	KX	59	1592.210	KX	951	2319.000	SZ	997
1302.600	HD	221	1533.000	KX	59	1594.010	KX	965	2334.000	SZ	1033
1303.000	AX	238	1535.000	KX	59	1610.000	KX	70	2335.000	SZ	1033
1304.000	AX	239	1536.000	KX	59	1611.000	KX	70	2343.000	SZ	1033
1305.000	AX	240	1537.000	KX	60	1612.000	KX	70	2350.000	SZ	1059
1306.600	HD	221	1538.000	KX	60	1613.000	KX	70	2351.000	SZ	1059
1307.600	HD	221	1539.000	KX	59	1670.600	HD	220	2352.000	SZ	1059
1308.600	HD	221	1540.000	KX	60	1671.600	HD	220	2353.000	SZ	1059
1310.600	HD	221	1541.000	KX	60	1672.600	HD	220	2354.000	SZ	1059
1314.600	HD	221	1545.000	KX	65	1674.600	HD	220	2355.000	SZ	1059
1315.600	HD	221	1546.000	KX	65	1675.600	HD	220	2356.000	SZ	1059
1316.600	HD	221	1547.000	KX	65	1676.600	HD	220	2357.000	SZ	1059
1317.600	HD	221	1548.000	KX	66	1931.200	EL	1092	2358.000	SZ	1059
1318.600	HD	222	1549.000	KX	66	1932.200	EL	1092	2359.000	SZ	1059
1319.600	HD	222	1550.000	KX	66	1933.200	EL	1092	2360.000	SZ	1059

List of model numbers

2361.010 to 2527.000

Model No.		Page	Model No.		Page	Model No.		Page	Model No.		Page
2361.010	AX	958	2389.000	SZ	1104	2436.800	SZ	903	2500.210	SZ	1015
2362.010	AX	958	2393.210	AX	989	2438.735	SZ	903	2500.211	SZ	1015
2363.010	AX	958	2393.250	AX	989	2440.735	SZ	903	2500.212	SZ	1016
2364.000	SZ	1036	2393.300	AX	989	2440.905	SZ	903	2500.213	SZ	1016
2365.000	SZ	1002	2393.350	AX	989	2446.000	SZ	954	2500.214	SZ	1016
2366.000	SZ	1002	2393.400	AX	989	2449.010	AX	951	2500.220	SZ	1016
2367.040	SZ	1030	2400.000	SZ	1046	2459.000	SZ	900	2500.300	SZ	1014
2367.060	SZ	1030	2400.300	SZ	1047	2459.500	SZ	900	2500.310	SZ	1014
2367.080	SZ	1030	2400.500	SZ	1047	2460.000	SZ	941	2500.311	SZ	1014
2367.120	SZ	1030	2401.000	SZ	908	2460.650	SZ	941	2500.312	SZ	1014
2367.160	SZ	1030	2402.000	SZ	908	2461.000	SZ	941	2500.313	SZ	1014
2367.200	SZ	1030	2410.001	HD	1057	2462.000	SZ	941	2500.314	SZ	1015
2368.001	SG	1123	2410.011	HD	1057	2463.000	SZ	941	2500.320	SZ	1015
2368.002	SG	1123	2410.021	HD	1057	2464.000	SZ	941	2500.400	SZ	1023
2370.151	SG	1124	2410.031	HD	1057	2465.000	SZ	941	2500.410	SZ	1023
2370.161	SG	1124	2410.111	HD	1057	2466.000	SZ	941	2500.420	SZ	1023
2370.171	SG	1124	2410.121	HD	1057	2467.000	SZ	942	2500.430	SZ	1023
2370.501	SG	1124	2410.131	HD	1057	2468.000	SZ	942	2500.435	SZ	1023
2370.511	SG	1124	2410.290	HD	1057	2469.000	SZ	942	2500.440	SZ	1023
2370.521	SG	1124	2411.601	SZ	1056	2472.010	AX	958	2500.450	SZ	1023
2370.531	SG	1124	2411.611	SZ	1056	2473.010	AX	958	2500.460	SZ	1024
2370.541	SG	1124	2411.621	SZ	1056	2474.010	AX	958	2500.470	SZ	1024
2370.551	SG	1124	2411.631	SZ	1056	2475.010	AX	958	2500.490	SZ	1024
2370.571	SG	1124	2411.641	SZ	1056	2476.010	AX	958	2500.500	SZ	1023
2371.001	SG	1124	2411.651	SZ	1056	2476.100	SZ	944	2500.520	SZ	1023
2371.021	SG	1124	2411.661	SZ	1056	2477.000	SZ	908	2500.530	SZ	1023
2372.001	SG	1124	2411.671	SZ	1056	2478.000	SZ	908	2500.550	SZ	1023
2372.011	SG	1124	2411.801	SZ	1056	2479.000	SZ	908	2500.600	SZ	1023
2372.021	SG	1124	2411.811	SZ	1056	2480.000	SZ	908	2500.610	SZ	1023
2372.031	SG	1124	2411.821	SZ	1056	2481.000	SZ	908	2500.620	SZ	1023
2372.041	SG	1124	2411.831	SZ	1056	2482.210	SZ	1117	2500.630	SZ	1023
2372.101	SG	1122	2411.841	SZ	1056	2482.220	SZ	1117	2500.640	SZ	1023
2372.102	SG	1122	2411.851	SZ	1056	2482.230	SZ	1117	2500.650	SZ	1023
2373.000	SZ	1004	2411.861	SZ	1056	2482.300	SZ	1118	2500.660	SZ	1024
2374.000	SG	1126	2411.871	SZ	1056	2482.310	SZ	1118	2500.670	SZ	1024
2374.010	SG	1126	2412.210	SZ	1033	2482.320	SZ	1118	2500.680	SZ	1023
2374.020	SG	1126	2412.216	SZ	1033	2482.330	SZ	1118	2500.710	SZ	1022
2374.030	SG	1126	2412.225	SZ	1033	2482.400	SZ	1118	2500.711	SZ	1022
2374.040	SG	1125	2412.310	SZ	1033	2482.410	SZ	1118	2500.712	SZ	1022
2374.050	SG	1126	2412.316	SZ	1033	2482.500	SZ	1118	2500.713	SZ	1022
2374.080	SG	1125	2412.325	SZ	1033	2482.510	SZ	1118	2500.714	SZ	1022
2374.150	SG	1127	2413.375	PS	1030	2482.540	SZ	1118	2500.715	SZ	1022
2375.030	SG	1125	2413.550	PS	1030	2482.550	SZ	1118	2503.020	AX	966
2376.001	SG	1127	2414.000	SM	1030	2482.560	SZ	1118	2504.000	SZ	1004
2376.011	SG	1127	2414.500	SM	1030	2482.570	SZ	1118	2504.500	SZ	1004
2376.021	SG	1127	2415.000	SZ	1030	2482.590	SZ	1118	2504.800	SZ	1004
2376.031	SG	1127	2415.100	SM	957	2482.600	SZ	1117	2505.510	SZ	967
2379.600	SZ	1111	2415.500	SM	981	2482.700	SZ	1117	2506.120	SZ	1042
2379.800	SZ	1111	2416.000	SZ	944	2482.710	SZ	1117	2508.020	AX	966
2379.900	SZ	1112	2418.000	SZ	944	2482.720	SZ	1117	2509.010	AX	964
2381.000	SM	1115	2419.000	SZ	944	2482.730	SZ	1117	2510.000	SZ	955
2382.000	SM	1116	2422.000	SZ	964	2483.000	SZ	941	2512.000	SZ	955
2383.020	SM	1116	2423.000	SZ	964	2485.000	SZ	942	2513.000	SZ	955
2383.030	SM	1110	2424.100	SZ	959	2485.100	SZ	942	2514.000	SZ	955
2384.010	SM	235	2425.100	SZ	959	2486.400	SZ	1004	2515.000	SZ	955
2384.020	SM	235	2426.100	SZ	959	2486.600	SZ	1004	2515.200	AX	954
2384.030	SM	235	2426.500	SZ	959	2487.000	SZ	1004	2515.300	AX	954
2384.040	SM	235	2427.100	SZ	959	2488.000	SZ	1004	2515.400	AX	954
2388.050	SZ	1029	2433.000	SZ	261	2489.000	SZ	1004	2519.010	SZ	956
2388.100	SZ	1029	2433.010	AX	967	2489.500	SZ	1004	2519.200	CM	956
2388.125	SZ	1029	2433.510	AX	967	2493.500	SZ	944	2521.000	SZ	945
2388.150	SZ	1029	2435.100	AX	939	2500.100	SZ	1017	2522.000	SZ	941
2388.200	SZ	1029	2435.200	AX	939	2500.104	SZ	1017	2523.000	SZ	941
2388.280	SZ	1029	2435.300	AX	939	2500.110	SZ	1017	2525.000	SZ	943
2388.650	SZ	1029	2435.400	AX	939	2500.114	SZ	1017	2526.000	SZ	941
2388.850	SZ	1029	2436.735	SZ	903	2500.200	SZ	1015	2527.000	SZ	941

List of model numbers

2528.000 to 3185.030

Model No.		Page	Model No.		Page	Model No.		Page	Model No.		Page
2528.000	SZ	941	2580.007	AX	1051	2742.010	AX	931	3083.000	SV	389
2531.000	SZ	945	2580.008	AX	1051	2743.010	AX	931	3085.000	SV	343
2532.000	SZ	945	2580.009	AX	1051	2744.010	AX	931	3086.000	SV	350
2533.000	SZ	942	2580.010	AX	1051	2745.010	AX	931	3087.000	SV	350
2535.000	SZ	943	2580.011	AX	1051	2746.010	AX	931	3088.000	SV	350
2536.000	SZ	943	2580.012	AX	1051	2749.100	AX	932	3090.000	SV	350
2537.100	AX	940	2580.013	AX	1051	2760.010	AX	930	3091.000	SV	350
2537.300	AX	940	2580.014	AX	1051	2761.010	AX	930	3092.000	SV	343
2541.235	SK	539	2580.100	AX	1051	2762.010	AX	930	3093.010	SV	356
2542.235	SK	539	2580.115	AX	1051	2763.010	AX	930	3093.020	SV	356
2543.235	SK	539	2580.116	AX	1051	2780.000	FT	930	3105.310	SK	530
2545.000	SZ	945	2580.117	AX	1051	2781.000	FT	930	3105.320	SK	530
2546.000	SZ	945	2580.118	AX	1051	2782.000	FT	930	3105.330	SK	530
2547.000	SZ	945	2580.119	AX	1051	2784.000	FT	930	3105.340	SK	530
2548.000	SZ	945	2580.120	AX	1051	2785.000	FT	930	3105.350	SK	530
2549.000	SZ	945	2580.121	AX	1051	2786.000	FT	930	3105.360	SK	530
2549.500	SZ	945	2580.122	AX	1051	2787.000	FT	930	3105.370	SK	530
2549.510	HD	224	2580.123	AX	1051	2788.000	FT	930	3105.380	SK	531
2549.600	HD	224	2580.124	AX	1051	2789.000	FT	930	3105.390	SK	531
2559.000	SZ	1033	2580.125	AX	1051	2793.560	FT	931	3105.400	SK	531
2561.200	AX	1050	2582.100	AX	1051	2796.000	FT	930	3105.410	SK	531
2561.300	AX	1052	2582.200	AX	1051	2807.200	PS	890	3105.420	SK	531
2562.200	AX	1050	2582.400	AX	1051	2817.000	SO	885	3105.430	SK	531
2562.300	AX	1052	2582.600	AX	1051	2819.000	SZ	891	3108.024	SK	539
2563.200	AX	1050	2583.010	SZ	967	2819.200	SZ	891	3108.100	SK	539
2563.300	AX	1052	2583.080	AX	1048	2820.061	AX	888	3108.115	SK	539
2564.000	SZ	1033	2583.100	AX	1048	2820.062	AX	888	3110.000	SK	547
2564.200	AX	1050	2583.120	AX	1051	2820.081	AX	888	3110.200	SK	548
2564.300	AX	1052	2584.100	AX	968	2820.082	AX	888	3114.200	SK	546
2565.000	SZ	1033	2589.000	SZ	1060	2820.101	AX	888	3118.000	SK	547
2565.050	SZ	1033	2590.000	SZ	1060	2820.102	AX	888	3120.200	SK	549
2565.100	SZ	1033	2591.000	SZ	1060	2820.121	AX	888	3124.100	SK	550
2565.110	SZ	1033	2592.000	SZ	1060	2820.122	AX	888	3124.300	SK	554
2565.120	SZ	1033	2593.000	SZ	1060	2820.310	AX	889	3124.310	SK	555
2565.200	AX	1050	2594.000	SZ	1060	2820.320	AX	889	3124.400	SK	549
2565.300	AX	1052	2595.000	SZ	1060	2820.410	AX	889	3126.100	SK	469
2565.400	AX	1054	2596.000	SZ	1060	2820.420	AX	889	3127.100	SK	469
2566.000	SZ	1033	2597.000	SZ	1061	2843.160	SZ	1030	3128.100	SK	469
2566.200	AX	1050	2683.600	TP	251	2843.200	SZ	1030	3129.100	SK	469
2566.300	AX	1052	2684.600	TP	251	2843.250	SZ	1030	3130.100	SK	469
2566.400	AX	1054	2685.600	TP	251	2843.320	SZ	1030	3138.000	SK	464
2567.000	SZ	1033	2686.600	TP	251	2843.400	SZ	1030	3139.100	SK	464
2567.200	AX	1050	2694.500	TP	162	2843.500	SZ	1030	3139.110	SK	464
2567.300	AX	1052	2695.500	TP	162	2843.630	SZ	1030	3140.100	SK	464
2567.400	AX	1054	2696.500	TP	163	2859.000	SO	893	3140.110	SK	464
2568.000	SZ	1033	2730.010	AX	930	2865.000	TP	890	3140.140	SK	464
2569.000	SZ	1033	2731.010	AX	930	2867.000	TP	890	3140.500	SK	465
2570.000	SZ	1033	2732.010	AX	930	2869.000	TP	890	3140.510	SK	465
2570.500	SZ	1034	2733.010	AX	930	2870.000	TP	890	3144.000	SK	468
2571.000	SZ	943	2735.250	FT	929	2899.200	SZ	1048	3159.100	SK	559
2571.100	AX	1053	2735.500	FT	929	2899.250	SZ	1048	3159.300	SK	559
2572.000	SZ	943	2735.510	FT	929	2899.320	SZ	1048	3164.230	SK	789
2572.100	AX	1053	2735.520	FT	929	2899.400	SZ	1048	3164.620	SK	789
2573.000	SZ	1045	2735.530	FT	929	3031.000	SV	341	3171.100	SK	535
2573.100	AX	1053	2735.540	FT	929	3032.000	SV	341	3171.105	SK	535
2574.100	AX	1053	2735.560	FT	929	3052.000	SV	388	3172.100	SK	535
2575.000	SZ	943	2735.570	FT	929	3055.000	SV	388	3172.105	SK	535
2575.100	AX	1053	2735.580	FT	929	3056.000	SV	388	3173.100	SK	535
2576.000	SZ	942	2735.590	FT	929	3057.000	SV	388	3173.105	SK	535
2576.100	AX	1053	2736.500	FT	929	3071.000	SV	358	3174.100	SK	535
2577.100	AX	1053	2736.510	FT	929	3073.000	SV	388	3176.000	SK	539
2580.000	AX	1051	2736.520	FT	929	3074.000	SV	388	3177.000	SK	533
2580.003	AX	1051	2736.530	FT	929	3075.000	SV	388	3181.100	SK	536
2580.004	AX	1051	2736.540	FT	929	3076.000	SV	388	3182.100	SK	536
2580.005	AX	1051	2740.010	AX	931	3079.000	SV	346	3183.100	SK	536
2580.006	AX	1051	2741.010	AX	931	3079.010	SV	346	3185.030	SK	505

List of model numbers

3185.330 to 3335.930

Model No.		Page	Model No.		Page	Model No.		Page	Model No.		Page
3185.330	SK	497	3239.080	SK	538	3286.610	SK	534	3311.163	SK	788
3185.530	SK	487	3239.100	SK	457	3286.700	SK	556	3311.170	SK	788
3185.730	SK	504	3239.110	SK	457	3286.780	SK	542	3311.180	SK	788
3185.830	SK	487	3239.124	SK	457	3286.800	SK	556	3311.190	SK	788
3186.630	SK	489	3239.200	SK	537	3286.840	SK	540	3311.200	SK	788
3186.930	SK	489	3239.500	SK	461	3286.850	SK	541	3311.210	SK	788
3187.630	SK	489	3239.600	SK	459	3286.860	SK	541	3311.270	SK	788
3187.930	SK	489	3240.020	SK	538	3286.870	SK	540	3311.280	SK	788
3188.640	SK	489	3240.060	SK	537	3286.880	SK	542	3311.360	SK	785
3188.940	SK	489	3240.066	SK	535	3286.900	SK	556	3311.363	SK	785
3189.640	SK	489	3240.080	SK	538	3286.970	SK	540	3311.370	SK	785
3189.940	SK	489	3240.100	SK	457	3286.980	SK	542	3311.380	SK	785
3201.050	SK	535	3240.110	SK	457	3286.990	SK	540	3311.490	SK	768
3201.200	SK	474	3240.124	SK	457	3301.320	SK	786	3311.491	SK	770
3201.300	SK	474	3240.200	SK	537	3301.370	SK	786	3311.492	SK	768
3201.800	SK	507	3240.500	SK	461	3301.380	SK	786	3311.493	SK	770
3201.810	SK	507	3240.600	SK	459	3301.390	SK	786	3311.495	SK	785
3201.820	SK	507	3241.100	SK	457	3301.391	SK	1095	3311.496	SK	785
3201.830	SK	507	3241.110	SK	457	3301.392	SK	1096	3312.012	SK	786
3201.840	SK	507	3241.124	SK	457	3301.500	SK	543	3312.081	SK	786
3201.850	SK	507	3241.500	SK	461	3301.505	SK	543	3312.800	SK	764
3201.960	SK	550	3241.600	SK	460	3301.600	SK	544	3312.805	SK	784
3201.970	SK	550	3243.020	SK	538	3301.606	SK	544	3312.806	SK	784
3201.990	SK	545	3243.060	SK	537	3301.608	SK	544	3312.807	SK	784
3209.100	SK	516	3243.066	SK	535	3301.610	SK	544	3312.810	SK	765
3209.500	SK	516	3243.080	SK	538	3301.612	SK	544	3312.815	SK	784
3209.504	SK	516	3243.100	SK	457	3301.930	SK	545	3312.816	SK	784
3210.100	SK	517	3243.110	SK	457	3301.940	SK	545	3312.820	IT	784
3210.500	SK	517	3243.200	SK	537	3301.950	SK	545	3313.016	SK	787
3210.504	SK	516	3243.500	SK	462	3301.955	SK	545	3313.130	SK	781
3210.540	SK	517	3243.600	SK	460	3301.960	SK	545	3313.230	SK	781
3212.024	SK	510	3244.100	SK	458	3301.965	SK	545	3313.250	SK	781
3212.230	SK	510	3244.110	SK	458	3302.100	SK	476	3313.260	SK	781
3213.310	SK	542	3244.140	SK	458	3302.110	SK	476	3313.290	SK	774
3213.320	SK	542	3244.500	SK	462	3302.200	SK	476	3313.390	SK	775
3214.100	SK	510	3244.600	SK	460	3302.300	SK	475	3313.410	SK	774
3214.700	SK	515	3245.080	SK	538	3302.310	SK	475	3313.420	SK	774
3215.100	SK	511	3245.500	SK	462	3303.500	SK	478	3313.430	SK	775
3215.700	SK	515	3245.510	SK	462	3303.504	SK	490	3313.440	SK	775
3216.480	SK	514	3245.600	SK	460	3303.508	SK	495	3313.450	SK	775
3235.440	SK	548	3248.000	SK	470	3303.510	SK	478	3313.460	SK	776
3235.450	SK	548	3273.500	SK	500	3303.514	SK	490	3313.470	SK	776
3236.124	SK	539	3284.210	SK	534	3303.518	SK	495	3313.480	SK	776
3237.020	SK	538	3285.700	SK	536	3303.600	SK	478	3313.530	SK	783
3237.060	SK	537	3285.800	SK	533	3304.500	SK	479	3313.540	SK	783
3237.066	SK	535	3285.810	SK	534	3304.504	SK	490	3313.550	SK	783
3237.080	SK	538	3285.900	SK	533	3304.508	SK	495	3313.560	SK	783
3237.100	SK	456	3285.910	SK	534	3304.510	SK	479	3313.570	SK	783
3237.110	SK	456	3285.920	SK	533	3304.540	SK	479	3318.610	SK	519
3237.124	SK	456	3285.930	SK	534	3304.544	SK	490	3319.610	SK	519
3237.200	SK	537	3285.940	SK	533	3304.548	SK	495	3320.200	SK	523
3237.600	SK	459	3286.110	SK	533	3304.600	SK	479	3321.700	SK	535
3238.020	SK	538	3286.120	SK	534	3304.640	SK	479	3321.705	SK	535
3238.055	SK	536	3286.300	SK	533	3305.500	SK	480	3322.700	SK	535
3238.060	SK	537	3286.310	SK	534	3305.504	SK	490	3322.705	SK	535
3238.066	SK	535	3286.400	SK	533	3305.510	SK	480	3328.500	SK	481
3238.080	SK	538	3286.410	SK	534	3305.540	SK	480	3328.540	SK	481
3238.100	SK	456	3286.500	SK	533	3305.544	SK	490	3328.544	SK	491
3238.110	SK	456	3286.510	SK	534	3305.548	SK	495	3329.500	SK	482
3238.124	SK	456	3286.520	SK	534	3307.700	SK	506	3329.540	SK	482
3238.200	SK	537	3286.530	SK	534	3307.740	SK	506	3329.544	SK	491
3238.500	SK	461	3286.540	SK	534	3310.700	SK	506	3329.548	SK	495
3238.600	SK	459	3286.550	SK	534	3310.740	SK	506	3334.300	SK	523
3239.020	SK	538	3286.560	SK	534	3305.510	SK	785	3334.400	SK	523
3239.060	SK	537	3286.570	SK	534	3311.040	SK	786	3335.920	SK	528
3239.066	SK	535	3286.600	SK	533	3311.161	SK	788	3335.930	SK	528

List of model numbers

3335.940 to 4051.536

Model No.		Page	Model No.		Page	Model No.		Page	Model No.		Page
3335.940	SK	528	3384.540	SK	500	3565.005	SV	346	4050.456	AS	636
3335.950	SK	529	3384.600	SK	500	3568.005	SV	346	4050.463	AS	637
3335.960	SK	529	3385.500	SK	500	3569.005	SV	346	4050.467	AS	637
3335.970	SK	529	3385.510	SK	500	3570.005	SV	346	4050.468	AS	637
3336.400	SK	526	3385.540	SK	500	3571.005	SV	346	4050.722	AS	590
3336.405	SK	526	3385.600	SK	500	3572.005	SV	346	4050.723	AS	590
3336.410	SK	526	3385.640	SK	500	3573.005	SV	346	4050.730	AS	581
3336.415	SK	526	3386.540	SK	501	3574.005	SV	346	4050.731	AS	581
3336.430	SK	527	3386.640	SK	501	3575.005	SV	346	4050.732	AS	581
3336.435	SK	527	3387.540	SK	501	3576.005	SV	346	4050.733	AS	582
3336.450	SK	527	3387.640	SK	501	3577.005	SV	346	4050.734	AS	582
3336.455	SK	527	3418.010	SV	323	3578.005	SV	346	4050.735	AS	582
3340.230	SK	466	3418.020	SV	356	3579.005	SV	346	4050.736	AS	582
3341.115	SK	466	3418.030	SV	356	3580.000	SV	342	4050.737	AS	582
3341.230	SK	466	3418.040	SV	323	3580.100	SV	342	4050.738	AS	582
3342.024	SK	466	3427.010	SV	323	3581.000	SV	342	4050.739	AS	582
3342.230	SK	466	3427.020	SV	356	3581.100	SV	342	4050.740	AS	582
3342.500	SK	466	3427.030	SV	356	3582.000	SV	342	4050.741	AS	582
3350.230	SK	467	3427.040	SV	323	3582.020	SV	342	4050.742	AS	581
3351.230	SK	467	3431.000	SV	325	3583.000	SV	342	4050.743	AS	581
3352.230	SK	467	3431.020	SV	326	3584.000	SV	342	4050.744	AS	581
3352.500	SK	467	3431.030	SV	326	3584.020	SV	342	4050.745	AS	582
3355.100	SK	557	3431.035	SV	326	3585.005	SV	342	4050.746	AS	578
3355.700	SK	557	3433.010	SV	323	3585.020	SV	342	4050.747	AS	578
3355.710	SK	556	3433.020	SV	356	3586.005	SV	342	4050.748	AS	579
3355.720	SK	543	3433.030	SV	356	3586.020	SV	342	4050.749	AS	579
3357.100	SK	557	3433.040	SV	323	3587.000	SV	342	4050.750	AS	580
3359.500	SK	499	3439.010	SV	305	3588.005	SV	342	4050.752	AS	581
3359.510	SK	499	3450.500	SV	349	3589.005	SV	342	4050.754	AS	581
3359.540	SK	499	3450.505	SV	349	3590.005	SV	342	4050.757	AS	581
3359.600	SK	499	3451.500	SV	349	3590.015	SV	342	4050.760	AS	581
3361.500	SK	478	3451.505	SV	349	3590.020	SV	342	4050.761	AS	581
3361.510	SK	478	3452.500	SV	349	3591.060	SV	1039	4050.764	AS	581
3361.540	SK	478	3453.500	SV	349	3592.010	SV	358	4050.766	AS	581
3361.600	SK	478	3454.500	SV	349	3659.180	TS	1090	4050.769	AS	581
3363.100	SK	510	3455.500	SV	349	3659.190	TS	1090	4050.770	AS	582
3363.500	SK	510	3455.505	SV	349	4000.065	HD	223	4050.773	AS	582
3364.100	SK	511	3456.500	SV	349	4000.100	HD	223	4050.774	AS	582
3364.500	SK	511	3456.505	SV	349	4000.240	HD	223	4050.779	AS	582
3364.504	SK	511	3457.500	SV	349	4000.250	HD	223	4050.782	AS	582
3366.500	SK	483	3458.500	SV	349	4050.000	AS	611	4050.783	AS	582
3366.540	SK	483	3459.500	SV	349	4050.005	AS	616	4050.785	AS	582
3373.100	SK	512	3460.500	SV	350	4050.130	AS	613	4051.100	AS	620
3373.140	SK	512	3504.000	SV	344	4050.140	AS	591	4051.101	AS	621
3373.500	SK	512	3505.000	SV	344	4050.150	AS	607	4051.102	AS	621
3374.100	SK	512	3509.000	SV	344	4050.200	AS	607	4051.103	AS	622
3374.140	SK	512	3514.000	SV	344	4050.210	AS	608	4051.104	AS	622
3374.500	SK	512	3515.000	SV	344	4050.211	AS	608	4051.105	AS	623
3374.504	SK	512	3516.000	SV	344	4050.212	AS	608	4051.106	AS	623
3374.540	SK	512	3524.000	SV	344	4050.213	AS	608	4051.107	AS	624
3375.100	SK	513	3525.000	SV	344	4050.214	AS	608	4051.108	AS	624
3375.500	SK	513	3525.010	SV	344	4050.216	AS	609	4051.109	AS	628
3375.504	SK	513	3526.000	SV	344	4050.217	AS	609	4051.110	AS	628
3375.540	SK	513	3527.000	SV	344	4050.218	AS	609	4051.111	AS	625
3377.000	SK	556	3528.000	SV	344	4050.219	AS	610	4051.112	AS	628
3378.300	SK	518	3528.010	SV	344	4050.220	AS	609	4051.113	AS	627
3378.380	SK	518	3529.000	SV	344	4050.221	AS	610	4051.114	AS	625
3382.500	SK	498	3548.000	SV	352	4050.222	AS	610	4051.115	AS	624
3382.510	SK	498	3550.000	SV	349	4050.300	AS	607	4051.116	AS	626
3382.600	SK	498	3554.000	SV	350	4050.435	AS	604	4051.117	AS	626
3383.500	SK	499	3555.000	SV	349	4050.436	AS	604	4051.118	AS	627
3383.510	SK	499	3559.000	SV	350	4050.437	AS	605	4051.119	AS	627
3383.540	SK	499	3560.000	SV	350	4050.451	AS	633	4051.120	AS	625
3383.600	SK	499	3561.000	SV	350	4050.452	AS	635	4051.121	AS	626
3384.500	SK	500	3562.000	SV	350	4050.454	AS	634	4051.525	AS	582
3384.510	SK	500	3563.000	SV	350	4050.455	AS	632	4051.536	AS	578

List of model numbers

4051.537 to 4127.010

Model No.		Page	Model No.		Page	Model No.		Page	Model No.		Page
4051.537	AS	579	4052.212	AS	567	4055.116	AS	599	4055.550	AS	596
4051.538	AS	579	4052.480	AS	570	4055.118	AS	599	4055.554	AS	596
4051.539	AS	580	4052.500	AS	591	4055.120	AS	599	4055.560	AS	596
4051.540	AS	578	4053.000	AS	565	4055.122	AS	599	4055.563	AS	596
4051.541	AS	578	4053.002	AS	571	4055.125	AS	599	4055.580	AS	597
4051.542	AS	579	4053.003	AS	571	4055.128	AS	599	4055.581	AS	597
4051.543	AS	579	4053.011	AS	571	4055.130	AS	599	4055.582	AS	598
4051.544	AS	578	4053.012	AS	571	4055.132	AS	599	4055.600	AS	602
4051.545	AS	579	4053.021	AS	571	4055.134	AS	599	4055.601	AS	602
4051.546	AS	579	4053.022	AS	571	4055.137	AS	599	4055.602	AS	602
4051.547	AS	580	4053.031	AS	571	4055.140	AS	599	4055.603	AS	602
4051.548	AS	578	4053.032	AS	571	4055.143	AS	599	4055.630	AS	602
4051.549	AS	578	4053.041	AS	571	4055.147	AS	599	4055.631	AS	602
4051.550	AS	579	4053.042	AS	571	4055.149	AS	599	4055.632	AS	602
4051.551	AS	579	4053.043	AS	571	4055.150	AS	599	4055.633	AS	602
4051.597	AS	578	4053.044	AS	571	4055.154	AS	599	4055.634	AS	602
4051.598	AS	578	4053.045	AS	571	4055.160	AS	599	4055.660	AS	603
4051.599	AS	578	4053.046	AS	571	4055.161	AS	599	4055.661	AS	603
4051.600	AS	579	4053.047	AS	571	4055.163	AS	599	4055.662	AS	603
4051.601	AS	579	4053.300	AS	572	4055.180	AS	600	4055.663	AS	603
4051.602	AS	579	4053.310	AS	573	4055.212	AS	594	4055.664	AS	603
4051.603	AS	579	4053.400	AS	572	4055.215	AS	594	4055.665	AS	603
4051.604	AS	580	4053.410	AS	572	4055.216	AS	594	4055.690	AS	603
4051.605	AS	580	4053.420	AS	572	4055.218	AS	594	4055.700	AS	640
4051.638	AS	582	4053.450	AS	569	4055.220	AS	594	4055.710	AS	641
4051.641	AS	582	4053.500	AS	565	4055.222	AS	594	4055.712	AS	644
4051.644	AS	582	4054.000	AS	575	4055.225	AS	594	4055.714	AS	645
4051.647	AS	582	4054.001	AS	575	4055.228	AS	594	4055.720	AS	644
4051.695	AS	578	4054.002	AS	574	4055.232	AS	594	4055.740	AS	643
4051.696	AS	579	4054.003	AS	574	4055.237	AS	594	4055.741	AS	643
4051.697	AS	579	4054.004	AS	575	4055.240	AS	594	4055.742	AS	643
4051.698	AS	580	4054.008	AS	575	4055.247	AS	594	4055.743	AS	643
4052.000	AS	590	4054.020	AS	576	4055.250	AS	594	4055.744	AS	643
4052.001	AS	568	4054.021	AS	576	4055.254	AS	594	4055.745	AS	643
4052.003	AS	568	4054.023	AS	576	4055.260	AS	594	4055.746	AS	643
4052.004	AS	568	4054.024	AS	576	4055.263	AS	594	4055.747	AS	643
4052.007	AS	568	4054.030	AS	574	4055.322	AS	600	4055.748	AS	643
4052.011	AS	568	4054.080	AS	575	4055.345	AS	600	4055.749	AS	643
4052.014	AS	568	4054.081	AS	575	4055.346	AS	600	4055.750	AS	643
4052.018	AS	568	4054.140	AS	577	4055.350	AS	600	4055.770	AS	643
4052.021	AS	568	4054.141	AS	577	4055.368	AS	600	4055.771	AS	643
4052.022	AS	568	4054.300	AS	583	4055.392	AS	600	4055.772	AS	643
4052.031	AS	568	4054.305	AS	583	4055.400	AS	601	4055.773	AS	643
4052.032	AS	568	4054.310	AS	583	4055.401	AS	601	4055.774	AS	643
4052.038	AS	568	4054.315	AS	583	4055.402	AS	601	4055.775	AS	643
4052.053	AS	568	4054.400	AS	583	4055.403	AS	601	4055.776	AS	643
4052.054	AS	568	4054.405	AS	583	4055.440	AS	601	4055.777	AS	643
4052.055	AS	568	4054.410	AS	584	4055.441	AS	601	4055.778	AS	643
4052.056	AS	568	4054.600	AS	585	4055.460	AS	602	4055.779	AS	643
4052.058	AS	568	4054.650	AS	585	4055.461	AS	602	4055.780	AS	643
4052.101	AS	566	4054.660	AS	585	4055.463	AS	602	4055.791	AS	644
4052.102	AS	566	4054.700	AS	586	4055.465	AS	602	4055.800	AS	642
4052.104	AS	566	4054.750	AS	585	4055.480	AS	595	4055.806	AS	645
4052.106	AS	566	4054.800	AS	587	4055.481	AS	595	4055.807	AS	645
4052.107	AS	566	4054.850	AS	587	4055.512	AS	596	4114.000	PS	955
4052.121	AS	566	4054.860	AS	587	4055.515	AS	596	4115.000	PS	955
4052.122	AS	566	4054.870	AS	586	4055.516	AS	596	4115.500	CM	955
4052.131	AS	566	4054.900	AS	588	4055.518	AS	596	4116.000	PS	955
4052.132	AS	566	4055.000	AS	592	4055.520	AS	596	4116.500	CM	955
4052.141	AS	566	4055.010	AS	592	4055.522	AS	596	4118.000	PS	955
4052.142	AS	566	4055.020	AS	592	4055.525	AS	596	4118.500	CM	955
4052.200	AS	569	4055.041	AS	592	4055.528	AS	596	4119.000	PS	1003
4052.201	AS	569	4055.070	AS	593	4055.532	AS	596	4120.000	PS	954
4052.202	AS	569	4055.080	AS	593	4055.537	AS	596	4123.000	PS	955
4052.210	AS	567	4055.085	AS	593	4055.540	AS	596	4124.000	PS	955
4052.211	AS	567	4055.115	AS	599	4055.547	AS	596	4127.010	SZ	1024

List of model numbers

4133.000 to 5307.154

Model No.		Page	Model No.		Page	Model No.		Page	Model No.		Page
4133.000	TS	1001	4594.000	TS	952	5301.310	VX	914	5302.030	VX	1087
4134.000	TS	1001	4595.000	TS	967	5301.312	VX	914	5302.031	VX	1087
4140.000	SZ	1025	4596.000	TS	994	5301.315	VX IT	904	5302.032	VX	1087
4140.810	SZ	1025	4597.000	SZ	999	5301.317	VX IT	904	5302.033	VX	1087
4140.820	SZ	1025	4598.000	TS	952	5301.319	VX IT	904	5302.034	VX	1087
4140.830	SZ	1025	4599.000	TS	952	5301.321	VX IT	904	5302.035	DK	1088
4140.840	SZ	1025	4599.100	TS	952	5301.325	VX	894	5302.036	VX	1068
4157.000	SZ	1003	4599.200	TS	952	5301.326	VX	892	5302.037	VX	1005
4162.000	TS	1003	4612.000	PS	892	5301.330	VX	897	5302.038	VX	1063
4163.000	TS	1003	4638.600	PS	953	5301.331	VX	897	5302.041	SK	546
4164.500	VX	1002	4638.800	PS	953	5301.332	VX	897	5302.043	DK	1074
4165.500	VX	1002	4650.150	PC	252	5301.333	VX	897	5302.044	DK	1063
4166.500	VX	1002	4694.000	TS	952, 994	5301.334	VX	898	5302.046	DK	1069
4169.000	SZ	994	4695.000	TS	952, 994	5301.335	VX	898	5302.051	DK	1068
4170.000	SZ	994	4696.000	TS	952, 994	5301.336	VX	897	5302.052	DK	1068
4171.000	SZ	994	4697.000	TS	952, 994	5301.337	VX	897	5302.053	DK	1068
4172.000	SZ	994	4911.000	TS	910	5301.338	VX	897	5302.100	VX IT	1081
4173.000	SZ	994	4911.100	TS	910	5301.341	VX	897	5302.101	VX IT	1081
4174.000	SZ	994	4912.000	TS	910	5301.344	VX	897	5302.102	VX IT	1081
4175.000	SZ	994	4916.000	TS	910	5301.347	VX	897	5302.103	VX IT	1081
4176.000	SZ	994	4918.000	TS	910	5301.348	VX	898	5302.104	VX IT	1081
4177.000	SZ	994	4920.000	TS	910	5301.350	TS	900	5302.105	VX IT	1081
4178.000	SZ	994	4933.000	SZ	997	5301.400	VX	951	5302.106	VX IT	1081
4179.000	SZ	1003	4934.000	SZ	997	5301.401	VX	951	5302.107	VX IT	1081
4180.000	SZ	1003	4935.000	SZ	997	5301.403	VX	951	5302.108	VX IT	1081
4182.000	SZ	1002	4937.000	SZ	997	5301.423	VX IT	920	5302.109	VX IT	1081
4199.000	TS	1001	4943.000	SZ	996	5301.437	DK	920	5302.110	VX IT	1082
4309.000	TS	994	4944.000	SZ	996	5301.438	DK	920	5302.111	VX IT	1083
4311.000	SZ	1044	4945.000	SZ	996	5301.446	DK	922	5302.112	VX IT	1083
4315.800	SZ	1026	4946.000	SZ	996	5301.450	DK	922	5302.120	VX	1066
4315.810	SZ	1026	4947.000	SZ	996	5301.453	DK	922	5302.122	VX	1066
4315.820	SZ	1026	5001.050	CM	995	5301.515	VX	894	5302.123	IT	1084
4315.830	SZ	1026	5001.051	CM	995	5301.516	VX	894	5302.124	IT	1084
4315.840	SZ	1026	5001.052	CM	995	5301.518	VX	894	5302.152	VX IT	1082
4315.850	SZ	1026	5001.053	CM	995	5301.540	DK	921	5302.153	VX IT	1082
4315.860	SZ	1026	5001.054	CM	995	5301.542	DK	921	5302.154	VX IT	1082
4316.000	SZ	1044	5001.075	CM	981	5301.561	DK	922	5302.155	VX IT	1082
4317.000	SZ	1044	5001.080	CM	1059	5301.571	DK	922	5302.156	VX IT	1082
4318.000	SZ	1044	5001.081	CM	1059	5301.602	DK	921	5302.157	VX IT	1082
4319.090	SZ	1061	5001.082	CM	1059	5301.612	DK	921	5302.160	VX IT	1082
4319.120	SZ	1061	5001.083	CM	1059	5301.652	DK	923	5302.161	VX IT	1083
4319.160	SZ	1061	5001.130	CM	157, 163	5302.000	DK	1095	5302.164	VX IT	1083
4319.200	SZ	1061	5001.140	CM	158, 163	5302.001	DK	1095	5302.166	VX IT	1083
4333.120	TS	974	5001.160	CM	159, 163	5302.002	DK	1095	5302.167	VX IT	1083
4333.160	TS	974	5001.370	CM	995	5302.003	DK	1095	5302.169	VX IT	1082
4333.180	TS	974	5301.235	VX	902	5302.004	DK	1095	5302.170	VX IT	1084
4348.500	VX	1028	5301.236	VX	903	5302.005	DK	1095	5302.200	DK	1093
4393.000	SZ	994	5301.242	VX	903	5302.006	DK	1095	5302.201	IT	1093
4394.000	TS	996	5301.243	VX	903	5302.007	DK	1095	5302.202	DK	1074
4395.000	TS	996	5301.244	VX	903	5302.008	DK	1095	5302.203	DK	1065
4396.000	TS	996	5301.245	VX	903	5302.009	DK	1095	5302.204	DK	1097
4396.500	TS	996	5301.246	VX	903	5302.010	DK	1094	5302.205	DK	1115
4398.000	TS	996	5301.250	VX	902	5302.011	DK	1094	5302.322	VX	1066
4398.500	TS	996	5301.254	VX	902	5302.012	DK	1094	5303.114	VX	687
4531.001	VX	1089	5301.257	VX	902	5302.013	DK	1094	5303.124	VX	692
4532.000	SZ	999	5301.261	VX	902	5302.014	DK	1094	5303.134	VX	696
4538.000	TS	956	5301.264	VX	902	5302.015	DK	1094	5303.154	VX	697
4540.000	TS	915	5301.265	VX	902	5302.016	DK	1094	5304.116	VX	687
4568.000	SZ	964	5301.270	VX IT	904	5302.017	DK	1094	5304.126	VX	692
4568.500	SZ	964	5301.274	VX IT	904	5302.020	VX	1063	5305.124	VX	693
4579.000	TS	994	5301.281	VX IT	904	5302.021	VX	1063	5306.122	VX	693
4583.000	SZ	956	5301.284	VX IT	904	5302.022	VX	1063	5306.190	VX	699
4583.500	TS	956	5301.287	VX IT	904	5302.025	VX	1063	5307.114	VX	687
4590.700	TS	971	5301.291	VX IT	904	5302.026	IT	1074	5307.124	VX	693
4591.700	TS	971	5301.300	VX IT	904	5302.027	DK	1035	5307.134	VX	696
4592.700	TS	971	5301.303	VX IT	904	5302.028	VX	1035	5307.154	VX	697

List of model numbers

5307.157 to 6372.552

Model No.		Page	Model No.		Page	Model No.		Page	Model No.		Page
5307.157	VX	698	5501.410	DK	1086	6013.000	CP	1106	6206.820	CP	195
5307.190	VX	699	5501.420	DK	1086	6013.100	CP	1106	6206.850	CP	210
5308.113	VX	687	5501.430	DK	1086	6016.200	CP	968	6206.870	CP	210
5308.123	VX	693	5501.440	DK	1086	6027.010	CP	1107	6206.900	CP	1125
5308.190	VX	699	5501.450	DK	1086	6028.010	CP	1107	6212.025	CP	199
5308.813	VX	689	5501.460	DK	1088	6028.014	CP	1107	6212.050	CP	199
5308.823	VX	695	5501.615	DK	1010	6028.015	CP	1107	6212.060	CP	206
5309.116	VX	687	5501.625	DK	1010	6028.016	CP	1107	6212.065	CP	206
5309.126	VX	694	5501.635	DK	1010	6028.500	CP	1107	6212.100	CP	199
5309.136	VX	696	5501.655	DK	1008	6028.510	CP	1107	6212.110	CP	199
5309.156	VX	697	5501.665	DK	1008	6028.530	CP	1107	6212.120	CP	206
5309.166	VX	691	5501.675	DK	1008	6028.540	CP	1107	6212.150	CP	199
5309.190	VX	699	5501.685	DK	1008	6052.000	CP	1060	6212.200	CP	199
5309.816	VX	689	5501.695	DK	1008	6052.500	CP	1048	6212.210	CP	199
5309.826	VX	695	5501.705	DK	1008	6053.000	CP	1108	6212.300	CP	199
5310.118	VX	687	5501.715	DK	1008	6053.210	CP	1108	6212.320	CP	199
5310.128	VX	693	5501.725	DK	1008	6053.300	CP	1108	6212.380	CP	199
5310.818	VX	689	5501.730	DK	1011	6053.500	CP	1108	6212.500	CP	199
5311.116	VX	687	5501.895	DK	1085	6053.800	CP	1108	6212.520	CP	203
5311.126	VX	694	5501.900	DK	1091	6058.000	CP	1108	6212.540	CP	208
5311.816	VX	689	5502.010	DK	790	6058.500	CP	1108	6212.600	CP	199
5311.826	VX	695	5502.020	DK	790	6106.100	CP	211	6212.620	CP	199
5312.114	VX	688	5502.110	DK	1092	6106.110	CP	214	6212.640	CP	199
5312.124	VX	694	5502.115	DK	1069	6106.200	CP	211	6212.680	CP	199
5313.113	VX	688	5502.155	DK	1062	6106.300	CP	212	6212.700	CP	199
5313.813	VX	690	5502.205	DK	1072	6106.400	CP	211	6212.720	CP	199
5314.116	VX	688	5502.225	DK	1073	6106.500	CP	213	6212.740	CP	199
5314.126	VX	694	5502.235	DK	1073	6107.000	CP	1105	6212.760	CP	199
5314.816	VX	690	5502.245	DK	1073	6107.100	CP	1105	6212.780	CP	199
5315.118	VX	688	5502.305	DK	1091	6107.200	CP	1105	6212.800	CP	199
5315.818	VX	690	5502.325	DK	1091	6108.000	CP	1003	6212.820	CP	199
5316.116	VX	688	5502.405	DK	1064	6112.500	CP	213	6212.900	CP	1125
5316.816	VX	690	5820.600	SE	143	6141.200	IW	212	6218.050	CP	203
5325.121	VX	692	5821.600	SE	143	6143.310	CP	214	6218.100	CP	203
5325.190	VX	699	5822.600	SE	144	6146.100	CP	211	6218.110	CP	203
5326.121	VX	692	5823.600	SE	144	6146.200	CP	211	6218.150	CP	203
5326.131	VX	696	5824.600	SE	145	6146.300	CP	211	6218.200	CP	203
5326.190	VX	699	5825.600	SE	145	6147.000	CP	214	6218.210	CP	203
5327.121	VX	692	5830.600	SE	143	6148.000	CP	893	6218.300	CP	203
5327.190	VX	699	5830.680	SE	147	6205.100	CP	1000	6218.600	CP	203
5328.123	VX	693	5831.600	SE	144	6206.025	CP	195	6218.620	CP	203
5328.190	VX	699	5831.680	SE	147	6206.050	CP	195	6218.640	CP	203
5329.111	VX	687	5832.600	SE	144	6206.100	CP	195	6218.700	CP	203
5329.121	VX	693	5833.600	SE	144	6206.110	CP	195	6218.740	CP	203
5329.131	VX	696	5834.600	SE	144	6206.200	CP	195	6218.820	CP	203
5329.190	VX	699	5834.680	SE	147	6206.300	CP	195	6315.150	AX	179
5330.113	VX	687	5840.600	SE	145	6206.320	CP	195	6315.250	AX	179
5330.123	VX	693	5841.600	SE	145	6206.340	CP	195	6315.350	AX	179
5330.133	VX	696	5842.600	SE	146	6206.350	CP	210	6315.450	AX	179
5330.190	VX	699	5843.600	SE	145	6206.360	CP	195	6315.650	AX	179
5331.113	VX	687	5844.600	SE	145	6206.380	CP	195	6320.050	AX	179
5331.190	VX	699	5845.600	SE	145	6206.400	CP	195	6320.350	AX	179
5332.818	VX	690	5846.600	SE	146	6206.420	CP	209	6320.450	AX	179
5333.816	VX	690	5850.600	SE	249	6206.440	CP	195	6320.550	AX	179
5334.813	VX	690	5850.680	SE	250	6206.460	CP	209	6320.650	AX	179
5335.816	VX	690	5851.600	SE	249	6206.480	CP	207	6321.010	SM	1115
5366.050	PC	164	5852.600	SE	249	6206.490	CP	207	6321.050	AX	180
5366.150	PC	164	5852.680	SE	250	6206.500	CP	208	6340.000	CP	181
5366.250	PC	164	5853.600	SE	249	6206.550	CP	210	6340.100	CP	181
5366.350	PC	164	5853.680	SE	250	6206.600	CP	195	6340.300	CP	181
5366.450	PC	165	5854.600	SE	249	6206.620	CP	195	6340.400	CP	181
5368.050	PC	165	5855.600	SE	249	6206.640	CP	195	6341.000	CP	969
5380.830	VX	701	6002.000	CP	1113	6206.650	CP	214	6372.541	CP	172
5381.830	VX	701	6002.130	SM	1110	6206.700	CP	195	6372.542	CP	172
5386.050	PC	165	6003.000	CP	1114	6206.740	CP	195	6372.543	CP	172
5501.400	DK	1086	6005.500	CP	969	6206.800	CP	195	6372.552	CP	172

List of model numbers

6372.553 to 7161.700

Model No.		Page	Model No.		Page	Model No.		Page	Model No.		Page
6372.553	CP	172	6721.500	TP	158	7030.233	IT	813	7094.110	DK	1098
6372.562	CP	172	6722.500	TP	159	7030.262	VX IT	817, 919	7094.120	DK	1098
6372.563	CP	172	6723.500	TP	160	7030.263	VX IT	817, 919	7094.130	DK	1098
6375.010	CP	1103	6730.030	TP	160, 163	7030.272	VX IT	817, 919	7094.140	DK	1098
6380.000	CP	174	6730.100	TP	157, 163	7030.273	VX IT	817, 919	7097.000	DK	1060
6380.020	CP	174	6730.110	TP	158, 163	7030.282	VX IT	817, 919	7097.220	DK	1060
6380.040	CP	174	6730.120	TP	159, 163	7030.283	VX IT	817, 919	7097.260	DK	1060
6380.400	CP	174	6730.130	TP	160, 163	7030.400	DK	807	7097.300	DK	1060
6380.410	CP	174	6730.310	TP	982	7030.430	DK	807	7097.340	DK	1060
6380.510	CP	174	6730.330	TP	982	7030.440	DK	807	7098.000	DK	1060
6380.610	CP	174	6730.340	TP	982	7030.480	DK	818	7098.100	DK	1060
6385.010	CP	1103	6731.120	TP	163	7030.490	DK	818	7099.000	DK	1060
6446.030	SM	1111	6740.600	TP	161	7030.501	DK	817	7100.200	IT	870
6450.010	SM	1109	6742.600	TP	161	7030.571	DK	820	7100.221	IT	870
6450.020	SM	1109	6746.600	TP	161	7030.601	IT	946	7100.312	DK	871
6450.050	SM	1109	6748.600	TP	161	7030.611	IT	946	7100.401	IT	871
6450.060	SM	1109	6900.000	IW	167	7030.621	IT	815, 947	7100.501	IT	871
6450.070	SM	1109	6900.100	IW	167	7030.624	IT	948	7100.911	IT	872
6450.170	SM	1109	6900.400	IW	167	7030.628	IT	814	7100.912	IT	872
6501.000	CP	187	6900.410	IW	167	7030.690	DK	815	7100.913	IT	872
6501.020	CP	187	6901.100	IW	167	7030.692	IT	948	7100.914	IT	872
6501.050	CP	187	6902.100	IW	167	7030.695	IT	948	7100.915	IT	872
6501.070	CP	187	6902.300	IW	167	7030.950	IT	821	7100.921	IT	872
6501.110	CP	187	6902.310	IW	212	7044.010	DK	1070	7100.922	IT	872
6501.120	CP	187	6902.700	IW	1007	7044.020	DK	1071	7100.923	IT	872
6501.130	CP	187	6902.770	IW	1046	7044.110	DK	1069	7100.924	IT	872
6501.140	CP	187	6902.950	IW	1116	7044.113	DK	1070	7100.925	IT	872
6501.150	CP	187	6902.960	IW	1007	7044.120	DK	1069	7100.931	IT	873
6501.160	CP	187	6902.980	IW	1007	7044.123	DK	1070	7100.932	IT	873
6505.100	CP	1107	6903.200	IW	1116	7044.130	DK	1069	7100.933	IT	873
6505.200	CP	1107	7000.620	TE	1008	7044.133	DK	1070	7100.934	IT	873
6505.500	CP	1107	7000.625	DK	1009	7044.140	DK	1069	7100.935	IT	873
6514.200	CP	1112	7000.630	DK	1041	7044.143	DK	1070	7100.951	IT	873
6535.010	CP	254	7000.672	TE	895	7044.150	DK	1069	7100.961	IT	872
6536.010	CP	254	7000.675	TE	1036	7044.153	DK	1070	7100.962	IT	872
6538.010	CP	254	7000.684	TE	751	7044.160	DK	1069	7100.963	IT	873
6539.010	CP	254	7000.685	DK	1066	7044.163	DK	1070	7109.035	SK	546
6660.010	CP	189	7000.688	DK	752	7044.170	DK	1069	7111.000	DK	1064
6660.050	CP	189	7000.990	DK	1099	7044.173	DK	1070	7111.212	DK	1067
6663.000	CP	189	7030.000	DK	805	7044.178	DK	1071	7111.214	DK	1067
6663.400	CP	189	7030.010	DK	805	7044.210	DK	1071	7111.222	DK	1067
6663.500	CP	189	7030.040	DK	806	7044.211	DK	1071	7111.224	DK	1067
6664.000	CP	189	7030.050	DK	806	7044.230	DK	1071	7111.300	DK	1062
6664.100	CP	189	7030.051	DK	820	7044.231	DK	1071	7111.310	DK	1062
6664.300	CP	189	7030.060	DK	818	7044.240	DK	1071	7111.350	DK	1062
6664.500	CP	189	7030.071	DK	820	7044.241	DK	1071	7111.900	DK	1064
6665.000	CP	189	7030.080	DK	818	7050.035	DK	1102	7112.000	DK	1064
6665.500	CP	189	7030.087	DK	819	7050.100	DK	1102	7113.000	DK	1036
6681.000	CP	253	7030.088	DK	819	7061.000	DK	1011	7115.000	DK	1011
6700.600	TP	157	7030.090	DK	818	7063.200	DK	1072	7116.500	DK	1065
6701.600	TP	158	7030.091	DK	818	7063.740	DK	1087	7119.140	DK	1009
6702.600	TP	159	7030.092	DK	818	7063.750	IT	1089	7119.250	DK	1010
6703.600	TP	160	7030.093	DK	818	7063.752	IT	1089	7119.400	DK	1010
6704.600	TP	157	7030.094	DK	818	7064.000	DK	1011	7151.005	DK	1093
6705.600	TP	158	7030.095	DK	818	7065.000	DK	1011	7151.035	DK	1093
6706.600	TP	159	7030.100	DK	808	7066.000	DK	1011	7151.300	DK	1097
6707.600	TP	160	7030.110	DK	807	7066.700	DK	1011	7152.005	DK	1093
6710.500	TP	157	7030.111	DK	807	7072.100	DK	1047	7152.035	DK	1093
6711.500	TP	158	7030.120	DK	807	7072.200	DK	1055	7153.005	DK	1093
6712.500	TP	159	7030.128	DK	808	7072.220	DK	1061	7153.035	DK	1093
6713.500	TP	160	7030.130	DK	807	7072.230	DK	1061	7156.005	DK	1093
6714.500	TP	157	7030.140	DK	807	7072.240	DK	1061	7156.035	DK	1093
6715.500	TP	158	7030.150	DK	807	7077.000	DK	1060	7157.035	DK	1093
6716.500	TP	159	7030.190	DK	807	7078.000	DK	1060	7159.017	DK	1072
6717.500	TP	160	7030.202	DK	812	7081.000	DK	1011	7161.000	DK	1011
6720.500	TP	157	7030.223	DK	813	7094.100	DK	1098	7161.700	DK	1011

List of model numbers

7163.560 to 7979.131

Model No.		Page	Model No.		Page	Model No.		Page	Model No.		Page
7163.560	DK	1011	7338.221	DK	824	7544.000	DK	1036	7856.321	DK	745
7163.565	DK	1011	7338.321	DK	825	7545.000	DK	1036	7856.323	DK	745
7164.035	DK	1006	7391.000	DK	709	7546.000	DK	1036	7859.000	DK	1027
7165.035	DK	1006	7396.000	DK	709	7547.000	DK	1036	7859.010	DK	1027
7166.035	DK	1006	7400.000	DK	709	7548.000	DK	1036	7859.020	DK	1027
7166.735	DK	1006	7401.000	DK	1079	7548.210	IT	1034	7859.050	DK	747
7169.535	DK	1101	7402.000	DK	1079	7549.000	DK	1037	7859.053	DK	747
7170.535	DK	1100	7445.000	DK	709	7641.350	AX IT	719	7859.060	DK	751
7178.535	DK	1101	7451.000	DK	720	7643.350	AX IT	719	7859.065	DK	751
7184.035	DK	1006	7462.000	DK	1101	7645.350	AX IT	719	7859.080	DK	746
7185.035	DK	1006	7463.100	DK	1101	7646.400	AX IT	719	7859.081	DK	746
7186.035	DK	1006	7463.200	DK	1101	7688.000	DK	268	7859.090	DK	746
7186.735	DK	1006	7464.035	DK	1006	7696.000	DK	268	7859.120	DK	748
7200.210	DK	819	7465.035	DK	1006	7698.000	DK	268	7859.130	DK	748
7200.215	DK	819	7466.035	DK	1006	7705.035	DK	1055	7859.410	DK	750
7200.216	DK	819	7466.735	DK	1006	7705.110	DK	949	7859.420	DK	750
7200.217	DK	819	7470.535	DK	1100	7705.120	DK	949	7859.430	DK	750
7200.810	DK	949	7474.535	DK	1101	7705.235	EL	1054	7888.390	TE	704
7220.500	DK	1066	7478.535	DK	1101	7706.135	DK	716	7888.410	TE	704
7220.600	DK	1064	7480.035	DK	1043	7709.135	DK	716	7888.430	TE	704
7240.110	DK	1040	7480.300	DK	1043	7709.535	DK	715	7888.440	TE	704
7240.120	DK	1040	7484.035	DK	1006	7709.735	DK	715	7888.460	TE	705
7240.200	DK	1040	7485.035	DK	1006	7712.135	DK	716	7888.500	TE	704
7240.201	DK	1040	7486.035	DK	1006	7715.135	DK	716	7888.510	TE	704
7240.210	DK	1040	7486.735	DK	1006	7715.535	DK	715	7888.520	TE	705
7240.220	DK	1040	7494.000	DK	1079	7715.735	DK	715	7888.530	TE	705
7240.230	DK	1040	7495.000	DK	893	7721.135	DK	716	7888.532	TE	705
7240.240	DK	1040	7501.000	DK	712	7721.535	DK	715	7888.610	DK	963
7240.260	DK	1040	7507.000	DK	713	7721.735	DK	715	7888.612	DK	963
7240.280	DK	1040	7507.010	DK	713	7752.950	DK	1037	7888.615	TE	1024
7240.301	DK	1041	7507.020	DK	714	7824.540	DK	913	7888.640	TE	916
7240.310	DK	1040	7507.030	DK	714	7825.375	DK	1055	7888.652	TE	903
7240.330	DK	1040	7507.100	DK	713	7826.605	DK	963	7888.653	TE	903
7240.510	DK	1040	7507.110	DK	713	7826.665	DK	963	7888.840	TE	706
7241.005	DK	1099	7507.120	DK	714	7826.685	DK	963	7888.850	TE	706
7241.024	DK	1100	7507.200	DK	714	7826.750	DK	791	7888.875	TE	707
7241.045	DK	1100	7507.210	DK	714	7826.805	DK	963	7888.882	TE	707
7246.010	DK	1091	7507.220	DK	714	7826.825	TS	963	7888.892	TE	707
7246.030	DK	1091	7507.706	DK	1085	7826.865	DK	963	7888.940	TE	708
7246.060	DK	1091	7507.709	DK	1085	7826.885	DK	963	7888.944	TE	708
7246.100	DK	1090	7507.712	DK	1085	7827.544	DK	1096	7888.950	DK	963
7246.400	DK	1090	7507.715	DK	1085	7829.150	DK	1035	7950.100	DK	1085
7246.420	DK	1084	7507.718	DK	1085	7829.200	DK	1034	7950.150	DK	957
7246.500	DK	1097	7507.721	DK	1085	7831.472	TS	1065	7950.200	DK	957
7257.005	DK	1072	7507.740	DK	892	7856.005	DK	745	7955.010	DK	752
7257.035	DK	1072	7507.750	DK	891	7856.006	DK	745	7955.015	DK	752
7257.100	DK	1072	7507.755	DK	891	7856.008	DK	745	7963.310	DK	1088
7257.105	DK	1072	7507.760	SK	791	7856.010	DK	745	7963.410	DK	1088
7257.200	DK	1072	7526.750	TE	899	7856.013	DK	752	7963.510	DK	1088
7280.035	DK	1042	7526.755	TE	899	7856.014	DK	751	7963.610	DK	1088
7280.100	DK	1042	7526.760	TE	899	7856.020	DK	745	7963.710	DK	1088
7281.035	DK	1115	7526.770	TE	899	7856.025	DK	751	7967.000	DK	964
7281.200	DK	1114	7526.780	TE	899	7856.026	DK	751	7979.001		736
7282.035	DK	1091	7526.785	TE	899	7856.027	DK	751	7979.020	DK	752
7282.135	DK	1091	7526.790	TE	899	7856.030	DK	751	7979.102	DK	733
7283.035	DK	1091	7526.795	TE	899	7856.070	DK	748	7979.103	DK	733
7296.000	DK	1079	7526.800	TE	899	7856.080	DK	748	7979.104	DK	733
7297.000	DK	1079	7526.820	TE	899	7856.082	DK	748	7979.110	DK	733
7298.000	DK	1079	7526.829	TE	899	7856.090	DK	748	7979.111	DK	733
7299.000	DK	1079	7526.834	TE	899	7856.100	DK	748	7979.112	DK	733
7320.570	DK	808	7526.850	TE	899	7856.120	DK	748	7979.113	DK	733
7320.700	DK	812, 950	7526.860	TE	899	7856.170	DK	751	7979.114	DK	733
7320.814	DK	819	7526.964	TS	999	7856.191	DK	748	7979.115	DK	733
7338.121	DK	823	7541.000	DK	1036	7856.220	DK	748	7979.116	DK	733
7338.130	DK	826	7542.000	DK	1036	7856.230	DK	748	7979.130	DK	733
7338.135	DK	826	7543.000	DK	1036	7856.240	DK	748	7979.131	DK	733

List of model numbers

7979.132 to 8609.203

Model No.		Page	Model No.		Page	Model No.		Page	Model No.		Page
7979.132	DK	733	7979.430	DK	735	7998.306	DK	851	8128.245	VX	901
7979.133	DK	733	7979.431	DK	735	7998.307	DK	851	8145.245	VX	901
7979.134	DK	733	7979.432	DK	735	7998.406	DK	850	8165.245	VX	901
7979.135	DK	733	7979.433	DK	735	7998.407	DK	850	8166.245	VX	901
7979.136	DK	733	7979.434	DK	735	7998.506	DK	851	8168.245	VX	901
7979.137	DK	733	7979.435	DK	735	7998.606	DK	851	8170.245	VX	901
7979.138	DK	733	7979.436	DK	735	7998.607	DK	851	8173.245	VX	901
7979.139	DK	733	7979.437	DK	735	7998.905	DK	850, 851	8175.245	VX	901
7979.140	DK	733	7979.438	DK	735	7998.906	DK	850, 851	8176.245	VX	901
7979.141	DK	733	7979.439	DK	735	7998.907	DK	850, 851	8184.245	VX	901
7979.142	DK	733	7979.440	DK	735	7998.908	DK	850, 851	8185.245	VX	901
7979.143	DK	733	7979.442	DK	735	7999.009	DK	844	8186.245	VX	901
7979.202	DK	733	7979.502	DK	734	7999.709	DK	846	8188.245	VX	901
7979.203	DK	733	7979.503	DK	734	8001.210	VX	896	8204.000	VX	123
7979.204	DK	733	7979.504	DK	734	8001.211	VX	896	8205.000	VX	124
7979.210	DK	733	7979.510	DK	734	8001.212	VX	896	8206.000	VX	125
7979.211	DK	733	7979.511	DK	734	8001.213	VX	896	8208.000	VX	126
7979.212	DK	733	7979.512	DK	734	8001.214	VX	896	8215.000	VX	117
7979.213	DK	733	7979.513	DK	734	8001.215	VX	896	8226.000	VX	127
7979.214	DK	733	7979.514	DK	734	8001.216	VX	896	8245.000	VX	118
7979.215	DK	733	7979.515	DK	734	8001.217	VX	896	8265.000	VX	119
7979.216	DK	733	7979.516	DK	734	8001.218	VX	896	8284.000	VX	120
7979.230	DK	733	7979.530	DK	734	8001.219	VX	896	8285.000	VX	121
7979.231	DK	733	7979.531	DK	734	8001.220	VX	896	8286.000	VX	122
7979.232	DK	733	7979.532	DK	734	8001.221	VX	896	8405.000	VX	124
7979.233	DK	733	7979.533	DK	734	8001.222	VX	896	8406.000	VX	125
7979.234	DK	733	7979.534	DK	734	8001.223	VX	896	8410.000	VX	130
7979.235	DK	733	7979.535	DK	734	8001.224	VX	896	8418.000	VX	130
7979.236	DK	733	7979.536	DK	734	8001.225	VX	896	8430.000	VX	130
7979.237	DK	733	7979.537	DK	734	8001.239	VX	896	8438.000	VX	130
7979.238	DK	733	7979.538	DK	734	8001.241	VX	896	8450.000	VX	245
7979.239	DK	733	7979.539	DK	734	8001.242	VX	896	8451.000	VX	245
7979.240	DK	733	7979.540	DK	734	8001.243	VX	896	8452.000	VX	245
7979.242	DK	733	7979.542	DK	734	8004.000	VX	123	8453.000	VX	244
7979.302	DK	734	7979.711	DK	753	8005.000	VX	124	8454.000	VX	243
7979.303	DK	734	7979.712	DK	753	8006.000	VX	125	8455.000	VX	244
7979.304	DK	734	7979.713	DK	753	8080.000	VX	120	8456.000	VX	243
7979.310	DK	734	7979.714	DK	753	8084.000	VX	120	8457.000	VX	244
7979.311	DK	734	7979.721	DK	754	8100.245	VX	901	8458.000	VX	246
7979.312	DK	734	7979.722	DK	754	8100.700	VX	884	8485.000	VX	121
7979.313	DK	734	7979.723	DK	754	8100.710	VX	886	8486.000	VX	122
7979.314	DK	734	7979.724	DK	754	8100.711	VX	886	8600.255	TS	884
7979.315	DK	734	7979.801	DK	735	8100.730	VX	991	8600.265	TS	884
7979.316	DK	734	7979.811	DK	735	8100.731	VX	991	8600.455	TS	884
7979.330	DK	734	7979.812	DK	735	8100.732	VX	991	8600.465	TS	884
7979.331	DK	734	7979.813	DK	735	8100.733	VX	991	8600.510	TS	884
7979.332	DK	734	7979.814	DK	735	8100.740	VX	993	8600.520	TS	884
7979.333	DK	734	7979.815	DK	735	8100.741	VX	993	8600.655	TS	884
7979.334	DK	734	7979.821	DK	735	8100.742	VX	993	8600.665	TS	884
7979.335	DK	734	7979.822	DK	735	8100.743	VX	993	8600.855	TS	884
7979.336	DK	734	7979.823	DK	735	8100.745	VX	993	8600.865	TS	884
7979.337	DK	734	7980.000	DK	790	8100.770	VX	893	8601.450	TS	891
7979.338	DK	734	7980.100	DK	790	8100.771	VX	893	8601.680	TS	891
7979.339	DK	734	7980.148	DK	790	8100.780	VX	892	8601.860	TS	1032
7979.340	DK	734	7990.103	DK	831	8102.245	VX	901	8604.000	VX	123
7979.342	DK	734	7990.203	DK	831	8104.245	VX	901	8605.000	VX	124
7979.402	DK	735	7990.206	DK	831	8105.245	VX	901	8606.000	VX	125
7979.403	DK	735	7990.208	DK	831	8106.245	VX	901	8608.000	VX	126
7979.404	DK	735	7990.303	DK	831	8106.260	VX	902	8609.140	TS	907
7979.410	DK	735	7990.306	DK	831	8106.760	VX	1028	8609.150	TS	907
7979.411	DK	735	7990.308	DK	831	8108.245	VX	901	8609.160	TS	907
7979.412	DK	735	7990.402	DK	831	8108.760	VX	1028	8609.170	TS	907
7979.413	DK	735	7990.502	DK	831	8115.245	VX	901	8609.200	VX	905
7979.414	DK	735	7998.106	DK	850	8120.245	VX	901	8609.201	VX	905
7979.415	DK	735	7998.107	DK	850	8122.245	VX	901	8609.202	VX	905
7979.416	DK	735	7998.206	DK	851	8126.245	VX	901	8609.203	VX	905

List of model numbers

8609.204 to 8640.004

Model No.		Page	Model No.		Page	Model No.		Page	Model No.		Page
8609.204	VX	905	8617.190	VX	991	8618.250	VX	937	8619.400	VX	1059
8609.205	VX	905	8617.200	VX	991	8618.251	VX	937	8619.410	VX	1059
8609.206	VX	905	8617.210	VX	991	8618.270	VX	937	8619.420	VX	1059
8609.207	VX	905	8617.351	VX	972	8618.280	VX	937	8619.430	VX	1059
8609.210	VX	906	8617.352	VX	973	8618.300	VX	941	8619.440	VX	1059
8609.211	VX	906	8617.353	VX	971	8618.301	VX	941	8619.450	VX	1059
8609.212	VX	906	8617.360	VX	973	8618.302	VX	941	8619.460	VX	1059
8609.213	VX	906	8617.370	VX	974	8618.303	VX	941	8619.500	VX	1075
8609.220	VX	908	8617.400	VX	974	8618.304	VX	941	8619.510	VX	1075
8609.230	VX	908	8617.401	VX	974	8618.305	VX	941	8619.520	VX	1075
8609.390	TS	907	8617.402	VX	974	8618.306	VX	941	8619.530	VX	1075
8610.605	TS	918	8617.500	VX	912	8618.307	VX	941	8619.540	VX	1075
8610.685	TS	918	8617.501	VX	912	8618.308	VX	941	8619.550	VX	1075
8610.805	TS	918	8617.502	VX	912	8618.330	VX	951	8619.600	VX	1076
8610.885	TS	918	8617.503	VX	912	8618.335	VX	951	8619.610	VX	1076
8611.020	TS	938	8617.505	VX	916	8618.340	VX	951	8619.700	VX	952, 990
8611.070	TS	938	8617.506	VX	913	8618.410	VX	957	8619.710	VX	952, 990
8611.080	TS	918	8617.507	VX	914	8618.420	VX	956	8619.720	VX	952, 990
8611.100	TS	941	8617.508	VX	913	8618.425	VX	956	8619.730	VX	952, 990
8611.110	TS	941	8617.510	VX	975	8618.430	VX	956	8619.740	VX	952
8611.120	TS	941	8617.520	VX	975	8618.450	VX	932	8619.750	VX	952, 990
8611.130	TS	941	8617.530	VX	975	8618.451	VX	932	8619.760	VX	990
8611.140	TS	941	8617.540	VX	975	8618.460	VX	937	8619.770	VX	990
8611.150	TS	941	8617.550	VX	975	8618.501	VX	960	8619.780	VX	990
8611.160	TS	941	8617.560	VX	975	8618.511	VX	960	8619.790	VX	990
8611.170	TS	941	8617.570	VX	975	8618.521	VX	960	8619.800	VX	1044
8611.180	TS	942	8617.580	VX	975	8618.531	VX	960	8619.801	VX	1044
8611.190	TS	942	8617.590	VX	975	8618.541	VX	960	8619.802	VX	1044
8611.200	TS	942	8617.600	VX	975	8618.600	VX	1032	8619.803	VX	1044
8611.220	TS	941	8617.610	VX	975	8618.800	VX	1045	8620.010	VX	883
8611.290	TS	938	8617.620	VX	975	8618.801	VX	1045	8620.011	VX	883
8611.300	PC	918	8617.630	VX	975	8618.802	VX	1045	8620.050	VX	886
8611.330	TS	938	8617.640	VX	975	8618.803	VX	1045	8620.051	VX	886
8611.340	TS	938	8617.650	VX	977	8618.804	VX	1045	8620.052	VX	886
8612.030	TS	992	8617.655	VX	978	8618.810	VX	1045	8620.053	VX	886
8612.040	TS	992	8617.660	VX	980	8618.811	VX	1045	8620.060	VX	886
8612.050	TS	992	8617.661	VX	980	8618.812	VX	1045	8620.061	VX	886
8612.060	TS	992	8617.662	VX	980	8618.813	VX	1045	8620.062	VX	886
8612.130	TS	992	8617.663	VX	980	8618.814	VX	1045	8620.063	VX	886
8612.140	TS	992	8617.664	VX	980	8618.820	VX	1029	8620.070	VX	887
8612.150	TS	992	8617.665	VX	980	8618.821	VX	1029	8620.071	VX	887
8612.160	TS	992	8617.700	VX	993	8618.822	VX	1029	8620.072	VX	887
8612.400	TS	998	8617.710	VX	993	8618.823	VX	1029	8620.080	VX	887
8612.410	TS	998	8617.720	VX	993	8619.010	VX	1077	8620.081	VX	887
8612.960	TS	997	8617.730	VX	993	8619.011	VX	1077	8620.082	VX	887
8612.980	TS	997	8617.750	SZ	995	8619.012	VX	1077	8620.090	VX	883
8613.151	VX	1089	8617.751	SZ	995	8619.013	VX	1077	8620.091	VX	883
8613.161	VX	1089	8617.760	SZ	995	8619.014	VX	1077	8620.092	VX	882
8613.181	VX	1089	8617.800	VX	996	8619.020	VX	1077	8620.093	VX	882
8615.000	VX	117	8617.810	VX	996	8619.021	VX	1077	8620.094	VX	882
8617.000	VX	990	8617.820	VX	996	8619.022	VX	1077	8620.095	VX	882
8617.010	VX	990	8617.830	VX	996	8619.023	VX	1077	8620.100	VX	883
8617.020	VX	990	8618.000	VX	917	8619.024	VX	1077	8620.400	VX	885
8617.030	VX	990	8618.010	VX	917	8619.030	VX	1077	8620.500	VX	928
8617.040	VX	990	8618.020	VX	917	8619.032	VX	1077	8620.501	VX	928
8617.050	VX	990	8618.030	VX	917	8619.033	VX	1077	8620.502	VX	928
8617.060	VX	990	8618.040	VX	917	8619.034	VX	1077	8620.520	VX	928
8617.100	VX	991	8618.050	VX	917	8619.040	VX	1078	8620.521	VX	928
8617.110	VX	991	8618.110	VX	917	8619.041	VX	1078	8620.900	VX	895
8617.120	VX	991	8618.120	VX	917	8619.042	VX	1078	8620.901	VX	895
8617.130	VX	991	8618.200	VX	937	8619.050	VX	1078	8626.000	VX	127
8617.140	VX	991	8618.201	VX	937	8619.270	VX	1078	8640.000	VX	881
8617.150	VX	991	8618.220	VX	937	8619.300	VX	1080	8640.001	VX	881
8617.160	VX	991	8618.230	VX	937	8619.310	VX	1080	8640.002	VX	881
8617.170	VX	991	8618.231	VX	937	8619.320	VX	1080	8640.003	VX	881
8617.180	VX	991	8618.240	VX	937	8619.330	VX	1081	8640.004	VX	881

List of model numbers

8640.005 to 9342.720

Model No.		Page	Model No.		Page	Model No.		Page	Model No.		Page
8640.005	VX	881	8807.010	VX	136	9303.000	KE	258	9340.760	SV	307
8640.006	VX	881	8807.020	VX	136	9304.000	KE	258	9340.770	SV	308
8640.007	VX	881	8808.000	VX	126	9305.000	KE	258	9340.780	SV	307
8640.008	VX	881	8815.000	VX	117	9306.000	KE	258	9340.790	SV	308
8640.009	VX	881	8826.000	VX	127	9320.020	SV	343	9340.820	SV	355
8640.020	VX	881	8840.100	VX	129	9320.030	SV	343	9340.830	SV	355
8640.021	VX	881	8840.110	VX	129	9320.060	SV	345	9340.850	SV	354
8640.022	VX	881	8840.120	VX	129	9320.070	SV	345	9340.860	SV	354
8640.023	VX	881	8840.130	VX	129	9320.120	SV	353	9340.870	SV	354
8640.024	VX	881	8845.000	VX	118	9320.150	SV	352	9340.880	SV	354
8640.025	VX	881	8865.000	VX	119	9340.000	SV	300	9340.890	SV	354
8640.026	VX	881	8880.000	VX	121	9340.004	SV	300	9340.905	SV	356
8640.027	VX	881	8881.000	VX	122	9340.010	SV	300	9340.910	SV	312
8640.030	VX	882	8884.000	VX	120	9340.030	SV	340	9340.930	SV	312
8640.031	VX	882	8885.000	VX	121	9340.040	SV	340	9340.950	SV	324
8640.032	VX	882	8886.000	VX	122	9340.050	SV	300	9341.000	SV	302
8640.033	VX	882	8951.000	VX	909	9340.070	SV	301	9341.050	SV	302
8640.034	VX	882	8951.010	VX	909	9340.074	SV	301	9341.070	SV	303
8640.035	VX	882	8951.020	VX	909	9340.090	SV	341	9341.100	SV	347
8640.036	VX	882	8951.030	VX	909	9340.100	SV	347	9341.110	SV	347
8640.040	VX	882	8952.000	VX	909	9340.110	SV	347	9341.120	SV	347
8640.041	VX	882	8952.010	VX	909	9340.120	SV	347	9341.130	SV	347
8640.042	VX	882	8952.020	VX	909	9340.130	SV	347	9341.140	SV	347
8640.043	VX	882	8952.030	VX	909	9340.134	SV	347	9341.170	SV	347
8640.044	VX	882	9055.310	DK	822	9340.140	SV	347	9342.000	SV	302
8640.045	VX	882	9055.312	DK	822	9340.170	SV	347	9342.004	SV	302
8640.046	VX	882	9055.410	DK	822	9340.200	SV	348	9342.030	SV	340
8645.000	VX	118	9055.412	DK	822	9340.210	SV	348	9342.050	SV	302
8665.000	VX	119	9101.210	GA	48	9340.214	SV	348	9342.070	SV	303
8684.000	VX	120	9102.210	GA	48	9340.220	SV	348	9342.074	SV	303
8685.000	VX	121	9104.210	GA	48	9340.224	SV	348	9342.100	SV	347
8686.000	VX	122	9105.210	GA	48	9340.230	SV	348	9342.110	SV	347
8700.030	VX	901	9105.700	GA	49	9340.260	SV	313	9342.120	SV	347
8700.040	VX	901	9106.210	GA	48	9340.270	SV	313	9342.130	SV	347
8700.050	VX	901	9107.210	GA	48	9340.280	SV	354	9342.134	SV	347
8700.140	TS	915	9108.210	GA	48	9340.290	SV	353	9342.140	SV	347
8700.150	TS	915	9108.700	GA	49	9340.300	SV	313	9342.170	SV	347
8700.160	TS	915	9110.210	GA	48	9340.310	SV	308	9342.200	SV	304
8701.180	TS	951	9110.700	GA	49	9340.320	SV	308	9342.210	SV	304
8800.130	TS	994	9111.210	GA	48	9340.340	SV	308	9342.220	SV	304
8800.190	TS	951	9112.210	GA	48	9340.350	SV	308	9342.224	SV	304
8800.695	VX	1028	9112.700	GA	49	9340.370	SV	308	9342.240	SV	304
8800.710	TS	951	9113.210	GA	48	9340.380	SV	308	9342.250	SV	305
8800.750	TS	1058	9113.700	GA	49	9340.390	SV	308	9342.254	SV	305
8800.751	TS	1058	9114.210	GA	48	9340.400	SV	308	9342.270	SV	305
8800.752	TS	1058	9116.210	GA	48	9340.410	SV	309	9342.280	SV	305
8800.753	TS	1058	9116.700	GA	49	9340.430	SV	309	9342.300	SV	305
8800.754	TS	1058	9117.210	GA	48	9340.450	SV	309	9342.310	SV	305
8800.755	VX	1058	9117.700	GA	49	9340.460	SV	308	9342.311	SV	351
8800.770	VX	1058	9118.210	GA	48	9340.470	SV	308	9342.314	SV	306
8800.825	TS	915	9118.700	GA	49	9340.510	SV	310	9342.320	SV	305
8800.845	TS	915	9119.210	GA	48	9340.520	SV	310	9342.321	SV	351
8800.855	TS	915	9121.122	GA	49	9340.530	SV	310	9342.324	SV	306
8800.865	TS	915	9121.160	GA	49	9340.550	SV	310	9342.400	SV	314
8800.875	VX	916	9121.230	GA	49	9340.560	SV	310	9342.410	SV	314
8800.885	TS	915	9123.000	GA	49	9340.610	SV	311	9342.500	SV	315
8800.900	PC	1007	9202.100	KE	260	9340.620	SV	311	9342.504	SV	317
8800.910	PC	1007	9203.100	KE	260	9340.630	SV	311	9342.510	SV	315
8800.920	PC	890	9204.100	KE	260	9340.650	SV	311	9342.514	SV	317
8801.000	TS	924	9205.100	KE	260	9340.660	SV	310	9342.540	SV	314
8801.010	TS	924	9206.100	KE	260	9340.700	SV	309	9342.550	SV	314
8801.260	TS	928	9207.100	KE	260	9340.710	SV	309	9342.560	SV	355
8804.000	VX	123	9208.100	KE	260	9340.720	SV	309	9342.570	SV	355
8805.000	VX	124	9209.100	KE	260	9340.730	SV	309	9342.610	SV	315
8806.000	VX	125	9301.000	KE	258	9340.740	SV	309	9342.640	SV	355
8807.000	VX	131	9302.000	KE	258	9340.750	SV	309	9342.720	SV	353

List of model numbers

9342.800 to 9666.060

Model No.		Page	Model No.		Page	Model No.		Page	Model No.		Page
9342.800	SV	354	9345.100	SV	339	9522.000	PK	45	9635.600	SV	293
9342.810	SV	354	9345.200	SV	339	9522.100	PK	45	9635.610	SV	293
9342.820	SV	354	9345.400	SV	339	9523.000	PK	45	9635.620	SV	293
9342.850	SV	352	9345.600	SV	315	9523.100	PK	45	9635.630	SV	293
9342.860	SV	352	9345.604	SV	317	9524.000	PK	45	9635.640	SV	293
9342.870	SV	352	9345.610	SV	315	9524.100	PK	45	9635.700	SV	290
9342.880	SV	352	9345.614	SV	317	9548.000	PK	47	9635.800	SV	292
9342.920	SV	352	9345.700	SV	316	9549.000	PK	47	9640.202	SV	401
9342.930	SV	352	9345.704	SV	318	9550.000	PK	47	9640.207	SV	401
9342.940	SV	352	9345.710	SV	316	9581.000	PK	47	9640.232	SV	401
9342.950	SV	352	9345.714	SV	318	9583.000	PK	47	9640.237	SV	401
9342.980	SV	352	9345.720	SV	316	9600.000	SV	294	9640.262	SV	401
9343.000	SV	327	9345.724	SV	318	9600.005	SV	340	9640.267	SV	401
9343.010	SV	327	9345.730	SV	316	9601.000	SV	294	9640.292	SV	401
9343.020	SV	329	9345.734	SV	318	9602.000	SV	294	9640.297	SV	401
9343.030	SV	329	9346.000	SV	335	9603.000	SV	294	9640.325	SV	403
9343.040	SV	331	9346.010	SV	335	9605.000	SV	294	9640.330	SV	403
9343.050	SV	331	9346.015	SV	336	9606.000	SV	294	9640.340	SV	403
9343.070	SV	333	9346.020	SV	335	9607.000	SV	294	9640.350	SV	403
9343.100	SV	328	9346.030	SV	335	9608.000	SV	294	9640.360	SV	401
9343.110	SV	328	9346.060	SV	335	9609.000	SV	294	9640.365	SV	401
9343.120	SV	330	9346.400	SV	358	9610.000	SV	294	9640.370	SV	403
9343.130	SV	330	9346.460	SV	357	9611.000	SV	294	9640.380	SV	403
9343.140	SV	332	9350.010	SV	343	9612.000	SV	294	9640.900	SV	404
9343.150	SV	332	9350.060	SV	343	9613.000	SV	294	9640.910	SV	404
9343.170	SV	333	9350.075	SV	343	9614.000	SV	296	9640.920	SV	404
9343.200	SV	328	9401.600	KE	259	9614.100	SV	296	9640.930	SV	404
9343.210	SV	328	9402.600	KE	259	9614.110	SV	296	9640.940	SV	404
9343.230	SV	330	9403.600	KE	259	9615.000	SV	296	9640.970	SV	403
9343.250	SV	332	9404.600	KE	259	9615.100	SV	296	9640.980	SV	403
9343.270	SV	333	9405.600	KE	259	9616.000	SV	297	9649.010	SV	401
9343.300	SV	328	9406.600	KE	259	9617.000	SV	297	9649.360	SV	401
9343.310	SV	328	9407.600	KE	259	9623.000	SV	353	9650.202	SV	402
9343.330	SV	330	9408.600	KE	259	9624.000	SV	294	9650.232	SV	402
9343.350	SV	332	9409.600	KE	259	9625.000	SV	296	9650.262	SV	402
9343.370	SV	333	9500.000	PK	44	9627.000	SV	297	9650.292	SV	402
9343.400	SV	334	9502.000	PK	44	9629.000	SV	297	9650.325	SV	403
9343.410	SV	334	9504.000	PK	44	9629.010	SV	296	9650.330	SV	403
9344.000	SV	327	9505.000	PK	44	9629.100	SV	295	9650.340	SV	403
9344.010	SV	327	9506.000	PK	44	9630.000	SV	295	9650.360	SV	402
9344.020	SV	329	9507.000	PK	44	9630.005	SV	295	9650.370	SV	403
9344.030	SV	329	9508.000	PK	44	9635.000	SV	284	9650.380	SV	403
9344.040	SV	331	9508.050	PK	46	9635.010	SV	284	9650.900	SV	404
9344.050	SV	331	9509.000	PK	44	9635.100	SV	289	9650.905	SV	404
9344.100	SV	328	9510.000	PK	44	9635.110	SV	289	9650.910	SV	404
9344.110	SV	328	9511.000	PK	44	9635.200	SV	285	9650.920	SV	404
9344.130	SV	330	9512.000	PK	44	9635.210	SV	285	9650.980	SV	403
9344.150	SV	332	9513.000	PK	44	9635.300	SV	287	9650.990	SV	403
9344.210	SV	328	9514.000	PK	45	9635.310	SV	287	9659.010	SV	401
9344.230	SV	330	9514.050	PK	46	9635.320	SV	287	9659.360	SV	402
9344.250	SV	332	9514.100	PK	45	9635.330	SV	287	9660.090	SV	408
9344.310	SV	328	9515.000	PK	45	9635.340	SV	287	9660.205	SV	405
9344.330	SV	330	9515.100	PK	45	9635.350	SV	287	9660.980	SV	404
9344.350	SV	332	9516.000	PK	45	9635.360	SV	287	9665.750	SV	962
9344.510	SV	358	9516.100	PK	45	9635.371	SV	286	9665.760	SV	962
9344.520	SV	357	9517.000	PK	45	9635.372	SV	286	9665.770	SV	962
9344.530	SV	357	9517.100	PK	45	9635.373	SV	286	9665.780	SV	962
9344.540	SV	357	9518.000	PK	45	9635.381	SV	286	9665.785	SV	962
9344.550	SV	357	9518.100	PK	45	9635.382	SV	286	9666.000	SV	421
9344.610	SV	357	9519.000	PK	45	9635.383	SV	286	9666.010	SV	421
9344.620	SV	357	9519.100	PK	45	9635.390	SV	288	9666.020	SV	421
9344.680	SV	357	9520.000	PK	45	9635.400	SV	291	9666.030	SV	421
9345.005	SV	338	9520.100	PK	45	9635.410	SV	291	9666.040	SV	421
9345.015	SV	338	9521.000	PK	46	9635.415	SV	291	9666.050	SV	421
9345.035	SV	338	9521.050	PK	46	9635.420	SV	291	9666.053	SV	421
9345.040	SV	337	9521.100	PK	45	9635.425	SV	291	9666.060	SV	421

List of model numbers

9666.063 to 9681.682

Model No.		Page	Model No.		Page	Model No.		Page	Model No.		Page
9666.063	SV	421	9666.712	SV	429	9676.977	SV	404	9677.640	SV	381
9666.070	SV	421	9666.722	SV	429	9676.981	SV	404	9677.650	SV	381
9666.073	SV	421	9666.723	SV	429	9676.982	SV	404	9677.700	SV	372
9666.080	SV	421	9666.724	SV	429	9676.983	SV	404	9677.705	SV	373
9666.090	SV	421	9666.732	SV	430	9676.986	SV	404	9677.710	SV	372
9666.100	SV	421	9666.740	SV	430	9676.987	SV	404	9677.715	SV	373
9666.110	SV	421	9666.753	SV	429	9677.000	SV	375	9677.730	SV	382
9666.120	SV	421	9666.754	SV	429	9677.010	SV	374	9677.740	SV	382
9666.130	SV	421	9666.756	SV	429	9677.015	SV	376	9677.750	SV	382
9666.133	SV	421	9666.757	SV	429	9677.025	SV	375	9677.760	SV	382
9666.140	SV	421	9666.801	SV	420	9677.060	SV	377	9677.770	SV	372
9666.143	SV	421	9666.811	SV	420	9677.065	SV	377	9677.780	SV	373
9666.150	SV	421	9666.821	SV	420	9677.070	SV	377	9677.790	SV	382
9666.160	SV	422	9666.831	SV	420	9677.075	SV	377	9677.792	SV	382
9666.170	SV	422	9666.841	SV	420	9677.080	SV	379	9677.794	SV	382
9666.180	SV	422	9666.851	SV	420	9677.085	SV	379	9677.796	SV	382
9666.190	SV	422	9666.902	SV	420	9677.100	SV	375	9677.798	SV	382
9666.200	SV	422	9666.912	SV	420	9677.110	SV	374	9677.810	SV	385
9666.210	SV	422	9666.916	VX	135	9677.115	SV	376	9677.840	SV	385
9666.213	SV	422	9666.922	SV	420	9677.160	SV	378	9677.860	SV	385
9666.220	SV	422	9666.926	VX	135	9677.165	SV	378	9677.870	SV	385
9666.223	SV	422	9666.932	SV	420	9677.180	SV	379	9677.880	SV	385
9666.230	SV	422	9666.956	VX	135	9677.200	SV	375	9677.900	SV	370
9666.240	SV	422	9666.966	VX	135	9677.210	SV	374	9677.905	SV	370
9666.250	SV	422	9674.380	SV	415	9677.215	SV	376	9677.910	SV	371
9666.260	SV	422	9674.381	SV	416	9677.260	SV	378	9677.915	SV	371
9666.270	SV	422	9674.410	SV	415	9677.265	SV	378	9677.920	SV	371
9666.280	SV	422	9674.416	SV	415	9677.280	SV	379	9677.925	SV	382
9666.290	SV	422	9674.418	SV	415	9677.300	SV	375	9680.005	VX	134
9666.293	SV	422	9674.430	SV	415	9677.310	SV	374	9680.025	VX	134
9666.300	SV	422	9674.436	SV	415	9677.315	SV	376	9680.207	VX	134
9666.303	SV	422	9674.438	SV	415	9677.340	SV	375	9680.227	VX	134
9666.310	SV	423	9674.790	SV	962	9677.360	SV	378	9680.406	VX	132
9666.340	SV	423	9674.990	SV	408	9677.365	SV	378	9680.408	VX	132
9666.350	SV	423	9676.017	SV	398	9677.380	SV	379	9680.426	VX	133
9666.380	SV	424	9676.019	SV	398	9677.400	SV	383	9680.428	VX	133
9666.390	SV	424	9676.503	SV	417	9677.402	SV	386	9680.606	VX	132
9666.400	SV	424	9676.504	SV	417	9677.405	SV	383	9680.608	VX	132
9666.410	SV	424	9676.505	SV	417	9677.407	SV	386	9680.626	VX	133
9666.420	SV	424	9676.700	SV	399	9677.410	SV	383	9680.628	VX	133
9666.430	SV	425	9676.710	SV	399	9677.412	SV	386	9680.806	VX	132
9666.440	SV	425	9676.730	SV	398	9677.415	SV	385	9680.808	VX	132
9666.520	SV	427	9676.747	SV	399	9677.418	SV	387	9680.826	VX	133
9666.530	SV	427	9676.748	SV	399	9677.420	SV	384	9680.828	VX	133
9666.533	SV	427	9676.749	SV	399	9677.425	SV	386	9681.204	SV	927
9666.550	SV	425	9676.806	SV	400	9677.430	SV	384	9681.206	SV	927
9666.560	SV	425	9676.807	SV	400	9677.435	SV	387	9681.208	SV	927
9666.570	SV	425	9676.808	SV	400	9677.440	SV	384	9681.514	SV	961
9666.580	SV	425	9676.809	SV	400	9677.445	SV	387	9681.516	SV	961
9666.583	SV	425	9676.810	SV	400	9677.450	SV	383	9681.546	SV	961
9666.590	SV	426	9676.811	SV	400	9677.460	SV	383	9681.548	SV	961
9666.600	SV	426	9676.812	SV	400	9677.470	SV	384	9681.564	SV	961
9666.603	SV	426	9676.813	SV	400	9677.480	SV	384	9681.566	SV	961
9666.640	SV	426	9676.814	SV	400	9677.485	SV	387	9681.568	SV	961
9666.650	SV	428	9676.815	SV	400	9677.500	SV	368	9681.586	SV	961
9666.660	SV	428	9676.816	SV	400	9677.511	SV	380	9681.588	SV	961
9666.665	SV	428	9676.817	SV	400	9677.521	SV	380	9681.594	SV	961
9666.670	SV	428	9676.819	SV	400	9677.531	SV	380	9681.596	SV	961
9666.680	SV	429	9676.832	SV	398	9677.541	SV	380	9681.646	SV	961
9666.702	SV	429	9676.966	SV	405	9677.550	SV	381	9681.648	SV	961
9666.703	SV	429	9676.967	SV	405	9677.560	SV	381	9681.660	SV	961
9666.704	SV	429	9676.968	SV	405	9677.570	SV	381	9681.662	SV	961
9666.705	SV	429	9676.971	SV	404	9677.580	SV	381	9681.666	SV	961
9666.706	SV	429	9676.972	SV	404	9677.600	SV	380	9681.668	SV	961
9666.707	SV	429	9676.973	SV	404	9677.610	SV	380	9681.680	SV	961
9666.711	SV	429	9676.976	SV	404	9677.620	SV	380	9681.682	SV	961

List of model numbers

9681.686 to 9792.075

Model No.		Page	Model No.		Page	Model No.		Page	Model No.		Page
9681.686	SV	961	9682.334	SV	927	9683.666	SV	413	9686.589	SV	1039
9681.688	SV	961	9682.336	SV	927	9683.668	SV	413	9686.800	SV	400
9681.806	SV	961	9682.338	SV	927	9683.680	SV	413	9686.810	SV	400
9681.808	SV	961	9682.340	SV	927	9683.681	SV	413	9686.820	SV	400
9681.826	SV	961	9682.342	SV	927	9683.682	SV	413	9686.845	SV	405
9681.828	SV	961	9682.344	SV	927	9683.683	SV	413	9686.865	SV	405
9681.846	SV	961	9682.346	SV	927	9683.684	SV	413	9686.912	SV	406
9681.848	SV	961	9682.348	SV	927	9683.686	SV	413	9686.924	SV	406
9681.866	SV	961	9682.350	SV	927	9683.688	SV	413	9765.092	CS	981
9681.868	SV	961	9682.352	SV	927	9683.701	SV	411	9765.095	CS	981
9681.886	SV	961	9682.354	SV	927	9683.702	SV	411	9765.191	CS	981
9681.888	SV	961	9682.356	SV	927	9683.703	SV	411	9783.530	CS	268
9682.104	SV	926	9682.358	SV	927	9683.704	SV	411	9783.610	CS	268
9682.106	SV	926	9683.006	SV	410	9683.706	SV	411	9784.540	CS	268
9682.108	SV	926	9683.008	SV	410	9683.736	SV	417	9785.040	CS	942
9682.124	SV	926	9683.016	SV	410	9683.738	SV	417	9785.042	CS	942
9682.126	SV	926	9683.018	SV	410	9683.763	SV	414	9791.015	CS	269
9682.128	SV	926	9683.036	SV	410	9683.783	SV	414	9791.025	CS	269
9682.140	SV	926	9683.038	SV	410	9684.004	SV	396	9791.035	CS	269
9682.142	SV	926	9683.040	SV	410	9684.006	SV	396	9791.045	CS	269
9682.143	SV	926	9683.200	SV	410	9684.008	SV	396	9792.055	AX	958
9682.144	SV	926	9683.210	SV	410	9684.010	SV	396	9792.065	AX	958
9682.146	SV	926	9683.304	SV	412	9684.012	SV	396	9792.075	AX	958
9682.148	SV	926	9683.306	SV	412	9684.900	SV	409			
9682.150	SV	926	9683.308	SV	412	9684.920	SV	409			
9682.152	SV	926	9683.310	SV	412	9684.960	SV	409			
9682.154	SV	926	9683.312	SV	412	9684.980	SV	409			
9682.156	SV	926	9683.326	SV	412	9684.990	SV	409			
9682.158	SV	926	9683.328	SV	412	9686.000	SV	395			
9682.160	SV	926	9683.406	SV	411	9686.010	SV	394			
9682.161	SV	926	9683.408	SV	411	9686.030	SV	395			
9682.162	SV	926	9683.426	SV	411	9686.040	SV	394			
9682.163	SV	926	9683.428	SV	411	9686.060	SV	396			
9682.164	SV	926	9683.444	SV	411	9686.070	SV	395			
9682.166	SV	926	9683.446	SV	411	9686.080	SV	396			
9682.167	SV	926	9683.448	SV	411	9686.100	SV	394			
9682.168	SV	926	9683.464	SV	411	9686.200	SV	397			
9682.169	SV	926	9683.466	SV	411	9686.210	SV	397			
9682.170	SV	926	9683.468	SV	411	9686.250	SV	397			
9682.172	SV	926	9683.484	SV	411	9686.260	SV	397			
9682.174	SV	926	9683.486	SV	411	9686.300	SV	1039			
9682.176	SV	926	9683.488	SV	411	9686.350	SV	1038			
9682.178	SV	926	9683.500	SV	412	9686.495	SV	405			
9682.180	SV	926	9683.504	SV	412	9686.520	SV	1038			
9682.181	SV	926	9683.506	SV	412	9686.522	SV	1038			
9682.182	SV	926	9683.508	SV	412	9686.524	SV	1038			
9682.183	SV	926	9683.561	SV	413	9686.526	SV	1038			
9682.184	SV	926	9683.562	SV	413	9686.528	SV	1038			
9682.186	SV	926	9683.563	SV	413	9686.529	SV	1039			
9682.187	SV	926	9683.564	SV	413	9686.530	SV	1038			
9682.188	SV	926	9683.604	SV	413	9686.532	SV	1038			
9682.190	SV	926	9683.606	SV	413	9686.534	SV	1038			
9682.192	SV	926	9683.608	SV	413	9686.536	SV	1038			
9682.194	SV	926	9683.624	SV	413	9686.538	SV	1038			
9682.196	SV	926	9683.626	SV	413	9686.539	SV	1039			
9682.198	SV	926	9683.628	SV	413	9686.540	SV	1038			
9682.314	SV	927	9683.642	SV	413	9686.542	SV	1038			
9682.316	SV	927	9683.643	SV	413	9686.544	SV	1038			
9682.318	SV	927	9683.644	SV	413	9686.546	SV	1038			
9682.320	SV	927	9683.646	SV	413	9686.548	SV	1038			
9682.322	SV	927	9683.648	SV	413	9686.549	SV	1039			
9682.324	SV	927	9683.660	SV	413	9686.580	SV	1038			
9682.326	SV	927	9683.661	SV	413	9686.582	SV	1038			
9682.328	SV	927	9683.662	SV	413	9686.584	SV	1038			
9682.330	SV	927	9683.663	SV	413	9686.586	SV	1038			
9682.332	SV	927	9683.664	SV	413	9686.588	SV	1038			

Index

A

Accessories			
– Data Rack	1079		
– for assembly frame	608 – 610		
– for LCP DX	785		
– for Wiring Station	621 – 628		
– Hole punches	602, 603		
– Hole punching tools	603		
– Hygienic Design	223 – 225		
– OCP	871 – 873		
Accessories – busbar machining			
– Electro-hydraulic pump	644		
– Hydraulic cylinder	645		
– Hydraulic hose	645		
– Ride-up roller	645		
Accessories for IT cooling			
– Connection hose	786		
– Fan module	787		
– Rear adaptor for LCP Inline CW	786		
Accessories for LCP CW/DX			
– Condensate pump	786		
– Shielding, vertical	786		
– Touchscreen display, colour	785		
Accommodation system, 2 U			
– for LSA installation kit	1102		
Acoustic component			
– for signal pillar, modular	1127		
Acrylic glazed cover	930		
Adaptors			
– 3 U	1090		
– 3-pole (185 mm)	372, 373		
– Blue e IoT adaptor	555		
– Circuit-breaker, 3-pole	314		
– Circuit-breaker, 4-pole	317		
– for air duct system	540		
– for connector cut-outs	908		
– for LCP Inline CW	786		
– for NH disconnectors, size 000	295		
– for spindle hoist	609		
– for support arm system	208		
– for tilt coupler	210		
– for twin castors and levelling feet	893		
– Metric to 482.6 mm (19")	1091		
– OM	307, 310, 312		
– RiLine Compact	286, 287, 289		
Adaptor bracket			
– for WS 540	624		
Adaptor kit, 3 U	1090		
Adaptor pieces, 482.6 mm (19")	1081		
Adaptor power pack for LED system light	1026		
Adaptor section, 482.6 mm (19")	1080		
Adhesive measurement strip, 482.6 mm (19")	1085		
Air baffle plates			
– for VX IT 482.6 mm (19") mounting angles, dynamic	1095		
– for VX IT 482.6 mm (19") mounting angles, standard	1094		
Air circuit-breaker support bar	412		
Air diverter	542		
Air duct	1096		
– for 482.6 mm (19") mounting level	1095		
– for wall-mounted cooling unit Blue e+ IT	784		
Air duct adaptor	540		
Air duct system			
– for air/water heat exchanger, roof-mounted	540		
– for roof-mounted cooling units	540		
Air routing			
– horizontal air routing	1095		
– side air routing	1096		
Air/air heat exchangers			
– Roof-mounted	470		
– TopTherm	469		
Air/water heat exchangers			
– Baying enclosure system VX25	518		
– Hygienic Design	515		
– Roof-mounted	516		
– Wall-mounted	510 – 514		
Aisle containment	788		
Allocation of lock systems	933 – 936		
Alternate frame, magnetic	957		
Aluminium strip TP	163, 1104		
Aluminium/sheet steel door, vented			
– for VX IT	922		
Angle bracket	405		
– for combination rail	1063		
– PE/PEN busbar system	1038		
Angle piece	1001		
Angular baying bracket	913		
Arcing chamber			
– for NH fuse-switch disconnectors	357		
Assembly components	1001		
Assembly frame			
– Mounting device	607		
Assembly parts			
– for earth straps	1033		
Assembly screws	1098		
Assembly tool			
– for cable gland HD	1057		
Attachment			
– Pole clamp, AX, AX IT	968		
Automatic door opener	817		
AX IT			
– Wall-mounted enclosures IT	719		
Base/plinth, complete			
– Sheet steel, for TP universal console	890		
– Stainless steel, for one-piece console	890		
Base/plinth, static			
– for PC, IW	890		
Basic enclosure with glazed door VX25	128		
Basic enclosures, outdoor	268		
Basic modules			
– CMC III Processing Unit	803		
– CMC III Processing Unit Compact	802		
Baying block, internal	912		
Baying bracket E-Cu	1039		
Baying bracket, internal	912		
Baying connector			
– for Data Rack	1079		
– for TS IT	913, 914		
– for VX	914		
– for VX IT	914		
Baying connector, external	912, 914		
Baying cover			
– for base/plinth VX	883		
Baying enclosure system VX25			
– Basic enclosure with glazed door	128		
– Distribution enclosure	135		
– Electronic enclosure	130		
– EMC enclosure	136		
– Fuse-switch-disconnector enclosure	134		
– IP 66/NEMA 4	131		
– IP 66/NEMA 4X	246		
– Modular enclosure	132		
– Sheet steel	116		
– Stainless steel	242		
– VX25 Blue e+ integration solution	505		
Baying enclosures			
– VX25, EMC enclosure	136		
Baying kit			
– for AX, KX	916		
– for TE/TE	916		
– VX25 to TS 8	916		
Baying plate			
– Blue e+	556		
Baying seal	914		
Baying system	911		
Bit for cordless screwdrivers	571		
Bit HD			
– Hygienic Design	224		
Bit holder			
– Magnetic	573		
– with handle, magnetic	572		
Bit set			
– with bit holder	572		
Bit set for cordless screwdrivers			
– Industry	572		
Blanking cover			
– for fan-and-filter units / outlet filters	538		
– for Network Cable Organizer	1071		
– Form 2b	409		
– ISV	428		
Blanking panel			
– Tool-free attachment, 482.6 mm (19")	1093		
Blanking panel, 482.6 mm (19")			
– Extension cover	1093		
Blanking plate, 482.6 mm (19")	1092		
Blue e			
– Chillers	526		
Blue e+			
– Chillers	522		
– Display frame	557		
– Electric condensate evaporator	543		
– Roof-mounted cooling units	504, 764		
– VX25 Blue e+ integration solution	505		
– Wall-mounted cooling units	486 – 489, 765		
Blue e+ app	559		
Board			
– RiLine Compact	284		
Bolts			
– for Maxi-PLS	403, 404		
Base configuration rail for TP	995		
Base isolator	341		
Base mounting			
– Base mounting plate for base/plinth VX, base/plinth AX, base/plinth, complete	885		
– with base mounting bracket for VX, VX IT	900		
Base mounting bracket			
– for pedestal	214		
Base trays			
– for Mini-PLS	294		
– Infill	347		
– RiLine	347		
Base/plinth			
– for areas at risk from earthquakes	1032		
– for FlatBox	891		
Base/plinth adaptor			
– for twin castors and levelling feet	893		
Base/plinth corner pieces with base/plinth trim panels, front and rear			
– Sheet steel, for AX, AX IT	888		
– Sheet steel, for VX	881		
– Stainless steel, for VX	886		
Base/plinth installation bracket			
– for base/plinth VX	885		
Base/plinth trim panels, sides			
– Sheet steel, for base/plinth AX	889		
– Sheet steel, for base/plinth VX	882		
– Stainless steel, for base/plinth VX	887		
Base/plinth trim panels, vented			
– Sheet steel, for base/plinth VX	883		
Base/plinth trim panels, with brush strip			
– Sheet steel, for base/plinth VX	882		

- Bottom-mounted adaptor
 – for enclosure internal thermostat 548
 – for hygrostat 548
 Box
 – for modular outgoing section 411
 Box terminal
 – for NH fuse-switch disconnectors 357
 – for NH slimline switch-disconnectors 387
 Bracket
 – Wall bracket AX 97, 261
 Bracket/spacer 1001
 Brush kit
 – for cable entry 1068
 – for TE 963
 – for VX IT, TE 1068
 Brush strip 1055
 – for cable entry 963
 – Super-airtight 1055
 – Vertical 1096
 Built-in keyboard 19"¼ U 1111
 Bus enclosures KX
 – Sheet steel 70
 – Stainless steel 234
 Busbar claw 398
 Busbar connection adaptors
 – Mini-PLS 294
 Busbar connectors
 – for busbars 343, 380
 – for Mini-PLS 294
 – PLS 344
 Busbar machining CW 120
 – Accessories 643 – 645
 – Busbar bending and hole-punching unit CW 120-S 640
 – Busbar cutting unit CW 120-S 641
 – Foot-switch 644
 – Mobile CW 120-M 642
 – Stationary CW 120-S 640, 641
 Busbar module
 – ISV 427
 – N/PE 426
 Busbar supports
 – 1-pole 340
 – 2-pole 340
 – 40 mm busbar systems 294
 – 60 mm busbar systems 300, 302
 – Distribution busbar system 394
 – Flat copper busbars 300
 – for 100/150/185 mm bar systems 388
 – for 185 mm busbar system 368
 – for busbar baying (rear section) 396
 – for busbar baying (roof section) 395
 – for busbar entry (rear section) 395
 – for flat copper busbars 388
 – for fuse-switch disconnecter section 415
 – for Maxi-PLS 401
 – Mini-PLS 294
 – N conductor 1039
 – PLS 302, 340
 Busbar system
 – 185 mm 369
 – Connection components 406, 407
 – Flat-PLS 394 – 397
 – Maxi-PLS 401 – 403
 – Mini-PLS 294
 – RiLine 300, 302
 – RiLine Compact 284
 Busbar terminal
 – for NH slimline fuse-switch disconnectors 384
 Busbars
 – Cover section 343
 – CUPONAL 342
 – E-Cu 342
 – Maxi-PLS 401, 402
 – Mini-PLS 294
 – PLS 344
 – with integral punchings 1038
 Bus-mounting fuse base
 – for 60 mm busbar system 323, 324
 – for Mini-PLS 295
 Cable routing bars
 – 482.6 mm (19") attachment 1067
 – for universal use 1067
 Cable routing channel
 – 482.6 mm (19") 1073
 Cable routing kit for doors 948
 Cable set
 – for OM adaptors 354
 Cable shunting ring 1064
 Cable support, hinged 1011
 Cable ties 1061
 Cable tray
 – Depth-variable 1074
 CAD data 274
 Cage nut 1002
 Cam lock
 – for operating panel 932
 – Hygienic Design 224
 Cam lock, stainless steel
 – for AX, KX E-Box 943
 Captive nuts
 – 482.6 mm (19") fastener, 1 U 1097
 Cast aluminium enclosures GA 48
 Castor module
 – for VX, VX IT 894
 Castors 893
 CAT 6 cassettes
 – for Network Cable Organizer 1070
 Central earthing point 1034
 Chiller app 558
 Chiller configurator 558
 Chillers
 – Blue e 526
 – Blue e+ 522
 – TopTherm 519
 Circuit-breaker component adaptors
 – 3-pole 314
 – 4-pole 317
 – RiLine Compact 289
 Circuit-breaker module ISV 425
 Clamp rail for cables 1059
 Clamping unit
 – for assembly frame 608
 Clamp-type terminal
 – for NH slimline switch-disconnectors 386
 Clamp-type terminal connection
 – for NH slimline fuse-switch disconnectors 358
 Claw with threaded insert 398
 Claws
 – for busbars 398
 Climate control
 – Configurators 558
 Climate control doors 507
 Clipboard 1106
 CMC III
 – Accessories 806
 – Automatic Door Opening (ADO) 816
 – CAN bus connection cable 818
 – CAN bus unit 802
 – I/O unit 803
 – LTE unit 820
 – Online comfort handle VX 946
 – Power unit 803
 – Processing Unit/Compact 804
 – Wireless Unit 815
 Coded lock 813
 Combination angle 915
 Combination pliers 587
 Combination rails
 – for 482.6 mm (19") 1074
 – for VX, VX IT 1063
 C
 C rail
 – 30/15 996
 Cable attachment 1061
 Cable chamber for VX, VX SE 884
 Cable clamp
 – for C rails 1060
 – for cable clamp rails 1059
 Cable clamp rail
 – C-section 1059
 – Right angle section 1059
 Cable clamp rail, depth-variable
 – for VX, VX IT, TE 1063
 Cable clamp strap 819
 Cable clamp strip, foam rubber 1045
 Cable clamping bracket 1060
 Cable clamping, vertical 1066
 Cable conduit/cable conduit holder 1060
 Cable cutter 585
 Cable duct 1058
 – for VX IT, TE 1068
 Cable entry gland
 – for roof plates 962
 Cable entry grommet 1044
 Cable entry module, round 1048
 Cable entry panel
 – 482.6 mm (19") 1074
 Cable entry plate 1044
 Cable finger
 – for VX IT 1069
 Cable gland
 – Brass 1056
 – EMC 1030
 – for IW worktops 1046
 – Polyamide 1056
 – Stainless steel, HD 1057
 Cable gland plate
 – Metal 1053, 1054
 – Plastic 1050, 1052
 Cable holder 1062
 Cable lock PSM 752
 Cable management enclosure
 – VX IT 701
 Cable management panel
 – with cable routing bars 1073
 – with front flap 1073
 – with plastic rings 1072
 – with steel rings 1072
 Cable manager 1064
 Cable organiser 963
 Cable route
 – for TE 1066
 – for VX, VX IT 1066
 Cable routing
 – Snap-in 1062

Index

Comfort handle	938	Condensate pump		Connection space cover	
– AX	939	– for LCP Rack/Inline CW	786	– for NH fuse-switch disconnectors	357
– AX Mini	940	Condenser for LCP CW/DX	785	– for NH slimline fuse-switch disconnectors	357, 383
– VX	937	Conductor connection clamps	349	– for NH slimline switch-disconnectors	383
– VX with code	946	– Push-in	349	Connection space cover, rear	
Comfort Panel	172, 173	Configurators		– for NH slimline switch-disconnectors	386
Command panel housing with door		– Chiller	558	Connection space extender	
– Stainless steel	254	– Command panel	273	– for bus-mounting fuse bases	356
Command panels		– DCIM	875	Connection terminal block ISV	423
– Comfort Panel	172	– IT cooling	875	Connector	
– Command panel housing with door	254	– IT infrastructure	874	– E-Cu	397
– Compact Panel	181	– Micro Data Center	874	– for busbars	343, 380
– Configurator	273	– PDU	875	– for enclosures	968
– Optipanel	174	– RiMatrix S	874	– for frame	969
– Premium Panel	253	– Rittal Configuration System	272	Connector gland	1046, 1047
– Stainless steel	253, 254	– Support arm	273	Connector grommets	1044
Compact enclosures		– VX25 Power Engineering	446	Connector kit	
– AX	94	Connection accessories		– for component adaptors	382
– Hygienic Design	222	– for LED compact system light	1026	– for Flat-PLS/Maxi-PLS	406, 407
– Plastic enclosures AX, with viewing window	95	– for LED system light	1023	Connector lock	
Compact enclosures AX		– for self-assembly	1023	– for C14 and C20 connectors	752
– Basic enclosure AX, sheet steel	84 – 91	Connection adaptors	208	Consoles	
– Basic enclosure AX, stainless steel	236 – 240	– 3-pole (185 mm)	370	– One-piece consoles TP	161
– Operating housing AX for desktop TFT up to 24"	180	– for 60 mm busbar system	304	– Universal consoles	162
– Operating housings AX with handle strips	178, 179	– for voltage supply	610	Contact cutter	1030
– with support arm connection and handle strips	178, 179	– RiLine Compact	285	Contact hazard protection	
– with support arm connection and TFT holder for desktop TFT up to 24"	180	Connection adaptor expansion set		– RiLine	347, 348
Compact infeed		– for 60 mm busbar system	306	Contact hazard protection cover plate	
– for Maxi-PLS	404	Connection block	351, 371	– for 185 mm busbar system	381
Compact Panel	181	Connection bracket		– for bus-mounting fuse bases	356
– Wall mounting bracket	969	– for circuit-breaker component adaptors	355	– for component adaptors	382
Compartment divider		– CAN bus	819	– for connection block	382
– for VX	411	– for power pack, TFT monitor	1109	– Form 2b	409
Compartment side panel		– for PSM busbars	751	Contact hazard protection module ISV	421
– for VX	410	– for SK BUS system	550	Contact paint	1030
Complete CAT 6 system		– Master/slave cable	550	Contact terminal	
– for Network Cable Organizer	1069	Connection cable for door-operated switch		– for NH slimline fuse-switch disconnectors	383
Complete earthing kits		– for LED system light	1024	– for NH slimline fuse-switch disconnectors/connection adaptors	384
– for TE	1036	Connection cable PSM		– for NH slimline switch-disconnectors	387
Component adaptors		– 3-phase	751	Contact washer	1033
– 3-pole	314	– single-phase	751	Container	856 – 861
– 3-pole (185 mm)	372, 373	Connection cable/extension	819	Cooling medium	
– 4-pole	317	Connection cables		– for air/water heat exchangers	545
– Mini-PLS	296	– for LED system lights	1026	– for chillers	545
– RiLine Compact	286, 287, 289	– for OM adaptors	354, 355	Cooling units	
– with connection cables	307	Connection clamp	349, 398	– for Micro Data Center	768, 769
– with plug-in cable outlet	312	– for laminated copper bars	350	– for network/server racks VX IT	768, 769
– with spring terminals	310	– for Maxi-PLS	403	– for refrigerant-based rack and suite cooling	774, 775
– without contact system	288	– for NH slimline fuse-switch disconnectors	384	– for water-based rack and suite cooling	780 – 783
Component shelf		– for NH slimline switch-disconnectors	386, 387	– Roof-mounted, Blue e	498
– 1 U, static installation, 482.6 mm (19")	1009	– Push-in	349	– Roof-mounted, Blue e+	504, 764
– 2 U, pull-out, 482.6 mm (19")	1010	Connection component		– Thermolectric cooler	474
– 2 U, static installation, 482.6 mm (19")	1010	– for signal pillar, modular	1123	– UL Type 3R/4	494
– for frame attachment	1006	Connection components		– Wall-mounted	475, 476
– Pull-out for TE	1009	– for air circuit-breakers and busbar connections	406, 407	– Wall-mounted, Blue e	477 – 483
– Pull-out, 482.6 mm (19")	1008	Connection console	207	– Wall-mounted, Blue e+	486 – 489, 765
– Pull-out, VX SE, PC, IW	1007	– VESA 75/100	207	– Wall-mounted, NEMA 4X	490
– Static installation for TE	1008	Connection hose		Cooling units for cooling IT equipment	
– Static installation, 482.6 mm (19")	1008	– for LCP CW	786	– Blue e+	764, 765
– Static installation, VX SE, PC, IW	1007	Connection kit for separated frame	1005	Copper bar	
Component support		Connection pin		– with integral punchings	1038
– RiLine Compact	288	– for OM adaptor/support	354	Copper busbars	
Component support, left		Connection plate	208	– E-Cu	342
– for WS 540	621	– for laminated copper bars	399	– Laminated	346
Component support, right		– for Maxi-PLS	403	– Mini-PLS	294
– for WS 540	622	– for ring terminal	399	– PLS	344
Computer Room Air Conditioner (CRAC)	793	Connection set		– Copper spacer roll	417
Condensate collecting bottle	544	– for air/water heat exchangers	545	Corner handle	1105
Condensate discharge	900	– for Flat-PLS	400	Corrosion protection primer	903
Condensate evaporator					
– Electrical	543				
Condensate hose	544				

- Cover
- Acrylic glazed 930
 - Baying, top 915
 - Baying, vertical 916
 - Blanking panel, 482.6 mm (19") 1093
 - for 185 mm busbar system 381
 - for busbar supports 396
 - for bus-mounting fuse bases 356
 - for component adaptors 382
 - for connection block 382
 - for connection clamps 350
 - for NH slimline fuse-switch disconnectors 385
 - for NH slimline switch-disconnectors 386
 - Form 1 408
 - Form 2b 409
 - Magnetic 1085
 - Tool-free attachment, 482.6 mm (19") 1093
- Cover hinge
- for terminal boxes KX 951
- Cover plate
- for connector cut-outs 908
 - for support arm connection 1107
- Cover plates
- Slotted 408
- Cover plates for fan panels
- for FlatBox 791
- Cover section
- Busbars 343
 - Mini-PLS 294
 - RiLine 348
- Cover strip
- for contact hazard protection cover 381
 - ISV 428
- Cover with door
- for VX 908
- Crane bracket 915
- Crimping machine L8
- Stripping machine 635
- Crimping machine R8 E
- Stripping machine 634
- Crimping machine RC
- Stripping machine 636
- Crimping pliers 575 - 577
- for crimp tab terminals 575
 - for ring terminals 576
 - for wire end ferrules 574, 575
- Cross member cutter 586
- Cross member for support panel 348
- Cross member for VX IT 1083
- Cross member, adjustable
- for VX, VX SE TP, PC, IW 891
- Cross rail ISV 429
- Cross-brace
- for mounting plate for VX, VX SE 974
- CUPONAL busbars 342
- Current converter
- for NH slimline fuse-switch disconnectors 385
 - for NH slimline switch-disconnectors 385
- Cutting centre
- Secarex AC 18 650
- Cutting machine
- Length-cutting machine C8+ 632
- Cutting tools 585, 586
- ## D
- Data Rack 709
- Accessories 1079
- DCIM Data Centre Infrastructure Management 830
- Deburring blade
- for Perforex machining centres BC 590
 - Steel blade 590
- Deflector, 90°
- for air duct system 540
- Depth extension frame
- for NH fuse-switch disconnectors 429
- Depth stays
- for Data Rack 1079
 - for VX IT 1083
 - ISV 430
- Desk section
- for TP universal console 163
- Digital enclosure internal temperature display and thermostat 546
- DIN rail mounted device module ISV 422
- Direct connection terminal 398
- Disconnect cross-member ISV 424
- Disconnectors
- ISV module 424
 - RiLine Compact 290
 - Size 000 295, 325, 326
 - Sizes 00 to 3 327
 - with electromechanical fuse monitoring 331
 - with electronic fuse monitoring 329
- Display
- for LCP Rack/Inline CW 785
 - Smart monitoring system 334
- Display board with wall bracket 1106
- Display frame
- Blue e+ roof-mounted cooling unit 557
 - VX25 Blue e+ integration solution 557
- Distribution busbar cover
- for fuse-switch disconnecter section 415
- Distribution enclosures
- Fibre optic, polycarbonate 720
- Distributor racks
- Data Rack 709, 1079
 - TE 8000 708
- Divider panel
- for module plates 906
- Divider panel seal, EMC for VX 1028
- Document clip, magnetic 957
- Door control
- Module 817
- Door latch
- for bayed suites 910
- Door stay AX 96
- Door stay for escape routes 956
- Door variants VX IT
- Aluminium/sheet steel door, vented 922
 - Automatic Door Opening (ADO) 919
 - Glazed aluminium door, one-piece 920
 - Glazed sheet steel door, vertically divided 920
 - Sheet steel door, one-piece, solid 921
 - Sheet steel door, one-piece, vented 922
 - Sheet steel door, vertically divided, solid 921
 - Sheet steel door, vertically divided, vented 923
- Door-operated switch
- for LED system light 1024
 - for self-assembly 1024
- Drawers
- 1 U 1114
 - 482.6 mm (19") 1091
 - 482.6 mm (19")/2 U for keyboard and mouse 1113
 - 482.6 mm (19") to accommodate excess cable length 1072
 - for keyboard and mouse, with support for mousepad 1114
 - for VX 928
 - Tray 1007
- Drilling template
- for AX 591
- D-Switch bus-mounting fuse base 324
- Dust guard trim
- for AX, KX 959
 - for VX, VX SE 959
- ## E
- Earth clamp, EMC 1030
- Earth rail 1036
- Earth straps 1033
- Earthing 1035
- Earthing braid 1033
- Earthing kit
- Earthing extension kit for potential equalisation 1035
 - for earth rail 1037
- Earthing plate 1034
- Earthing point, central 1034
- Earthquake base/plinth for VX 1032
- Earthquake kit for VX 1032
- E-Box KX
- Sheet steel 64 - 67
 - Stainless steel 232, 233
- EC speed control
- for EC fan-and-filter units 548
- Edge protection 1047
- EL wall-mounted enclosures, 3-part 715 - 718
- Electric condensate evaporator 543
- Blue e+ 543
- Electric hydraulic punch 592
- Electrician's scissors 586
- Electro-hydraulic pump
- for CW 120 644
- Electronic enclosure VX25 130
- Electronic needle-nose pliers 587
- Electronic side cutter 585
- EMC
- Cable gland 1030
 - Earth clamp 1030
 - Mounting plate for VX, VX SE 1029
 - Shield bus 1029, 1030
 - Shielding bracket 1029
 - Side panel for VX 1028
 - TopTherm fan-and-filter units 459
- EMC seal
- Divider panel seal for VX 1028
 - Shielding seal for VX 1028
- Empty enclosures 701
- Enclosure connector, adjustable 968
- Enclosure flange 214
- Enclosure heater
- with fan 531
 - without fan 530
- Enclosure internal fan 539
- Enclosure internal thermostat 547
- Enclosure key
- Hygienic Design 224

Index

Enclosure reinforcement	214	Eyebolt		Front outlet grille 2 U	
Enclosure set		– for AX	964	– for tangential fans	539
– for assembly frame	608	– for VX, VX SE	964	Front panel	
Enclosure systems				– for Comfort Panel and Optipanel	1107
– Baying enclosure system VX25,				– for Compact Panel	1107
sheet steel	116			Front trim panel	
– Baying enclosure system VX25,				– Bottom	927
stainless steel	242			– Top	927
– Distribution enclosure	135			Front-mounting cage nut,	
– Fuse-switch-disconnector enclosure	134			482.6 mm (19")	1098
– Modular enclosure	132			Fully automated wire processing machine	
– PC enclosure systems	164			– Wire Terminal WT	656
– VX IT network/server racks	686 – 699			Functional trolley	613
– VX SE stainless steel, IP 66/NEMA 4X	250			Fuse elements	
– VX SE, IP 66/NEMA 4	147			– for 60 mm busbar system	323, 324
– VX SE, sheet steel	142			– Mini-PLS	295
– VX SE, stainless steel	248			Fuse holders	337 – 339
– VX25 Blue e+ integration solution	505			Fuse-switch disconnector section	415, 416
– VX25 electronic enclosure	130			Fuse-switch disconnectors	
– VX25 with glazed door	128			– ISV module	424
– VX25, EMC enclosure	136			– RiLine Compact	290
– VX25, IP 66/NEMA 4	131			– Size 00	335
– VX25, IP 66/NEMA 4X	246			– Size 000	295, 325, 326
Enclosures				– Sizes 00 to 3	327
– Configurators	272			– Sizes 00 to 3, 185 mm	374
– Distribution enclosure	135			– with electromechanical fuse monitoring	331
– Door latch	910			– with electronic fuse monitoring	329, 336
– Fuse-switch-disconnector enclosure	134			– with fuse monitoring, 185 mm	376
– Internal temperature display and				Fuse-switch-disconnector enclosure	134
thermostat, digital	546				
– Isolator door cover	909				
– Key	945				
– Modular enclosure	132				
– TE 8000 network racks	704 – 707				
– VX IT network/server racks	686 – 699				
– VX SE stainless steel, IP 66/NEMA 4X	250				
– VX SE, sheet steel	142				
– VX SE, stainless steel	248				
– VX25 electronic enclosure	130				
– VX25 with glazed door	128				
– VX25, EMC enclosure	136				
– VX25, IP 66/NEMA 4	131				
– VX25, IP 66/NEMA 4X	246				
– VX25, sheet steel	116				
– VX25, stainless steel	242				
End cover					
– for 100 mm busbar system	389				
– for 185 mm busbar system	380				
– for busbar supports	396				
– for Mini-PLS	294				
– for PLS	303				
– for RiLine	301				
End support					
– for fuse-switch disconnector section	415				
End supports					
– for Maxi-PLS	401				
Energy-Box	1043				
Entry grommets					
– for cables	1044				
– for connectors	1044				
Equipment support connectors					
– ISV	430				
Ergoform-S handle electromagnetic					
– for TE	950				
Ergoform-S handle with numerical code					
– for TE	949				
ESD connection point	1037				
Ex enclosures	260				
– Stainless steel	258, 259				
Expansion connector PLS	345				
Extension	608				
Extension cable	819				
Extension kit					
– for Comfort component adaptor	293				
– for earth rail, vertical	1037				
Extension module					
– for Comfort component adaptor	293				
Fan expansion kit	790				
Fan module					
– for LCP Rack/Inline CW	787				
Fan mounting plate					
– for VX IT, TE	790				
Fan-and-filter units					
– TopTherm	456				
– TopTherm EMC	459				
– TopTherm with EC technology	461				
Fastening bolts					
– for base/plinth, complete and					
base/plinth, static	891				
Fastening bolts for component shelves	1011				
Feet	892, 893				
Female dies					
– Busbar machining CW 120-M	643				
– for copper processing	643				
Fibre-optic					
– Patch panels	1100, 1101				
– Shunting ring	1065				
– Small distributor, polycarbonate	720				
– Splicing boxes and accessories	1099, 1100				
Fibre-optic cable management panel	1065				
Fibre-optic cassettes					
– for Network Cable Organizer	1071				
Fibre-optic splicing box					
– with telescopic pull-out	1100				
Filler piece					
– for connection set	400				
Filter mats					
– for air/air heat exchangers	533				
– for base/plinth VX	883				
– for chillers	533				
– for cooling units	533				
– for tangential fans/front outlet grilles	533				
Fine filter mat					
– for fan-and-filter units	536				
Fire alarm and					
extinguisher system DET-AC III	823 – 825				
– Pipe kit	826				
– Sealing kit for VX IT and LCP	826				
Flat copper busbar system					
– 100/150/185 mm	388				
– 185 mm	369				
– 60 mm	300				
Flat duct extension	541				
Flat screen	1109				
FlatBox	713				
FlatBox base/plinth	891				
Flex crimping tool					
– for wire end ferrules	574				
Flow regulator valve	545				
Foam rubber cable clamp strip	1045				
Fold-out tray	1111				
– for keyboard and mouse	1111				
Foot-switch					
– Stationary CW 120-S	644				
Frame connector					
– for Comfort Panel	969				
Free-standing enclosure system VX SE					
– IP 66/NEMA 4	147				
– IP 66/NEMA 4X	250				
– Sheet steel	142				
– Stainless steel	248				
Gland plate					
– for cable entry	962				
– for compartment side panel	410				
– for EL	1054				
– for TE	899				
– Metal	1053				
– Metal, for KX	1054				
– Plastic	1052				
– Plastic gland plate, modular	1050				
– with brush strip, for EL	1055				
– with foam rubber cable clamp strip	1054				
– with membranes, plastic	1052				
– with metric knockouts, plastic	1050				
Gland plates					
– for compartment divider	412				
– for VX, VX IT, VX SE	896				
Glazed door					
– for VX	917				
– for VX IT	920				
– for VX SE	918				
Glazed door VX IT					
– Automatic Door Opening (ADO)	919				
Glazed sheet steel door, vertically divided					
– for VX IT	920				
Grommets					
– for cable entry	1044				
– for connector entry	1044				
Guide					
– for mounting plate	974				
Guide frame					
– for Vario rack-mounted fan	557				

G

H

- Handle set 1104
 - for Comfort Panel 1103
 - for Optipanel 1103
- Handles
 - Comfort handle AX 939
 - Comfort handle VX 937
 - Corner handle 1105
 - for component shelves 1011
 - for mounting plate 981
 - Handle adaptor 918
 - Mini-comfort handle AX 96, 940, 941
 - Plastic handles 942
 - T handles 943
 - U handle 1105
- Handling
 - Functional trolley 613
- Heat exchangers
 - Air/air, roof-mounted 470
 - Air/water, HD 515
 - Air/water, in VX25 518
 - Air/water, roof-mounted 516
 - Air/water, wall-mounted 510 – 514
 - Wall-mounted, TopTherm 469
- Heaters
 - for enclosures 530, 531
- Hex wrench set 570
- Hinge
 - for blanking plates 1092
 - for side panel, screw-fastened, sheet steel 902
- Hinge attachment
 - for partial mounting plate VX 977
- Hinged cable support 1011
- Hinged lid for interfaces 1118
- Hinges
 - 180° 951
 - for cast aluminium enclosures 49
 - for polycarbonate enclosures 47
- Holder for mouse 1116
- Holders
 - 1-pole 340
 - 2-pole 340
 - Distribution busbar system 394
 - for 185 mm busbar system 368
 - for busbar baying (rear section) 396
 - for busbar baying (roof section) 395
 - for busbar entry (rear section) 395
 - for busbar entry (roof section) 394
 - for cable conduit 1060
 - for fuse-switch disconnecter section 415
 - for laminated copper bars 346
 - for Maxi-PLS 401
 - for protective bar 924
 - for TFT 1110
 - PLS 340
- Hole punch set
 - for sheet steel, metric 595
 - for sheet steel, PG 595
 - for sheet steel, with triple splitting, M12 - M40 597
 - for sheet steel, with triple splitting, M16 - M40 597
 - for sheet steel, with triple splitting, PG 9 - PG 21 598
 - for stainless steel, round, with triple splitting 600
- Hole punches
 - for sheet steel, heavy connectors 602
 - for sheet steel, rectangular 601
 - for sheet steel, round 594
 - for sheet steel, special contour 601
 - for sheet steel, square 600
 - for sheet steel, round, with triple splitting 596
 - for stainless steel, round, with triple splitting 599
- Hole punching tools 592 – 603
- Hose-proof hood
 - for fan-and-filter units / outlet filters 538
- Human/machine interface
 - Configurators 273
- Hydraulic cylinder 645
- Hydraulic hose 645
- Hydraulic punch 592
- Hydraulic punch set
 - Manual 593
- Hydraulic tension screw 603
- Hygienic Design
 - Accessories 223 – 225
 - Air/water heat exchangers 515
 - Bit HD 224
 - Cable gland HD 1057
 - Compact enclosures HD 221, 222
 - Levelling feet HD 223
 - Rails for interior installation HD 225
 - T handle HD 223
 - Terminal box HD 220
- Hygrostat 547
- Interface flaps
 - for RC circuit-breaker 1117
 - Modular 1118
- Interference suppressor for fans 820
- Interior installation
 - Rail for AX 989
 - Rail for TP, HD 995
- Internal latch
 - for side panel, screw-fastened, sheet steel 902
- IoT interface 554
 - Blue e IoT adaptor 555
- IP 66/NEMA 4
 - Baying enclosure system VX25 131
 - Free-standing enclosure system VX SE 147
- IP 66/NEMA 4X
 - Baying enclosure system VX25 246
 - Free-standing enclosure system VX SE 250
- Isolator cap for screw head 1058
- Isolator door cover
 - Sheet steel 909
 - Stainless steel 909
- ISV distribution enclosures 135
- ISV installation kit
 - for AX 420
 - for VX 420
- ISV module 425, 426
- IT cooling calculator 875
- IT enclosures
 - FlatBox 713
 - Small fibre-optic distributor 720
 - VerticalBox 712
 - Wall-mounted enclosures AX IT 719
 - Wall-mounted enclosures EL, 3-part 715 – 718
- IT infrastructure
 - Configurators 874
- IT infrastructure selector 874
- IT LED system light 1027
- IT power distribution 744, 1040, 1041
- IT power supply 744, 871, 1040, 1041
- IT rack systems
 - 482.6 mm (19") fastener, 1 U 1097
 - TE 8000 704 – 707
 - VX IT 686 – 699
- Identification labels
 - for Network Cable Organizer 1071
- Identification strip 932
- Industrial bit for cordless screwdrivers
 - with long shaft 571
- Industrial bit set for cordless screwdriver
 - with long shaft 572
- Industrial Workstations 166, 167
- Inlay for plastic gland plate, modular and sealing frame, modular 1051
- Insert strip
 - for circuit-breaker component adaptors 353
 - for Mini-PLS component adaptors 353
 - for OM adaptor/support 353
- Inserted screw nut M12 1039
- Inserts for busbar supports 388
- Installation kit
 - for swing frame, large 1078
 - for swing frame, small, and partial mounting plate 1076
- Installation kit VX
 - for back-to-back mounting plates 973
- Installation module ISV 426
- Insulation stripping machines
 - Crimping machine L8 635
 - Crimping machine R8 E 634
 - Crimping machine RC 636
 - Stripping machine S22 633
- Integrated louvres 539
- Interchangeable screwdriver set 569
- Interconnecting cables
 - for lights 1026
- Interface extension with wall connection and built-in RJ45 module 1117

J

- Junction box
 - with multi-functional bracket 1042

Index

K

Keyboard	
– Built-in keyboard with touchpad	1111
– pull-out	1110
Keyboard drawer	1113, 1114
– 1 U for	
two 482.6 mm (19") mounting levels	1114
– 2 U for	
one 482.6 mm (19") mounting level	1115
Keyboard support	1115

L

Label panel	
– for signal pillar, 3-way LED and signal pillar, modular	1127
Laminated copper bar	346
Large enclosures	
– Baying enclosure system VX25, sheet steel	116
– Baying enclosure system VX25, stainless steel	242
– Free-standing enclosure system VX SE, sheet steel 142	
– Free-standing enclosure system VX SE, stainless steel 248	
– VX25 electronic enclosure	130
– VX25 with glazed door	128
– VX25, IP 66/NEMA 4	131
– VX25, IP 66/NEMA 4X	246
Laser centre	
– Perforex LC	654
LCD display	334
LED compact system light	1025
LED light strip	821
LED system light	1014
LED system light for IT	1027
LED work light	
– for WS 540	623
Length-cutting machine C8+	
– Support rail cutting machine	632
Levelling component	
– for base/plinth VX	886
Levelling feet	892, 893
– Hygienic Design	223
– with internal adjustment	892
Lifting aid for mounting plate	
– for AX	591
Lights	
– IT LED system light	1027
– LED compact	1025
– LED system light	1014
Liquid Cooling Package	
– Adaptor	786
– for industry	518
– LCP Inline CW	782
– LCP Inline DX	775
– LCP Rack CW	780
– LCP Rack DX	774
Liquid Cooling Unit	
– LCU DX, redundant	769
– LCU DX, single	768
Lock and push-button inserts	942
Lock components	917
Lock cover	944

Lock cylinder inserts	943
Lock inserts	941, 942
Lock systems	
– for console systems and industrial workstation, sheet steel	935
– for enclosures and cases, stainless steel	936
– for large enclosures and PC enclosures, sheet steel 934	
– for small enclosures, compact enclosures and operating housings AX, sheet steel 933	
Lockable and adjacent door	917
Locking bar latch	937
Locking clip for seal inserts	1051
Longitudinal connector E-Cu LT 1000	397
– Storage and transport trolley	611

M

Magazine support	
– for WS 540	625
Male and female dies for slots	644
Male dies	
– for busbars	643
– for copper processing	643
Manual hydraulic punch	592
Manual hydraulic punch set	
– 90°, M16 - M40	593
– 90°, PG 9 - PG 48	593
– straight, M16 - M63	593
Master/slave cable	
– for SK BUS system	550
Maxi-PLS	
– Busbars	401, 402
Measurement module	
– for NH fuse-switch disconnectors	333
Membrane gland plate	1052
Metal filter	
– for air/air heat exchangers	534
– for chillers	534
– for climate control door/section door	534
– for cooling units	534
Metal gland plate	1053, 1054
Meter mounting board module	426
Micro Data Center	
– Level B	846
– Level E	844
Micro Data Center configurator	874
Micro-switch	
– for NH fuse-switch disconnectors	358
– for NH slimline fuse-switch disconnectors	358
– for NH slimline switch-disconnectors	387
Milling centre	
– Perforex BC	652
Mini fan	539
Mini-comfort handle AX	96, 940, 941
Mini-comfort handle EL	949
Mini-PC holder	
– for WS 540	628
Mini-PLS busbar adaptor	
– for NH fuse-switch disconnectors size 000	295
Mini-PLS busbar systems	294

Modular climate control concept	
– Climate control doors	507
– Cooling module	506
Modular enclosure	132
Modular front design	925
Module plates	907
– for TE	899
Monitor attachment	
– for WS 540	622
Monitor housings AX	
– for desktop TFT up to 24"	180
– with handle strips	178, 179
Monitor, flat	1109
Monitor/keyboard unit, 1 U	822
Motor controller	
– RiLine Compact	291
Mounting adaptor	948
Mounting adaptor PDU	752
Mounting angles	
– C rail	996
– for FlatBox	1085
– for VX IT	1081, 1082
Mounting angles additional fastening attachment	1084
Mounting angles ISV	429
Mounting braces, vertical	
– for WS 540	623
Mounting bracket	999, 1002
– for air circuit-breaker support rail	412
– for contact hazard protection cover	408
– for interior installation	1000
– for VX IT	1082
Mounting claw for second mounting level	998
Mounting clip	997
Mounting component	
– for signal pillar	1125, 1126
– for wall/base mounting	1125
Mounting frame	
– for Network Cable Organizer	1070
Mounting kit	
– for Comfort Panel	1108
– for door-operated switch	1024
– for LED system light	1024
– for Optipanel	1108
– Magnet	1024, 1025
Mounting kit AX	
– for installation kit for swing frame, small	1076
Mounting kit magnet	
– for LED compact system light	1025
Mounting kit PSM	
– for busbar	751
Mounting kit, 2 U	1084
Mounting panel, 482.6 mm (19")	1097
Mounting plate	
– Accessories	971 – 974, 981
– Attachment for TP one-piece console, TP pedestal	981
– Cross-brace for VX, VX SE	974
– EMC for VX, VX SE	1029
– for bus enclosures KX	970
– for compartment side panel	413
– for EX enclosures	970
– for outdoor Basic enclosure	981
– for terminal boxes HD	970
– for terminal boxes KX	970
– Locatable	998
– Screw-fastened, large	998
– Screw-fastened, small	999
– Slide rail	974
– Transport handle for VX, VX SE	981
– with integral top-hat rail	999
Mounting plate attachment	
– Type A, for VX	971
– Type B, for VX	972
– Type C, for VX	973
Mounting plate infill for VX	971
Mounting plate module	421

Mounting plates	
– for cast aluminium enclosures	49
– for polycarbonate enclosures	47
– ISV module	421
Mounting rail	
– Interior installation AX	989
Mounting set	
– for connection terminal block ISV	423
Mounting unit	819, 820
Mouse holder	1116
Mousepad	
– Support	1112, 1115, 1116
Multifunction mounting kit VX, for mounting plate	974
Multifunctional enclosures	271
Multiple lock	944
Multitool	
– for AX, VX	590
Multi-tooth screw	1004

N

N/PE support	
– 2-pole	340
Needle-nose pliers	587
NEMA 4X	
– Baying enclosure system VX25	246
– Bus enclosures KX	234
– Compact enclosures AX	236 – 240
– E-Box KX	232, 233
– Ex enclosures	259
– Free-standing enclosure system VX SE	250
– Plastic enclosures AX	94
– Terminal boxes KX	230, 231
– Wall-mounted cooling units Blue e, slimline	490
Network racks	
– TE 8000	704 – 707
Network/server racks VX IT	686 – 699
NH fuse-switch disconnectors	
– ISV module	424
– RiLine Compact	290
– Size 000	295, 325, 326
– Sizes 00 to 3	327
– with electromechanical fuse monitoring	331
– with electronic fuse monitoring	329
NH measurement module	
– for NH fuse-switch disconnectors	333
NH slimline fuse-switch disconnectors	
– Size 00	335
– Sizes 00 to 3, 185 mm	374
– with electronic fuse monitoring	336
– with fuse monitoring, 185 mm	376
NH slimline fuse-switch-disconnector module	425
NH slimline switch-disconnectors	
– Sizes 00 to 3, 185 mm	377
– with fuse monitoring, 185 mm	379
Notching pliers	603
Nut	1002, 1003
Nylon loop	1061
Nylon loop cable holder	1062
Nylon tape	1061
Nylon tape holder	1062

O

OCP adaptor	871
OCP Battery Back-up Unit	873
OCP busbar	871
OCP PDU	872
OCP Power	873
OCP Power Shelf	872
OCP Power Supply Unit	873
OCP Rack	870
OCP V2 side panel	871
OM adaptors	
– with connection cables	307
– with plug-in cable outlet	312
– with spring terminals	310
OM supports	
– without contact system	313
One-piece consoles	
– Stainless steel	251
One-piece consoles TP	161
Online adaptor	948
Online conversion assistant for small enclosures KX and compact enclosures AX	274
Operating housings AX	
– for desktop TFT up to 24"	180
– with handle strips	178, 179
Operating panel	931
Optical component	
– for signal pillar, modular	1124
Optipanel	174, 175
Oscillating conveyor	
– Insulation stripping and crimping machine	637
Outdoor	
– Basic enclosures	263
– Cooling units	268
– Multifunctional enclosures	497
– Project solutions	271
– Toptec	270, 271
– Wall-mounted enclosures	270
Outdoor cooling unit	269
– Toptec	497
Outdoor housing	958
Outlet filter	
– EMC	537
– Standard	537
Overvoltage protection module Type 3	754
Overvoltage protection PSM	751
Paint	903
Paper removal flap	1116
Partial door	
– for VX	926
Partial mounting plate holder	978
Partial mounting plate VX	
– for VX, VX SE	980
– for VX, VX SE, PC, IW	975
Partial mounting plate, locatable	
– for TP	982
Partial mounting plates	
– for compartment side panel	413

Partition, horizontally divided, fastened	
– for VX IT	904
Partition, one-piece, for slide-in fixing	
– for VX IT	904
Patch panels	
– for fibre-optic splicing box, depth-variable, and fibre-optic breakout box, 1 U	1100
– for fibre-optic splicing box, lockable	1101
– for small fibre-optic distributors	1101
PC enclosure system	
– Sheet steel	164
– Stainless steel	252
PDU	732 – 740
– Accessories	752
PDU configurator	875
PDU mounting adaptor	
– for TE	752
PE busbar	1036
PE/PEN angle bracket	1038
PE/PEN baying bracket E-Cu	1039
PE/PEN busbar E-Cu	1038
Pedestal	
– Complete	212
– Modular	211
– Open	213
PEN/N/PE support	340
Perforated door strip	
– for AX stainless steel	953
Perforated mounting strip	
– for partial door	927
Perforex BC	
– Deburring blade	590
Perforex BC milling centre	652
Perforex LC laser centre	654
Pillar, small	213
PinBlock	
– for starters with increased contactor attachment	354
– for support frames (OM adaptor)	354
Pipe kit	
– for DET-AC III/EPD III	826
Pivot	210
Plastic	
– Enclosures AX	94
– Enclosures AX, with viewing window	95
– Gland plates	1050, 1052
– Handles	942
Plastic enclosures AX	
– with viewing window	95
– without viewing	94
Plastic gland plate	
– for compartment side panel	410
Plastic gland plate, modular and sealing frame, modular	1049
Plate	
– for base mounting	885
– for cable connection space	410
Plate clamps	
– for laminated copper bars	350
Pleated filter	
– Blue e+ roof-mounted cooling unit	536
– VX25 Blue e+ integration solution	536
Pliers	575 – 577, 583, 587, 588, 603
PLS busbar connectors	344
PLS busbar systems	302
PLS expansion connectors	345
PLS special busbars	344
Pole clamp	
– for AX, KX, AX plastic	968
Polycarbonate enclosures PK	44 – 46
Positioner	
– RiLine Compact	293
Potential equalisation kit	1035
Potential equalisation kit, Plus version	1035
Potential equalisation rail	1036
Potential equalisation star	1034
Power distribution	
– Configurators	446

Index

Power Distribution Unit PDU	732 – 740
– Accessories	752
Power measurement	753
Power pack	
– for CMC III monitoring system	818
– for LCD display	334
– for TFT monitor	1109
– RiLine Compact	292
Power supply	1040
Premium Panel	253
Pressure relief stopper	900
Pressure stoppers	
– for roof plates, for pressure relief	962
Primer/paint	
– Contact paint	1030
Prism terminal	
– for NH slimline fuse-switch disconnectors	384
Processing Unit Compact, CMC III	804
Processing Unit, CMC III	804
Product Scan app	274
Profile half-cylinders	942
Programming cable	818
Protective bar	924
Protective roof	
– for AX	958
PSM	744
PSM busbar	744
PSM measurement bar	
– for CMC III	747
PSM measurement modules	
– with CAN bus	749, 750
PSM socket modules	748
Punched rail	
– 18 x 39 mm	993
– 23 x 23 mm	994
– Cover, distribution busbar	416
Punched section with mounting flange	
– 14 x 39 mm	952, 990
– 17 x 73 mm	992
– 18 x 64 mm	990
– 23 x 64 mm	991
– 23 x 89 mm	991
Punched section without mounting flange,	
23 x 64 mm	993
Punching tools	592 – 603

Q

Quick-assembly block	1001
Quick-change frame	
– for roof-mounted cooling units	556
Quick-fit baying clamp, one-piece	913

R

Rack-mounted fans	
– for 482.6 mm (19")	466
Radio comfort handle VX	947
Rail mounting bracket	1002
Rails	
– Base configuration rail for TP	995
– for EMC shielding bracket and strain relief	1029
– for interior installation AX	989
– for interior installation HD	225
– for interior installation TP, HD	995
RCM measurement module for CMC III	753
Refrigerant lines	
– for LCU DX	785
Reinforcement	
– for enclosure	214
Retaining plate	
– for cable connection space	410
Ride-up roller	
– for busbars	645
– for door VX, VX SE, PC	956
RiDiag	559
RiLine busbar systems	
– Flat busbars	300
– PLS busbars	302
RiLine Compact	
– Board	284
– Circuit-breaker component adaptors	289
– Component adaptors	286, 287
– Connection adaptors	285
– Motor controller	291
– NH fuse-switch disconnectors	290
– Positioner	293
– Power pack	292
RiMatrix S	850
– Efficiency package	850, 851
RiMatrix S Selector	874
Rittal Configuration System	272
RiZone	830, 831
RJ45	
– Installation module and extension	1117
Roller conveyor	
– for assembly frame	609
Roof plate	
– for cable entry glands, for VX, VX IT	961
– IP 2X, with louvres, for VX, VX IT	961
– IP 55, solid, for VX, VX IT	961
– Two-piece, for VX, VX IT	963
– with mounting cut-out	784
Roof vent	464
Roof-mounted cooling unit Blue e+ IT bundle	764, 765
Roof-mounted cooling units	
– Blue e+	504
– TopTherm Blue e	498
Roof-mounted fans	464
– for the office sector	789
– with EC technology	465
Rubber cable clamp strip	1045

S

Safety lock	944
Scissors	
– Electrician	586
Screen, flat	1109
Screw adaptor	
– for spindle hoist	609
Screw connections	
– for Flat-PLS	400
Screw for interior installation	261
– for AX plastic	97
Screwdriver set	569
– insulated	567
– uninsulated	569
Screwdrivers	
– insulated	566
– uninsulated	568
Screws	602, 1004, 1098
– for connection brackets	405
– for connector kit	405
– M10	400, 405
– with ball bearing	602
Seal for support arm connection	1107
Seal inserts for plastic gland plate, modular and sealing frame, modular	1051
Sealing frame, modular	1048
Sealing kit	
– for VX IT	826
Secarex AC 18 cutting centre	650
Second pair of mounting angles	
– for Data Rack	1079
Sections for cable entry, centre	
– for VX, VX, SE, TP	1045
Sections for cable entry, rear	
– for VX, VX, SE, TP	1045
Selector	
– IT infrastructure	874
– RiMatrix S	874
Self-tapping screw	1004
Sensor	
– for speed control	548
Server racks	686 – 699
Server telescopic slides	1090
Service socket	1042
Set of brackets	
– for assembly frame	610
Shallow air duct system	
– for air/water heat exchanger, roof-mounted	541
– for roof-mounted cooling units	541
Sheet steel	
– Baying enclosure system VX25, basic enclosure	116 – 127
– Baying enclosure system VX25, basic enclosure with glazed door	128, 129
– Baying enclosure system VX25, electronic enclosure	130
– Baying enclosure system VX25, EMC enclosure	136
– Baying enclosure system VX25, IP 66/NEMA 4	131
– Bus enclosures KX	70
– Compact enclosures AX	84 – 91
– E-Box KX	64 – 67
– Free-standing enclosure system VX SE, basic enclosure	142 – 146
– Free-standing enclosure system VX SE, IP 66/NEMA 4	147
– Operating housings AX with handle strips	178, 179
– Terminal boxes KX, with gland plate	59, 60
– Terminal boxes KX, without gland plate	56 – 58

Sheet steel door			
– with mounting cut-out	784		
Sheet steel door, one-piece, solid			
– for VX IT	921		
Sheet steel door, one-piece, vented			
– for VX IT	922		
Sheet steel door, vertically divided, solid	921		
Sheet steel door, vertically divided, vented			
– for VX IT	923		
Shelf			
– for WS 540	621		
Shield bus, EMC	1030		
Shielding bracket	1029		
Shielding seal			
– EMC for VX	1028		
Shielding, vertical	786		
Shipping brace			
– for door VX	957		
Shunting ring	1064		
Shunting ring fibre-optic	1065		
Side cover			
– for bus-mounting fuse bases	356		
Side cutter	585		
Side panel			
– Compartment	410		
– EMC for VX	1028		
– for cable chamber	884		
– for TE 8000	903		
– for top-mounting module	960		
– Horizontally divided, for VX IT	902, 903		
– Screw-fastened, sheet steel for VX, VX IT	901		
– Screw-fastened, stainless steel for VX	901		
Signal pillar	1123		
Signal pillar, 3-way LED	1122		
Signal pillar, modular	1123		
Slide rail			
– for mounting plate	974		
– for swing frames	1078		
Slide rail VX			
– for adaptor section 482.6 mm (19")	1089		
Slide rail, heavy-duty	1087		
Slide rails			
– Depth-variable	1088		
– Depth-variable, 1 U	1089		
– for Data Rack	1079		
– for TE 8000	1088		
– Static installation, VX IT	1086, 1087		
Sliding blocks			
– for circuit-breaker component adaptors	355		
– for Maxi-PLS	403		
Sliding nut			
– for Maxi-PLS	404		
Sliding plate			
– for VX, VX IT, VX SE	896		
Slimline fuse-switch disconnectors			
– Size 00	335		
– Sizes 00 to 3, 185 mm	374, 375		
– with electronic fuse monitoring, 185 mm	376		
– with electronic fuse monitoring	336		
Slimline switch-disconnectors			
– Sizes 00 to 3, 185 mm	377, 378		
– with electronic fuse monitoring, 185 mm	379		
Slip-joint pliers	588		
Slot cover			
– for C13 and C19 slots	752		
Small enclosures			
– GA	48		
– PK	44 – 46		
– Switch housings	235		
Small enclosures KX			
– Bus enclosures KX, sheet steel	70		
– Bus enclosures KX, stainless steel	234		
– E-Box KX, sheet steel	64		
– E-Box KX, stainless steel	232, 233		
– Terminal boxes KX stainless steel, without gland plate	230, 231		
– Terminal boxes KX, with gland plate	59, 60		
– Terminal boxes KX, without gland plate	56 – 58		
Small equipment box			
– 482.6 mm (19")	1091		
Smart Lifter	616		
Smart monitoring system	333, 334		
Snap-in cable routing	1062		
Socket	1042		
Socket box			
– for LED system light	1022		
Socket strip	1040		
– for WS 540	625		
Software			
– Blue e+ app	559		
– Chiller app	558		
– RiDiag	559		
– Therm App	558		
Spacers	953		
– for roof plate	964		
Spacers for busbar supports			
– RiLine	341		
Spacing element for busbar supports	388		
Spare battery			
– for assembly frame	609		
Spare filter mats			
– for EMC fan-and-filter unit	535		
– for fan-and-filter units	535		
– for roof-mounted fans	535		
– for Thermoelectric Cooler	945		
Spare key			
Special busbars			
– Mini-PLS	294		
– PLS	344		
Speed control			
– for air/air heat exchangers	549		
– for EC fan-and-filter units	548		
– for TopTherm fan-and-filter units	549		
Splicing boxes and accessories	1099		
Splitter hole punch			
– for sheet steel, round, with triple splitting	596		
– for stainless steel, round, with triple splitting	599		
Splitter hole punch set			
– for sheet steel, with triple splitting, M12 - M40	597		
– for sheet steel, with triple splitting, M16 - M40	597		
– for sheet steel, with triple splitting, PG 9 - PG 21	598		
– for stainless steel, round, with triple splitting	600		
Splitter hole punch set, metric			
– Splitter hole punch	600		
Spring nut			
– M5	1003		
– with screws M6	1099		
Stabiliser			
– for connector kit	405		
Stabiliser for VX IT	894		
Stainless steel			
– Base/plinth corner pieces with base/plinth trim panels, front and rear for VX, VX SE, PC	886		
– Base/plinth installation bracket for base/plinth VX	885		
– Base/plinth trim panels, sides, for base/plinth VX	887		
– Base/plinth, complete, for one-piece console, stainless steel	890		
– Baying enclosure system VX25	242		
– Bus enclosures KX	234		
– Cable gland HD	1057		
– Command panel housing with door	254		
– Compact enclosures AX	236 – 240		
– E-Box KX	232, 233		
– Ex enclosures	258, 259		
– Free-standing enclosure system VX SE	248		
– One-piece consoles	251		
– PC enclosure system	252		
– Premium Panel	253		
– Support arm system CP 40	188		
– Switch housings	235		
– Terminal boxes KX, without gland plate	230, 231		
– Viewing window	931		
– VX SE, IP 66/NEMA 4X	250		
– VX25, IP 66/NEMA 4X	246		
Stand systems	211 – 214		
Standalone enclosure VX SE			
– IP 66/NEMA 4	147		
– IP 66/NEMA 4X	250		
– Sheet steel	142		
– Stainless steel	248		
Standard R-OCP V2 rack	870		
Static base/plinth			
– for PC, IW	890		
Stay			
– for door	956		
– for door and escape routes	956		
Stay for trim panel, hinged at the top	928		
Steel blade			
– for deburring blade	590		
Stepped collar	1048		
Storage and transport trolley			
– LT 1000	611		
Storage box	954		
Storage box holder			
– for WS 540	624		
Straps, earth straps	1033		
Stripping machines			
– Crimping machine L8	635		
– Crimping machine R8 E	634		
– Crimping machine RC	636		
– Stripping machine S22	633		
Stripping machine console			
– for WS 540	628		
Stripping machine S22	633		
Stripping tool			
– for cables Ø 2.5 - 11 mm	583		
– for cables Ø 4.5 - 40 mm	584		
– for cables Ø 8 - 13 mm	583		
Supports			
– for flat copper busbars	300, 388		
– for keyboards	1115		
– for mousepad	1112, 1115, 1116		
– for PLS	302		
– for small appliances	1097		
– N conductor	1039		
– Wall bracket for VX, VX SE, VX IT	967		
Support arm configurator	273		
Support arm system			
– CP 40, steel	184 – 187		
– CP 40, stainless steel	188		
– CP 60	192 – 195		
– CP 120	196 – 199		
– CP 180	200 – 203		
– CP 40/60/120/180	207		
Support frame			
– for DIN rail-mounted devices	414		
Support panel			
– for cover section	348		
Support rail cutter MC3	605		
Support rail module ISV	422		

Index

Support rails	997	Terminal boxes HD		Transport castors	
– 48 x 26 mm	996	– Hygienic Design	220	– for base/plinth VX	884
– 65 x 42 mm	997	Terminal boxes KX		– for TE	895
– 75 x 20 mm	996	– Cover hinge	951	Transport handle for mounting plate	981
– for circuit-breaker component adaptors	353	– Sheet steel, with gland plate	59, 60	Transport kit	
– for circuit-breakers	412	– Sheet steel, without gland plate	56 – 58	– for VX empty enclosures	894
– for Comfort component adaptor	293	– Stainless steel, without gland plate	230, 231	Tray, drawer tray	1007
– for Mini-PLS component adaptors	352, 353	Terminal connection		Trim frame	
– for OM adaptor/support	352	– for NH slimline fuse-switch		– for slimline cooling units	556
– for VX IT	1084	disconnectors	358	Trim panel	
Support section, height-adjustable for		Terminal studs		– Bottom	927
support arm system CP	204 – 206	– for Maxi-PLS	403	– for TP	163
Support set (stabiliser)		Terminals	349, 383, 398	– Hinged at the top	928
– for connector kit	405	– for laminated copper bars	350	– Top	927
Support strip	994	– for Maxi-PLS	403	Trim strip	
– for AX with cam lock	952	– for NH fuse-switch disconnectors	357	– for NH slimline fuse-switch	
– for VX, VX SE, AX plastic, TP, PC, IW	952	disconnectors	358, 384	disconnectors	386
Support unit, 3 U		– for NH slimline fuse-switch		– for NH slimline switch-disconnectors	386
– for LSA strips	1102	disconnectors	358, 384	Twin castors	893
Supports		– for NH slimline switch-		Twin cord	
– for Mini-PLS	294	disconnectors	386, 387	– for OM adaptors	355
Surplus cable holder	1066	– Push-in	349		
Swing frame		TFT			
– 180° hinges for VX	1078	– Monitor	1109		
– Large	1077	– Operating housing AX for			
– Small	1075	desktop TFT up to 24"	180		
– Stay	1078	TFT holder	1110		
Switch		Therm app	558		
– for NH fuse-switch disconnectors	358	Therm software	558		
– for NH slimline fuse-switch		Thermoelectric cooler	474		
disconnectors	358	Thermostat			
Switch housings		– Enclosure internal thermostat	547		
– Stainless steel	235	Threaded block	1003		
Switchgear assignment		Threaded bolts			
– Mini-PLS component adaptors	297	– for Maxi-PLS	404	U handle	1105
– OM adaptors	319 – 322	Tilt coupler	210	U nut	1003
System attachment		Tilting adaptor		UL Type 3R/4	
– 185 mm busbar systems	380	– +100°/-60°	209	– Wall-mounted cooling units	494
System cover		– +/-45°	209	Universal bracket	1004
– for connection clamps	350	Tool bag		– for AX plastic	97
System divider	895	– Configured	565	– for Ex enclosure, plastic	97
System lights	1014 – 1027	– Unconfigured	565	Universal consoles TP	
System window	929	Tool holder, round		– Sheet steel	162
		– for WS 540	627	Universal support for	
		TopConsole system TP	156 – 160	laminated copper bars	346
		Top-mounting module	960	Universal utility shelf	
		TopTherm		– for WS 540	628
		– Air/air heat exchangers	469	USB extension	1117
		– Chillers	519	Utility bar, vertically hinged	1112
		– EMC fan-and-filter units	459	Utility lectern for VX, VX SE, TP, PC	953
		– Fan-and-filter units	456		
		– Fan-and-filter units with EC technology	461		
		– VX25 chillers	528		
		– Wall-mounted cooling units,			
		horizontal format	475		
		– Wall-mounted cooling units	476		
		TopTherm Blue e			
		– Roof-mounted cooling units	498		
		– Wall-mounted cooling units	477 – 482		
		– Wall-mounted cooling units, slimline	483		
		Toroidal transformer			
		– for air/water heat exchanger,			
		wall-mounted	550		
		Touchscreen	1109	V connection terminal	
		TP		– for NH slimline fuse-switch	
		– Aluminium strip	163, 1104	disconnectors	384
		– Desk section	163	Variable modular climate control concept	924
		– One-piece consoles	161	Vario rack-mounted fan	
		– TopConsole 3-part	156	– for 482.6 mm (19")	467
		– Universal consoles	162	Vent cover	791
		Transformer		Vent trim panel, 482.6 mm (19")	1093
		– for NH slimline fuse-switch		Ventilated front panels	1093
		disconnectors	385	– Width 482.6 mm (19")	1094
		– for NH slimline switch-disconnectors	385	VerticalBox	712
		Transponder card	814	Viewing window	930
		Transponder reader	813	– Stainless steel	931
		Transport and mounting handle for		Voltage supply	
		doors VX, VX SE	957	– Connection adaptor	610
		Transport bracket	915	– for assembly frame	610
				VX IT network/server racks	686 – 699

T

T distributor for LED system light	1023
T handle HD	
– Hygienic Design	223
T handles	943
Tangential fans	
– for 482.6 mm (19")	468
T-connector kit	406
TE 8000	
– Distributor racks	708
– Network racks	704 – 707
Technical information	1128 – 1131
Telescopic slide	
– for component shelves	1011
Temperature display and thermostat	546
Temperature sensor	
– for Blue e+ cooling units,	
Blue e+ chillers	549
Tension screw	602, 603
– with ball bearing	602
Terminal block ISV	423
Terminal block assembly centre	
– Athex TC 80 CS	658
Terminal box	
– for modular outgoing section	411

U

U handle	1105
U nut	1003
UL Type 3R/4	
– Wall-mounted cooling units	494
Universal bracket	1004
– for AX plastic	97
– for Ex enclosure, plastic	97
Universal consoles TP	
– Sheet steel	162
Universal support for	
laminated copper bars	346
Universal utility shelf	
– for WS 540	628
USB extension	1117
Utility bar, vertically hinged	1112
Utility lectern for VX, VX SE, TP, PC	953

V

V connection terminal	
– for NH slimline fuse-switch	
disconnectors	384
Variable modular climate control concept	924
Vario rack-mounted fan	
– for 482.6 mm (19")	467
Vent cover	791
Vent trim panel, 482.6 mm (19")	1093
Ventilated front panels	1093
– Width 482.6 mm (19")	1094
VerticalBox	712
Viewing window	930
– Stainless steel	931
Voltage supply	
– Connection adaptor	610
– for assembly frame	610
VX IT network/server racks	686 – 699

VX SE free-standing enclosure system		Wire end ferrules, loose	
– IP 66/NEMA 4	147	– DIN colour code	581, 582
– IP 66/NEMA 4X	250	– Rittal colour code	581, 582
– Sheet steel	142	Wire pack holder	
– Stainless steel	248	– for WS 540	626
VX25		Wire reel holder	
– Basic enclosure with glazed door	128	– for assembly frame	609
– Baying enclosure system, sheet steel	116	Wire routing	
– Baying enclosure system, stainless steel	242	– Component support, left	626
– Distribution enclosure	135	– for assembly frame	608
– Electronic enclosure	130	– Mounting braces, vertical	625
– EMC enclosure	136	– Wire dispenser	637
– Enclosure, sheet steel	116	Wire Station WS 540	620
– Enclosure, stainless steel	242	Wire stripper	583
– Fuse-switch-disconnector enclosure	134	Wire Terminal WT	656
– IP 66/NEMA 4	131	Wiring bracket ISV	428
– IP 66/NEMA 4X	246	Wiring duct	
VX25 Blue e+ integration solution		– for D-Switch bus-mounting fuse base	356
– Baying plate	556	Wiring duct cutter	604
VX25 chiller		Wiring plan lectern for VX, VX SE, TP, PC	954
– TopTherm	528	Wiring plan pocket	
VX25 Power Engineering	446	– Plastic	955
		– Sheet steel for VX, VX SE, TP pedestal, PC	955
		– Sheet steel, width-variable, for AX	954
		– with transparent pouch	955
		Wiring table	
		– Wire Station WS 540	620
		Wiring trim panel	417

W

RAL colours

	Colour RAL	Designation
		Rittal Power Pink
	5002	ultramarine blue
	5018	turquoise blue
	7001	silver grey
	7015	slate grey
	7016	anthracite grey
	7022	umbra grey
	7024	graphite grey
	7030	stone grey
	7035	pale grey
	7045	telegrey 1
	9003	signal white
	9005	jet black
	9006	white aluminium
	9007	grey aluminium
	9011	graphite black

We reserve the right to further developments and technical modifications of our products. Such modifications, along with errors and printing errata, shall not constitute grounds for compensation. We refer customers to our Terms of Sale and Delivery.

Rittal – The System.

Faster – better – everywhere.

Rittal is present around the globe. We are close at hand to assist you with innovative products and comprehensive services. Harness the power of “Rittal – The System.”

- 58 subsidiaries
- 85 sales and logistics centres with 270,000 m² of storage space
- 8 production sites with 220,000 m² of production space
- Approx. 1,800 patents and designs as a testimony to Rittal’s innovative strength



ENCLOSURES

POWER DISTRIBUTION

CLIMATE CONTROL

FRIEDHELM LOH GROUP

 **Germany**
www.rittal.com

 **Argentina**
www.rittal.com.ar

 **Australia**
www.rittal.com.au

 **Austria**
www.rittal.at

 **Belgium**
www.rittal.be

 **Brazil**
www.rittal.com.br

 **Bulgaria**
www.rittal.bg

 **Canada**
www.rittal.ca

 **Chile**
www.rittal.cl

 **China**
www.rittal.cn

 **Colombia**
www.rittal.com.co

 **Croatia**
www.rittal.hr

 **Czech Republic**
www.rittal.cz

 **Denmark**
www.rittal.dk

 **United Arab Emirates
Dubai**
www.rittal-middle-east.com

 **Finland**
www.rittal.fi

 **France**
www.rittal.fr

 **Great Britain**
www.rittal.co.uk

 **Greece**
www.rittal.gr

 **Hong Kong**
www.rittal.com.hk

 **Hungary**
www.rittal.hu

 **India**
www.rittal-india.com

 **Indonesia**
www.rittal.com

 **Ireland**
www.rittal.ie

 **Israel**
www.rittal.co.il

 **Italy**
www.rittal.it

 **Japan**
www.rittal.co.jp

 **Korea**
www.rittal.co.kr

 **Lithuania**
www.rittal.lt

 **Malaysia**
www.rittal.com.my

 **Mexico**
www.rittal.com.mx

 **Netherlands**
www.rittal.nl

 **New Zealand**
www.rittal.co.nz

 **Norway**
www.rittal.no

 **Peru**
www.rittal.pe

 **Poland**
www.rittal.pl

 **Portugal**
www.rittal.pt

 **Romania**
www.rittal.ro

 **Russia**
www.rittal.ru

 **Singapore**
www.rittal.com.sg

 **Slovakia**
www.rittal.sk

 **Slovenia**
www.rittal.si

 **South Africa**
www.rittal.co.za

 **Spain**
www.rittal.es

 **Sweden**
www.rittal.se

 **Switzerland**
www.rittal.ch

 **Taiwan**
www.rittal.com.tw

 **Thailand**
www.rittal.co.th

 **Turkey**
www.rittal.com.tr

 **Ukraine**
www.rittal.com.ua

 **USA**
www.rittal.us

 **Vietnam**
www.rittal.com.vn

More international subsidiaries and agencies can be found at www.rittal.com

IT INFRASTRUCTURE

SOFTWARE & SERVICES



Rittal – The System.

Faster – better – everywhere.

- Enclosures
- Power Distribution
- Climate Control
- IT Infrastructure
- Software & Services

You can find the contact details of all Rittal companies throughout the world here.



www.rittal.com/contact

XWWW00114EN2005

ENCLOSURES

POWER DISTRIBUTION

CLIMATE CONTROL

IT INFRASTRUCTURE

SOFTWARE & SERVICES



FRIEDHELM LOH GROUP